

SDB Signal Distribution Box

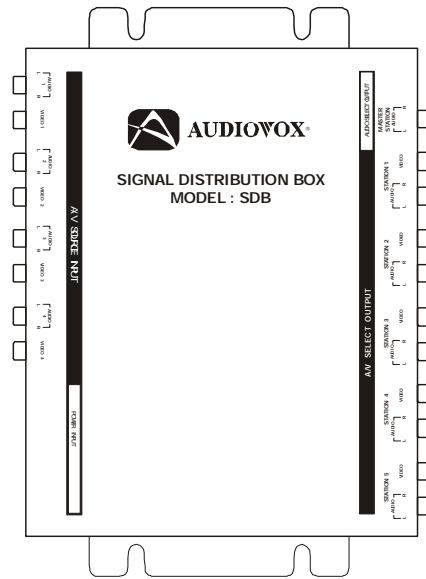

CS Control Station

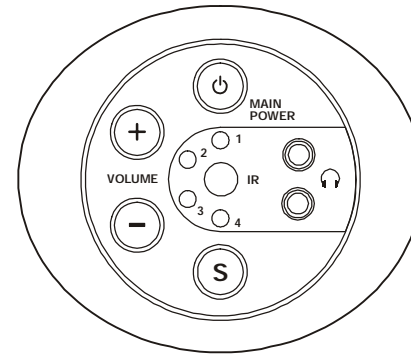

Owner's Manual

IMPORTANT NOTICE

It is unlawful in most jurisdictions for a person to drive a motor vehicle which is equipped with a television viewer or screen that is located in the motor vehicle at any point forward of the back of the driver's seat, or that is visible, directly or indirectly, to the driver while operating the vehicle.

Materials included in this package:

- | | | | |
|----|--------------|--|---------------|
| 1. | SDB | Signal Distribution Box | (1pc) |
| 2. | CS | Control Station | (2pcs) |
| 3. | CSDIN | Control Station DIN Cable | (2pcs) |
| 4. | CSSC | Control Station Source Cable + DC Power Pigtail | (2pcs) |
| 5. | SDBSC | Signal Distribution Box Source Cable | (2pcs) |
| 6. | SDBPC | Signal Distribution Box Power Cable | (1pc) |
| 7. | SDBHP | Signal Distribution Box Hardware Package
(Screws/Washers) | (1pc) |

Optional Enhancements (Not included, must be purchased separately)

- | | | |
|------------|---|--------------|
| MCS | Master Control Station
(See page 10) | (1pc) |
| GCS | Game Control Station
(See page 10) | (1pc) |

SDB45 System Overview

The SDB45 is a versatile audio/video switching system and has the capacity for four Audio/Video inputs and five Audio/Video outputs along with a separate audio output for connecting an FM modulator to the vehicle radio.

The SDB45 consists of a Signal Distribution Box (SDB) and two Control Stations (CS) along with cabling for two signal sources (SDBSC) and cabling (CSSC) for connecting two video screens.

Additional control stations (CS), Signal Distribution Box Source Cables (SDBSC), a Master Control Station (MCS) and a Game Control Station (GCS) can be purchased to further enhance the system.

Each CS is comprised of a control station, a trim ring, a DIN cable for connecting the control station to the SDB, a control station source cable (CSSC) for connecting the output of the SDB to a video screen. Each control station has a volume control and two headphone jacks for listening to the selected source. In addition, each control station has an IR sensor that allows each user to control the source component that is selected on the control station.

The Optional MCS is comprised of a master control station, a DIN cable for connecting the master control station to the SDB, a control station source cable for connecting the audio output of the SDB to an FM modulator (which is included) and a trim ring.

The MCS can switch the audio from any of the four A/V sources to the FM modulator (or to the low-level input of a receiver) so that the audio can be played through the vehicle radio. The MCS also has the capability of setting a 10-minute delay. When the delay is enabled, the system will remain on for 10 minutes after the vehicle is turned off. The MCS also has an IR sensor for controlling the source components.

(NOTE: The MCS is NOT required for the system described above.)

The optional GCS is comprised of a game control station that has RCA jacks on the front and back, a 15-foot RCA to RCA cable and a trim ring. The GCS can be used as a game port for easy access when connecting a video game, camcorder, portable DVD or other A/V input device.

The SDB45 can be used with essentially any source component and any video screen available.

(NOTE: The IR repeater in this system may not work with non-Audiovox components.)

GENERAL INSTALLATION APPROACH:

1. Decide upon system configuration and options that will be installed (i.e.: what components, VCP, DVD, TV Tuner, Video Game, Monitors, etc.).
 2. Review all manuals to become familiar with electrical requirements and hook ups.
 3. Decide upon mounting locations of all components and method of mounting.
 4. Prep the vehicle by removing any interior trim necessary to gain access to vehicle's wiring as well as all areas where interconnecting wire harnesses will need to be located. If any access holes need to be cut into the vehicle (headliner, other trim components etc.), this should be done now as well.
 5. Route the wiring harnesses throughout the vehicle as necessary. (Refer to the Wiring Diagram Sheet attached as well as the wiring instructions for the individual components and accessory options being installed). Be sure that all wiring is protected from sharp edges and is routed in such a manner that it will not be pinched when all components and interior trim are fully installed. Be sure to leave enough slack in the wiring at each component to allow working room.
 6. Remove all A/V system components from their packaging and place them loosely in the vehicle at their respective locations.
 7. Connect all components together (electrically) and verify proper operation of all system functions.
- Note:** This is best done BEFORE components have been permanently mounted.
8. After verifying proper operation of the system,

proceed to mount each component.

9. When all components are mounted recheck the entire system to be sure it is functioning correctly and ensure that no wiring was pinched or connected improperly during final installation. Use the supplied cable clamps on the control station interconnect.

VEHICLE PREPARATION

1. Locate a constant power source (+12 Vdc at all times) and an accessory power source (+12Vdc present when the ignition key is in the accessory and run positions. 0Vdc should be present when the ignition key is in the OFF position). Generally, these wires can be found at the ignition switch or fusebox. (**NOTE:** Ensure that the constant **and** accessory power are fused at their sources. Failure to do so may result in vehicle wiring damage.) Ground the Black wire to a chassis ground close to the mounting location of the SDB box.
2. The mounting method and location will vary from vehicle to vehicle, so this manual will only focus for the installation of SDB45 A/V Signal Distribution System in the package.
3. Generally, the best locations for SDB45 System components are:
 - a) SDB Trunk
 - b) MCS Door pillar near driver, dashboard or console
 - c) CS Door pillar near passenger or console
 - d) GCS Rear deck or console

Note: A template is included at the back of this manual for mounting the control station.

Output Connector Layout of the SDB

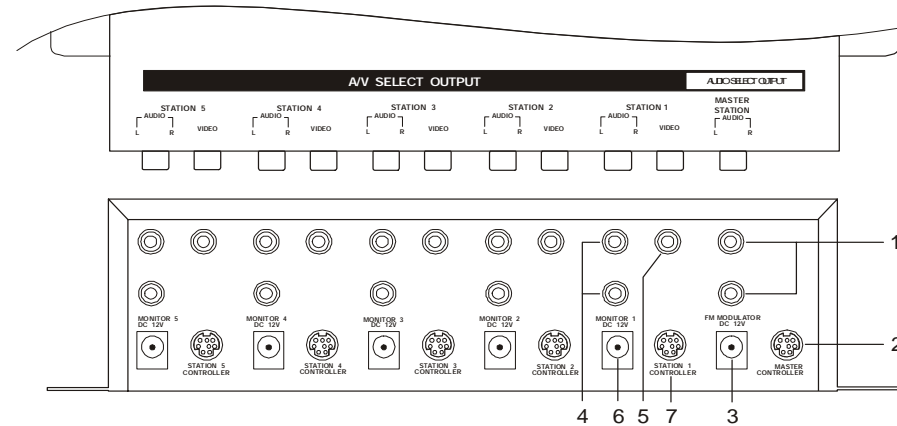

1. Audio Output L/R (RCA Jacks)

These jacks accept the red and white RCA plugs from the Master Control Station Source Cable and transmit the left and right audio output signals to the FM Modulator (MCSFMM). (**Note:** In order to route the signals to the modulator, a master control station is required. The MAIN POWER button must be pressed along with the FM POWER button on the Master Control Station.)

2. Master Control Station Input (8-pin Din)

This 8-pin jack provides the interconnection from the SDB Audio Video Signal Distribution Box to the Master Control Station.

NOTE: This cable is different from the other 5-Din cables. Be sure to use Din cable part number MCSDIN.

3. 12VDC Output for FM Modulator

This jack accepts the black barrel type power connector from the Master Control Station Source Cable. This supplies power to the FM Modulator.

4. Audio Output L/R (2-RCA Jacks)

These jacks accept the red and white RCA plugs and apply the left and right audio output signals to the user monitor; (Example LCM4000, LCM5600 etc.). Use the Control Station Source Cable (CSSC).

5. Video Output

This jack accepts the yellow RCA plug and applies the video signal to the user monitor; (Example LCM4000, LCM5600 etc.). Use the Control Station Source Cable (CSSC).

6. Monitor 1 (12VDC Output)

This jack accepts the black barrel type power connector from the Control Station Source Cable. This

supplies power to the user monitor.

7. Station 1 controller (8-pin DIN Jack)

This 8-pin jack provides the interconnection from the SDB Audio Video Signal Distribution Box to the Control Station. The cable part number is CSDIN.

Note: Items 4-7 apply to each of the five audio/video outputs.

Input Connector Layout of the SDB

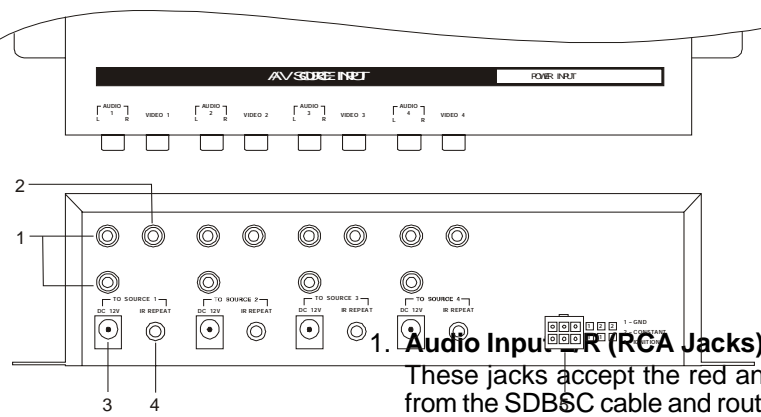

1. Audio Input - R (RCA Jacks)

These jacks accept the red and white RCA plugs from the SDBSC cable and routes the audio signals

to the SDB (Signal Distribution Box) from the source component (Example VCP, DVD etc.). Use the SDBSC cable.

2. Video Input Jack

This jack accepts the yellow RCA plug from the SDBSC cable and applies the video signal from the source component (Example VCP, DVD etc.).

3. Source Component 12 VDC Output

This jack accepts the black barrel type power connector from the SDBSC cable. (This supplies power to the source component).

4. IR Repeater Output

This jack accepts the 3.5mm mono plug of the SDBSC. (**NOTE:** The IR repeater in this system may not work with non-Audiovox components.)

5. Power Supply Input

This jack accepts the Molex 6-pin connector from the Signal Distribution Box Power Cable.



OPERATING THE SDB45 SYSTEM

(Without the Master Control Station)

Control Stations:

A. Turning the SDB45 On and Off:

1. Turn the ignition key to the ON position.
2. Press the Main Power on the Control Station (The Power symbol will light up bright red and

the volume up/down buttons and the Select button will illuminate). (Note: Some LCD screens such as the LCM0505, 0565, 4000 and 5000 require that the power button on the screen be turned on in order to view program material after the Main Power button on the control station is pressed).

3. Select the source you wish to view by pressing the "S" button on the control station. (Note: Pressing and holding the "S" button for more than six seconds will pass infrared control of the sources to the control station. The source LED will start blinking to indicate that that control station has control. A remote control can then be used to control that video source when it is pointed at the control station.
4. Turn on the source to be used (VCP, DVD etc) either manually or by the remote control for that device.
5. Plug in a set of wired headphones into the control station to listen to the selected source. Use the volume up (+) and volume down (-) buttons to adjust the volume to the wired headphones.
6. Repeat steps 1-5 for each additional control station and monitor.

Description of CS (Control Station)

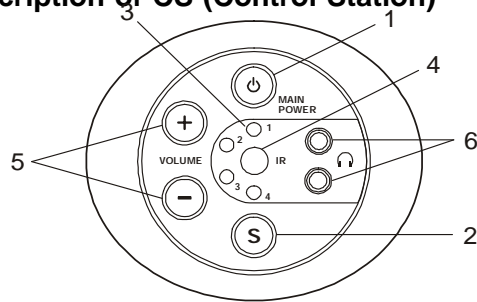

1. System Power Button

MAIN POWER (⏻) button

- Press to turn the Control Station on. The LED indicators and 1 source LED indicator will illuminate.
- Press to turn the Control Station off. The LED indicators will turn off and the MAIN POWER (⏻) (1) will dimmed.

2. Source Select Control Button

- Press the source SELECT (S) button (2) to step through the different Audio/Video Input Sources, each press button of the SELECT (S) button (2) will advance to the next input source. The source indicator LED (3) will light in the following sequences:

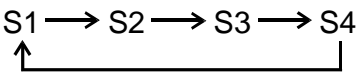

- Before attempting to operate the Remote Control, press and hold the source SELECT button (2) for 6 seconds until the source indicator LED (3) begins flashing. Once the indicator is blinking the Control Station will accept Infrared input command signals from an Infrared Remote Control device. To remove the Infrared Control function from the Control Station press and hold the button for 3 seconds.
- If source indicator LED (3) is blinking the S1 position, the Control Station has selected to control the Audio/Video Input at Source 1. To change the sources, press the source SELECT button (2) to view the following sources.

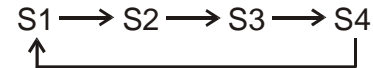

3. Source Indicator LED

- Indicates the video source that can will be viewed.

4. Remote Sensor Eye

- When the source indicator LED (3) is flashing, this indicates that the source equipment can be controlled remotely by pointing the remote control device at the remote device sensor.

5. Volume Up/Down Button

- Press the “+” button to increase headphone volume.
- Press the “-” button to decrease headphone volume.

6. Headset (3.5mm Headphone jacks)
 - These jacks provide connections for stereo headphones for private listening at each station. **(Note:** Plug the headphones in before putting the headphones on. Adjust the volume to a low level before putting the headphones on.)

Operating the SDB45 System

(With the OPTIONAL Master Control Station)

Master Control Station (MCS):

- A. The master control station is used to turn the entire system on and off. In this configuration, Control Stations cannot be turned on or off without the master control station being turned on. **(Note:** Once the master control station is turned on, follow the directions in the previous section for control station operation.)
- B. The master control station also has a power button that turns the FM modulator on and off.
- C. In addition, the master control station has a source select button that allows the user to select which of the four inputs is routed through the vehicle sound system. There is also an IR eye that allows the user to control the source through the master control station.

- D. The master control station's Main Power button has three functions:

1. **Power On** – Press and release once to turn the system on.
2. **Power Off** – Press and hold for three seconds to turn the entire system off.
3. **10 minute delayed turnoff** – Press and release once to enable the 10-minute delay (the Main Power LED will blink on and off to indicate that the SDB is in the delayed turnoff mode).

Note: For complete MCS operation see Owner's Manual included in the MCS kit.

Game Control Station (Optional)

The game control station is a set of RCA jacks that allow the user to plug in the audio/video outputs of a video game, camcorder, portable DVD or other audio/video source into the SDB45 system. It provides a readily accessible A/V input without having to access the jacks on the SDB box.

Viewing a Video Source/Video Game Using the GCS

To use the GCS, plug in the A/V source to the GCS RCA jacks, turn the source on and use the source select button (S) on the control station to access the source to which the game control station is wired.

Specifications**

Inputs	4 A/V inputs (RCA)
Input Signal Level	
Audio:	Up to 3 V p-p (10,000 ohms)
Video:	1 V p-p (75 Ohms)
Outputs	5 A/V outputs
	1 Audio Output
Output Signal Level	
Audio:	Up to 3 V p-p (10,000 ohms)
Audio S/N ratio:	Greater than 60 dB
Video:	1 V p-p (75 Ohms)
Video S/N ratio:	Greater than 55 dB
DC Input (Battery):	10 – 16 VDC (Battery wire - 10 Amps Max)
DC Input (Accessory):	10 – 16 VDC (Accessory wire – 1 Amp Max)

12 VDC Source Current Capability:

Input Source 1 through 4: 2 Amp Max each for Source Components (DVD, VCP etc.) *

Output Source 1 through 5: 1.5 Amps Max each for LCD screens, etc. *

* Each 12 VDC output jack is protected with an electronic fuse. If the current capability of the jack is exceeded, the fuse will open up. Remove the overload and wait 15 minutes for the fuse to reset. If it is necessary to supply more current than the output jack is rated, use an automotive relay. Wire the coil to the output jack and ground and hardwire the 12 V Accessory to the common terminal of the relay and wire the N.O. terminal of the relay to the load.

** Specifications subject to change without notice.

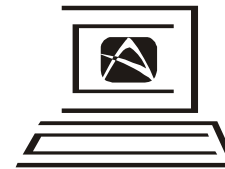
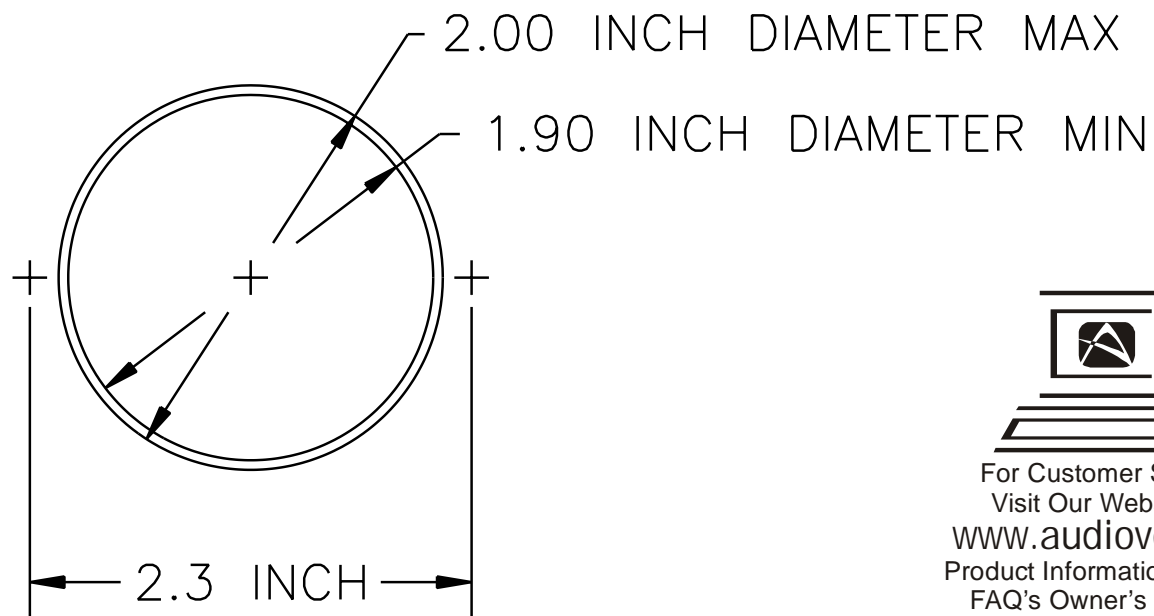

For Customer Service
Visit Our Website At
www.audiovox.com
Product Information, Photos,
FAQ's Owner's Manuals