



**P/N 60211, 60216 1996-2000
GM VORTEC 7.4 FUEL INJECTION
WIRE HARNESS INSTALLATION
INSTRUCTIONS**

Manual P/N 90541
Copyright © 2005

First Edition AUG 2005

PAINLESS PERFORMANCE PRODUCTS
2501 Ludelle Street, Fort Worth, Texas 76105-1036 (800) 423-9696

TABLE OF CONTENTS

1.0	INTRODUCTION.....	1
2.0	ABOUT THESE INSTRUCTIONS.....	1
3.0	TOOLS NEEDED.....	2
4.0	PRE-INSTALLATION AND HARNESS ROUTING GUIDELINES.....	2
4.1	TRANSMISSION FUNCTION.....	2
4.2	GET TO KNOW THE ENGINE THAT YOU ARE USING.....	2
5.0	GENERAL INSTALLATION INSTRUCTIONS.....	3
5.1	GROUNDING THE VEHICLE.....	4
5.2	ROUGH INSTALLATION.....	4
5.3	HARNESS ATTACHMENT.....	4
5.4	TERMINAL INSTALLATION INSTRUCTIONS.....	4
6.0	GM 96-00 VORTEC SYSTEM WIRE HARNESS INSTALLATION.....	5
6.1	CONTENTS OF THE 60211 & 60216 WIRE HARNESS KIT.....	5
6.2	SPECIFIC CIRCUIT CONNECTIONS.....	5
6.3	ENGINE GROUP INSTALLATION.....	7
6.4	TAIL SECTION INSTALLATION.....	11
7.0	TROUBLE-SHOOTING INSTRUCTIONS.....	12
7.1	THE "CHECK ENGINE" LIGHT.....	12
7.2	RETRIEVING TROUBLE CODES FROM THE COMPUTER.....	13
7.3	WHEN TO CALL "PAINLESS WIRING" TECH LINE.....	13

LIST OF FIGURES

Figure 6.1	Diagnostic Link Connector (DLC) & Check Engine Light	5
Figure 6.2	Brake Switch Connection	6
Figure 6.3	Brake Switch Relay.....	6
Figure 6.5	Fuel Pump Relay Connector	7
Figure 6.6	Knock Sensor Connector	9
Figure 6.7	Oxygen Sensors.....	9
Figure 6.8	MAP Sensor.....	9
Figure 6.9	CMP Sensor.....	9
Figure 6.10	CKP Sensor.....	9
Figure 6.11	Injector Connector	10
Figure 6.12	Coil Driver Connector.....	10
Figure 6.13	TPS Sensor and IAC Valve	10
Figure 6.14	Ignition Coil Connector.....	10
Figure 6.15	MAF Sensor	10
Figure 6.16	ECT Sensor	10
Figure 6.17	IAT Sensor.....	11
Figure 6.18	Fuel Pump/Oil Press. Switch.....	11
Figure 6.19	VSS/Output Speed Sensor (4L80E).....	12
Figure 6.20	Fuse Identification.....	13

LIST OF TABLES

Table 4.1	Compatible Parts V8 Engines.....	3
Table 6.1	Dash Section Connections.....	7
Table 6.2	Engine Section Connections.....	8
Table 6.3	Injector Wire Colors.....	8
Table 6.4	Tail Section Connections.....	11

1.0 INTRODUCTION

You have purchased what we at Painless Performance Products believe to be the most up-to-date and easiest-to-install automotive fuel injection harness on the market. It is designed for easy installation, even if you have no electrical experience.

This harness is designed to be a complete wiring system for the fuel injection system on General Motors 1996-2000 7.4 engines. Also, to control the **4L80E** automatic transmission using the 1996-1997 computer Service **#16229684** and **#16244210**. This includes all wiring that is needed by the computer to run and control the injection system and transmission. This harness will get the Vortec engine and transmission up and operating but it is recommended that you also have the computer reprogrammed to remove anything in the original factory programming that relates to a device or devices that are not being used in your particular vehicle.

NOTE: Most likely the check engine light will come on and stay on when using a computer with the original factory programming this is normal and is why we recommended that the computer be reprogrammed.

NOTE: Most remanufactured computers come without any programming in them and must be programmed before they can be used.

NOTE: The program in your computer must match the transmission that you plan on using. The 60211 & 60216, require the use of a 4L80E transmission. If any other electronic transmission is used, a stand alone control system is required.

Usually, the computer, relays and fuse block can easily be mounted under the dash. Most of the wiring in the harness has been pre-terminated to the proper connector and all wire has been GM color-coded. All wiring is TXL, 600 volt, and 125 degree centigrade with cross-link insulation.

This fuel injection system harness has been divided into three major groups:

ENGINE GROUP	Includes wiring for the fuel injectors, ignition system, and sensors.
DASH GROUP	Includes ignition feed wire, assembly line diagnostic link (DLC) connector, check engine light, computer connectors, brake switch wiring, tachometer wiring, VSS Signal wire, fuse block, and fuel pump relay connector.
TAIL GROUP	Include VSS wiring, transmission wiring and power wire for fuel pump.

2.0 ABOUT THESE INSTRUCTIONS

These instructions provide information for the installation of the 60211& 60216 Vortec Fuel Injection Harness Kit. The contents of these instructions are divided into major **Sections**, as follows:

1.0	INTRODUCTION
2.0	ABOUT THESE INSTRUCTIONS
3.0	TOOLS NEEDED
4.0	PRE-INSTALLATION AND HARNESS ROUTING GUIDELINES
5.0	GENERAL INSTALLATION INSTRUCTIONS
6.0	60211 VORTEC FUEL INJECTION HARNESS KIT
7.0	TROUBLE-SHOOTING INSTRUCTIONS AND TROUBLE CODES

Sections are further divided into **Paragraphs** and **Steps**. Throughout, the **Figure** numbers refer to illustration and the **Table** numbers refer to information in table form. These are located in or near the sections or paragraphs to which they correspond. Always pay careful attention to any notes or any text labeled **CAUTION**.

3.0 TOOLS NEEDED

In addition to your regular tools, you will need, at least, the following:

Crimping tool	NOTE: USE A QUALITY TOOL TO AVOID OVER-CRIMPING.
Wire stripper	
Continuity tester	CAUTION: DO NOT USE A TEST LIGHT TO TEST THE COMPUTER OR SENSOR WIRING OR YOU WILL DAMAGE THE COMPUTER.
Electric drill	
1 5/8" Hole saw (for the rubber grommet in the firewall)	

4.0 PRE-INSTALLATION AND HARNESS ROUTING GUIDELINES

The installation of your harness kit will consist of two parts:

- ~ The physical routing, positioning, and securing of the harness, wire groups, and individual wires and connectors.
- ~ The proper electrical connection of the individual circuits.

We cannot tell you how to route the harness in your automobile. That depends a great deal upon the particular make of the automobile and what extent you want to secure and conceal the harness. We do offer some general guidelines and routing practices starting in **Paragraph 5.3**, general installation instructions in **Section 5.0**, and precise instruction concerning the electrical connections you will have to make beginning in **Section 6.0**. To help you begin thinking through the installation of your wire harness, read the following sections:

4.1 TRANSMISSION FUNCTION

- 4.1.1 If you are using the 4L80E transmission, you must use the vehicle speed sensor (VSS), and the correct brake switch. These are necessary to make the transmission work correctly. The vehicle speed sensor lets the computer know how fast the wheels are turning. The brake switch should be closed (electrically connected) when the brakes **ARE NOT** being applied and open (not electrically connected) when the brakes **ARE** being applied. This is the opposite of a standard brake light switch. If you are using a pressure brake switch, a **SPDT** relay must be installed to unlock the converter when the brakes are applied. See **Figure 6.3**

4.2 YOU SHOULD GET TO KNOW THE PARTICULAR ENGINE YOU ARE USING:

NOTE: The 96-00 7.4 had four oxygen sensors from the factory, but the harness has provisions for only two, one on the driver side and one on the passenger side of the engine. We removed the rear oxygen sensors since they originally were behind the catalytic converters and most people don't want to run more than two oxygen sensors. This system has four rectangular connectors at the computer. A #16229684 computer is required for proper operation.

- 4.2.1 PPPI recommends the use of the following parts. See **Table 4.1**. These will meet all requirements and are compatible with PPPI harnesses. The numbers given are GM and AC Delco part numbers. **You must use the computer listed on table 4.1 with our harness.**
- 4.2.2 Familiarize yourself with the harness by locating each of the harness groups and by looking at the connectors on the wire ends.
- 4.2.3 Decide where and how the computer, fuse block and relays will be mounted. PPPI wire harness kits are designed to mount the computer either under the dash or in the kick panel on the right side. They must be no further apart than the wiring will allow (approx. 18 inches).
- 4.2.4 A good exercise is to lay out the wire harness on the floor beside your vehicle and identify all the connectors and wires.
- 4.2.5 You will want to route the harness through and around open areas. Inside edges provide extra protection from hazards and also provide places for tie wraps, clips and other support.

- 4.2.6 Route the harness away from sharp edges, exhaust pipes, and the hood, trunk and door hinges.
- 4.2.7 Plan where harness supports will be located. Use a support approximately every 6 inches unless the harness routes under the floor carpet.
- 4.2.8 Allow enough slack in the harness at places where movement could possibly occur (body to frame, frame to engine, etc.).
- 4.2.9 The wires should be bundled into harness groups. Use tape, nylon ties or poly split loom.

(96-00) Vortec 7.4 Fuel Injection Harness- Part # 60211

Main Computer	Service # 16229684	Idle Air Control Motor	Delco #217-435
	Service # 16244210	Knock Sensor	Delco #213-324
Brake Switch	Delco #D1565E	Coil	Delco #D577
Intake Air Temperature	Delco #213-243	Cam Position Sensor	Delco #213-920
Mass Air Flow Sensor	Delco #213-252	Crankshaft Position Sensor	Delco #213-946
Engine Coolant Temperature	Delco #213-310	VSS (4L80E)	GM #24203876
Oxygen Sensor (Drv. Side)	Delco #AFS93	Oil Pressure Switch	GM #12553175
Oxygen Sensor (Pass. Side)	Delco #AFS 93	Manifold Absolute	
Throttle Position Sensor	Delco #213-912	Pressure Sensor	Delco #213-351
Ignition Module	Delco #D579		

Table 4.1 Compatible Parts For V8 Engines

5.0 GENERAL INSTALLATION INSTRUCTIONS

CAUTION:

- ~ DO NOT DISCONNECT THE BATTERY OR THE COMPUTER CONNECTORS WHILE THE IGNITION IS ON.
- ~ DO NOT SHORT ANY WIRES IN THIS HARNESS TO GROUND (WITH THE EXCEPTION OF LABELED GROUND WIRES) OR DAMAGE TO THE COMPUTER WILL RESULT.
- ~ GIVING OR RECEIVING A "JUMP START" MAY DAMAGE THE COMPUTER.
- ~ DO NOT USE A TEST LIGHT WHEN TESTING COMPUTER SENSORS OR COMPUTER CIRCUITS. DAMAGE TO THE COMPUTER WILL RESULT!
- ~ WHEN ROUTING THE WIRES FOR THE VEHICLE SPEED SENSOR (IF USED) MAKE CERTAIN THAT THEY ARE AT LEAST 12 INCHES AWAY FROM ANY IGNITION WIRING (SPARK PLUG WIRES, ETC.).

Notes:

- ~ There is a normal, small current drain on these fuel injected systems.
- ~ NEVER FORCE ANY CONNECTOR.
- ~ When connecting the plugs to the computer USE EXTREME CARE to make sure none of the pins in the computer are or become bent.
- ~ The fuel pump and pressure regulator MUST maintain a constant pressure of 56-62 PSI (pounds per square inch).

5.1 GROUNDING THE VEHICLE

A perfectly and beautifully wired automobile will never the less have problems if everything is not properly grounded. Don't go to the effort to installing a quality wire harness only to neglect proper grounding.

Note: The installer of this harness is responsible for all ground wires not provided with this part.

5.1.1 Connect a ground strap or cable (minimum of a 4 Ga. wire) from the negative battery terminal to the chassis (frame).

5.1.2 Connect a ground strap (minimum of a 4 Ga. wire) from the engine to the chassis (frame). **DO NOT RELY UPON THE MOTOR MOUNTS TO MAKE THIS CONNECTION.**

5.1.3 Connect a ground strap from the engine to the body.

5.2 ROUGH INSTALLATION

CAUTION: DISCONNECT THE POWER FROM YOUR VEHICLE BY REMOVING THE NEGATIVE BATTERY CABLE FROM THE BATTERY.

Note: Make no wire connections or permanent mounting of any kind at this time.

5.2.1 Position the computer and sensors in their intended locations.

5.2.2 Drill a 1-5/8" hole for the firewall grommet near the computer for the engine group and tail section to pass through.

5.2.3 Route the engine group and tail section through the hole. Push the grommet (already installed on the harness) into the hole until it is seated.

5.2.4 Route the dash group over to the driver's side of the car.

5.2.5 Route the fuse block and relays to the place they will be mounted.

5.3 HARNESS ATTACHMENT

Note: Harness routing and shaping will be a time-consuming task. Taking your time will enhance the beauty of your vehicle. Please take your time and be patient.

5.3.1 Permanently mount your computer. You should mount the fuse block and relays at this time.

5.3.2 Mold harness groups to the contour of the dash, engine, frame, etc. Remember to route harness away from sharp edges, exhaust pipes, hinges, and moving parts.

5.3.3 Attach harness groups to your automobile with clips or ties starting at the computer and working your way outward.

Note: Do not tighten tie wraps or mounting devices at this time. Make all harness attachments LOOSELY.

5.3.4 When used every 1-1/2" or so on the visible areas of the harness, colored plastic wire ties make a very attractive assembly. Otherwise, a tie installed in other areas every 6" or so will hold the wires in place securely. **REMEMBER TO TAKE YOUR TIME.**

5.4 TERMINAL INSTALLATION INSTRUCTION

Note: In the following steps you will be making the circuit connections. Before you start, you should carefully read Sections 6.0, and continually refer to the wire charts, DOUBLE CHECKING your length calculations before cutting any wire or making any connections. These directions are for the wires, which do not have a connector already, installed on them.

5.4.1 Have all tools and connectors handy.

5.4.2 Select the correct terminal for the wire and application.

5.4.3 Determine the correct wire length and cut the wire. Remember to allow enough slack in the harness and wires at places where movement could occur. **DOUBLE CHECK YOUR CALCULATIONS.**

5.4.4 Strip insulation away from wire. Only strip as much insulation off as necessary for the type of terminal lug you are using.

Note: In the following step, make sure that the terminal is crimped with proper die in the crimping tool. An improper crimp will not make a good connection. **DO NOT OVER-CRIMP.**

5.4.5 Crimp the terminal onto the wire.

5.4.6 Connecting the wires and connectors throughout the harness is a simple process. Make sure that each wire is properly routed and then attached. **DO NOT ATTACH THEN ROUTE AFTERWARD.**

5.4.7 When all the wires are attached, tighten the mounts and ties to secure the harness permanently.

5.4.8 Attach the connectors to the computer. **BEING VERY CAREFUL NOT TO BEND ANY PINS.**

5.4.9 After all connections have been made throughout the harness, connect the battery to the vehicle.

CAUTION: **BE SURE THE IGNITION IS OFF WHEN YOU RECONNECT THE BATTERY OR YOU WILL DAMAGE THE COMPUTER.**

6.0 96-00 7.4 VORTEC SYSTEM WIRE HARNESS INSTALLATION INSTRUCTIONS

6.1 CONTENTS OF THE 60211 & 60216 WIRE HARNESS KIT

Take inventory to see that you have everything you are supposed to have in this kit. If anything is missing, contact the dealer where you obtained the kit or contact Painless Performance at 800-423-9696. The kit should contain the following items:

- ~ The main wire harness with the connectors already on the ends of most of the wires.
- ~ Fuel Injection Installation Instructions P/N 90541 (This Booklet).
- ~ 4" & 7" tie wraps.

6.2 SPECIFIC CIRCUIT CONNECTIONS

Note: If you have not already done so, read sections 4.0 and 5.0 of these instructions and think through the installation of the harness before securing or cutting any wires. Wire color (Example: Blk/Wht) is one wire with a stripe. The second color (the stripe) may not be bold. Observe all two-color wires closely.

6.2.1 DASH SECTION INSTALLATION

The wires in this group consist of the diagnostic link connector (DLC) (SEE **FIGURE 6.1**), the check engine light (pre-mounted into a mounting bracket), fuseblock/w fuses and relays, fuel pump relay connector/w relay and 7 other wires.

Note: You may need to connect the check engine light wires to their mates in the wire harness.

CAUTION: **DO NOT MAKE ANY CONNECTIONS WHILE THE COMPUTER IS PLUGGED INTO THE HARNESS.**

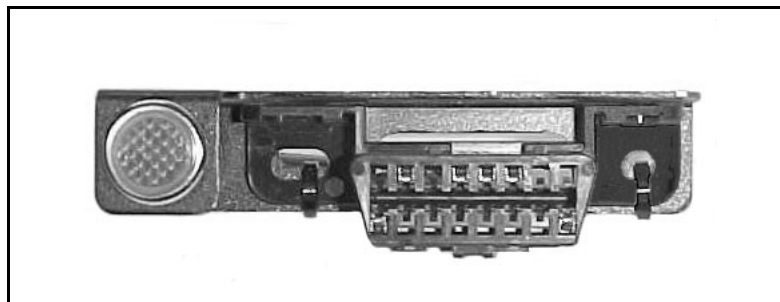

FIGURE 6.1 DLC Connector & Check Engine Light

- A. Find a suitable location to mount the DLC connector (using the bracket that the light is mounted in) that will allow access to the front of the connector and still allow you to see the light while driving.
- B. Mount the DLC connector using the bracket containing the check engine light in the place selected.
- C. Locate the white ignition hot activation wire, labeled FUSE BLOCK IGNITION (18 Ga.) and attach it to a 12V **fused** power source where there is power **WHEN THE KEY IS IN THE START AND RUN POSITION**. This wire activates the relays that supply power to all the ignition hot circuits in the fuel injection harness. If the white wire is connected correctly, the check engine light will come on when the ignition switch is in the **"ON and START"** position.
- D. The purple and brown wires labeled BRAKE SWITCH are the wires that connect to the brake switch to let the computer know when the brake is applied. If you **ARE NOT** using a 4L80E then you will tape off and store these wires. If you **ARE** using the 4L80E transmission, then you will have to install a brake switch. The brown wire provides power for this switch and the purple wire is the signal going to the computer.
- E. If you are using the recommended brake switch then you will wire it according to **Figure 6.2**. The brown wire to the back of the switch in the illustration is the wire that has power on it whether or not the brake is being applied.

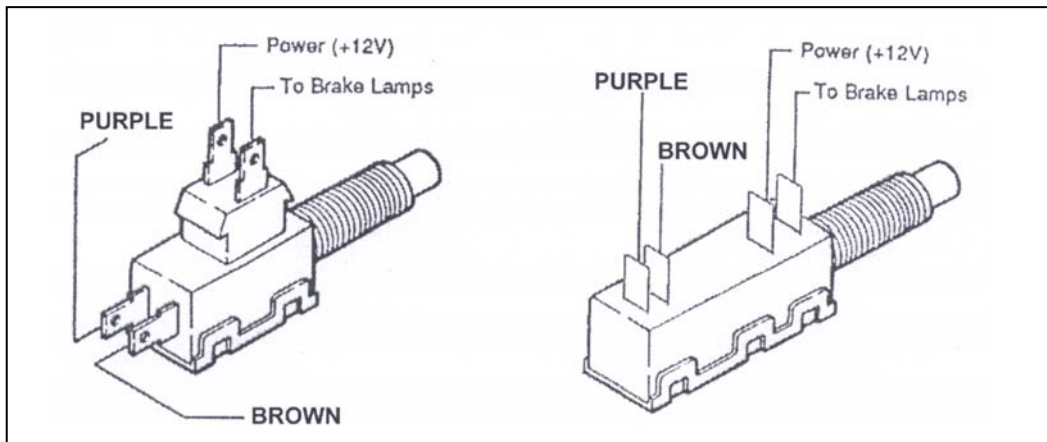

FIGURE 6.2 Brake Switch Connection

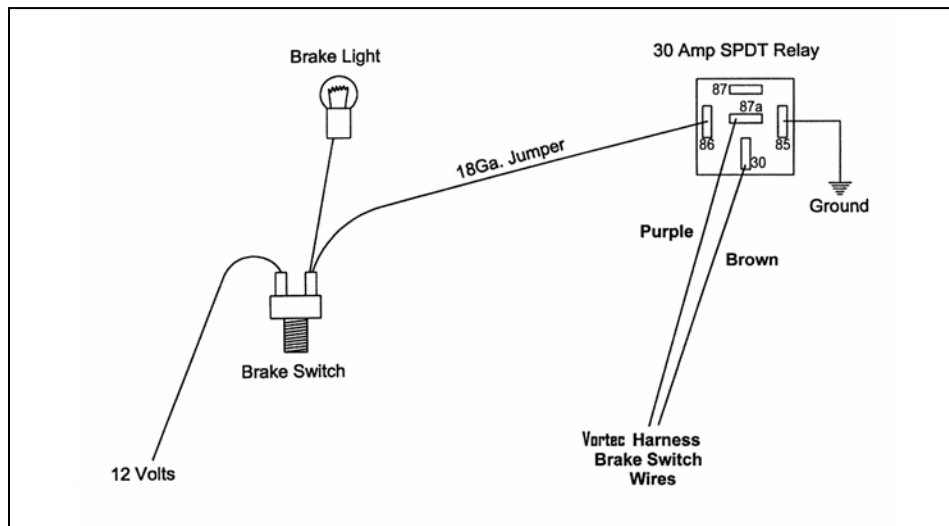

FIGURE 6.3 Brake Switch Relay

CAUTION: FAILURE TO WIRE THIS SWITCH CORRECTLY WILL RESULT IN A DANGEROUS SITUATION ON THE VEHICLE.

- F. If your vehicle has a pressure type brake switch, you may use a relay as shown in **Figure 6.3**. The relay must be a **SPDT Relay** and wired correctly or it could result in a dangerous situation with the vehicle. The torque **converter may not unlock**.
- G. The wire labeled FUEL TEST is a test point for the fuel pump. After the vehicle has been wired and tested OK, tape off this wire and store it in the harness.
- H. The wire labeled TACH (white) is the signal wire for a tachometer if used.
- I. The VSS output wire (green) sends out a signal to operate the electronic cruise control or speedometer if so equipped.

6.2.2 Dash Section Connections

WIRE COLOR	# OF POSITIONS IN CONNECTOR	LABELED	CONNECT TO:
Gray, Grn/Wht, Blk/Wht, Org, Red	5	Fuel Relay	Fuel Pump Relay
Green		VSS Output	Speedometer
White		Tach	Tachometer
Purple, Brown		Brake Switch	Brake Switch
White		Fuse Block Ignition	Ignition Power

Table 6.1 Dash Section Connections

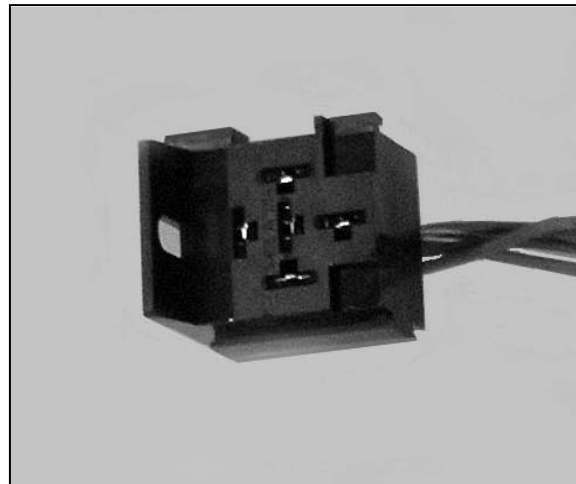

FIGURE 6.5 Fuel Pump Relay Connector

6.3 ENGINE GROUP INSTALLATION

The engine group is designed to be separated into left side (passenger) and right side (driver) sections. Each side is tie-wrapped separately, **BUT NOT LABELED**. The left side of the engine has the connectors for the idle air control and throttle position sensor, all of which **ARE** labeled. When you begin routing, **FIRST** separate the engine group into left and right sections and place them accordingly.

- 6.3.1 Before you connect any wires, separate the tail section from the engine group and place it out of the way.
- 6.3.2 Connect the two ring terminals labeled STARTER B+ with Red wires to the large battery terminal on the starter solenoid.
- 6.3.3 Locate the two large ring terminals with Black and Blk/Wht wires and ground them to the engine.
- 6.3.4 Using **Figure 6.6-6.18**, and the specific connections indicated in **Table 6.2**, connect the wiring as directed.

6.3.5 Engine Section Connections

WIRE COLOR	# OF POSITIONS IN CONNECTOR	LABELED	CONNECT TO:
Blue	1	Knock	Knock Sensor Connector
Tan/White, Purple/White, Black, Pink	4	O2 SENSOR	Driver Side Oxygen Sensor
Tan, Purple, Black, Pink	4	O2 SENSOR	Passenger Side Oxygen Sensor
Black, Lt.Green, Gray	3	MAP	MAP Sensor
Brown/White, Pink, Pink/Black	3	Dist.	Cam Position Sensor
Yellow, Purple, Pink	3	CPS	Crankshaft Position Sensor
See NOTE: Below For Injector Wire Colors	16	Injector V8	Central Port Injector
Black, Blue, Grey	3	TPS	Throttle Position Sensor
Pink, Yellow, Black/White	3	MAF	Mass Airflow Sensor
Yellow, Black	2	ECT	Engine Coolant Temp Sensor
Tan, Black	2	IAT	Intake Air Temp Sensor
Lt.Green/Black, Lt.Blue/Black, Lt.Blue/White, Lt.Green/White	4	IAC	Idle Air Control Motor
Pink, White, Black/White, White/Black	4	Coil Driver	Coil Driver Connector
Pink, White, White/Black	3	Coil	Coil Connector
Black/White, Black		Ground	Engine Ground
Red (2)		Starter B+	Starter Solenoid Batt. Terminal

TABLE 6.2 Engine Section Connections

Injector Wire Colors

Black	Injector #1	Black/White	Injector #5
Lt.Green/Black	Injector #2	Yellow/Black	Injector #6
Pink/Black	Injector #3	Red/Black	Injector #7
Lt.Blue/Black	Injector #4	Blue/White	Injector #8

TABLE 6.3 Injector Wire Colors



FIGURE 6.6 *Knock Sensor Connector*

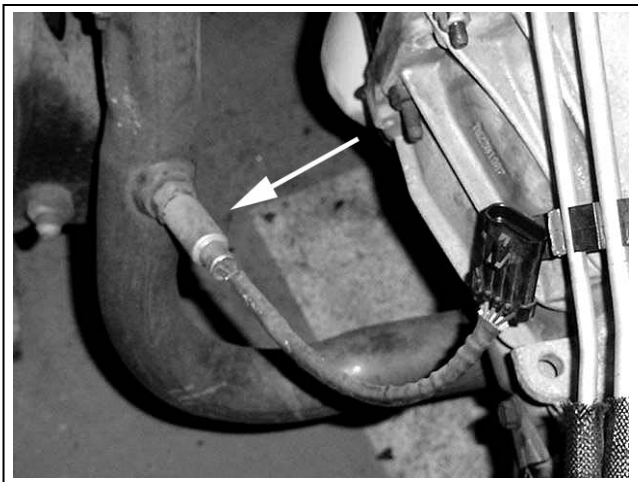

FIGURE 6.7 *Oxygen Sensors*



FIGURE 6.8 *MAP Sensor*

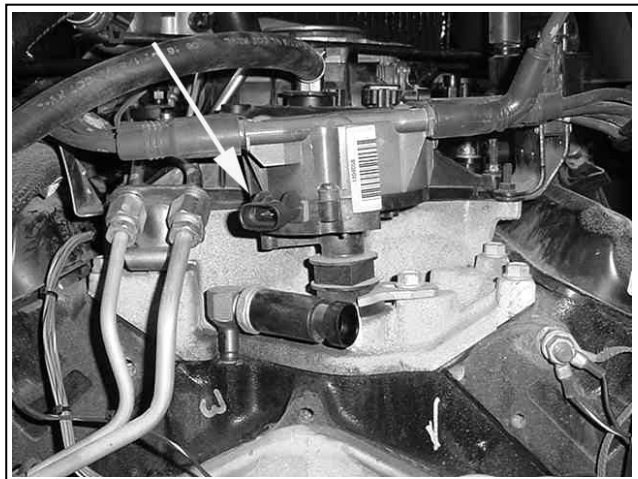

FIGURE 6.9 *Cam Sensor (Dist.)*

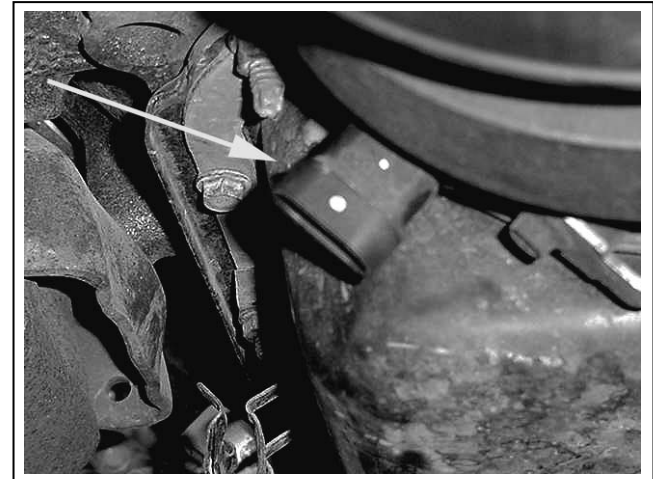

FIGURE 6.10 *CPS Sensor*

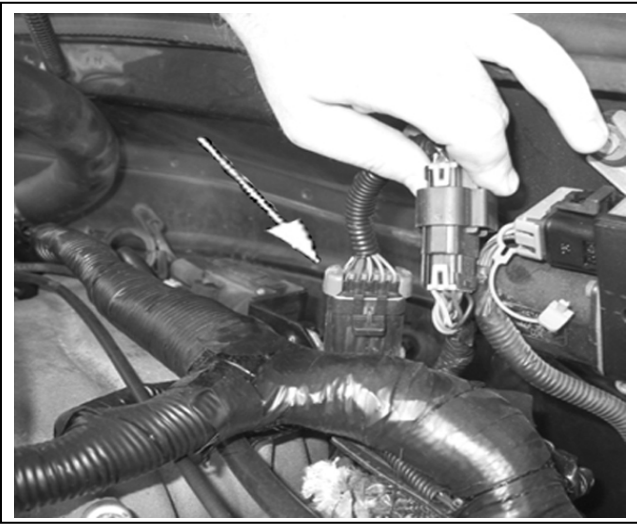

FIGURE 6.11 *Injectors 1 - 8*

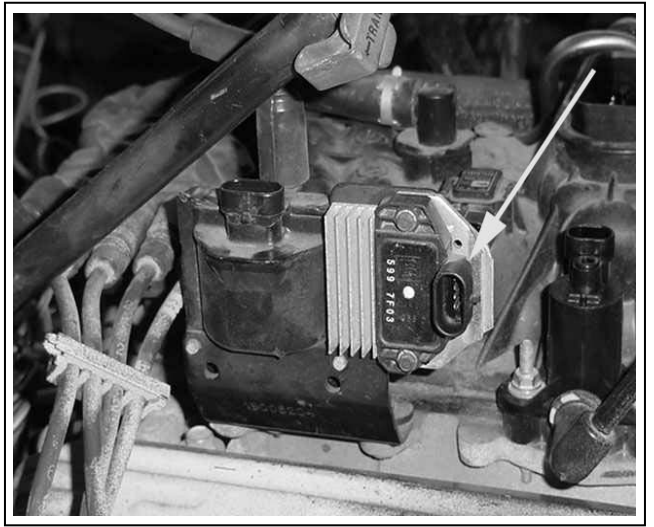

FIGURE 6.12 *Coil Driver* (Component is pictured on a 5.7. This image is used to show connector plug in, not component location)

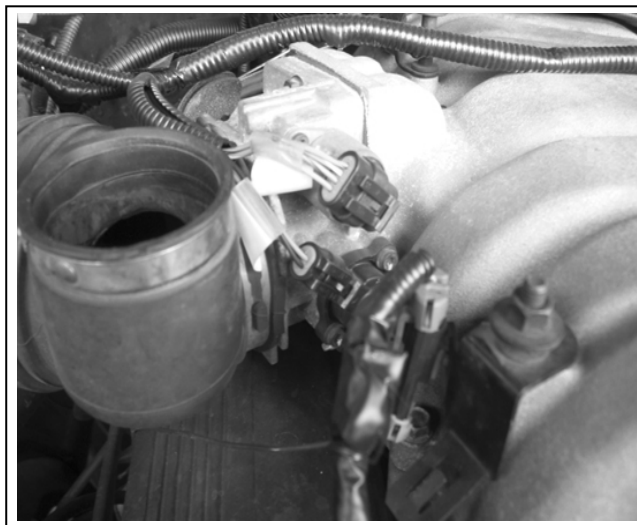

FIGURE 6.13 *TPS Sensor and IAC Valve*

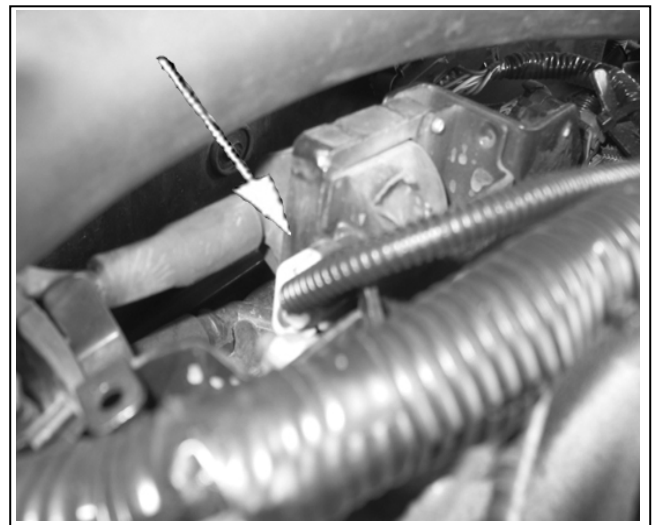

FIGURE 6.14 *Ignition Coil*

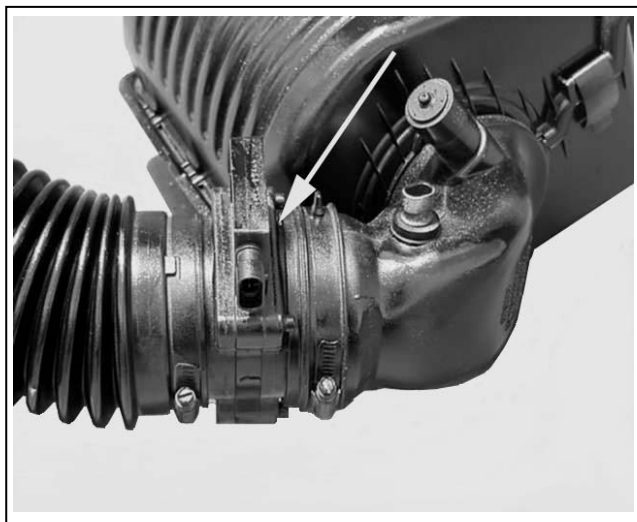

FIGURE 6.15 *MAF Sensor*

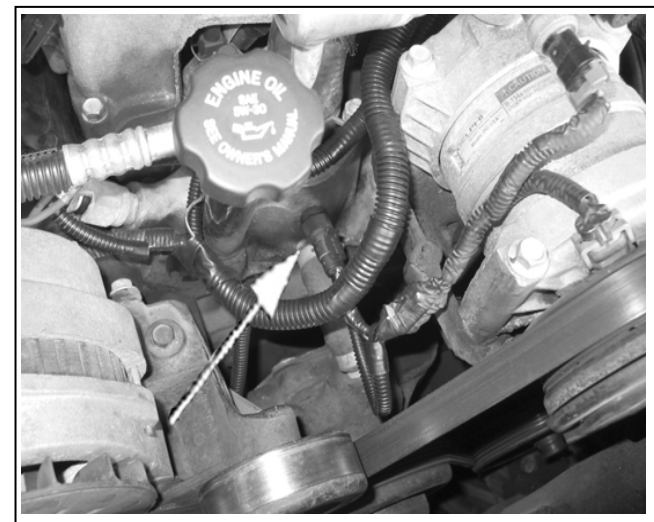

FIGURE 6.16 *ECT Sensor*

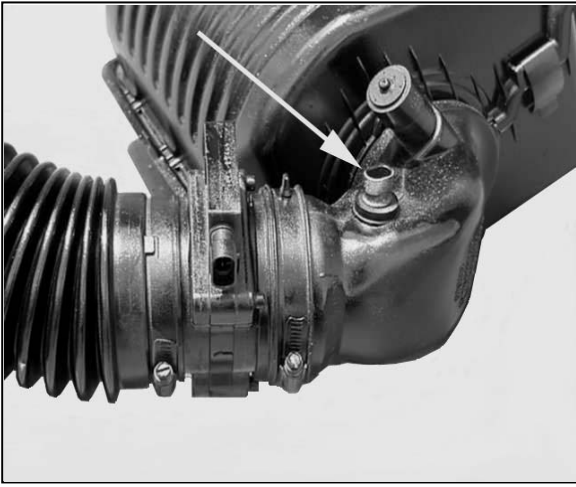

FIGURE 6.17 IAT Sensor

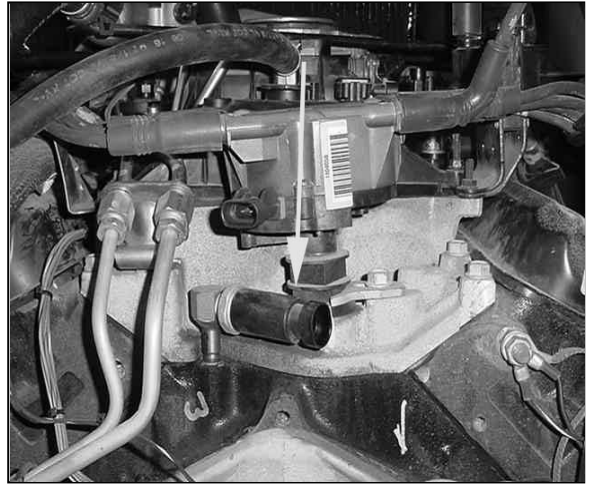

FIGURE 6.18 Fuel Pump/Oil PressureSwitch

6.4 TAIL SECTION INSTALLATION

6.4.1 Locate the tail section that you earlier separated from the engine group. Begin routing it towards the rear of the vehicle. Be sure to avoid all sharp edges, moving or hot parts, or anything else that may damage the harness.

6.4.2 If you are using the 4L80E transmission, route the 13-position connector to the transmission and attach it. Route the input shaft speed sensor connector to the transmission and attach it.

6.4.3 Take the connector for the Vehicle Speed Sensor (VSS) and connect to the Vehicle Speed Sensor.

6.4.4 Take the gray wire labeled FUEL PUMP and route it to the fuel pump. This is the power wire for the fuel pump.

6.4.5 Tail Section Connections

WIRE COLOR	# OF POSITIONS IN CONNECTOR	LABELED	CONNECT TO:
Red/Black, Blue/White	2	VSS Input	Vehicle Speed Sensor
Purple/White, Green/Black	2	VSS Output	Vehicle Speed Sensor
Lt. Green, Yellow/Black, Yellow, Red/Black, Lt. Blue/White, Pink, Pink/Black, Black, Red, Blue,, Tan/Black, Brown	13	Trans.	Transmission
Gray		Fuel Pump	Fuel Pump Power Terminal

TABLE 6.4 Tail Section Connections

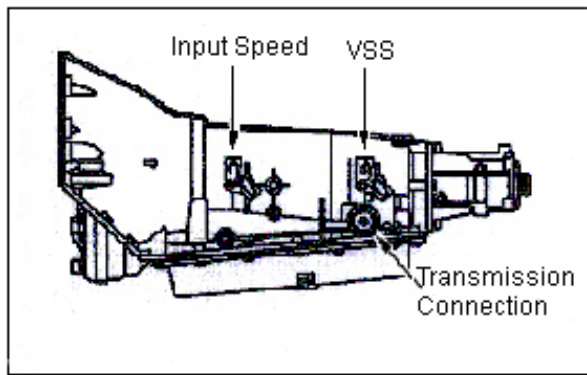

FIGURE 6.19 A/T Input Speed & VSS Sensor, Transmission Connection (4L80E)

7.0 TROUBLE- SHOOTING INSTRUCTIONS

If you are having trouble with your engine running badly or not running at all, first perform basic trouble-shooting (ensure that you are using the correct parts (Table 4.1), check for faulty connections, blown fuses, spark, timing, fuel pressure, etc.), then see if the computer has stored a trouble code in its memory.

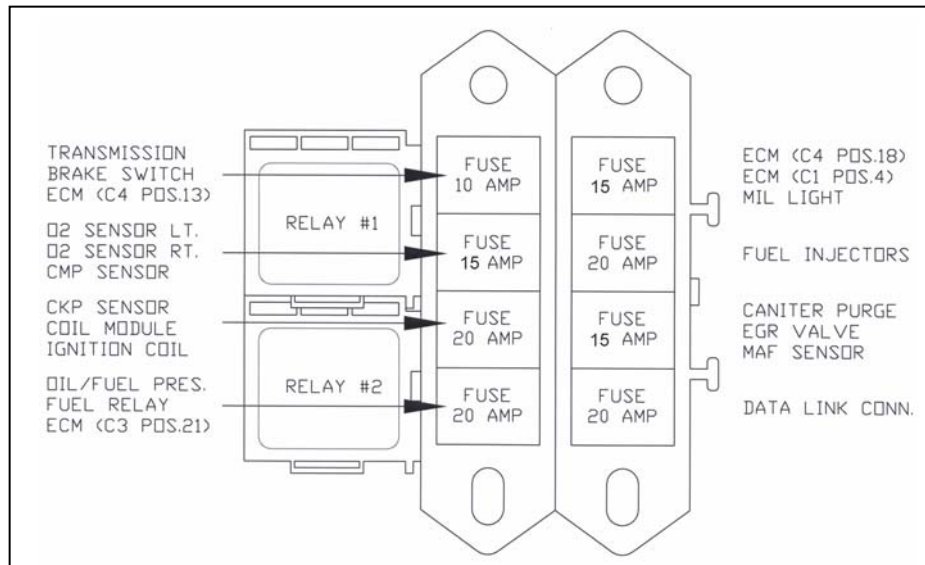

FIGURE 6.20 Fuse Identification

7.1 THE "CHECK ENGINE" LIGHT

Normally, the "check engine" light should come on when the ignition is turned on, then go out a few moments after the engine starts running. If it reappears, or stays on while the engine is running, the computer has detected a problem and a trouble code has been set.

NOTE: Most likely the check engine light will come on and stay on when using a computer with the original factory programming this is normal and is why we recommended that the computer be reprogrammed to remove any items that the factory vehicle had that aren't being used in the vehicle you are installing the engine into.

7.2 RETRIEVING TROUBLE CODES FROM THE COMPUTER

- 7.2.1 In order to retrieve the trouble codes stored in the computer, a scanner must be connected to the Assembly Diagnostic Link (DLC) connector (installed and connected in **Paragraph 6.2.1**). Follow the instructions provided with the scanner to read the codes set in the computer.
- 7.2.2 After you have read any codes, write them down for reference. Remove the connector from the DLC connector.
- 7.2.3 Take the codes one at a time and match them to the codes in the 1997 C/K Truck repair manual. This will tell you in which circuit the computer has detected a problem.

Note: A code indicates a problem in a specific circuit, **NOT THAT A PARTICULAR PART IS BAD.**

- 7.2.4 Before taking more extensive corrective actions for any trouble codes make sure that all connections on the indicated circuit, **INCLUDING THE COMPUTER**, are clean and tight. Inspect the wiring in the circuit for any broken, shorted, or exposed wires. Finally, insure all ground wires are clean and secure.
- 7.2.5 If a trouble code is detected and the problem has been fixed, clear the codes by first making sure the ignition is off then disconnecting the NEGATIVE battery cable for at least 3 minutes.

7.3 WHEN TO CALL PAINLESS PERFORMANCE PRODUCTS' TECH LINE

- 7.3.1 These harness kits have been built with the highest regard to quality control. Before calling us please double check all connections and perform normal basic trouble-shooting (fuel pressure, timing, ignition system, etc.).
- 7.3.2 If you have any questions concerning the installation of this harness or having trouble in general, feel free to call Painless Performance Products' tech line at 1-800-423-9696. Calls are answered from 8am to 5pm central time, Monday thru Friday, except holidays. Email questions to Tech@painlessperformance.com

We have attempted to provide you with the most accurate instructions possible, and are always concerned about corrections or improvements that can be made. If you have found any errors or omissions, or if you simply have comments or suggestions concerning these instructions, please write us at the address on the cover and let us know about them. Or, better yet, send us a fax at (817) 244-4024. We sincerely appreciate your business.

Painless Performance Limited Warranty and Return Policy

Chassis harnesses and fuel injection harnesses are covered under a lifetime warranty.

All other products manufactured and/or sold by Painless Performance are warranted to the original purchaser to be free from defects in material and workmanship under normal use. Painless Performance will repair or replace defective products without charge during the first 12 months from the purchase date. No products will be considered for warranty without a copy of the purchase receipt showing the sellers name, address and date of purchase. You must return the product to the dealer you purchased it from to initiate warranty procedures.