

Important Safety Instructions

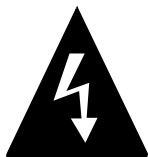

CAUTION

**RISK OF ELECTRIC SHOCK
DO NOT OPEN!**



CAUTION: TO REDUCE THE RISK OF ELECTRIC SHOCK, DO NOT REMOVE COVER (OR BACK). NO USE-SERVICEABLE PARTS INSIDE. REFER SERVICING TO QUALIFIED SERVICE PERSONNEL.



The lightning flash with arrowhead symbol, within an equilateral triangle, is intended to alert the user to the presence of uninsulated “dangerous voltage” within the product’s enclosure that may be of sufficient magnitude to constitute a risk of electric to persons.



The exclamation point within an equilateral triangle is intended to alert the user to the presence of important operating and maintenance (servicing) instructions in the literature accompanying the appliance.

WARNING: TO REDUCE THE RISK OF FIRE OR ELECTRIC SHOCK, DO NOT EXPOSE THIS APPLIANCE TO RAIN OF MOISTURE.

POWER SUPPLY:

Connect the supplied adapter to the side of the unit in the USB port. Plug the two-prong end of the power cord to an AC100-240V outlet. If you have difficulty inserting the plug, turn it over and reinsert it. If the unit will not be used for a long time, disconnect the plug from the outlet.

NOTE:

Before plugging the power cord into an AC outlet, make sure that all the connections have been made.

CAUTION: These servicing instructions are for use by qualified service personnel only. To reduce the risk of electric shock, do not perform any servicing other than that contained in the operating instructions unless you are qualified to do so. Refer to service manual for servicing instructions. To reduce the risk of fire or electric shock, do not expose this apparatus to rain or moisture.

Important Safety Instructions

NOTES

- 1) Read these instructions.
- 2) Keep these instructions.
- 3) Heed all warnings.
- 4) Follow all instructions.
- 5) Do not use this apparatus near water.
- 6) Clean only with a damp cloth.
- 7) Do not block any of the ventilation openings. Install in accordance with the manufacturer's instructions.
- 8) Do not install near any heat sources such as radiators, heat registers, stoves, or other apparatus (including amplifiers) that produce heat.
- 9) Do not defeat the safety purpose of the polarized or grounding-type plug. A polarized plug has two blades with one wider than the other. A grounding type plug has two blades and a third grounding prong. The wide blade or the third prong is provided for your safety. When the provided plug does not fit into your outlet, consult an electrician for replacement of the obsolete outlet.
- 10) Protect the power cord from being walked on or pinched particularly at plugs, convenience receptacles, and the point where they exit from the apparatus.
- 11) Only use attachments/accessories specified by the manufacturer.
- 12) Use only with a cart, stand, tripod, bracket, or table specified by the manufacturer, or sold with the apparatus. When a cart is used, use caution when moving the cart/apparatus combination to avoid injury from tip-over.
- 13) Unplug this apparatus during lightning storms or when unused for long periods of time.
- 14) Refer all servicing to qualified service personnel. Servicing is required when the apparatus has been damaged in any way, such as power-supply cord or plug is damaged, liquid has been spilled or objects have fallen into the apparatus, the apparatus has been exposed to rain or moisture, does not operate normally, or has been dropped.
- 15) Apparatus shall not be exposed to dripping or splashing and no objects filled with liquids, such as vases, shall be placed on the apparatus.



Important Safety Instructions

Warning

Failure to avoid the following potentially hazardous situations may result in injury or property damage.

The unit is designed to provide you with route suggestions. It does not reflect road closures or road conditions, traffic congestion, weather conditions, or other factors that may affect safety or timing while driving.

Use the unit only as a navigational aid. Do not attempt to use the unit for any purpose requiring precise measurement of direction, distance, location, or topography. This product should not be used to determine ground proximity for aircraft navigation.

CAUTION:

Danger of explosion if battery is incorrectly replaced. Replace only with the same or equivalent type.

The batteries (or batteries installed) shall not be exposed to excessive heat such as sunshine, fire or the like.

Underwriters Laboratories Inc. ("UL") has not tested the performance or reliability of the Global Positioning System ("GPS") hardware, operating software or other aspects of this product. UL has only tested for fire, shock or casualty hazards as outlined in UL's Standard(s) for Safety [Note-Consider referencing specific UL standard].

UL Certification does not cover the performance or reliability of the GPS hardware and GPS operating software.

UL MAKES NO REPRESENTATIONS, WARRANTIES OR CERTIFICATIONS WHATSOEVER REGARDING THE PERFORMANCE OR RELIABILITY OF ANY GPS RELATED FUNCTIONS OF THIS PRODUCT.

This device complies with part 15 of the FCC Rules. Operation is subject to the following two conditions:

- (1) This device may not cause harmful interference, and
- (2) This device must accept any interference received, including interference that may cause undesired operation.

Important Safety Instructions











Note: This equipment has been tested and found to comply with limits for Class B digital device, pursuant to part 15 of the FCC Rules. These limits are designed to provide reasonable protection against harmful interference in a residential installation. This equipment generates, uses and can radiate radio frequency energy and, if not installed and used in accordance with the instructions, may cause harmful interference to radio or television reception, which can be determined by turning the equipment off and on, the user is encouraged to try to correct the interference by one or more of the following measures:

1. Reorient or relocate the receiving antenna.
2. Increase the separation between the equipment and the receiver. Connect the equipment into an outlet on a circuit different from that to which the receiver is connected.
3. Consult the dealer or an experience radio/TV technician for help.

The images in this manual are only for reference and they may be different from the actual ones.

Accessories

Accessories List

ITEM	NAME	QTY
	Owner's Manual	2
	AC Adaptor	1
	Car Adaptor	1
	Mounting Bracket	1
	USB Cable	1
	Mounting cradle	1
	Touch Pen	1
	Dashboard mount disk	1
	SD Card	1
	Pouch	1

NOTE

Accessories and their part number are subject to modification without prior notice due to improvements.

Contents

Important Safety Instructions1
Accessories5
View of Main Unit7
System Connections8
Power Supply Preparation10
General Setup12
MP3 Player16
Photo Viewer18
Use of the Mount Accessories20
Troubleshooting21
Specifications23

View of Main Unit

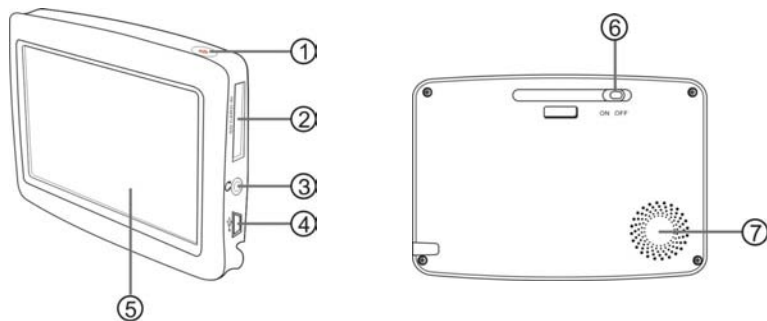

- 1. POWER Button**
Press for a longer time to enter or exit the standby mode.
- 2. Card Port**
Insert the SD card into the slot.
- 3. Earphone Jack**
Connect earphone for private listening. When the earphone is connected to this jack, the speaker will be turned off automatically.
- 4. USB Port**
Connect to the supplied adapter to charge the unit.
Used to connect to the USB device.
- 5. LCD Screen**
Finger touches the screen directly or use the touch pen included for optional.
- 6. ON/OFF Switch**
Used to switch power on or off.
- 7. Speakers**

System Connections

- Always ensure that the unit and any other external device connected to the unit are switched off and unplugged from the power supply before you attempt to connect the unit to any external device.

Connecting to PC

The unit is designed with a USB port which allows you to connect the unit to PC for map updating. See the below figure for details:

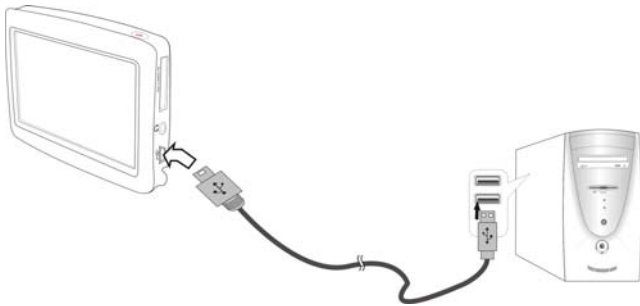

System requirements:

- Windows 98SE, ME, 2000 and XP
(Driver required for Windows 98SE)
- DVD Rom Drive (for map upgrade purposes)
- Intel Pentium II 233 Mhz
- 64 MB RAM
- 50 MB available hard drive space
- Available serial port and/or USB Port
- 256-color display adapter and monitor
(16 bit color required)

In the near future map updates will be available for down load from our website. Please check www.nextar.com periodically for the information on downloads.

System Connections

Inserting SD Card

The unit is designed with SD Card jack which allows you to insert the SD card into the unit as shown below:

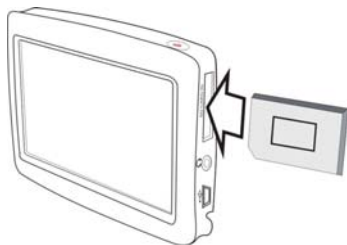

To remove the card, gently press the card in with your fingernail. The card unlocks and protrudes slightly. Then remove the card.

Connecting to Earphones

Connect the earphones to the right side of the unit for private listening.

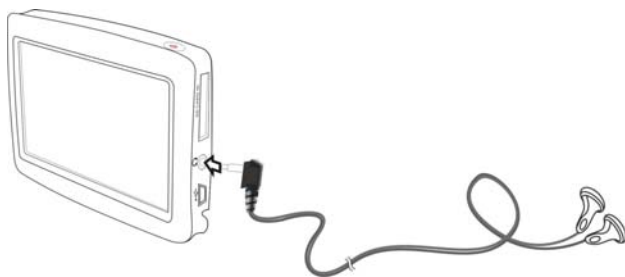

When earphone is connected, the speakers will automatically turn off.

Note: Excessively loud volume could damage your hearing. So turn down the volume before you connect the earphones, and then raise the volume to comfortable level.

Power Supply Preparation

Using the AC Adaptor

The unit is supplied with an AC adaptor for powering it and charging its battery.

1. Connect AC adaptor to the right side of the unit in the USB port, as shown on the right.
2. Plug the two-prong end of the power cord into a grounded electrical outlet.

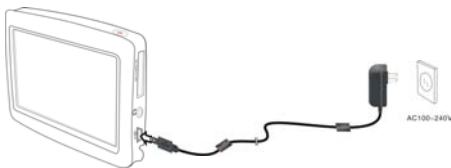

Note:

- Turn unit's power off before unplugging.
- In the case of using the adaptor, the LCD screen will be brighter than with the rechargeable battery.

Using of Car Adaptor

The unit is supplied with a Car Adaptor for powering it while in a vehicle.

Connect the Car Adaptor Power Plug to the unit's USB port and plug the other end to the vehicle's 5V accessory/ cigarette socket, as shown on the right figure.

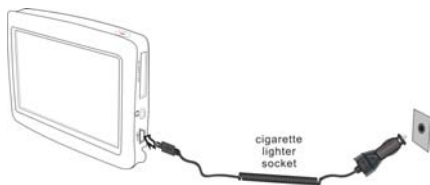

Attention

- Do not operate the unit while driving a vehicle.
- Place the unit in a proper position for viewing.
- Disconnect the unit from the Car Adaptor when starting the vehicle.

Your portable GPS unit comes with a built-in rechargeable battery. Please see details in the following segment.

About Rechargeable Battery

Your portable GPS device comes with a built-in rechargeable battery. Charge the battery fully before initial use. Charging time is normally about 3.5 hours. A fully charged battery delivers about 2.5 hours of use.

Working conditions and precautions for the rechargeable battery

- New batteries should be fully charged before initial use.
- Battery should only be used and charged when temperatures are between 32°-100°F.
- Maintain well-ventilated conditions around the product to avoid overheating. Don't put the product on a bed, sofa or anything that may block ventilation to the product.
- When the battery is weak, an indication menu will appear on the LCD screen and after a little while, the unit will power OFF automatically.

Charging the rechargeable battery

The battery must be charged by using the supplied adaptor.

General Setup

System Main Menu





When in navigation mode, Tap **MENU** button, and then choose **SETTINGS**.



In the **SETTINGS** menu, tap **EXIT**, a confirmation message appears. Tap **Exit** in the confirmation message to return to the system main menu, as shown below.



In the main menu, there are four items for selecting. Touch the corresponding item to enter.

Tap  to enter navigation mode; tap  to enter the MP3 player; tap  to enter the Photo Viewer; tap  to enter the settings menu.

Settings Menu

Tap  to enter the settings menu, the screen will display as below:







In the menu, tap  to return to the main menu.

General Setup

Language

Tap  in the settings menu to enter **Language** settings menu for language selecting, as shown below:



Tap the   buttons to select language. Then tap  to confirm or tap  to cancel.

Backlight

Tap  in the settings menu to enter **Backlight** settings menu for backlight adjusting, as shown below:



Tap the first group   buttons to adjust the backlight level.

Tap the second group  buttons to adjust the sleep time. There are 6 choices for sleep time (--/5/10/30/60/120).

--: The system will keep backlight always on and will not enter sleep mode.

5: The system will keep backlight on for 5 minutes and then enter sleep mode.

10: The system will keep backlight on for 10 minutes and then enter sleep mode.

30: The system will keep backlight on for 30 minutes and then enter sleep mode.

60: The system will keep backlight on for 1 hour and then enter sleep mode.

120: The system will keep backlight on for 2 hours and then enter sleep mode.







After setting, tap  to confirm or tap  to cancel.

General Setup

Date & Time

Tap  in the settings menu to enter **Date & Time** settings menu for changing to the current time zone, as shown below:



Tap the   buttons to select the proper Time Zone. Tap the   buttons of Date group to change the corresponding date and tap the   buttons of Time group to change the corresponding time. Tap  to return.

Power

Tap  in the settings menu to enter **Power** menu for the current battery status, as shown below:



The power menu will display the current battery status. Tap  to return.

General Setup

Screen

Tap  in the settings menu, the screen will display as below:







This item is used to calibrate the sensitivity of the touch screen. Tap the center of "+" as it moves around the screen. If you touch the center of "+" every time, it will disappear after having moved through a cycle (center→top left corner→bottom left corner→bottom right corner→top right corner). Tap the screen to return to the settings menu.

Note: If "+" doesn't disappear, you should calibrate again.

Volume

Tap  in the settings menu to enter **Volume** settings menu for volume adjusting, as shown below:



Tap the   buttons to adjust the volume. Then tap  to confirm or tap  to cancel.

Playing Music

The unit is designed with SD card slot. You can insert the SD card with MP3 and WMA files. It supports MP3, WMA format files playback.

Note: Do not store MP3 and WMA format files in the Flash storage, for the flash storage is used to store map data, any attempt to open the Flash storage may result in the map data missing and lost.

Warning: For your own safety, do not use the earphones when driving.

Take the following steps to play:

Loading MP3 and WMA format files

1. Insert the SD card with MP3 and WMA format files.
2. Turn on the unit.

Playing Music



In the main menu, tap  to enter the MP3 main screen, as shown below:

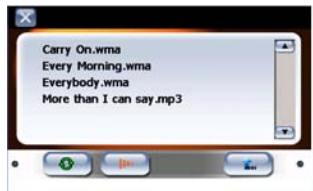

In the menu, tap the **MENU** button to enter the MP3 play list menu, as shown below:





Playing Music

When you open the play list, the system will look for audio files on its SD memory card and create a play list automatically. If the play list consists of more than one screen, tap the up arrow  for the previous page and the down arrow  for the next page.

In the play list, double tap the songs to start playback.

Tap ; when the button changes to orange, the player will repeat all the songs in the play list.

Tap ; when the button changes to orange, the player will play the songs in the list randomly.



Tap  or  in the top left corner of the play list menu to return to the MP3 main screen.

On the playback screen as shown below, the MP3 player has standard playback features:



Tap  button to start playing the songs in the play list.

Tap  to stop the playback.

Tap  to pause the playback, and then tap  to resume the playback.

Tap  to back to the previous song; tap  to skip to the next song.

Use VOL  to adjust the volume of the speaker.

Tap  to select the desired playback starting time.

In the MP3 player, tap  in the top left corner to exit.

Photo Viewer

The unit is designed with SD card slot. You can insert the SD card with JPEG files. It supports JPEG format files playback.

Note: Do not store JPEG format files in the Flash storage, for the flash storage is used to store map data, any attempt to open the Flash storage may result in the map data missing and lost.

It lags when reading high-resolution JPEG files in SD Card. We suggest low-resolution (within 640*480) pictures playback.

Playing JPEG Files

Insert SD card with JPEG files into the card slot of the unit, then tap  in the main menu to enter the photo viewer main screen, as shown below:





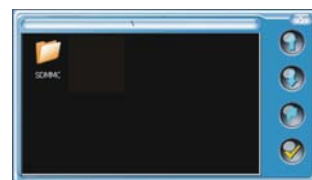

In the menu, tap  to enter the folder menu, as shown below:

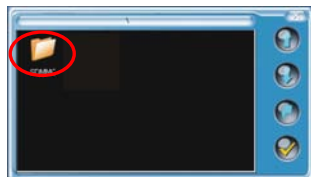

In the folder menu, double tap the memory card icon to open it, the pictures stored in the memory card will be listed on the screen.

Photo Viewer





If the pictures list consists of more than one screen, tap the up arrow  for the previous page and the down arrow  for the next page. Tap  to return to previous menu. Tap a picture to select it and tap  to confirm your selection.



In the pictures list, double tap a picture to play it on screen, as shown below.





On the playback screen, the Photo Viewer has following playback features:

Tap  to rotate the picture.

Tap  to back to previous picture; tap  to switch to next picture.

Tap ,  to zoom the picture in or out.

Tap  to play the picture in full-screen mode; double tap the screen again to return to the Viewer main screen.

Tap  to return to the pictures list.

Tap  in the top right corner of the menu to exit.

Use of the Mount Accessories

When using the unit in vehicle, you can use the supplied mount accessories (mount bracket, mount cradle and dashboard mount disk) to mount the unit in the vehicle. Take the following steps to operate:



Fig. 1



Fig. 2

1. See Fig. 1 to slide the mount cradle onto the end of the mount bracket.
2. See Fig. 2. Set the bottom edge of the unit onto the mount cradle. Then push the tap at the top of the mount cradle in arrow 1 direction to mount the unit to the mount cradle. To remove the unit, push the tap at the top of the mount cradle in arrow 1 opposite direction.
3. Lift the suction cup lever and then press the suction cup to the windshield. Then press down the suction cup lever in arrow 2 direction to fix the bracket to the windshield. At the end, rotate the knob to adjust the unit to proper position.

If you want to mount the unit to the dashboard, you can use the adhesive disk:

- 1) Choose a clean, dry spot on your dashboard.
- 2) Peel off protection liner from the back of the disk.
- 3) Attach the disk to your dashboard.
- 4) Mount the bracket to the adhesive disk.

Troubleshooting

Take steps described in the tables below to solve simple problems before contacting customer service.

If you suspect something wrong with this unit, immediately turn the power off and disconnect the power connector from the unit. Never try to repair the unit yourself because it is dangerous to do so.

PROBLEM	POSSIBLE CAUSE	POSSIBLE SOLUTION
Users can't turn on the unit.	The adaptor doesn't connect well.	Connect the adaptor correctly.
	The built-in rechargeable battery is weak.	Use the adaptor to supply power or charge the battery.
There is no sound.	The volume may be turned down or mute.	Turn up the volume or turn on the sound output.
Dim screen.	The brightness may be turned down.	Adjust the brightness of the LCD.
The unit can't receive satellite signals or can't orient.	The unit may be obstructed by buildings or metal block.	Make sure to use the unit out of room; if in the vehicle, you can use the external GPS antenna to solve this problem.

Troubleshooting

PROBLEM

The unit can receive signals now but can't then or signals received are not stable.

POSSIBLE CAUSE

POSSIBLE SOLUTION

The built-in rechargeable battery is weak.

Use the adaptor to supply power or charge the battery.

The unit may be obstructed by veil, such as heat insulation paper.

Remove the veil.

Swing of the unit is too great.

Avoid great swing of the unit.

System software of the unit fails to function by change.

Turn on the unit again.

Other possibilities:

Static or other external interference may cause the unit function abnormally. In order to recover normal status, please unplug the power supply cord and then plug it into the outlet again to reset the unit. If the problems still exist, please cut off the power supply and consult your service center or the qualified technician.

Specifications

TFT screen size	4.3 inches
Frequency Response	20Hz - 20kHz
Audio Signal-to-noise Rate	$\geq 65\text{dB}$
Audio distortion+noise	$\leq -20\text{dB}$ (1kHz)
Channel Separation	$\geq 70\text{dB}$ (1kHz)
Dynamic Range	$\geq 80\text{dB}$ (1kHz)
Power	AC 100-240V \sim 50/60Hz ; DC 5V
Power Consumption	$< 8\text{W}$
Dimensions	117mmX80mmX20mm (L*W*D)
Weight	About 0.17Kg

Design and specifications are subject to change without notice.

Nextar™, a trademark of Nextar (Hong Kong) Limited.