

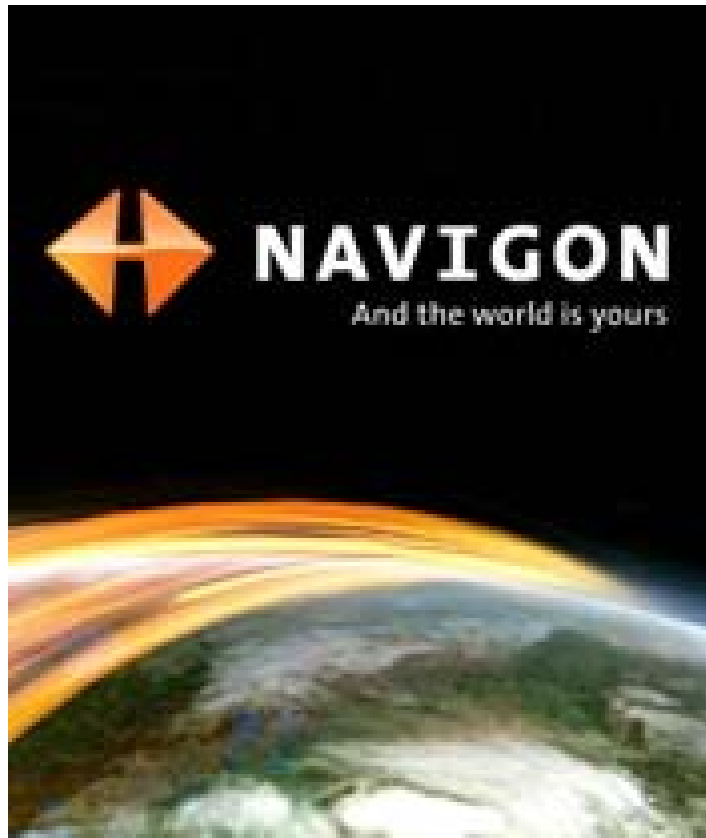

NAVIGON



NAVIGON 2000S / 2200T Series

User's Guide

English (US)

December 2008

For use with models:

NAVIGON 2000S

NAVIGON 2090S

NAVIGON 2200T

Version 1.1

Imprint

NAVIGON, INC
200 W Madison Street
Suite 650
Chicago, IL 60606

The information contained herein may be changed at any time without prior notification. This manual nor any parts thereof may not be reproduced for any purpose whatsoever without the express written consent of NAVIGON, INC, nor transmitted in any form either electronically or mechanically, including photocopying and recording. All technical specifications, drawings, etc., are subject to copyright law.

© 2008, NAVIGON, INC

All rights reserved.

End User License Agreement (EULA)

(SINGLE USE LICENSE)

PLEASE READ THE FOLLOWING SOFTWARE LICENSE (THE "LICENSE") BEFORE USING YOUR NAVIGON PRODUCT. BY USING YOUR NAVIGON PRODUCT, YOU ARE AGREEING TO BE BOUND BY THE TERMS OF THIS LICENSE. IF YOU DO NOT AGREE WITH THEM, OR DO NOT WANT THEM TO BE BINDING ON YOU, YOU SHOULD PROMPTLY RETURN THE NAVIGON PRODUCT TO THE PLACE WHERE YOU OBTAINED IT FOR A REFUND.

1. OWNERSHIP

It is hereby understood and agreed by you that NAVIGON, Inc. ("NAVIGON") is the owner of all title, ownership rights, intellectual property rights and copyrights in and to the software ("Software"), including, but not limited to, any source codes, object codes, codifications, methods, formulas, images, photographs, animation, video, audio and text incorporated into the Software and the accompanying printed materials. The Software shall remain the sole and exclusive property of NAVIGON and its licensors' and NAVIGON and its licensors' will retain all patents, copyrights and other intellectual property rights in the Software, as applicable. For the avoidance of doubt, you also hereby understand and agree that NAVIGON and/or its third party licensors own all right, title and interest in and to all accessories and content which work with, are included in or subsequently enabled on the Software, including, but not limited to, all intellectual property rights therein (the "Content").

You through your purchase of this product do not acquire any ownership rights to the Software or Content. You own the hardware device (the "Hardware Device") on which the Software is recorded, but NAVIGON or its licensors', as applicable, retain ownership of all copies of the Software and Content at all times.

2. LICENSE

2.1 In consideration of the payment of a license fee, which is a percentage of the price paid by you for this Software and Hardware Device, NAVIGON hereby grants you a limited and non-exclusive right to use and display this copy of the Software and Content on this single Hardware Device. This License does not grant any rights to obtaining future upgrades, updates or supplements of the Software or Content. If upgrades, updates or supplements of the Software are obtained, however, the use of such upgrades or updates is governed by this License and the amendments that may accompany them and may be subject to additional payments and conditions.

2.2 NAVIGON hereby reserves any and all rights to and may require that Software and Content upgrades (including, but not limited to, version changes) be downloaded into your Hardware Device to receive applicable updates. These software upgrades may potentially change your user experience.

2.3 All rights not expressly granted are hereby reserved by NAVIGON.

3. TERM

The License is effective until terminated. Your rights under this License will terminate automatically without notice from NAVIGON if you fail to comply with any term(s) of this License. Upon the termination of this License, you shall cease all use of the Software.

4. RESTRICTIONS ON USE

4.1 You shall not transfer the Software to other suitable hardware devices without NAVIGON's express, prior written consent.

4.2 You shall not, without NAVIGON's express written consent:

- (a) Copy or reproduce the Software;
- (b) Electronically transfer the Software through area or other network systems or any other system or use the Software on a server or any other device that permits simultaneous use of the Software by multiple users;
- (c) Reproduce, copy, modify, adapt, reverse engineer, decompile or create derivative works based on the Software or any accompanying materials; or
- (d) Remove, destroy, cover-up or obliterate any notices on the Software with regard to patent, trademark, trade dress or any other intellectual property or proprietary right.

4.3 You may not transfer the Content included within the Software apart from a permitted transfer of the Software itself. You also may not extract or remove the Content from the Software or otherwise make use of the Content apart from the Software.

4.4 You agree to use the Content with the Hardware Device solely for personal, non-commercial purposes for which you were licensed, and not for service bureau, time-sharing or other similar purposes. Accordingly, but subject to the restrictions set forth in Sections 4 and 5, you may copy the Content only as necessary for your personal use to (a) view it, and (b) save it, provided that you do not remove any copyright notices that appear and do not modify the Content in any way. You agree not to otherwise reproduce, copy, modify, adapt, decompile, disassemble or reverse engineer any portion of the Content, and may not transfer or distribute it in any form, for any purpose, except to the extent permitted by mandatory laws.

4.5 THE SOFTWARE, CONTENT AND THE HARDWARE DEVICE ARE NOT DESIGNED OR INTENDED FOR USE IN ON-LINE CONTROL OF AIRCRAFT, AIR TRAFFIC, AIRCRAFT NAVIGATION OR AIRCRAFT COMMUNICATIONS, OR IN THE DESIGN, CONSTRUCTION, OPERATION OR MAINTENANCE OF ANY NUCLEAR FACILITY OR FOR USE IN THE CONTROL OF MASS TRANSIT OR MEDICAL APPLICATIONS OR IN ANY OTHER INHERENTLY DANGEROUS APPLICATION. NAVIGON AND ITS SUPPLIERS DISCLAIM ANY EXPRESS OR IMPLIED WARRANTY OF FITNESS FOR SUCH USES AND SHALL NOT BE LIABLE FOR ANY

CLAIMS OR DAMAGES ARISING FROM SUCH USE IF YOU USE THE SOFTWARE, CONTENT OR HARDWARE DEVICE IN SUCH APPLICATIONS.

5. RESTRICTIONS ON TRANSFER

5.1 You may transfer, in whole, the Hardware Device, the Software and this License to another party if the other party agrees to accept the terms and conditions of this License. For the avoidance of doubt, you may not transfer the Software and related Content separately from the Hardware Device.

5.2 You shall not sub-license, lease, assign, or transfer the Hardware Device, the Software and this License except as expressly provided in this License. Any attempt otherwise to sub-license, lease, assign, or transfer any of the rights, duties, or obligations hereunder renders this License VOID.

6. EXPORT CONTROL

You may not use or otherwise export or re-export the Software except as authorized by the laws of the United States law and the laws of the jurisdiction(s) in which the Software were obtained. For the avoidance of doubt, the Software may not be exported or re-exported (a) into any U.S. embargoed countries or (b) to anyone on the U.S. Treasury Department's list of Specially Designated Nationals or the U.S. Department of Commerce Denied Person's List or Entity List. By using the Software, you represent and warrant that you are not located in any such country or on any such list. You also agree that you will not use the Software for any purposes prohibited by laws of the United States, including, without limitation, the development, design, manufacture or production of missiles, nuclear, chemical or biological weapons.

7. WARRANTY DISCLAIMER

7.1 EXCEPT FOR THE LIMITED WARRANTY DOCUMENT INCLUDED WITH THE HARDWARE DEVICE, IF ANY, AND TO THE MAXIMUM EXTENT PERMITTED BY APPLICABLE LAW, ALL SOFTWARE, OTHER COMPONENTS THEREOF AND CONTENT ARE PROVIDED ON AN "AS IS" BASIS. YOU EXPRESSLY ACKNOWLEDGE AND AGREE THAT YOUR USE OF THE SOFTWARE IS AT YOUR SOLE RISK AND THAT THE ENTIRE RISK AS TO SATISFACTORY QUALITY, PERFORMANCE, ACCURACY AND EFFORT IS WITH YOU. EXCEPT AS OTHERWISE EXPRESSLY STATED IN THIS LICENSE, NAVIGON DOES NOT MAKE, AND HEREBY EXPRESSLY DISCLAIMS, ANY AND ALL EXPRESS AND/OR IMPLIED WARRANTIES, INCLUDING, BUT NOT LIMITED TO, WARRANTIES OF MERCHANTABILITY, FITNESS FOR A PARTICULAR PURPOSE, NONINFRINGEMENT AND TITLE, AND ANY WARRANTIES ARISING FROM A COURSE OF DEALING, USAGE OR TRADE PRACTICE. WITHOUT LIMITING THE FOREGOING, (A) NAVIGON DOES NOT WARRANT THAT (i) THE SOFTWARE OR CONTENT WILL MEET YOUR REQUIREMENTS, (ii) THE SOFTWARE OR CONTENT WILL BE UNINTERRUPTED, TIMELY, SECURE OR ERROR-FREE, (iii) THE RESULTS THAT MAY BE OBTAINED FROM THE USE OF THE SOFTWARE OR CONTENT WILL BE ACCURATE OR RELIABLE, OR (iv) ANY ERRORS IN THE SOFTWARE OR CONTENT WILL BE CORRECTED; AND (B) NO ADVICE OR INFORMATION, WHETHER ORAL OR WRITTEN, OBTAINED BY

YOU FROM NAVIGON OR THROUGH THE USE OF THE SOFTWARE OR CONTENT SHALL CREATE ANY WARRANTY NOT EXPRESSLY STATED IN THIS LICENSE. YOU UNDERSTAND AND AGREE THAT THE USE OF THE SOFTWARE AND CONTENT IS DONE AT YOUR OWN DISCRETION AND RISK AND THAT YOU WILL BE SOLELY RESPONSIBLE FOR ANY DAMAGES. SOME JURISDICTIONS DO NOT ALLOW THE EXCLUSION OF IMPLIED WARRANTIES OR LIMITATIONS ON APPLICABLE STATUTORY RIGHTS OF A CONSUMER, SO THE ABOVE EXCLUSION AND LIMITATIONS MAY NOT APPLY TO YOU.

7.2 This exclusion does not apply to (a) any implied condition as to title and (b) any implied warranty as to conformity with description. If applicable law requires any implied warranties with respect to the Software, Content or the Hardware Device, all such warranties are limited in duration to ninety (90) days unless stated otherwise in writing.

7.3 Any suggestions by NAVIGON or NAVIGON's agents regarding use, application, or suitability of the Software shall not be construed as an express warranty unless confirmed to be such in writing by NAVIGON.

8. LIMITATION OF LIABILITY

8.1 TO THE MAXIMUM EXTENT PERMITTED BY LAW AND EXCEPT AS OTHERWISE EXPRESSLY STATED IN THIS LICENSE, NAVIGON WILL NOT BE LIABLE OR RESPONSIBLE TO YOU OR ANY OTHER PERSON OR ENTITY FOR ANY TYPE OF DIRECT, INCIDENTAL, SPECIAL, PUNITIVE, INDIRECT OR CONSEQUENTIAL DAMAGES, INCLUDING, BUT NOT LIMITED TO, LOST REVENUE, LOST PROFITS, REPLACEMENT GOODS, LOSS OF PROPRIETARY MATERIAL, RIGHTS OR SERVICES, BUSINESS INTERRUPTION, LOSS OR CORRUPTION OF ELECTRONIC COMMUNICATIONS, OR INTERRUPTION OR LOSS OF USE OF SERVICES OR EQUIPMENT, EVEN IF ADVISED OF THE POSSIBILITY OF SUCH DAMAGES, OTHER PECUNIARY LOSS, AND WHETHER ARISING UNDER THEORY OF CONTRACT, TORT (INCLUDING NEGLIGENCE), STRICT LIABILITY OR OTHERWISE. SOME JURISDICTIONS DO NOT ALLOW THE LIMITATION OF LIABILITY FOR PERSONAL INJURY, OR OF INCIDENTAL OR CONSEQUENTIAL DAMAGES, SO THIS LIMITATION MAY NOT APPLY TO YOU.

8.2 IN NO EVENT SHALL NAVIGON'S TOTAL LIABILITY (WHETHER ARISING UNDER A THEORY OF CONTRACT, TORT, INCLUDING NEGLIGENCE, STRICT LIABILITY OR OTHERWISE) UNDER OR IN CONNECTION WITH THIS LICENSE OR BASED ON ANY CLAIM FOR INDEMNITY OR CONTRIBUTION EXCEED THE AMOUNT OF PURCHASE PRICE OF THE LICENSE. NOTWITHSTANDING ANY OF THE FOREGOING, YOU EXPRESSLY ACKNOWLEDGE AND AGREE THAT NAVIGON WILL NOT BE LIABLE FOR ANY CLAIMS OR DAMAGES WHATSOEVER, WHICH ARISE MORE THAN ONE (1) YEAR PRIOR TO THE INSTITUTION OF A LAWSUIT. THE FOREGOING LIMITATIONS WILL APPLY EVEN IF THE ABOVE STATED REMEDY FAILS OF ITS ESSENTIAL PURPOSE.

8.3 Without limiting the foregoing, NAVIGON shall not be liable for any loss resulting from a cause over which NAVIGON does not have sole and direct control, including, but not limited to, failure of electronic or mechanical equipment or communication lines; telephone or other interconnection problems; bugs, errors, configuration problems or incompatibility of computer hardware or

software; problems with equipment or services relating to your computers; problems with intermediate computer or communications networks or facilities; problems with data transmission facilities or your telephone or telephone services; unauthorized access, theft, operator errors, severe weather, earthquakes or labor disputes; or the termination of traffic data services or networks by service providers of same.

9. THIRD PARTY SOFTWARE LICENSES

NAVIGON and the Hardware Device may make use of third party software. Notwithstanding the terms and conditions of this License, use of some third party materials included in the Software may be subject to other terms and conditions. The official third party copyright notices and specific license conditions of these third party software codes and algorithms are provided at the end of this License. You hereby agree to the terms and conditions for such third party software.

10. REMEDIES FOR BREACH

You understand and agree that NAVIGON will not have adequate remedy at law for the material breach or threatened breach by you, or your, agents, employees, representatives or subcontractors, of any one or more of the covenants set forth in this License, including, but not limited to, Sections 3, 4, 5 and 6 of this License. You agree that in the event of any such material breach or threatened breach, NAVIGON may, in addition to (but not in substitution for) the other remedies which may be available to it either at law or in equity, file suit in equity to enjoin you from the breach of or threatened breach of said covenants.

11. JURISDICTION AND DISPUTES; SEVERABILITY

11.1 This License is governed by the laws of the State of Illinois without regard to its conflict of laws rules.

11.2 All disputes hereunder shall be resolved in the applicable state or federal courts of the State of Illinois located within Cook County, Illinois. To the extent permitted by law the parties consent to the jurisdiction of such courts, agree to accept service of process by mail, and waive any jurisdictional or venue defenses otherwise available.

11.3 If at any time any one or more of the provisions of this License become invalid, illegal or unenforceable in any respect for any reason, the validity, legality and enforceability of any such provision in every other respect and of the remaining provisions of this License shall not be in any way impaired.

12. INTEGRATION

This License constitutes the entire understanding of the parties, and revokes and supersedes all prior agreements, oral or written, between the parties, and is intended as a final expression of their agreement. This License shall not be modified or amended except in writing signed by

NAVIGON. This License shall take precedence over any other documents that may be in conflict therewith.

ADDITIONAL TERMS AND CONDITIONS OF USE RELATING TO THE TOTAL TRAFFIC NETWORK DATA PROVIDED WITH YOUR NAVIGON PRODUCT:

A. Total Traffic Network, a division of Clear Channel Broadcasting, Inc., holds the rights to the traffic incident data and RDS-TMC network through which it is delivered. You may not modify, copy, scan or use any other method to reproduce, duplicate, republish, transmit or distribute in any way any portion of traffic incident data. You agree to indemnify, defend and hold harmless Clear Channel Broadcasting, Inc. (and its affiliates) against any and all claims, damages, costs or other expenses that arise directly or indirectly out of (1) your unauthorized use of the traffic incident data or the RDS-TMC network, (2) your violation of this directive and/or (3) any unauthorized or unlawful activities by you in connection herewith.

B. Total Traffic Network traffic data is informational only. User assumes all risk of use. Total Traffic makes no representations about content, traffic and road conditions, route usability, or speed.

C. TOTAL TRAFFIC NETWORK TRAFFIC DATA IS PROVIDED "AS IS," AND "WHERE IS". TOTAL TRAFFIC NETWORK EXPRESSLY DISCLAIMS ALL WARRANTIES OR WITH RESPECT TO THE TRAFFIC DATA (INCLUDING, WITHOUT LIMITATION, THAT THE TRAFFIC DATA WILL BE ERROR-FREE OR WILL OPERATE WITHOUT INTERRUPTION), EXPRESS, IMPLIED OR STATUTORY, INCLUDING, WITHOUT LIMITATION, THE IMPLIED WARRANTIES OF MERCHANTABILITY, NON-INFRINGEMENT, FITNESS FOR A PARTICULAR PURPOSE, OR THOSE ARISING FROM A COURSE OF DEALING OR USAGE OF TRADE.

D. TOTAL TRAFFIC NETWORK WILL NOT BE LIABLE TO YOU FOR ANY INDIRECT, SPECIAL, CONSEQUENTIAL, EXEMPLARY, OR INCIDENTAL DAMAGES (INCLUDING, WITHOUT LIMITATION, LOST REVENUES, ANTICIPATED REVENUES, OR PROFITS RELATING TO THE SAME) ARISING FROM ANY CLAIM RELATING DIRECTLY OR INDIRECTLY TO USE OF THE TRAFFIC DATA, WHETHER A CLAIM FOR SUCH DAMAGES IS BASED ON WARRANTY, CONTRACT, TORT (INCLUDING, WITHOUT LIMITATION, NEGLIGENCE OR STRICT LIABILITY).

E. IN SOME AREAS A PORTION OF THE TRAFFIC INFORMATION IS PROVIDED BY INRIX, INC. AND (IN CERTAIN STATES) VIRGINIA DEPARTMENT OF TRANSPORTATION, UDOT COMMUTERLINK™, AND/OR LOS ANGELES METRO AND CALTRANS. ALL RIGHTS RESERVED.

NOTICE REGARDING NAVIGON FRESHMAPS FEATURE:

Internet access is required to use the FreshMaps feature on your NAVIGON enabled product. Download performance can vary based on bandwidth speeds. When applicable, your NAVIGON FreshMaps subscription includes quarterly map updates. For NAVIGON FreshMaps accessory activation is purchased, you must register your product at www.navigonusa.com/freshmaps within 60 days from the date of purchase of the accessory to qualify for updates. NAVIGON hereby reserves any and all rights to and may require that software upgrades (including, but not limited to, version changes) be downloaded into your device to receive NAVIGON FreshMaps updates. These software upgrades may potentially change your user experience. Retain proof of purchase to assist with future customer support.

This page intentionally left blank.

Contents

End User License Agreement (EULA)	iii
---	-----

Introduction

About this User Guide.....	1
Conventions	1
Symbols	1
Legal notice	2
Liability	2
Trademarks	2
Customer Service	3
Telephone Support.....	3
E-mail	3
The NAVIGON Shop.....	4

Welcome

Introducing Your NAVIGON Device.....	5
About GPS navigation.....	6

Getting Started

What's included	7
Important safety information	8
Navigation safety information.....	8
Safety information for the navigation device	9
Safety guidelines for Installation	9
Preparing your Device for use	10
Charging the battery.....	10
Power Interruptions	10
Installing the Car Cradle	11
Assembling the Cradle	11
Securing the Cradle	11
Placing the Navigation Device in the Cradle	12
Powering the navigation device	12
Optional Accessory Services	13
Activate Accessory Services.....	13
Activating ZAGAT POI Accessory	13
Activating NAVIGON FreshMaps Accessory Service.....	15

Basic Operations

Starting the Device	17
Turning the Device Off	18
First Time Startup.....	18
Using the Screensaver.....	19
Selecting Day/Night Viewing Mode	19
Viewing Version Information	20
Using Standby Mode	21
From the Main Window.....	21
From Any Device Window	21
Switching the Device Back On From Standby.....	21
The Main Window	22
New Destination	22
My Destinations	22
Take Me Home	22
Show Map.....	22
The Standby Button.....	22
The Options Button.....	23
Initializing the GPS receiver	24
Setting the volume	24
Viewing device status	25
GPS.....	25
Power	25
Traffic Information (TMC) (NAVIGON 2200T only)	26
Using Keyboards	27
Alphabetic keyboard	27
Numeric keyboard	27
Special character/symbol keyboard	27
Special keys	28
Using menus.....	28

DirectHelp

The DirectHelp Window	29
Using DirectHelp.....	32

Destination Selection

Using auto-complete to select a destination	33
The Search Area Tab	34
Search Areas	34
Selecting a Search Area Using the Keyboard	34
Selecting a Search Area From a List	35
Ways to Search for Destinations	36
Enter an Address	36
Search for a POI	36
Select a Direct Access POI	36
Tap on the Map	36
Entering an address	37
Selecting a Point of Interest (POI) destination	40
POIs nearby	40
POIs in a specified city	42
Statewide POIs	45
Selecting a Direct Access POI	47
Specify Direct Access POI categories	48
Information about the POI	49
Searching for POIs Near a Selected Location	50
Selecting a destination by tapping the map	53
Starting navigation	55
Quitting navigation	55
No GPS reception	55
Arriving at your destination	55

ZAGAT POIs (Optional Accessory)

ZAGAT POI Categories	57
Zagat Ratings	57
Rating Ranges	57
Price Ranges	58
Rating Basis	58
Search for ZAGAT POIs	58
View ZAGAT POI Information	59

My Destinations

Saving a destination to the Favorites List	61
Saving the current location using GPS	62
Saving your home address as a Favorite Destination.....	62
Navigating Home	64
Selecting a saved destination	65
Selecting a destination from the Favorites list.....	65
Selecting a destination from the Last Destinations list.....	66

Routes

Accessing the Route Planning Window	67
Entering the starting point	67
Changing the starting point	68
Entering route points	68
Changing the order of route points.....	69
Managing routes	70
Saving routes	70
Loading routes	70
Navigation.....	71
Calculating and displaying routes	71
Viewing or Changing the Route Profile	71
Simulating routes	72
Starting a route simulation	72
Ending simulation.....	72
Viewing a Turn-by-Turn List.....	73
Blocking route sections	73
Removing blocks and using original routes.....	74

Maps

Forty-Eight Contiguous United States Map	75
North America Map.....	76
View information on the current map	76
Map Preview mode	77
Map Navigation mode.....	79
Map functions in Navigation mode	81
Destination Search mode	82
Operating in Destination Search mode	83
Reality View Pro	84

Turning on Reality View Pro.....	84
NAVIGON Lifetime Traffic (NAVIGON 2200T only)	
Accessing the NAVIGON Lifetime Traffic Window.....	85
The NAVIGON Lifetime Traffic Window.....	86
Types of Messages.....	86
Specify the type of traffic messages to display.....	86
Traffic Flow Severity Indicators.....	87
Event or Incident Icons.....	88
Displaying traffic messages.....	89
Select Reroute Settings.....	90
Reroutes.....	91
Requesting a route recalculation.....	91
Canceling a Reroute Calculation for a Traffic Event.....	92
TMC Status Window.....	93
Select another station.....	93
Select Tuning Mode Settings.....	93
Recalculating Route.....	93
Customization	
Accessing the Settings window.....	95
The Settings Window.....	95
Navigation Settings.....	95
Route Profile Settings.....	96
Map Display Settings.....	96
General Settings.....	97
Options Button.....	98
Selecting options.....	99
Moving between pages.....	99
Viewing a list of options for a setting.....	99
Viewing information about a setting.....	99
Toggling between options.....	99
Changing an option setting.....	100

Legal Notices

NOTICE TO DRIVERS IN CALIFORNIA AND MINNESOTA	101
GPS.....	101

Technical Data

Specifications.....	103
Compliance Notices.....	105
Federal Communication Commission Interference Statement.....	105
Canada C Request.....	105

Index

Introduction

About this User Guide

Conventions

For better legibility and clarification, the following styles are used in this manual:

Italics: Registered names, company and product descriptions.

SMALL CAPITALS: WINDOW, LIST, AND DIALOG BOX TITLES.

Bold Italics: View modes.

Bold: Descriptions of buttons, tabs, input fields and other elements on the screen.

Symbols

The following symbols refer to specific passages of text:



Warnings.



Instructions and tips for operating the software.



More detailed information and explanations.

Legal notice

Liability

The software and the manual are subject to change without notice. NAVIGON, INC is not liable for the accuracy of the information contained in this manual or for damages resulting from the use of this manual.

Trademarks

All brands and trademarks mentioned in this document are possibly registered by third parties and are subject to the current legislation and to the rights of their respective owners without reservation. All mentioned names of products, societies, or brands may be registered trademarks of their respective owners. Every right that is not explicitly accorded is reserved.

The absence of the explicit labeling of registered trademarks used in this manual does not imply that the brand is not subject to the rights of a third party.

NAVIGON, DirectHelp, and Reality View Pro are trademarks of NAVIGON, INC.

DirectHelp and NAVIGON Lifetime Traffic are service marks of NAVIGON, INC.

Microsoft, Windows, and Excel are trademarks of the Microsoft Corporation.

NAVTEQ is a registered trademark of NAVTEQ.

ZAGAT SURVEY Ratings and Reviews is a registered trademark of ZAGAT Survey, LLC.

Total Traffic Network is a registered trademark of Total Traffic Network.

Clear Channel is a registered trademark of Clear Channel Communications.

ZENRIN is a registered trademark of ZENRIN EUROPE GmbH.

Customer Service

Visit the NAVIGON website (www.navigonusa.com/support/) to view our support page. On this page you can:

- Register your device.
- Search the NAVIGON database for frequently asked questions.
- Download navigation software updates.
- Send an e-mail to the NAVIGON support team.
- Call Customer Service.
- View or download User Guides.
- Report a problem.
- Report a map inaccuracy.



Telephone Support

Telephone: (888) 848-0701 (Toll Free)

Service Hours: Monday through Friday, 7 a.m. to 9 p.m. CT
(except official holidays)

E-mail

To ensure a timely response use e-mail at www.navigonusa.com/support/ and select **By Email**. Customers will receive a response within 2 business days.

The NAVIGON Shop

If you need accessories or accessory services for your device, please visit the NAVIGON web store at www.navigonusa.com/store/.

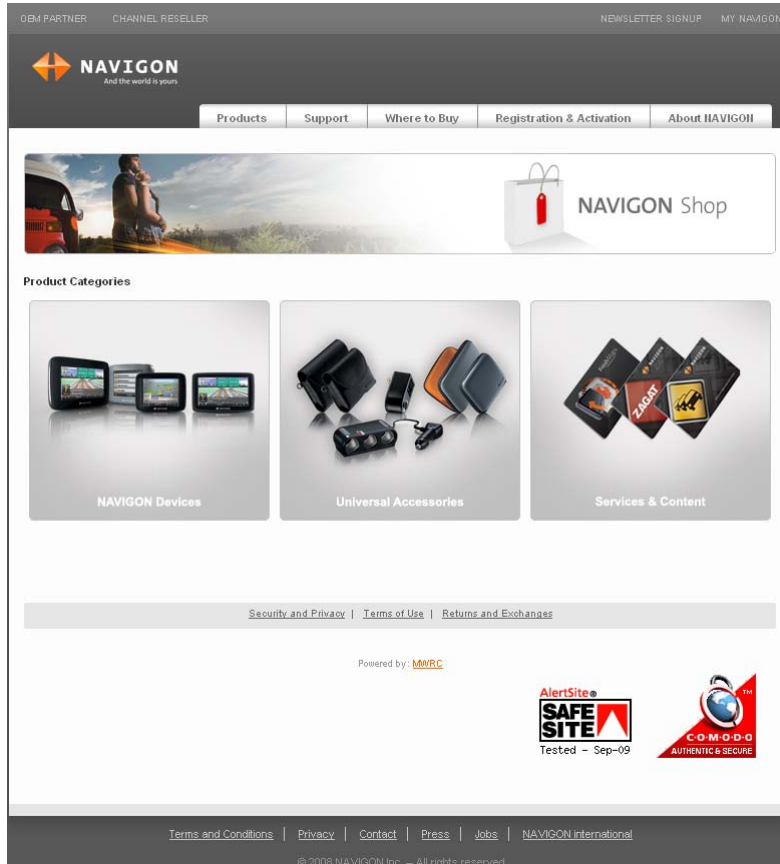

Welcome

Introducing Your **NAVIGON** Device



Welcome to the exciting world of handheld navigation. The **NAVIGON** device offers Global Positioning System (GPS)-based navigation and millions of Points Of Interest (POIs).

With NAVIGON Lifetime Traffic accessory service (**NAVIGON 2200T only**), your navigation system can receive the latest traffic information available. If necessary, it can change your route dynamically in order to avoid traffic congestion.

With the optional ZAGAT Survey Ratings and Reviews POI accessory, you receive ratings on thousands of POIs from the world's leading provider of consumer survey-based dining, travel and leisure information.

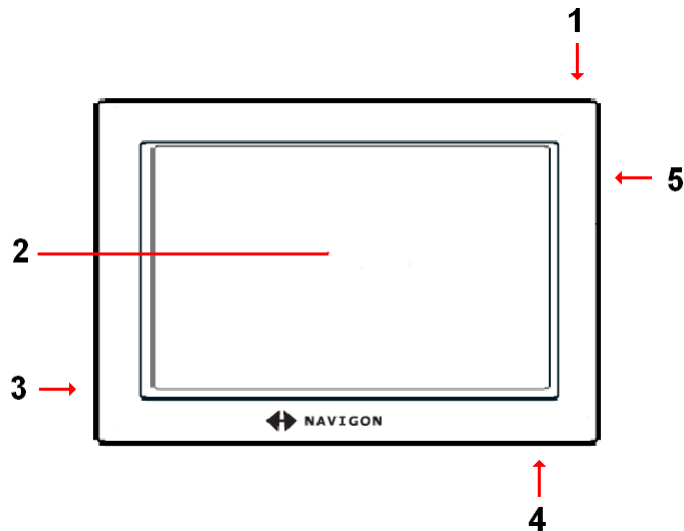
With NAVIGON FreshMaps, you can receive quarterly map updates.



1		On/Standby/Off
2		Touch screen
3		MicroSD card slot
4		Power Connector Port (with integrated TMC antenna NAVIGON 2200T only)
5	RESET	Reset

About GPS navigation

The Global Positioning System (GPS) uses a constellation of up to 32 satellites that enable a GPS receiver to calculate its geographical position.

For a sufficiently precise positioning it is necessary to obtain the data from at least three satellites. With the data from 4 or more satellites the altitude above sea level can also be determined.

Geographical terrain (such as mountains), man-made structures (such as highway overpasses, bridges and tall buildings), and even weather can interfere with or disrupt the GPS signal.

Once the navigation device has determined your position, it can be used as a starting point for route calculation.

The map data on your navigation device includes the geographical coordinates of all digitally recorded Points Of Interest (POIs), streets and places. This enables the device to calculate a route between a starting point and a destination.

The calculation of the current position and its representation on the map takes place once every second so your current position is always shown on the map.

If GPS reception is impaired, navigation is interrupted but the navigation software remains active. As soon as GPS reception is restored, the navigation system calculates any change of position which has occurred in the meantime and navigation may simply be continued.



Caution! The United States government operates the Global Positioning System (GPS) and is solely responsible for its accuracy and maintenance. Changes by the United States government may affect the accuracy and performance of all GPS equipment, including your personal navigation device.

Caution! Ordinances or laws may restrict use of certain abilities of your navigation device on public or private land.

Getting Started

What's included

Your **NAVIGON** device comes with the following accessories. If the contents are incomplete, please notify us **within 14 days of purchase**. The purchased product includes:

- **NAVIGON** navigation device
- Car cradle, device holder, and mounting disk
- Car charger cable (12 volt adapter) with integrated TMC antenna(**NAVIGON 2200T** only).
- Quick Start Guide
- Warranty and Safety Flyer

Important safety information



Caution! Please be sure to read, understand, and follow the safety information in “Important safety information” on page 8.

Navigation safety information

Use this navigation system at your own risk.



Caution! To prevent accidents, do not operate the navigation system while driving.

Caution! Do not look at the display unless it is absolutely safe to do so!

Caution! Traffic regulations have priority over any instructions from the navigation system.

Caution! Follow the instructions of the navigation system only when the circumstances and the road traffic regulations allow you to do so! The navigation system guides you to your destination even if you deviate from the calculated route.

Caution! Check that the cradle is secured and adjusted properly before each journey.



Note: If you have not understood the spoken instructions, or you're not sure about what to do next, you can briefly refer to the map or arrow view of your navigation system.

Safety information for the navigation device



Caution! Do not use pointed or sharp-edged objects on your device's touch screen. Your **NAVIGON** device is designed for use by simply tapping the touchscreen with your finger.

Caution! Protect the device from moisture. The device is not waterproof and is not protected against water damage.

Caution! Do not run cables directly next to safety-relevant devices and supply lines.

Caution! After installation, check all safety-relevant equipment in the car.

Caution! Unplug the navigation device's power supply when you park the vehicle. The navigation device requires power in standby mode, and may drain the vehicle's battery. When not using your device for an extended of time see "Turning the Device Off" on page 18.

Caution! Do not open the navigation device's casing under any circumstances.

Caution! Do not attempt to replace the battery. For problems related to the battery, contact NAVIGON Customer Support.

Caution! Always follow local regulations when disposing of this device.

Caution! Do not expose the navigation device to extreme heat or cold. This may damage the device or impair its function.

Caution! Use only the charger provided or one that has been approved by the manufacturer.

Caution! Connect the charger to a suitable power supply. The voltage requirements can be found on the device case and/or the packaging.



Note: Ensure that there are no kinks in the cable and that it will not be damaged by any sharp objects.

Note: To clean the navigation device, use a moist cloth only.

Note: Do not unplug by pulling on the cable. Doing so could damage the cable!

Note: Use micro SD memory cards only! When using a memory card, make sure that the contacts are clean and undamaged.

Safety guidelines for Installation



Caution! Secure the cradle in such a way that the driver's visibility is not impaired.

Caution! Do not attach the cradle within the deployment zone of airbags.

Caution! When installing the cradle, ensure that it does not represent a risk in the event of an accident.

Caution! Do not run cables directly next to safety-relevant devices and power supplies.

Caution! After installation, check all safety-relevant equipment in the car.

Caution! The car charger cable is to be connected to cigarette lighters with an operating voltage of 12V only.

Preparing your Device for use

Charging the battery



Note: A 12 volt car charger cable is included with your device. An A/C wall charger is also available as an optional accessory. Visit our web store www.navigonusa.com/store/.

- Connect the car charger cable to the navigation device and to the vehicle's cigarette lighter.

Power Interruptions



For more information on setting this option, see **Automatic Standby** in “General Settings” on page 97.

When power to the device is interrupted, the **NAVIGON** device can be configured to put itself into Standby mode to save power. This occurs when the device is on and is disconnected from a power source, such as:

- The vehicle cigarette lighter, or
- A wall outlet.

With this option, after a power interruption, the device waits 30 seconds, then puts itself into Standby mode. When one of the above power interruptions occur, the following message displays a 30 second countdown:

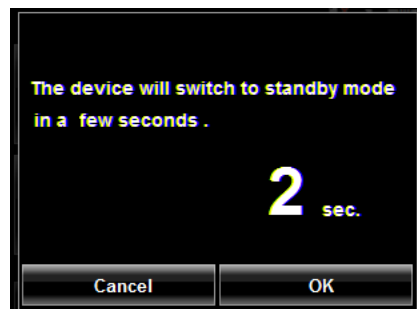

Tap:

- **OK** or wait until the 30 seconds countdown completes to allow the device to enter Standby mode.
- **Cancel** to end the countdown and continue using the device.

Installing the Car Cradle



Caution! Please be sure to read, understand, and follow the safety information in "Important safety information" on page 8.

Assembling the Cradle

- Assemble the cradle as shown below. (No tools are required.)

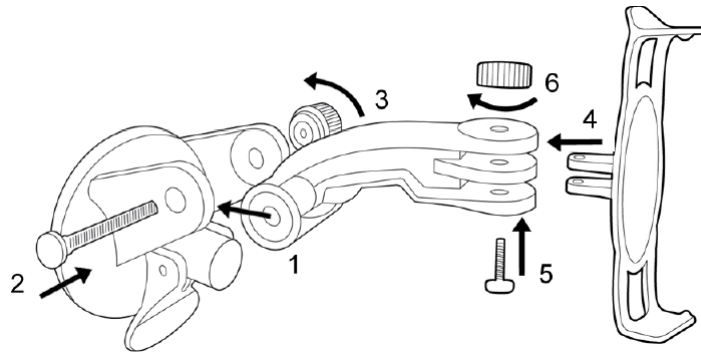

Securing the Cradle

Clean and dry the mounting surface and the suction cup on the base of the mount. These areas must be dry and free of dirt and grease.

1. Open the lever on the suction cup as far a possible.
2. Place the cradle suction cup against the mounting surface.

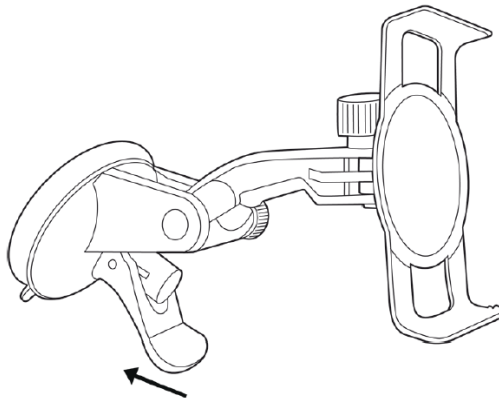

3. Press the suction cup lever down towards the mounting surface.

Placing the Navigation Device in the Cradle

The holder has two small projections on the bottom and one on the top. These projections are designed to fit into corresponding slots on the bottom and top of the **NAVIGON** device.

1. Insert the navigation device into the holder by aligning the bottom projection slots on the bottom of the device.

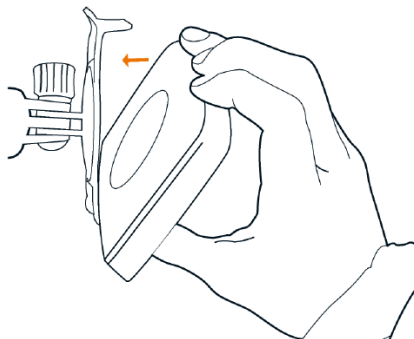

2. Press the device towards the cradle until you hear the upper clip latch into place.
3. Adjust the navigation device so that it can be seen easily.

Powering the navigation device

Included with the **NAVIGON** device is a car charger cable with which power can be supplied to the navigation device using the vehicle's cigarette lighter or power outlet.

The car charger cable is connected to the **NAVIGON** device using the power connection port  (**Power**) on the bottom of the device.



Caution! The car charger cable is to be connected to cigarette lighters with an operating voltage of 12V only.

Optional Accessory Services

These optional accessory services are available for your **NAVIGON** device:

- ZAGAT Survey Ratings and Reviews Points of Interest (POIs).
- NAVIGON FreshMaps (standard with some models)

Optional services are purchased separately.

Activate Accessory Services

Activating ZAGAT POI Accessory

At a retail outlet where **NAVIGON** devices are sold:

1. Purchase an accessory .
2. On the Accessory is the 15 character activation key, three blocks of five characters separated by hyphens. This key is used to obtain a device unlock code.
3. Switch on the device by pressing and releasing the  (**On/Standby/Off**) button. The MAIN WINDOW displays.
4. Tap **Options** > **Service Activation**.

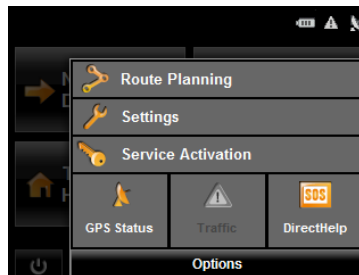

The PRODUCT ID WINDOW displays the 15 character product ID.

5. Record the product ID for the next step.

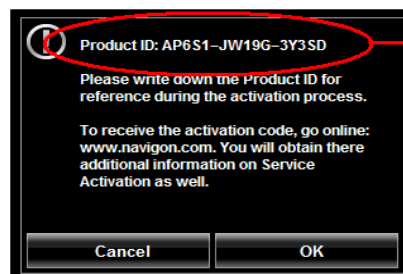

Record the number shown on your device

On a computer with internet access:

6. Go to www.navigonusa.com.
7. On the HOME PAGE, select the **Registration and Activation** tab.
8. Select **Register Your NAVIGON Device** and provide the requested information.
9. When finished, select **Activate Your Service Accessory**.

The website requests your e-mail address, **NAVIGON** device product ID, and the Accessory activation key.

10. Enter the requested information in the appropriate fields.
The website returns your device unlock code, used to unlock the service on the device. The unlock code is also sent to your e-mail address.

On your **NAVIGON** device:

11. On the PRODUCT ID WINDOW, tap **Next**.
The DEVICE UNLOCK WINDOW displays.

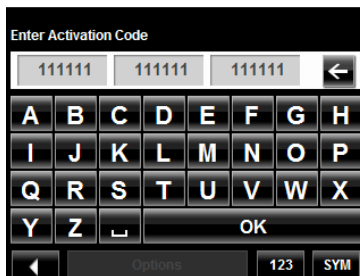



12. In the **Enter Unlock Code** fields, enter the 18 character device unlock code, in blocks of six characters.
13. Tap **OK**.
The ACTIVATION COMPLETE WINDOW displays. The accessory service is now available for use.
14. Tap **OK** to close the window.

Confirming ZAGAT POI Accessory Activation

Select a POI destination (as described in “Selecting a Point of Interest (POI) destination” on page 40). ZAGAT POIs are available for most major cities, such as Chicago, Los Angeles, New York, etc.

All available ZAGAT POIs appear at the top of the returned list. A ZAGAT Icon

() appears in front of the POI. Tap the Information button () to view POI details. For more information on ZAGAT POIs, see “ZAGAT POIs (Optional Accessory)” on page 57.

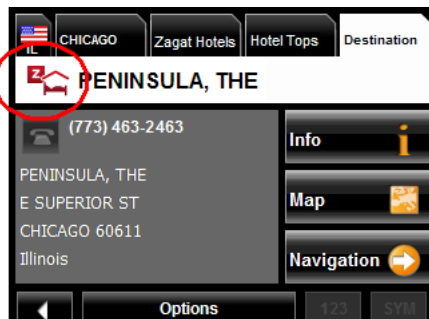

Note: ZAGAT POI information is not available for all locations.

Activating NAVIGON FreshMaps Accessory Service



Note: NAVIGON FreshMaps Disclaimer (General)

NAVIGON FreshMaps is a subscription whose duration is limited to the period described on the purchased product. Internet access and a USB cable (that includes a TYPE-A connector and a MINI-B connector) are required to use NAVIGON FreshMaps. Windows XP or Windows Vista is recommended. Download performance can vary based on bandwidth speeds (broadband internet access is required). To qualify for updates, customers must register their device and activate NAVIGON FreshMaps at www.navigonusa.com/freshmaps within 60 days from the date of purchase or, if FreshMaps comes with your device, 60 days from the purchase date of the device. Software upgrades that could potentially change the user experience may be required to be downloaded in order to receive updates. NAVIGON FreshMaps updates are dependent on the updating of the product's underlying map database provided to NAVIGON by a third party. Therefore, the timing and availability of NAVIGON FreshMaps updates are subject to change based on when the third-party supplier provides updates to NAVIGON. Map data sizes increase and may necessitate additional storage capacity for which the customer will be solely responsible for providing. Retain proof of purchase. For further information, visit www.navigonusa.com.

To activate:

1. Go to www.navigonusa.com
2. Select the **Registration & Activation** tab.
3. Select **REGISTER YOUR NAVIGON DEVICE** and provide the requested information.
4. Select **ACTIVATE YOUR SERVICE ACCESSORIES**.
5. Follow on-screen instructions for activating this accessory service.

This page intentionally left blank.

Basic Operations

Starting the Device

- Press and hold the  (On/Standby/Off) button for two (2) seconds, then release.
After being turned off, when the navigation device is turned back on, the following message appears:



Note: This message does not display if the device is turned back on from Standby.



1. After you have read and fully understood the text, tap **OK**.
The MAIN WINDOW displays.



Note: If you do not accept these instructions, tap **Cancel** to exit the navigation software.

Turning the Device Off



Note: When your device is not in use for an extended period, use this procedure to turn off your device and conserve battery power.

After the device has been turned off, the splash screen re-displays when the device is turned back on.

- Press and hold the  (**On/Standby/Off**) button on the top of the device for eight (8) seconds, then release.

First Time Startup

When you first start your device, the LANGUAGE SELECTION WINDOW displays.



Caution! Selecting the  (**Cancel**) button during these steps will cause the NAVIGON device to cease operation and will require the user to reset the device.



1. Select the appropriate language and tap **OK**.
The DISTANCE UNIT SELECTION WINDOW displays.

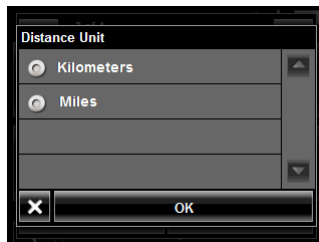

2. Select either **Kilometers** or **Miles** and tap **OK**.
The CLOCK SETTING WINDOW displays.

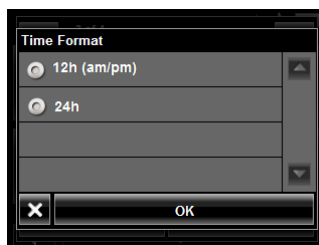

3. Select either **12h (am/pm)** or **24h** and tap **OK**.
The selected options will be used by the device.

The following message displays:

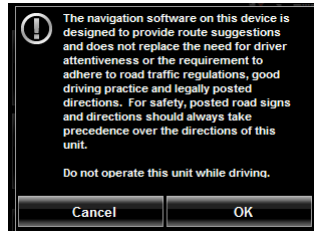

4. After you have read and fully understood the text, tap **OK**.



Note: If you do not accept these instructions, tap **Cancel** to exit the navigation software.

The MAIN WINDOW displays.



You can change these settings at any time. For more information, see “General Settings” on page 97.

Using the Screensaver



Note: When enabled, the screensaver displays a slide show of pictures when you have not touched the device after an extended period of inactivity.

Note: The screensaver is automatically disabled during navigation.

In the MAIN WINDOW:

1. Tap **Options > Settings > General**.
The GENERAL OPTIONS PAGE 1 displays.
2. On PAGE 3, in the **Screensaver** field, tap **Yes**.
3. Tap **OK** to save the change.

Selecting Day/Night Viewing Mode

In the MAIN WINDOW:

1. Tap **Options > Settings > General**.

On GENERAL PAGE ONE:

2. In the **Display mode** field, set the viewing mode. Options are:
 - Automatic** Automatically switch between day and night display, based on sunrise and sunset times.
 - Night** Display with darker colors for night viewing.
 - Day** Display normally for daytime use.



Note: Change day and night brightness levels in the **Brightness Day** and the **Brightness Night** fields.

3. When finished, tap **OK** to return to PAGE ONE.
4. Tap **OK** to save changes.



Viewing Version Information

You can view software version information. This information may be required if you call for customer support. Version information is also useful when NAVIGON offers software and map updates.

In the MAIN WINDOW:

1. Tap **Options > Settings**.

On the SETTINGS WINDOW:

2. Tap **Options > Product Information**.
3. Use  (**Up**) and  (**Down**) to view all of the information.

Using Standby Mode



Note: Use Standby mode only when your device will be unused for a very short time. If left in Standby mode for an extended period, battery drain can occur as the GPS receiver continues to draw power. For longer periods of inactivity, see “Turning the Device Off” on page 18.

Note: To further conserve battery power, the device resets itself if left in Standby mode for a longer time.

Standby mode conserves battery power. When the device is switched back on from Standby, the window that displayed when the device was set to Standby re-displays.

There are two ways to switch your device to Standby.

From the Main Window

On the MAIN WINDOW:



- Tap the  (**Standby**) button.

From Any Device Window

- Press and hold the  (**On/Standby/Off**) button for two (2) seconds, then release.

Switching the Device Back On From Standby

To switch the Device back on:

- Press and hold the  (**On/Standby/Off**) button for two (2) seconds, then release.

The Main Window

The MAIN WINDOW opens when the navigation software starts.

You can reach all of the navigation software functions from this window.

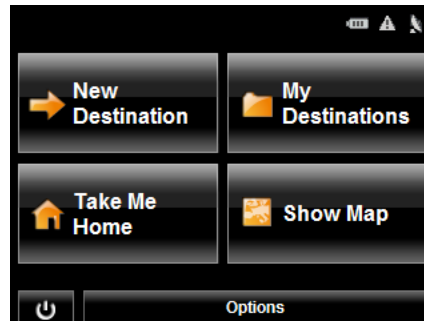

New Destination

Tap this button to:

- Select an address as a destination. (See page 37.)
- Select a POI as a destination. (See page 40.)
- Select a Direct Access POI. (See page 47.)

My Destinations

Tap this button to select a destination from:

- A list of destinations you have saved. (See page 65.)
- A list of the most recently entered destinations. (See page 66.)

Take Me Home

Tap this button to:

- Specify your home address as a destination. (See page 62.)
- Quickly create a route back to your home address from your present location. (See page 64.)

Show Map

Tap this button to:

- Show your location on the current map. (GPS reception required.)
- Select a destination by tapping on the map. (See page 53.)

The Standby Button

- Tap this button  to place the device on Standby and conserve power. (See “Using Standby Mode” on page 21 for more information.)

The Options Button

Tap this button to:

Activate an accessory service:

- Activate ZAGAT Survey Ratings and Reviews POIs.
- Activate NAVIGON FreshMaps.

Access the Route Planning window to:

- Create a route. (See page 67.)
- Save a route. (See page 70.)
- Load a saved route. (See page 70.)
- Run a simulation of a route. (See page 72.)

Access the Settings window to set:

- Navigation options. (See page 95.)
- Route Profile options. (See page 97.)
- Map display options. (See page 96.)
- General options. (See page 96.)
- Additional Options button. (See page 98.)

Go to the GPS Status window to:

- View current GPS status and location information.
- Save the current location as a destination (GPS reception required). (See page 62.)

View the NAVIGON Lifetime Traffic window information. (See page 89.)

(NAVIGON 2200T only)

Go to the DirectHelp window. (See page 29.)

Initializing the GPS receiver



Note: If possible, position the device with a clear line of sight to the sky to successfully receive messages from the GPS satellites.

Note: GPS initialization requires data from at least three satellites. If GPS data is not available, the receiver will not initialize.

Note: It can take up to 20 minutes to initialize the integrated GPS receiver for the first time.

Note: Each time you turn on the device, GPS receiver initialization begins. When GPS data is available, reception starts within one minute.

If the navigation device has been switched to standby for more than a week, the next initialization can take up to 10 minutes.

In the upper right-hand corner of the display, the GPS symbol appears. As soon as data from at least 3 satellites is received, the symbol changes to  (**GPS Ready**).



Note: If the GPS symbol displays **GPS Ready** after considerably less than 20 minutes, it is advisable to leave the receiver switched on for at least an additional 15 minutes to ensure reliable operation.



Caution! The GPS receiver requires a constant supply of power. Leaving the device plugged into your cigarette lighter for a longer period with the vehicle turned off could drain the vehicle battery.

Setting the volume

The volume of the spoken driving instructions can be adjusted during navigation.

With a map displayed:

1. Tap  (**Volume**).

The volume bar opens. It contains three buttons for adjusting the volume:



(**Louder**)



(**Softer**)



(**Mute on/off**).

2. Tap  (**Volume**) again.

The volume bar closes.



Note: When you mute the volume, an icon  appears in the upper right corner of the screen, next to the battery, traffic, and GPS icons. The icon disappears when the volume mute is turned off.

Viewing device status

Symbols located at the top right of the screen are used to display information.

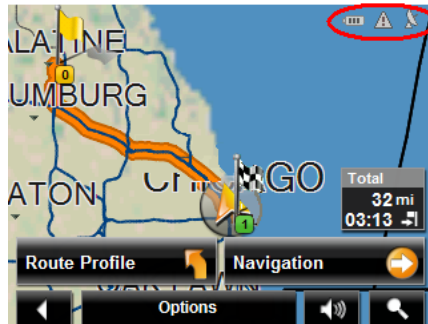

GPS

The GPS symbol can show the following GPS reception status:

No Symbol The built-in GPS receiver is not operational. Contact customer service if the problem persists.



No Signal Data is being received from fewer than three satellites. Position cannot be calculated.



GPS Ready Data is being received from at least three satellites. Position can be calculated.



For more information, see “About GPS navigation” on page 6.

Power



For more information on recharging your device, see “Charging the battery” on page 10.

The Power symbol can display the following conditions of the built-in battery:



The device is powered by an external power source. The battery is charging.



The device is powered by its internal battery. Battery is fully charged.



The device is powered by its internal battery. Battery charge is sufficient.



The device is powered by its internal battery. Battery charge is low.



Caution! When the **No Battery** () icon displays, the battery has no power remaining. The device will soon turn off. See “Charging the battery” on page 12.

Caution! Do not attempt to replace the battery. For problems related to the battery, contact NAVIGON Customer Support.

Traffic Information (TMC) (NAVIGON 2200T only)

The **NAVIGON 2200T**, with a car charger cable with integrated TMC antenna, provides the navigation system with up to date traffic messages. If necessary, it can alter the route dynamically in order to avoid a traffic jam.



Note: This function is only available if TMC traffic messages are being transmitted in the map area in which you are traveling. Traffic messages are not available in all areas.

Note: The charger cable does not need to be connected to the vehicle's cigarette lighter for the antenna to be operational.

Note: Without the antenna, TMC messages may not be received when the device is operating on battery power only.

The TMC symbol can display the following TMC reception status:

No Symbol

TMC is not operational.



Tuning

TMC is operational, but cannot find a station that is transmitting TMC signals.



No Reception

Traffic messages are no longer being received, but there are still traffic messages in the queue that have not expired.



TMC Ready

Traffic messages can be received.



For more information, see “Displaying traffic messages” on page 89.

Using Keyboards

Software keyboards appear on the screen when text entries are necessary. All entries can be made on the software keyboard using the fingertips. Only capital letters can be entered. Three keyboards are available for entering destination information.



Note: When you need to enter a hyphen, use the space button  in place of the hyphen. For example, to enter a hyphenated house number of 20-36 tap two, zero, space, three, six.

Alphabetic keyboard



Tap **ABC** to display the alphabetic keyboard.
Only capital letters can be entered.

Numeric keyboard



Tap **123** to display the numeric keyboard.

Special character/symbol keyboard

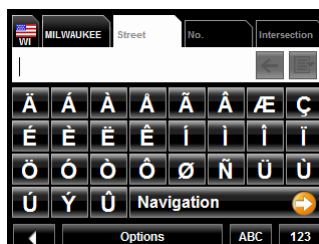

Tap **SYM** to display the special character keyboard.
As soon as you have entered a special character, the Alphabetic keyboard reappears automatically.

Special keys



On the Alphabetic keyboard, enters a space character.
This key is also used to enter a space in place of a hyphen.



On the Alphabetic and Numeric keyboards, deletes the previous character and moves the cursor back one space.



On the Alphabetic and Special Character keyboards, opens the Numeric keyboard.



On the Numeric and Special Character keyboards, opens the Alphabetic keyboard.



On the Alphabetic and Numeric keyboards, opens the Special Character keyboard.

Using menus

Some buttons display menus with options that can be selected.

Tap this button ...

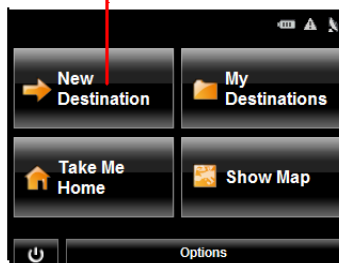

... to display this menu

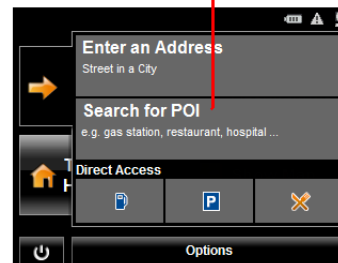

To open a menu:

- Tap on a button to show the menu options.

To close a menu without selecting a function:

- Tap on the button again.

DirectHelp

The NAVIGON DirectHelp feature offers speedy access to emergency POIs. You can quickly find a telephone number, find an address, get directions, and drive to help. DirectHelp also provides you with directional distance to the nearest intersection, and your latitude/longitude location. This information can help emergency personnel quickly come to your assistance.

DirectHelp is available at any time, while you are on-route or off, and with or without GPS reception. The last known GPS position is used when GPS reception is not available. With GPS, you can quickly find help and calculate a route to a DirectHelp POI.

The DirectHelp Window

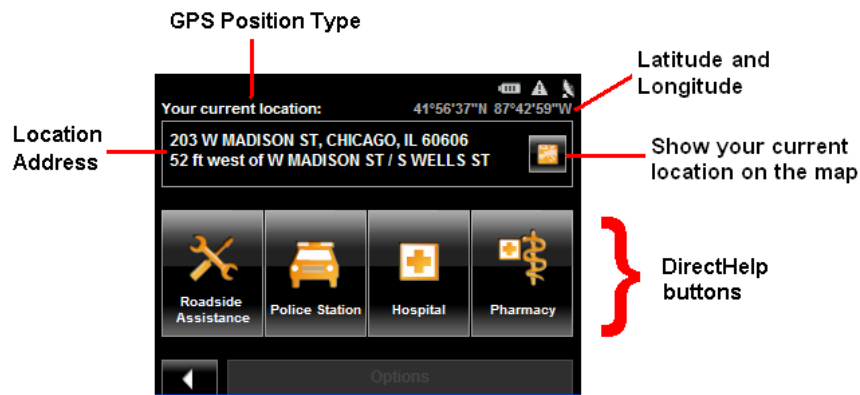

GPS Position Type

The location type indicates whether GPS reception is available or not. If the location type is:

- | | |
|------------------------|---|
| Simulated Position: | Displays only once when neither current or historical GPS position is available. Shown at time of purchase or whenever the device is reset. |
| Your current location: | GPS reception is available. Your current location is shown in the Location Address field. |
| Your last location: | GPS reception has been lost. The last GPS location is shown in the Location Address field. |

Location Address

With GPS reception, the distance to the intersection closest to your present location is shown. If GPS is not available, this is the approximate distance to the closest intersection from the last known GPS position. If the device is located:

- | | |
|--------------------|--|
| On an Unnamed Road | Unnamed Road appears with the distance and direction to the nearest navigable intersection. |
| Off Road | Off Road appears with the distance and direction to the nearest navigable intersection. |



Latitude/Longitude

The latitude and longitude of your current location.



Note: The format of the latitude and longitude can be changed. See “Selecting options” on page 99.

Show Your Current Location on the Map

View your location on a map. Once a DirectHelp POI is selected, tapping this button centers the map on the location of the selected POI. The selected POI is shown as a gray circle. If you have enabled the display of the particular POI icon category (such as Healthcare for Hospital) in map display, the icon and label of the selected POI appears on the map. Changing the zoom level ( **(Zoom In)** or  **(Zoom Out)**) affects whether the icons display.

The crosshairs indicate the center of the map. The name of the POI closest to the center of the map is shown.



DirectHelp buttons

Four DirectHelp POI categories are available:

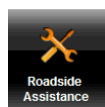

Roadside Assistance



Police Station



Hospital



Pharmacy

DirectHelp returns up to 10 POIs within a 30 mile radius of your location, with the closest POI shown first. If no POIs are found, the following message displays:

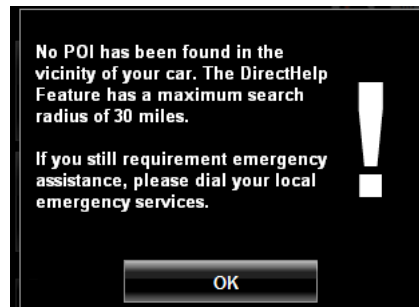

If no emergency POIs are found, seek assistance in the usual manner.

Using DirectHelp

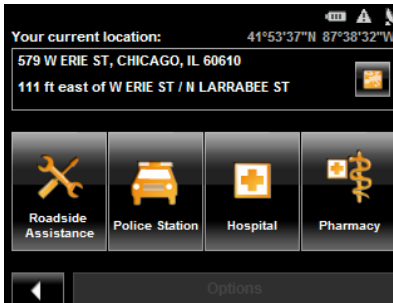

From the MAIN WINDOW:

1. Tap **Options > DirectHelp**.
The DIRECTHELP WINDOW opens.

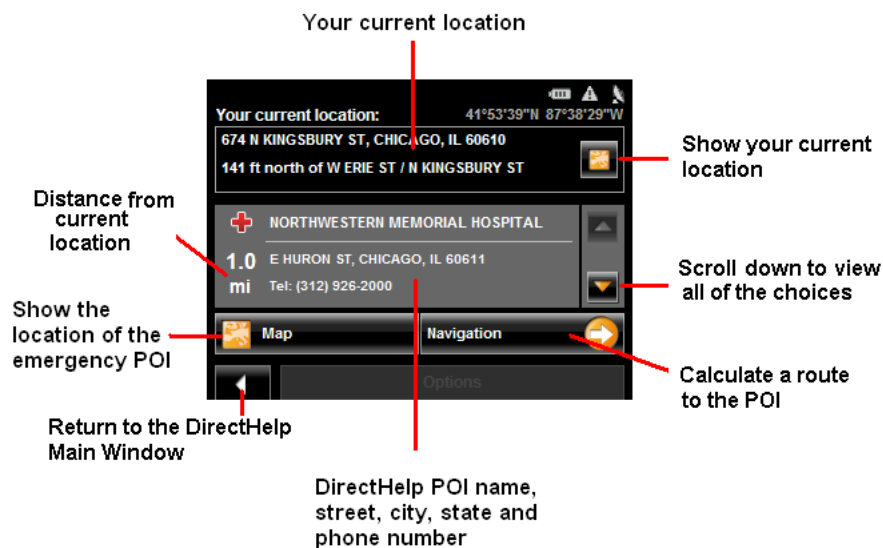

2. Tap on the DirectHelp category button for the type of help you need.
The DIRECTHELP DETAIL WINDOW displays.



3. Use the  (**Down**) and  (**Up**) buttons to select an emergency POI.
4. Tap the  (**Map**) button to show the location of the selected emergency POI.
5. Tap the **Navigation** button to calculate a route to the POI.



Note: If GPS reception has been lost, the route is calculated from the last recorded GPS location.

Destination Selection



Caution! Please be sure to refer to the safety information in “Important safety information” on page 8.

New destinations for the **NAVIGON** device are destinations that you have not yet navigated to or those that you have not yet stored.



You can enter an address, select a POI, or select a destination from the quick search function.

Using auto-complete to select a destination

When you enter a city name, after you type the first letter, the largest city in the search area appears on the CITY OR ZIP CODE TAB. On the keyboard, the only keys available are for the next valid character in a search area name.



To select:

- The city shown, tap  (**OK**).
- A different city, continue typing the city name until the correct city is shown on the CITY OR ZIP CODE TAB. Tap  (**OK**) to select the city.



When entering characters, tap the  (**Back**) button to delete the previous character and move the cursor back one space.



Note: The auto-complete feature is not available for all locations.

The Search Area Tab

When you enter the **New Destination** button on the MAIN WINDOW, the SEARCH AREA keyboard opens. If you are selecting a destination for the first time, the tab appears blank.



The  (**Search Area**) tab, used to select a map area, is located at the top left corner of the destination selection window.

Once an area is selected, a code on the button reflects the selection and the flag of the country appears above it. For example:

If "IL - Illinois" is selected, the tab displays as:



If "QC-Quebec" is selected, the tab displays as:



Note: Only areas that are represented in the currently loaded map can be selected.

Search Areas

Selecting a Search Area Using the Keyboard

To select an area, do the following:

On the MAIN WINDOW:

1. Tap **New Destination > Enter an Address**.
The DESTINATION SELECTION WINDOW opens and displays the Alphabetic keyboard.
2. Tap on the SEARCH AREA TAB.
3. Tap the key of the first character in the state/province within which your location is located.

For example, tap "I" for Idaho.



The name of the first search area beginning with the selected character is shown. On the keyboard, the only keys available are for the next valid character in a search area name.

4. Tap the next characters in the search area name.
5. When the correct state/province name is shown, tap  (OK).

Selecting a Search Area From a List

When you enter the New Destination button on the Main window, the SEARCH AREA keyboard opens. To select an area, do the following:

On the MAIN WINDOW:

1. Tap **New Destination > Enter an Address**.
The DESTINATION SELECTION WINDOW opens.
2. Tap on the SEARCH AREA TAB.
3. Tap  (Area List).

A list of search areas displays.



List of search areas

4. Tap on the state/province in which your destination is located.
5. Tap  (OK).

Ways to Search for Destinations

Enter an Address

You can find an address by entering the state/province, city, street and house number.

Search for a POI



Note: Optional lifetime ZAGAT Survey Ratings and Reviews POI accessory is available. For more information see “ZAGAT POIs (Optional Accessory)” on page 57.

Points of Interest, (POIs) are useful locations that are organized according to particular criteria. POIs include airports, restaurants, hotels, gas stations, government offices, banks, hospitals, shopping centers, etc. Icons representing the POIs can be displayed on the map.

You can search for POIs:

- | | |
|---------------------|---|
| Nearby | POIs nearby are special destinations that are located within a given radius of your current location. This means you can always find the nearest gas station, for example, no matter where you are. |
| In a City | POIs in a given location can be useful when navigating in an unfamiliar town. |
| Statewide | Popular POIs and POIs of national significance in a state/province. Includes airports, national parks, historic sites, etc. This enables you to find places of interest within a state/province. |
| Near a Selected POI | Select a location, then search for POIs near it. For example, search for restaurants close to an airport. No GPS reception is required for this type of search. |

Select a Direct Access POI

POI direct access system contains three categories of special destinations. POIs in your vicinity that correspond to these categories can be listed quickly, without the need for additional entry.

Tap on the Map

You may indicate a destination directly on the map. In addition to towns and streets, you may also select POIs.



Note: Only areas that are represented in the currently loaded map can be selected.

Entering an address

When searching for a location, you do not have to enter all of the address details.

If you do not know the house number, leave the **No.** tab blank. On the **Intersection** tab, enter the name of a nearby cross street and the navigation system calculates a route to the intersection of the specified streets.

In the MAIN WINDOW:

1. Tap **New Destination > Enter an Address.**

The DESTINATION SELECTION WINDOW opens. The search area used in the previous search is shown on the SEARCH AREA TAB.



Note: To select a different search area, tap on the SEARCH AREA TAB, and select the state/province.

The CITY OR ZIP CODE tab opens.



2. Enter the city name or Postal code, then tap  (OK).

- Use the Alphabetic keyboard to type a city name, or
- Use the Numeric keyboard to type the zip or postal code
- Switch between the Alphabetic and Numeric keyboards to type a Canadian postal code.



Note: You can specify just a city name if you prefer a route to the center of the city.

Note: Only the first three characters of a Canadian postal code are supported.

The STREET TAB opens.



3. Enter the name of the destination street, then tap  (OK).
The No. TAB opens.



4. Enter the house number, then tap  (OK).

If you do not know the house number:

- Leave the **No.** tab blank. On the **Intersection** tab, enter the name of a nearby cross street and the navigation system calculates a route to the intersection of the specified streets.
- Tap **Start Navigation** to route to just the street.

If more than one location is found that matches your destination selection info, the **NAVIGON** device displays a list of locations.



Note: The search is performed on the street name and type, directional information (such as North, South, East and West) is not used in the search. The returned list of addresses will have specified street name with any directional indicator.

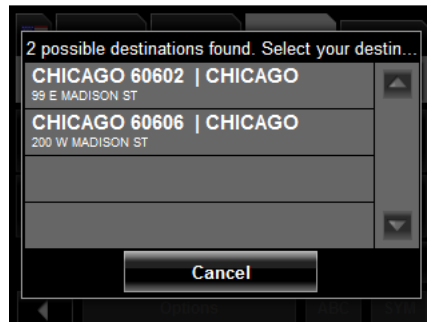

5. Tap on a location to select it.

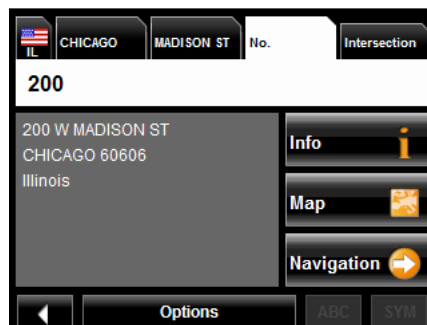

6. Tap **Navigation**.

The map opens in ***Preview mode***.



For more information, see “Starting navigation” on page 55.

Selecting a Point of Interest (POI) destination

POIs nearby



Note: GPS reception must be sufficient to determine your current position. You can see if GPS reception is sufficient by looking at the  (**GPS Ready**) symbol. For more information, see “GPS” on page 25.

In the MAIN WINDOW:

1. Tap **New Destination** > **Search for POI** > **Nearby**.
The CATEGORY tab opens.

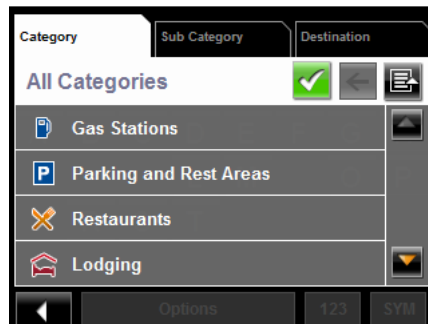

2. Tap on the category from which you would like to select a POI.
The SUB CATEGORY tab opens.

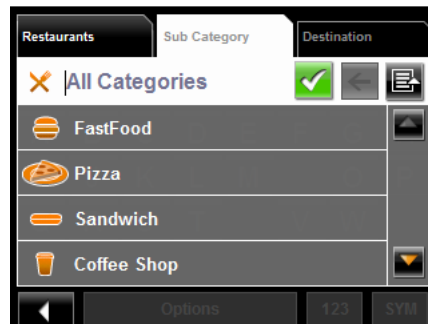

3. Tap on the subcategory from which you would like to select a POI.
The DESTINATION TAB opens.

If more than one location is found that matches your destination selection info, the **NAVIGON** device displays a list of locations.

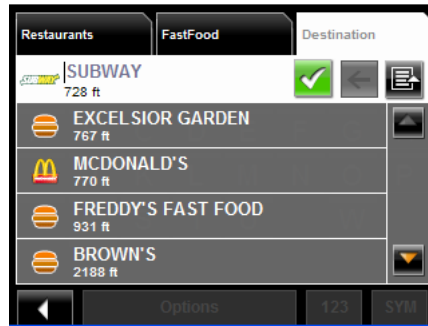

4. Tap on the name of the destination.
Information for the selected POI displays.

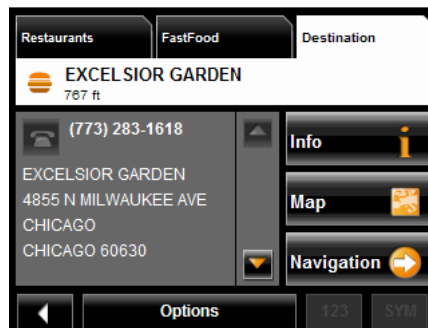

5. Tap **Navigation**.
The map opens in *Preview mode*.



For more information, see "Starting navigation" on page 55.

POIs in a specified city

On the MAIN WINDOW:

1. Tap **New Destination > Search for POI > in a City**.

The DESTINATION SELECTION WINDOW opens. The search area used in the previous search is shown on the SEARCH AREA TAB.



Note: To select a different search area, tap on the SEARCH AREA TAB, and select the state/province.

The CITY OR ZIP CODE tab opens.



2. Enter the city name or ZIP code, then tap  (OK).

- Use the Alphabetic keyboard to type a city name, or
- Use the Numeric keyboard to type the zip code.
- Switch between the Alphabetic and Numeric keyboards to type a Canadian postal code.



Note: Only the first three characters of a Canadian postal code are supported.

The CATEGORY TAB displays.

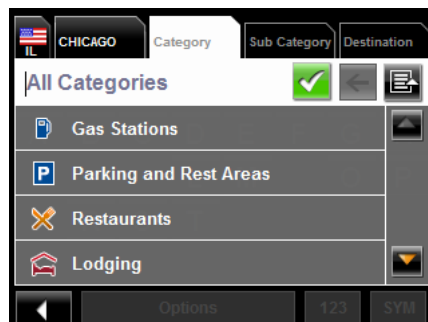

3. Tap on the category from which you would like to select a POI.
The SUB CATEGORY TAB displays.

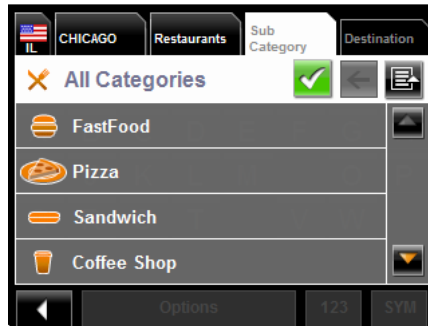

4. Tap on the subcategory from which you would like to select a POI.
The DESTINATION TAB opens.

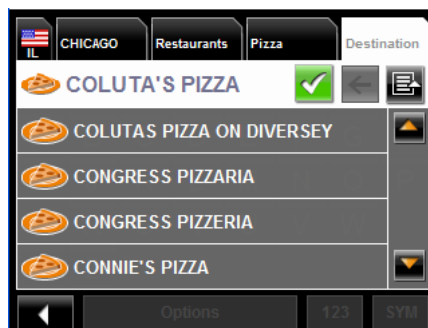

5. Tap on the name of the destination.
If more than one location is found that matches your destination selection info, the **NAVIGON** device displays a list of locations.

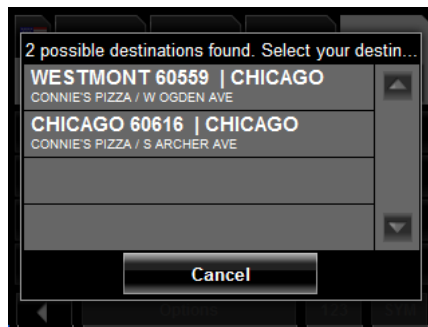

6. Tap on the location you want.
The DESTINATION TAB displays information on the selected POI.



For more on POI information, see “Information about the POI” on page 49.

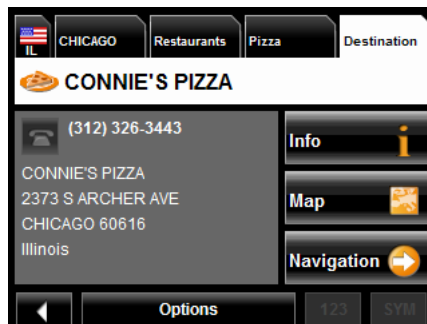

7. Tap **Navigation**.

The map opens in **Preview mode**.



For more information, see "Starting navigation" on page 55.

Statewide POIs

In the MAIN WINDOW:

1. Tap **New Destination** > **Search for POI** > **Statewide**.
The STATEWIDE POI WINDOW opens.

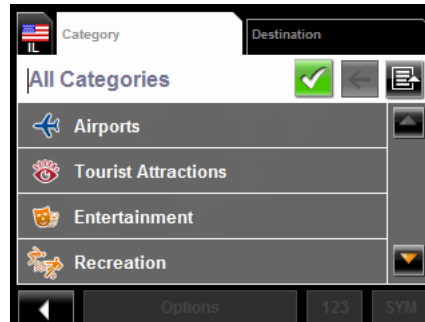

2. Tap on the category from which you would like to select a POI.
The DESTINATION TAB opens.

If more than one location is found that matches your destination selection info, the **NAVIGON** device displays a list of locations.

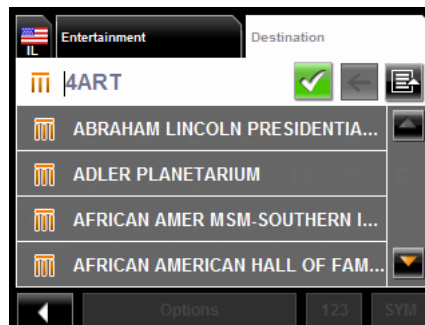

3. Tap on the name of the POI.
The DESTINATION TAB displays information on the selected POI.

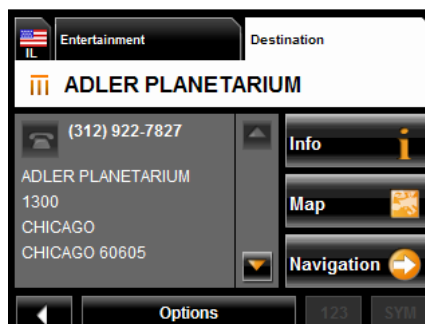

For more on POI information, see "Information about the POI" on page 49.

4. Tap **Navigation**.

The map opens in ***Preview mode***.



For more information, see “Starting navigation” on page 55.

Selecting a Direct Access POI



Note: Sufficient GPS reception is required for Direct Access POIs. You can check GPS reception by looking at the  (**GPS Ready**) symbol.

When you receive your device, the following 3 POI categories are selected for direct access:

- Gas Stations
- Parking
- Restaurants.



Note: To select other types of POIs for direct access, see “Specify Direct Access POI categories” on page 48.

In the MAIN WINDOW:

1. Tap **New Destination**.

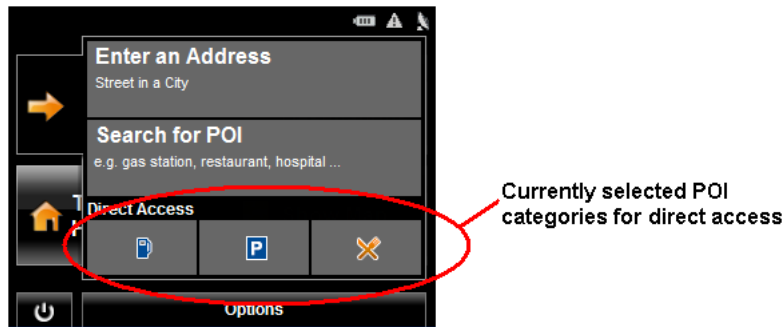

The NEW DESTINATION MENU opens.

The symbols of the categories which have been selected for direct access can be seen in the menu at the bottom.

2. Tap on a category from which you would like to select a POI.
The **Name of the Destination** list opens. It contains the nearest POIs in the specified category, sorted by distance.

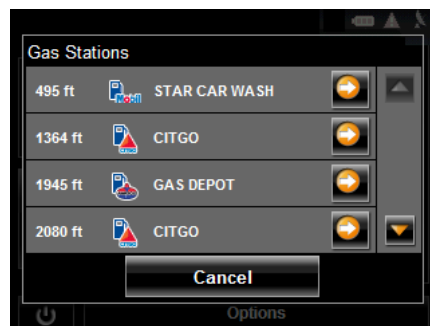

3. Tap on the name of the destination.
The map opens in **Preview** mode.



For more information, see “Starting navigation” on page 55.

Specify Direct Access POI categories

In the MAIN WINDOW:

1. Tap **Options** > **Settings** > **General**.
2. Use  (**Next Page**) to go to PAGE TWO.







3. In the **Direct Access 1** field, tap  (**List**) and select a POI category.
4. Repeat the above step in the **Direct Access 2** and **Direct Access 3** fields.
5. When finished, tap **OK** to save the changes.

Information about the POI

For many POI destinations, additional information is available. For example, telephone numbers are provided for many restaurants, allowing you to call the restaurant and reserve a table ahead of time.



On the DESTINATION SELECTION WINDOW, the following buttons are available:

	Opens the DESTINATION INFO WINDOW and shows basic information about a POI, including address and phone number. Postal codes in Canada will only display the first three characters.
	Show the POI on a map. (GPS reception required.)
	Not available.
	Calculate a route and start navigation to the selected POI.

Searching for POIs Near a Selected Location

With the **NAVIGON** device you can select a location, then search for POIs nearby. For example, if you are traveling for business you can search for restaurants close to your hotel. You can perform this type of search from anywhere - your home, hotel room, airport, etc. No GPS reception is required for this type of search.

On the MAIN WINDOW:

1. Select the location. (See the corresponding section of “Destination Selection” on page 33.)

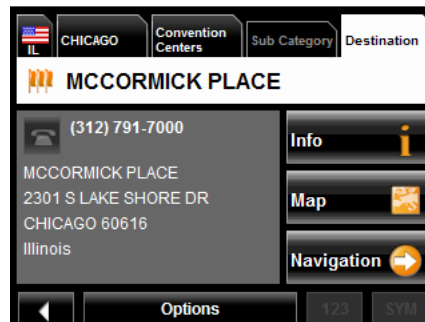

2. Tap **Map**.

The map displays the selected POI centered on the map and the street name of the POI appears below it.

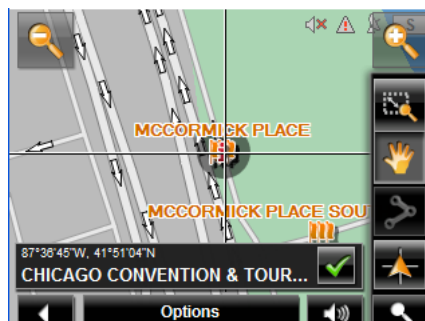

3. Tap  (OK).

The DESTINATION SEARCH MODE WINDOW displays.

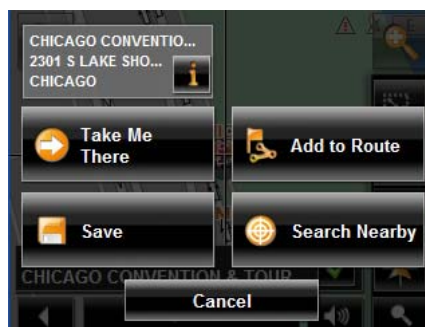

4. Tap the **Search Nearby** button.
The CATEGORY TAB opens.

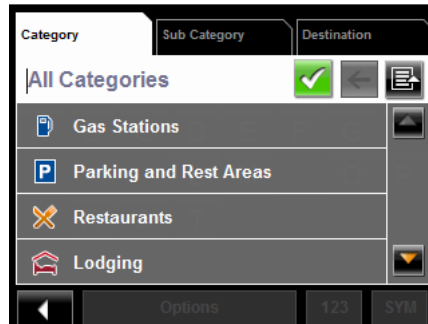

5. Select the POI category
The SUB CATEGORY tab opens.

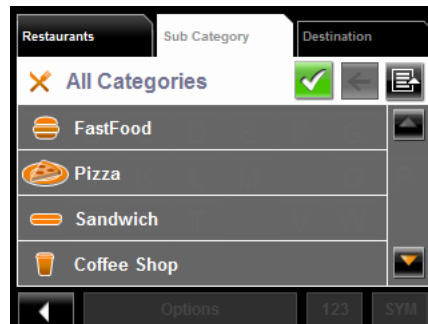

6. Tap on the subcategory from which you would like to select a POI.
The DESTINATION TAB opens. The distance from your current location and the POI is shown.

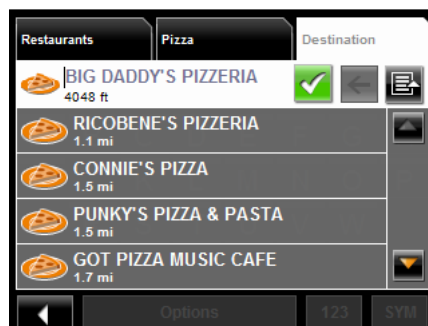

7. Tap on the location you want.
The DESTINATION TAB displays information on the selected POI.



For more on POI information, see "Information about the POI" on page 49.

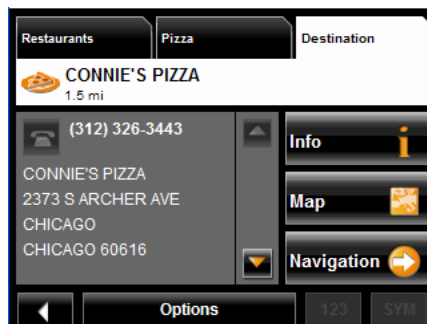

8. Tap **Navigation**.



For more information, see “Starting navigation” on page 55.

Selecting a destination by tapping the map



You can select towns, streets, and even POIs by tapping on the map.

On the MAIN WINDOW:

1. Tap > **Show Map**.

The map opens in *Preview mode*.



Destination search button

2. Tap  (**Destination search**) to display destination search tools.



For more information on using destination search tools, see “Destination Search mode” on page 82.

3. Use the Destination search tools (zoom in, zoom out, pan, etc.) to view the general map area you are interested in.
4. Tap on the point to which you wish to navigate.

The name of the location displays. The selected destination is centered in the map and appears under the cross hairs.

Crosshairs



5. Tap  (**OK**).

The DESTINATION ON MAP WINDOW opens. Detailed address information for the selected destination displays in the upper left-hand corner.

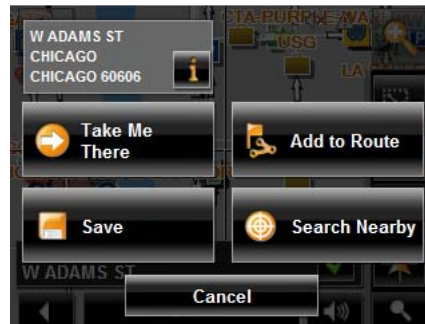

6. Tap the **Take Me There** button.
The map opens in **Preview mode** and shows the route calculated from your current location to this destination.



For more information, see "Starting navigation" on page 55.

Starting navigation

With the map open in **Preview mode**, the destination is shown as a small flag. The route and the estimated trip time are displayed.

With the map open in **Preview mode**:

- Tap the **Navigation** button or simply start driving.

Quitting navigation

- Tap  (**Back**) to quit navigation.
A window prompts you to confirm.

No GPS reception

If GPS reception is insufficient when the **Navigation** button is tapped, the following message appears:

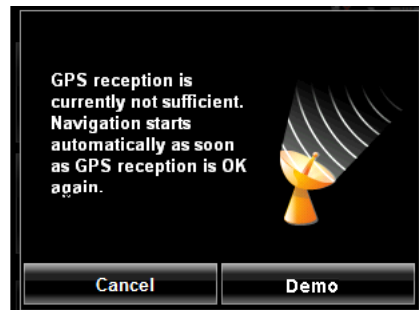

You can:

- Wait until GPS reception resumes for determining position. Navigation begins automatically once GPS reception is sufficient.
- Tap the **Cancel** button. The MAIN WINDOW opens. Your destination is saved in the LAST DESTINATIONS list.
- Tap the **Demo** button. The route is calculated using a nearby location as a starting point. The simulation of the calculated route begins. Tap  (**Back**) to end the demonstration. (The **Demo** button does not appear when the destination was selected by tapping on the map.)

Arriving at your destination

A voice announcement tells you that you have reached your destination. If available, the street name is also given.

Your current position (indicated by an orange triangle) is shown on the map.

If the destination has a house number, the **NAVIGON** device announces which side of the street the destination is on.

This page intentionally left blank.

ZAGAT POIs (Optional Accessory)

ZAGAT Survey Ratings and Reviews POIs can be purchased as an optional accessory.

Once purchased, ZAGAT information is provided for the lifetime of your **NAVIGON** device at no additional charge.

For more on purchasing and activating this accessory, see “Optional Accessory Services” on page 13.

With ZAGAT Survey Ratings and Reviews POIs, you can select from thousands of POIs and view customer survey ratings for a selected POI.

ZAGAT POI Categories

ZAGAT survey information features over 30,000 points of interest (POIs) in hundreds of cities. ZAGAT Survey information is provided in the following five categories:



Attractions Shopping centers and entertainment venues.



Golf Courses Public, semi-private and resort courses.



Hotels Hotels, resorts and spas.



Nightlife Nightspots and dance clubs.



Restaurants Food, decor, service, and cost.

Zagat Ratings

Rating Ranges

Establishments are rated on a scale of 0 to 30 where:

26 - 30	Extraordinary to Perfection.
20 - 25	Very Good to Excellent.
16 - 19	Good to Very Good.
10 - 15	Fair to Good.
0 - 9	Poor to Fair.

Price Ranges

VE	Very Expensive.
E	Expensive.
M	Moderate.
I	Inexpensive.

Rating Basis

Establishments are rated from 0 - 30, based on the following:

ZAGAT POI	Rated on:	Cost Estimate Based on:
Restaurants	Food, Decor, and Service	Price of dinner, one drink, and tip.
Nightlife	Appeal, Decor, and Service	Cost of one drink.
Hotels	Rooms, Service, Dining, and Facilities	High-season rate for a standard double room. Note: Does not reflect price changes and special rates.
Attractions	Appeal, Facilities, and Service	High season price for one adult.

Search for ZAGAT POIs

Once the ZAGAT POI accessory is purchased and activated, ZAGAT POIs are returned with any POI search.



Note: ZAGAT POI information is not available for all locations.

ZAGAT categories appear first in the list of returned locations. A  (ZAGAT POI) appears in front of a ZAGAT category.

View ZAGAT POI Information

On a POI DESTINATION SELECTION WINDOW:

1. Tap on a ZAGAT POI category.
2. If sub-categories exist for the category, tap the subcategory.
3. Tap on the name of a POI.

The DESTINATION INFO WINDOW opens and displays basic POI information.

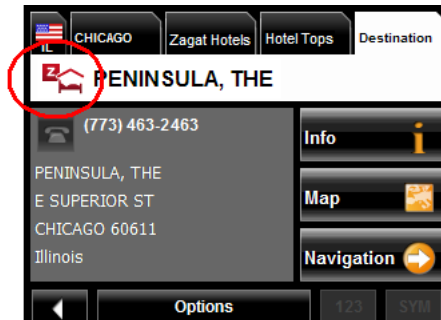

4. Tap **Info** to view ZAGAT survey information about the POI.
The ZAGAT DETAIL WINDOW opens and displays detail information for the POI including hours of operation, costs, offered services, etc.

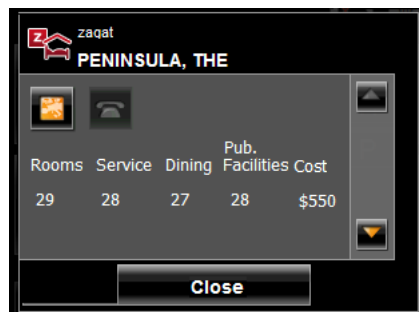

5. Use the  (**Down**) and  (**Up**) buttons to view all of the information.
6. When finished, tap **Close**.

This page intentionally left blank.

My Destinations

My Destinations include a Favorites list of locations you have saved and a Last Destinations list of the last locations your performed a search for. These lists can be useful if you often navigate to particular locations.

Saving a destination to the Favorites List

1. Enter a destination. (See “Destination Selection” on page 33.)
 2. Tap **Options > Save Destination**.
- OR -
1. Select a destination from MY DESTINATIONS. (See page 65.)
 2. Tap **Options > Save Destination**.

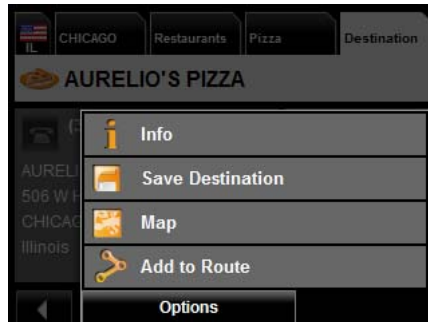

The SAVE DESTINATION AS window displays.

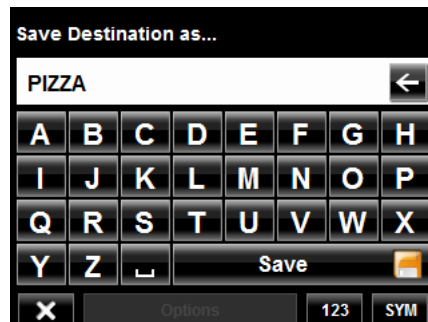

3. Enter the name for the destination.
4. Tap **Save**.

Saving the current location using GPS

The GPS STATUS WINDOW provides you with an overview of the data the navigation system calculates from the received GPS signals.

In the GPS STATUS WINDOW:

1. Tap **Options > GPS status**.

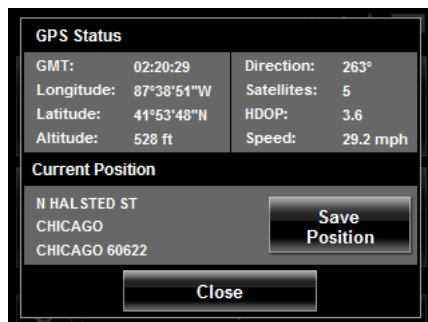

The current location can be stored in the FAVORITES list.

2. Tap the **Save Position** button.
The SAVE DESTINATION AS WINDOW opens.
3. In the **Name** field, enter the name for the destination.
4. Tap the **Save** button.

Saving your home address as a Favorite Destination

You can begin navigation to this destination quickly by tapping the **Take Me Home** button in the MAIN WINDOW. Only one destination from the FAVORITES list can be defined as your home address.

On the MAIN WINDOW:

1. Tap the **Take Me Home** button.
The following message displays:

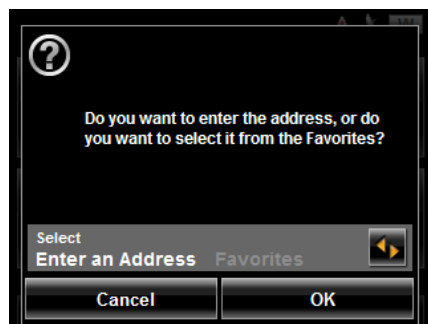

Note: If you do not have any addresses saved in your FAVORITES LIST, the message will ask if you want to enter your home address directly.

2. Use the  (Toggle) button to select:
 - **Enter an Address** - To enter your home address, or
 - **Favorites** - To select an address from your Favorites List.
3. Tap the **OK** button.
If you selected **Enter an Address**, the DESTINATION SELECTION WINDOW displays.
4. Follow procedures for “Entering an address” on page 37.



If you selected FAVORITES, the FAVORITES WINDOW displays.

5. Select your home address and tap  (OK).

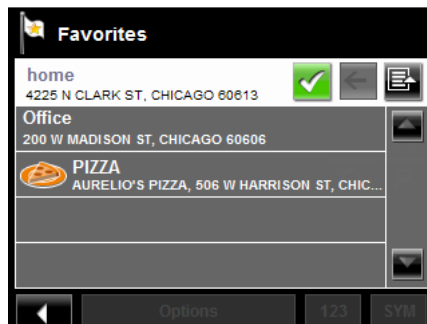

6. Tap **Home Address**.

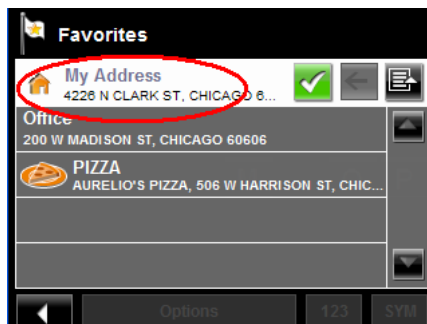

The selected destination is saved as your home address. On the FAVORITES LIST, a house icon displays next to your home address.

Navigating Home

After saving an home address, you can navigate to your home from anywhere by tapping a single button.

The first time you tap the **Take Me Home** button, you are asked to enter your address.

1. Follow procedures for “Saving your home address as a Favorite Destination” on page 62.

In the MAIN WINDOW:

2. Tap the **Take Me Home** button.
Navigation, using the current route profile information to calculate the route, begins.



For more information, “Starting navigation” on page 55.

Selecting a saved destination

The following lists of destinations and addresses are available under **My Destinations**.

Favorites Destinations you have stored in your **NAVIGON** device.

Last Destinations Destinations you have previously navigated to.

Selecting a destination from the Favorites list

Destinations to which you often travel can be saved in the FAVORITES list.

In the FAVORITES LIST, up to 300 destinations can be saved.



Information on how to store a destination can be found in “Saving a destination to the Favorites List” on page 61.

In the MAIN WINDOW:

1. Tap **My Destinations > Favorites**.
The FAVORITES WINDOW displays.

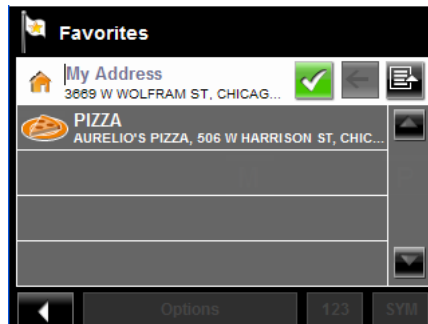

2. Tap the destination to which you would like to navigate.

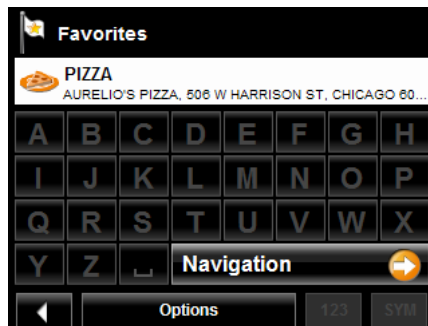

3. Tap the **Navigation** button.
The map opens in **Preview mode**.



For more information, see “Starting navigation” on page 55.

Selecting a destination from the Last Destinations list

Your **NAVIGON** device saves the last 30 destinations to which you have navigated in the LAST DESTINATIONS LIST.

In the MAIN WINDOW:

1. Tap **My Destinations > Last Destinations**.
The LAST DESTINATIONS WINDOW displays.

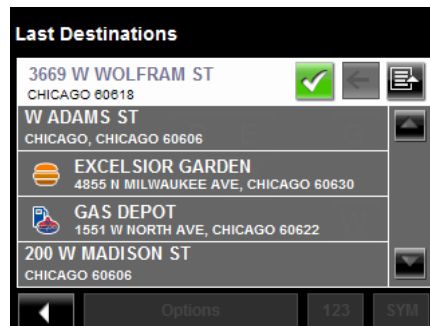

2. Tap the destination to which you would like to navigate.

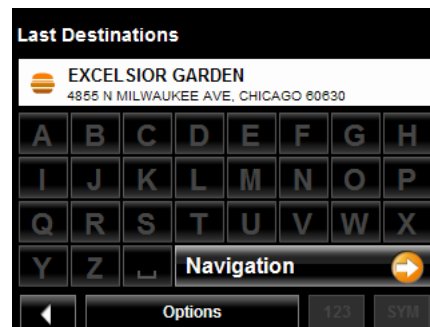

3. Tap the **Navigation** button.

The map opens in **Preview mode**.



For more information, see “Starting navigation” on page 55.

Routes

With the **NAVIGON** device, you can preplan routes. Planned routes can be saved for later use, allowing you to create as many routes as you like.



Route calculations and arrival times are based on the type of vehicle and the route type. Vehicle types (**Speed Profiles**) are: Standard car, Bicycle, or Pedestrian. Route types are Fast, Short, or Optimum. For more information on these settings See "Route Profile Settings" on page 96.

Accessing the Route Planning Window

In the MAIN WINDOW:

1. Tap the **Options** button.
The OPTIONS LIST opens.
2. Tap the **Route Planning** option.
The ROUTE PLANNING WINDOW opens.

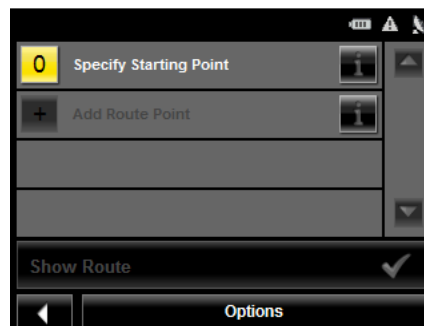

Entering the starting point

The starting point, the point at which you want to begin your trip, is required. This does not need to be your current location. If you are at home planning a route for your vacation, you could, for example, enter your hotel as the starting point.

The starting point is only important if you want to see a planned route on the map, but currently have no GPS reception, or you are not currently at the planned starting point. The starting point that you enter has the flow number "0".

As soon as you begin navigation, your current location is used as the starting point for the route calculation.

Route calculation to the first route point is shown as flow number "1".

On the ROUTE PLANNING WINDOW:

1. Tap the **Specify Starting Point** button.
The STARTING POINT menu opens.

2. Select:
 - **Enter an Address** to search for a location address.
 - **Search for a POI** to search for a POI.
 - **My Destinations** to select a location from the FAVORITES or LAST DESTINATIONS lists.
 - **My Address** to select your home address. (Only available if you have already specified a home address.)
 - **Current Location** to specify your current position as the starting point.
3. Enter the starting point. (See the corresponding section of “Destination Selection” on page 33.)
4. Tap the **Set Starting Point** button.
The selected destination appears next to the “0”, indicating that it is the starting point of the route.

Changing the starting point

On the ROUTE PLANNING WINDOW:

1. Tap the  (**Specify Starting Point**) button.
The STARTING POINT menu opens.
2. Select a different starting point by following the above steps.

Entering route points

Route points are destinations on the route that you want to navigate to.

The flow number for each route point can be found on a button in front of it.

On the ROUTE PLANNING WINDOW:

1. Tap the **Add Route Point** field.
The ROUTE POINT MENU opens.
2. Tap on the button for the desired destination entry type.
3. Enter the route point. (See the corresponding section of “Ways to Search for Destinations” on page 36.)
4. Tap **Add to Route** button.
5. Repeat these steps for each additional destination that you want to add to your route.

Changing the order of route points

Route points can be deleted from a route. The order of the route points can be varied as you wish.



Note: The starting point (flow number "0") cannot be moved or deleted. To change the starting point, create a route point and move the new route point up to the top of the route. The old starting point can now be moved or deleted.

On the ROUTE PLANNING WINDOW:

- Tap on the route point that you want to edit.

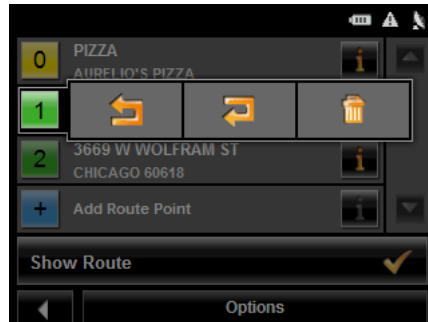

The context menu contains the following buttons:



Route Point Up

Moves the selected route stage forwards.
(Example: route point 2 becomes route point 1).



Route Point Down

Moves the selected route point backwards.
(Example: route point 2 becomes route point 3).



Delete

Deletes the selected route point. A window prompts you to confirm deletion.

Managing routes

You can save each planned route under a particular name.



Note: Only the start point and route points are saved. The calculated route is not. If you load a route that has been saved, it must be recalculated before navigation can begin.

You can load, rename or delete stored routes.

Saving routes

You can save a route after you have entered the starting point and at least one route point.

On the ROUTE PLANNING WINDOW:

1. Tap **Options** > **Save Route**.
2. Enter a name for the route.
3. Tap the **Save** button.

The route is saved to the SAVED ROUTES LIST.

Loading routes

On the ROUTE PLANNING WINDOW:

1. Tap **Options** > **Saved Routes**.
2. Tap the route you want to load.
3. Tap the **Load Route** button.

The ROUTE PLANNING WINDOW displays the starting point and the route points of the selected route.

Navigation

After the route is calculated, you can begin navigation or view a simulation of the route.

Calculating and displaying routes

On the ROUTE PLANNING WINDOW:

1. Load a saved route.
- OR -
1. Enter a starting point and at least one route point.
 2. Tap the **Show Route** button.

The map opens in **Preview mode**.

The starting point and the route points are marked by flags. For each stage, the distance and the estimated trip time is given. This information is also displayed for the entire route.

3. Tap the **Navigation** button or simply start driving.

Viewing or Changing the Route Profile

The calculation of a route is based on route options.

On the ROUTE PLANNING WINDOW:

1. Create a route or load a previously saved route.
2. Tap the **Show Route** button.
The map opens in **Preview mode** and displays the calculated route.
3. Tap the **Route Profile** button.



You can view and, if necessary, change any of the displayed options.



Note: Once options are changed, they remain in effect for all subsequent routes. You can get information regarding changing individual route profiles by tapping the corresponding  (**Help**) button.

Simulating routes

You can also view a simulation of a calculated route.



Note: GPS signal reception is not required for simulation.

Starting a route simulation

You have calculated and displayed a route.

With the route displayed in **Preview mode**:

- Tap **Options > Simulation**.
The route is recalculated for simulation purposes. Simulation begins once calculations have completed.

Ending simulation

You can end simulation at any time.

While viewing the route simulation:

- Tap  (**Back**).
The ROUTE PLANNING WINDOW re-displays.

Viewing a Turn-by-Turn List

You can display detailed directions of the calculated route before starting navigation or at any time during navigation. This list displays all of the driving instructions in table form.

With the route displayed:

- Tap **Options > Turn-By-Turn List**.
The TURN-BY-TURN LIST WINDOW opens.



1. Distance to this junction.
2. Schematic depiction of the next junction where you must turn.
3. Name of the street onto which you must turn.
4. Indicates whether you want to travel on the section of the route.



(Allow) Include this section in the route.



(Forbid) Exclude this section from the route.

Blocking route sections

On the TURN-BY-TURN LIST WINDOW:

1. Tap on the route section you do not want to travel on, so that the  **(Forbid)** symbol appears next to them.

2. Tap  **(Modify Route)**.

The navigation system calculates an alternative route avoiding (if possible) the route sections selected. The new driving instructions are displayed in the TURN-BY-TURN LIST WINDOW.

3. Tap  **(Back)** to close the TURN-BY-TURN LIST WINDOW.

Removing blocks and using original routes

Section blocks can be removed at anytime.

On the TURN-BY-TURN LIST WINDOW:

- Tap **Options** > **Calculate the Original Route**.

Maps

Depending on where your device was purchased, your **NAVIGON** device comes with either a 48 contiguous United States map, or with a full North American map (48 contiguous United States, Alaska, Hawaii, Puerto Rico, Virgin Islands, and all 13 Canadian provinces/territories).

Forty-Eight Contiguous United States Map

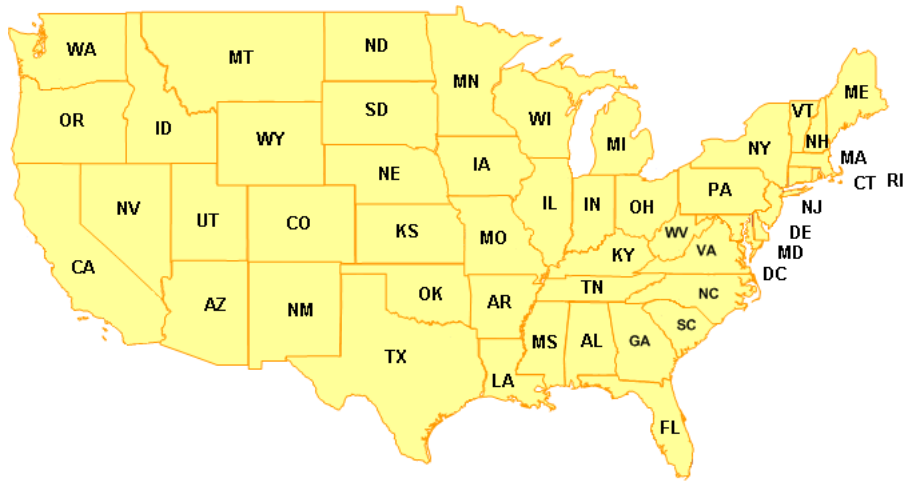

North America Map

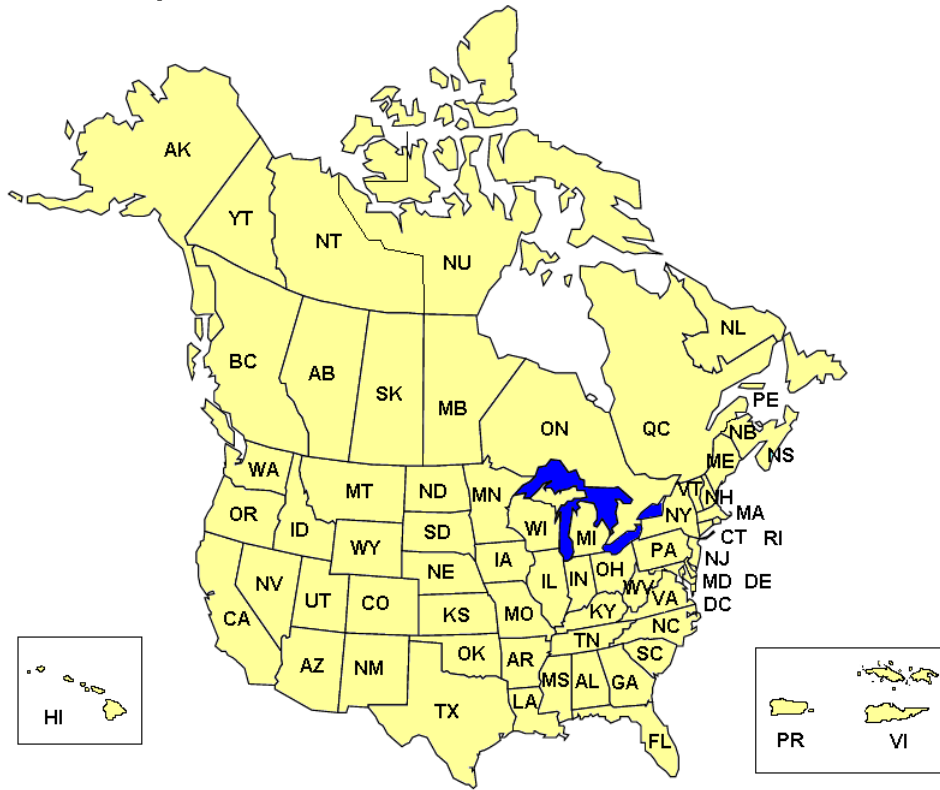

View information on the current map

On the MAIN WINDOW:

1. Tap **Options > Settings > Map Display**.
The MAP DISPLAY WINDOW opens.
2. Use  (**Next Page**) to go to PAGE TWO.

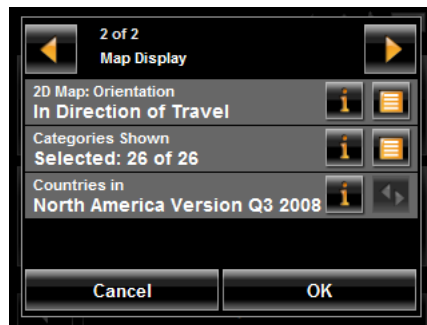

Map Preview mode

You have entered a destination and tapped the **Navigation** button.

- OR -

Create a route or load a saved route, then tap the **Show Route** button.

The map opens in **Preview mode**. The entire route is visible.



1. The route is highlighted in orange.
2. A triangle in orange shows your current position.
If you display a route and the specified starting point is not the same as your current location, the current position may not be shown on the preview.
3. The destination is marked with a small flag.
When you have planned or loaded a route and displayed it, the starting point and each route point is marked with a small flag.
4. The remaining distance to the destination is shown. Tap the box to display the estimated time of arrival () and the time remaining ().

If you are navigating a route with several stages, you see the remaining distance, estimated duration of the trip, and the estimated time of arrival for the next interim destination.

This information can be displayed or hidden by tapping on **Options > Settings > Navigation**.

If you display a route with several stages, information for the current stage is shown.

Tap:

- The **Route Profile** button to view or change settings used to calculate the route.
- The **Navigation** button to begin the journey.
When you display a planned or loaded route, the route may be recalculated. Starting point for the calculation is your current location. Once the route is calculated, you are guided to the first route point.

- **Options > Turn-by-Turn List** to view detailed directions for the route. (See “Viewing a Turn-by-Turn List” on page 73.)
-  (**Destination search**) to view the map in **Destination search mode**.



For more information on using this feature, see “Destination Search mode” on page 82.

Map Navigation mode

After the route has been viewed in *Preview mode*, navigation starts.

Navigation is shown in *Navigation mode*.

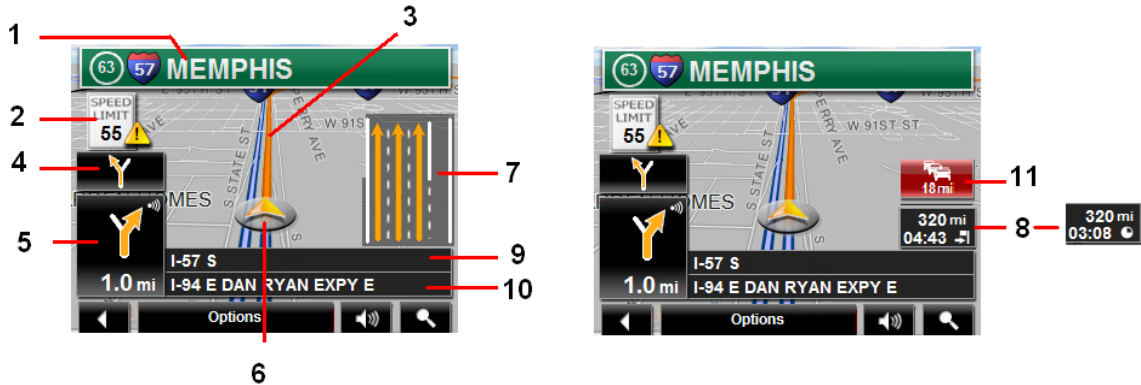



1. Signage to be followed is displayed here.
2. Posted speed limits are displayed here (where available).
3. The route is marked in orange.
4. When two maneuvers need to be executed in quick succession, the small arrow indicates the second maneuver to be executed.
5. The large arrow shows a schematic depiction of the next maneuver. The remaining distance to the junction is displayed below the arrow.

As you get closer to the junction, a vertical bar appears to indicate proximity.



The nearer you get to the junction, the more the vertical bar fills with orange.

If you don't have to change direction for a longer period, you see only a forward-facing arrow. The distance you travel on the road you are on displays beneath the arrow.

- Tap the large arrow to hear current route instructions.
6. An orange triangle shows your current position. The display refreshes as you move so that, in 3-D mode, a greater part of the screen shows the area ahead of you.
 7. Lane Assistant Pro shows the lanes to be followed (in orange) to your destination.
 8. The remaining distance to the destination is shown. Tap the box to toggle to display the estimated time of arrival () and the time remaining ().

If you are navigating a route with several stages, you see the remaining distance, estimated duration of the trip, and the estimated time of arrival for the next interim destination.



9. The name of the stretch of road that you must travel on next.
10. The name of the street you are currently traveling on.

11. (**NAVIGON 2200T** only)  (TMC shortcut button). The TMC shortcut button displays when traffic messages have been received and are currently available. Tap the button to display the NAVIGON LIFETIME TRAFFIC INFORMATION WINDOW.



Note: The displays for many of the above mentioned fields can be configured using **Options > Settings > Map Display**. Information only displays when available.

Note: If you tap on the large arrow, the current route instruction is repeated.

- Tap **Options > Show Turn-by-Turn List** to view detailed directions for the route. (See “Viewing a Turn-by-Turn List” on page 73.)
- Tap  (**Destination search**) to view the map in **Destination Search mode**. (See “Destination Search mode” on page 82.)
- Tap  (**Back**) to quit navigation.

Map functions in Navigation mode

When the map is open in **Navigation mode**, tap any point on the map. Buttons with various functions are displayed.

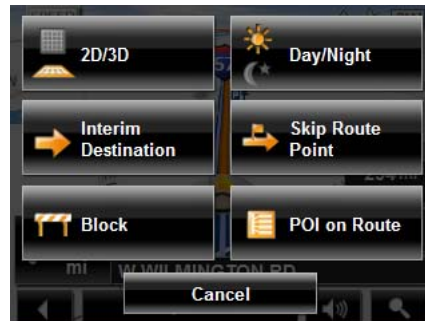

- | | |
|----------------------------|---|
| 2D/3D | Changes between 2D and 3D map views. The symbol for the view currently set is marked orange. |
| Day/Night | Changes between "day" and "night" display. The symbol for the display currently set is marked orange. |
| Interim Destination | Opens a menu for entering an interim destination. The navigation system first guides you to this interim destination. Afterwards, you can simply continue navigation to your original destination. |
| Skip Route Point | Tap this button to omit the next route point. This button is inactive when less than 2 route points are pending. |
| Block | Tap this button to block a section of the route that lies in front of you. The device will recalculate the route and attempt to avoid the blocked section. This can be used if you encounter a stretch of road that is impassable due to its physical condition, weather, or your vehicle's capabilities. |
| POI on Route | Tap this button to display POIs on your route. This enables you to find out, for example, how far it is to the nearest services. A destination shown here can be added as an interim destination by tapping the  (Interim Destination) button to the right of its entry in the list. The three POI categories selected for Direct Access are available. |

Destination Search mode

When in **Destination Search mode**, a pair of cross hairs are shown and the map is always oriented with north up.

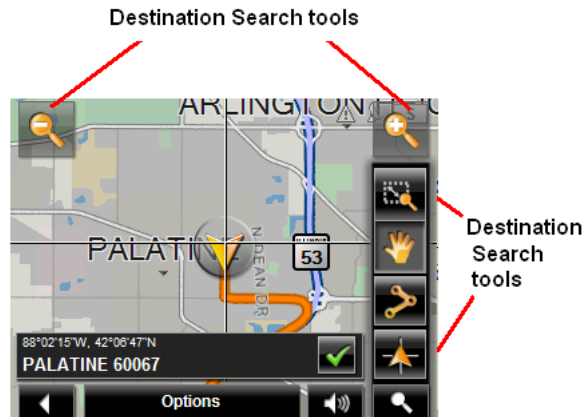

Destination search tools include:



Zoom Out

The map section shown becomes larger, but fewer details are shown.



Zoom In

The map section becomes smaller, but shows more details.



Zoom Mode

When this button is active, you can plot a map section with your finger.

Plot the map section from upper left to bottom right and it zooms to fit the size of the screen.

Plot the map section from bottom right to top left, and the map zooms out.



Pan Mode

When this button is active, you can move the map section with your finger. Tap on the map and drag it in the desired direction.



Entire Route

Zooms the map so that the entire route is visible.





Current Position

Show your current position on the map.

Operating in Destination Search mode

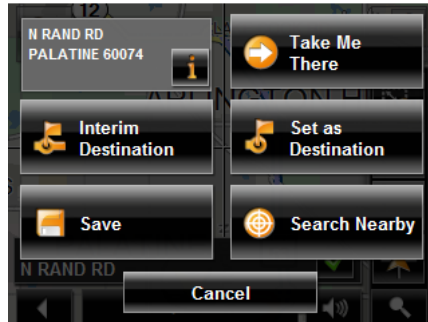
1. Tap on the point to which you wish to navigate.
The destination that you have selected appears under the cross hairs.
2. Tap  (OK).
Buttons with various functions appear.



Detailed address information for the selected destination displays in the upper left-hand corner. Tap  for more information about the POI.

- | | |
|----------------------------|---|
| Take Me There | Begins navigation to the selected point. If you are currently navigating, navigation stops. |
| Interim Destination | Sets the selected point as an interim destination. The navigation system first guides you to this interim destination. Afterwards, you can continue navigation to your original destination.

This function is only active during navigation. |
| Set as Destination | Sets the selected point as the destination. |
| Save | Opens the SAVE DESTINATION AS... WINDOW. You can enter a name for the selected point to be stored in the FAVORITES list. |
| Search Nearby | Opens the POI NEARBY WINDOW. Here you can search for destinations near the specified point. (See "POIs nearby" on page 40.) |

Reality View Pro

When, during navigation, you approach a highway junction, the map changes to **Reality View Pro mode**.



Reality View Pro mode shows the signage and lanes you must follow. This mode displays until you pass the highway junction. Once past the junction, the map returns to **Navigation mode**.

While traveling through the highway junction to:

- Change from **Reality View Pro** back to **Navigation mode**, tap anywhere on the screen.
- Change from **Navigation Mode** back to **Reality View Pro**, tap the **Next Maneuver** button.



Note: **Reality View Pro mode** is not available for every highway junction. Availability is dependent on the map data currently in use.

Turning on Reality View Pro

1. Tap **Options > Settings > Map Display**.
2. In the **Reality View 3D** field, select **Yes** (to show) or **No** (to hide).
3. Tap **OK** to save the changes.

NAVIGON Lifetime Traffic (*NAVIGON 2200T* only)

NAVIGON Lifetime Traffic (TMC) Information allows your *NAVIGON 2200T* to receive the latest traffic information available. If necessary, it can change your route dynamically in order to avoid a traffic jam.



Note: This function is only available if TMC traffic messages are being transmitted in the area in which you are traveling. Traffic messages are not available in all areas.

Note: The charger cable does not need to be connected to the vehicle's cigarette lighter or power outlet for the antenna to be operational.

Note: If the car charger/antenna is not attached to the device, TMC messages may not be received when the device is operating on battery power only.

Accessing the NAVIGON Lifetime Traffic Window

All currently available traffic information can be viewed from the **Options** button on the MAIN WINDOW, ROUTE PLANNING WINDOW and any of the map views.

From any of the above windows:

- Tap **Options > Traffic**.
The NAVIGON LIFETIME TRAFFIC WINDOW opens.

The NAVIGON Lifetime Traffic Window

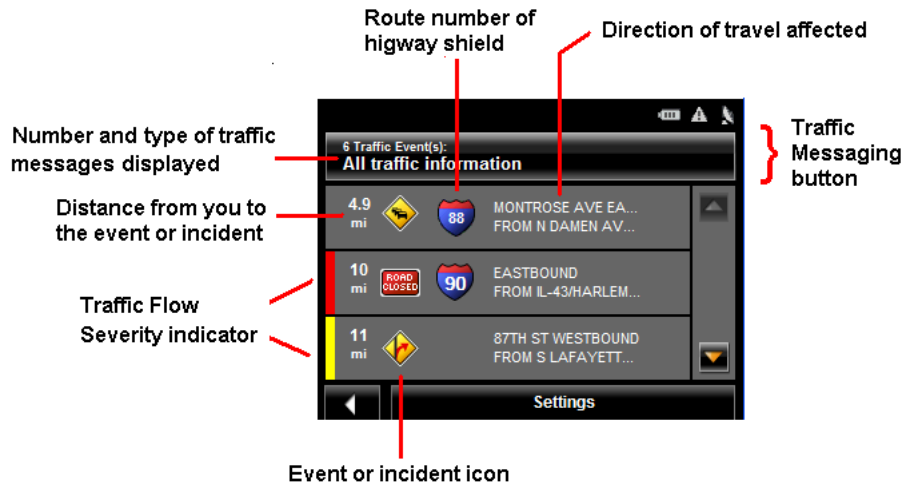

Types of Messages

All traffic information	Information on all traffic events (severe and moderate traffic jams and obstructions) and weather warnings received in the area, based on TMC antenna reception.
On route	Information on all traffic events (severe and moderate traffic jams and obstructions) and weather warnings occurring along the route.
Not on route: all	Information on all traffic events (severe and moderate traffic jams and obstructions) and weather warnings not occurring on the route, based on TMC antenna reception.
Not on route: traffic jams	Information on severe traffic events (traffic jams) not occurring on the route, based on TMC antenna reception.
Not on route: obstructions	Information on moderate traffic events (obstructions) not occurring on the route, based on TMC antenna reception.
Not on route: weather warnings	Information on weather warnings not occurring on the route, based on TMC antenna reception.

Specify the type of traffic messages to display

On the MAIN WINDOW:

1. Tap **Options > Traffic**.

The NAVIGON LIFETIME TRAFFIC INFORMATION WINDOW opens.



On the Navigation map, the  (TMC shortcut) button can also be used to display the NAVIGON LIFETIME TRAFFIC INFORMATION WINDOW. The TMC shortcut button displays when traffic messages have been received and are currently available. See “Map Navigation mode” on page 79.

The **Traffic Messages** button shows the type of traffic messages listed and how many messages of this type are listed.

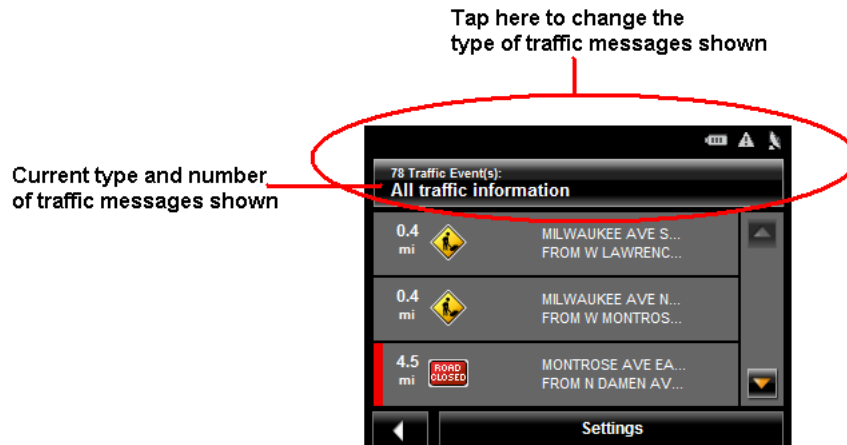

For a description of each message type, see “Types of Messages” on page 86.

2. Tap the **Traffic information** button to view a list of available traffic message types.
3. Tap on the type of messages to display.
4. Tap the **OK** button.

Traffic Flow Severity Indicators

The severity indicator reflects the impact of the traffic occurrence on traffic flow.

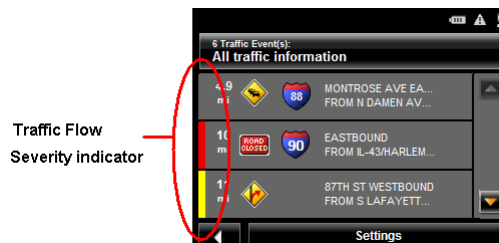

The severity indicator appears as a color bar on the traffic list view. Indicators are

Red	Heavy traffic, expect delays.
Yellow	Moderate impact to traffic.
None	Minor impact to traffic flow.

Event or Incident Icons

On the NAVIGON LIFETIME TRAFFIC WINDOW, the following icons are used to represent traffic events or incidents:



Slow traffic.



Construction.



Accident.



Slippery road due to weather
(snow, ice, rain, etc.).



General problem affecting
traffic flow.



Wind.



Lane closures.



Flooding.



Road closed or blocked.



Informational only. No nega-
tive affect on traffic flow.



Ramp problems. On- or off-
ramp closures, etc.

Displaying traffic messages

The traffic reports that are currently valid are available from several windows.

On the MAIN WINDOW:

1. Tap **Options > Traffic**.

The NAVIGON LIFETIME TRAFFIC INFORMATION WINDOW opens.

Above the list, the **Traffic information** button indicates the type of traffic information listed (on-route, off-route, etc.) and how many messages of this type are listed.

For each traffic message in the list, information about the location and type of traffic obstruction is displayed.

2. Tap a message to view more information on the traffic event.

The TRAFFIC DETAIL WINDOW displays.

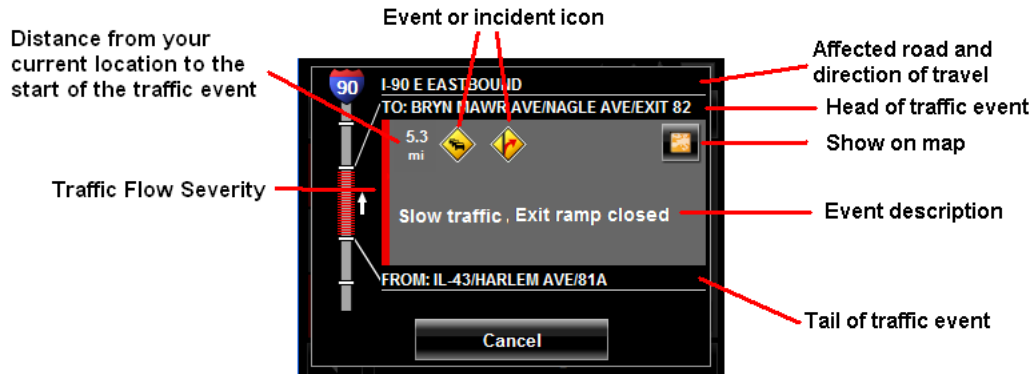

3. When finished, tap the **Cancel** button to return to the NAVIGON LIFETIME TRAFFIC WINDOW.

Select Reroute Settings

You can select whether the navigation software recalculates a route automatically when a TMC message indicates that a problem exists on your current route.

On the TMC STATUS WINDOW:

1. Tap **Options > TMC Settings**.
2. In the **Recalculate Route**, select how you want to set route recalculation:
 - Automatically** The navigation system determines when to recalculate a route and when to ignore a traffic event, based on the severity of the impact on traffic flow. When a traffic message is received that severely impacts your current route, the navigation software displays a message indicating that it has recalculated a route avoiding the event.



Note: Only traffic events with a red severity will be recalculated. Yellow severity traffic events are not recalculated.

On Request Each received traffic message displays on screen. You can specify whether to calculate an alternative route.

3. Tap  (**Toggle**) to switch between options.
The selected value is in bold.
4. Tap **OK** to save your changes.

Reroutes

Requesting a route recalculation



Note: This procedure is only available when the TMC Setting **Recalculate Route** is set to **On Request**. For more information, see “Select Reroute Settings” on page 90.

During navigation, a message displays when a traffic message indicates a traffic event exists on your current route. Details of the event are shown on the TRAFFIC DETAIL WINDOW.

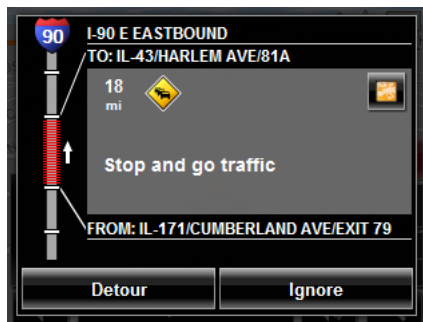

On the TRAFFIC DETAIL WINDOW:

1. Select how you want the traffic block to be handled. Options are:

Detour The navigation software recalculates a route to avoid the traffic obstruction. A (**Detour**) appears next to the traffic segment on the TMC TRAFFIC MESSAGE WINDOW.

Ignore The navigation software ignores the traffic message and remains on the current route. A (**Ignore**) appears next to the traffic segment on the TMC TRAFFIC MESSAGE WINDOW.

The NAVIGON LIFETIME TRAFFIC WINDOW re-displays. An icon for the selected action ((**Detour**) or (**Ignore**) appears next to the traffic segment.

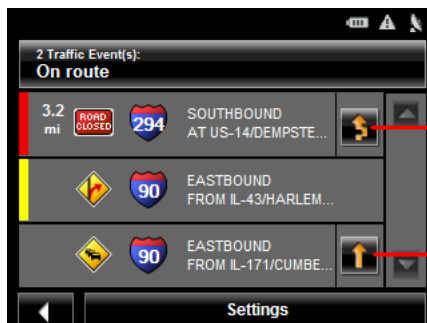



Recalculate the route to detour around this traffic event

Ignore the traffic message and stay on the route

2. Tap (**Back**) to close the NAVIGON LIFETIME TRAFFIC INFORMATION WINDOW.

Canceling a Reroute Calculation for a Traffic Event

If you have set the navigation software to avoid an event and calculate another route, you can cancel the reroute request by tapping  (**Detour**) next to the event. The icon changes to  (**Ignore**) and the route is not recalculated. To change the icon back to **Detour**, tap the **Ignore** icon again.

TMC Status Window

In the TMC STATUS WINDOW, you can set and configure the TMC receiver. These settings determine how received traffic messages will affect subsequent routing.

On the MAIN WINDOW:

1. Tap **Options > Traffic > Settings**.

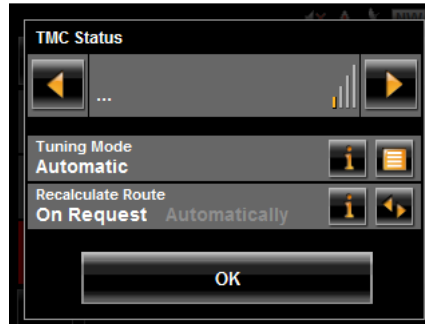

Select another station

On the TMC STATUS WINDOW:

- Tap (To the Left) and (To the Right) to tune to another station.



Note: Some stations do not have TMC information.

Select Tuning Mode Settings

On the TMC STATUS WINDOW:

1. In the **Tuning Mode** field, select an option:
 - Automatically** The system searches for another station if reception becomes poor.
 - Hold station** The system searches for the same station on a different frequency if the signal becomes poor.
 - Hold frequency** The system does not search for another station if reception becomes poor.
2. Tap (List) to view the list and select an option.
3. Tap the **Done** button to save your changes.

Recalculating Route

On the TMC STATUS WINDOW:

- In the **Recalculate Route** field, select an option:
 - On Request** The route is only recalculated when requested.
 - Automatically** The route is automatically recalculated every time a severe traffic event is identified on the route.

This page intentionally left blank.

Customization

Accessing the Settings window

The settings can be reached from several windows.

- Tap **Options** > **Settings**.

The Settings Window

The SETTINGS WINDOW is where you can customize your **NAVIGON** device to suit your personal needs and preferences.

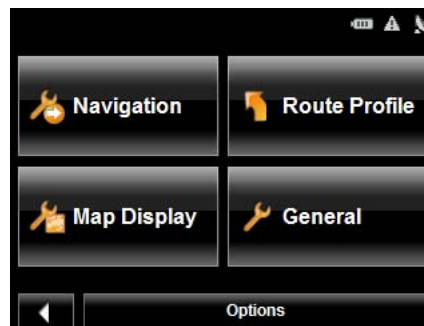

The SETTINGS WINDOW has several buttons.

- Tap a button to open the corresponding settings window.

Navigation Settings

These settings include:

Show Speed Limits

Select whether to show highway speed limits. Options are all speed limits, no special speed limits, or no speed limits.

Within Urban Areas: Warn When Exceeding by

Indicate whether a warning displays when exceeding the speed limit in densely populated areas. Options are to never warn, or to display a warning when 5, 10, 15 or 20 mph over the stated speed limit. Only supported in areas where speed limit information is available.

Outside Urban Areas: Warn When Exceeding by

Indicate whether a warning displays when exceeding the speed limit in less densely populated or rural areas. Options are to never warn, or to display a warning when 5, 10, 15 or 20 mph over the posted speed limit. Only supported in areas where speed limit data is available.

Show Altitude and Speed	Show or hide the altitude and current speed on a displayed map.
Indication of Travel Time	Show either the estimated time of arrival or the remaining time to the destination (or an interim destination, if applicable).
Display Compass	Show or hide a small compass on screen during navigation.
Announce Street Names	Indicate whether or not to hear the street names announced.
Info When Crossing Borders	Show or hide local speed restrictions when crossing a country border.

Route Profile Settings

These settings include:

Speed Profile	Select the type of transport: standard car, bicycle (avoids highways and adheres to one-way restrictions), or pedestrian (avoids highways and disregards one-way street restrictions). This is used for calculating routes and arrival times.
Type of Route	Select the type of route to be calculated: Fast (shortest travel time), Short (shortest travel distance, and Optimum (uses both fast and short segments in the route calculation).
Consider Traffic Information	(NAVIGON 2200T only) Select whether TMC (traffic information) is used when calculating a route. (This requires TMC reception and may not be available in all areas.)
Highways	Select whether highways are considered in a calculated route.
Toll Roads	Select whether toll roads are considered in a calculated route.
Ferries	Select whether ferries are considered in a calculated route.
Residents Only Streets	Select whether residents only streets (where through traffic is prohibited) are considered in a calculated route.
Calculate the Next Stage	Used for routes with multiple destinations. After reaching a route point, select whether the next stage is calculated automatically.

Map Display Settings

These settings include:

Reality View	Indicate whether Reality View Pro displays a visual representation of an approaching junction. Highway signs and the lane to be used are indicated.
---------------------	---

	(This feature is dependent on the selected map and may not be available in all areas.)
3D Maps: Show Street Names	Show or hide street names when displaying the map in 3D view.
2D Maps: Show Street Names	Show or hide street names when displaying the map in 2D view.
2D Zoom Factor	Indicate how auto-zoom behaves by default when a 2D view mode is selected. The zoom changes, based on speed. When driving slower, the map scale gets smaller. When driving faster, the map scale gets larger. Options are no automatic zoom, smaller or larger map sections, or standard.
2D Map: Orientation	Indicate the orientation of maps shown in 2D map view mode. Options are Direction of Travel (at the top of the map), or Always North (North at the top of the map).
Categories Shown	Specify which POI categories are shown on the displayed map.
Countries in	Select the map area to use.

General Settings

Brightness Day	Indicate the display brightness for use during the daytime. Options are from 1 (less bright) to 8 (most bright).
Brightness Night	Indicate the display brightness for use at night. Options are from 1 (less bright) to 8 (most bright).
Display Mode	Select the default display mode for the device. Options are: Automatic (the device switches between modes depending on the time of sunrise and sunset), Day, and Night (the display uses darker colors).
Automatic Standby	Select whether the device will automatically go into standby mode after a period of inactivity or when the power supply to the device is interrupted.
Direct Access 1	Select the first POI category to display for use with the POI direct access and for the POI on route functions.
Direct Access 2	Select a second POI category to display for use with the POI direct access and for the POI on route functions.
Direct Access 3	Select a third POI category to display for use with the POI direct access and for the POI on route functions.
Time Format	Indicate how times are displayed, either a 12 hour format (with am and pm), or a 24 hour format.

Distance Unit	Indicate the distance unit to be used, either Miles or Kilometers.
Coordinate Format	If coordinates are shown, indicate whether they display in decimal format or in degrees, minutes, and seconds format.
Screensaver	Indicate whether a screensaver should display after a period of inactivity.
Language	Select the language to be displayed on screen and to be used with spoken directions. Options are English, Spanish, or French.
Voice	Select the appropriate voice to be used with spoken navigation instructions.

Options Button

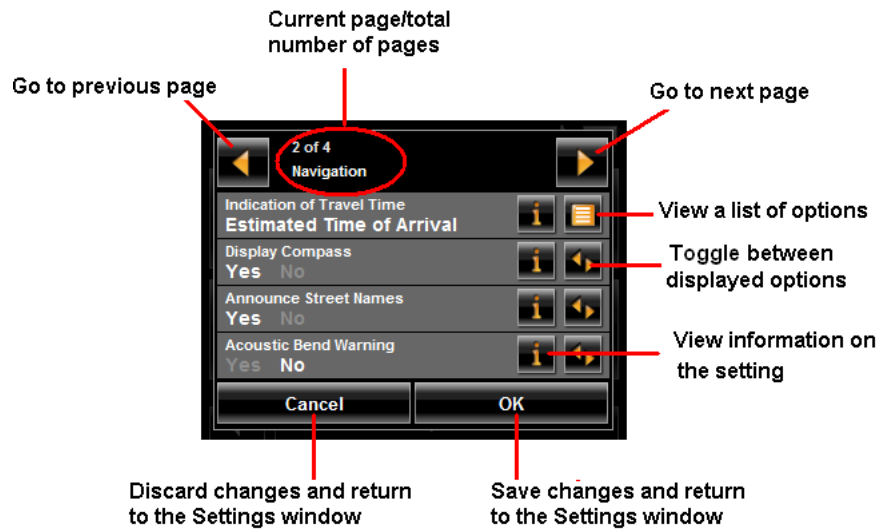

Product Information	Select this option to view NAVIGON device software and hardware versions, as well as, information on the maps, traffic, and ZAGAT POIs.
Touchscreen Calibration	Select this option to recalibrate the touchscreen.
Factory Settings	Select this option to reset the device to default values.

Selecting options



Moving between pages

Some **NAVIGON** device settings require several windows, as shown in the example above (Page 2 of 4). To move between windows:

- Tap  (To the Left) and  (To the Right).

Viewing a list of options for a setting

Some settings have several values. A value can be selected from a list. The value that is currently valid is shown.

1. Tap  (List).
A list with all potential values opens. The value that is currently valid is marked.
2. Tap the desired value. It is now marked.
3. Tap the **OK** button.
The list closes. The new value is displayed.

Viewing information about a setting

For each setting, tap the  (**Help**) button to view an explanation of the setting.

Toggling between options

Some settings can only accept two or three different values. All values are displayed with the currently selected value shown in white.

- Tap  (**Toggle**) to alternate between the potential values.

Changing an option setting

After changing an option setting:

- To save the change, tap the **OK** button.
- To discard the change, tap the **Cancel** button.

The SETTINGS WINDOW re-displays.

Legal Notices

NOTICE TO DRIVERS IN CALIFORNIA AND MINNESOTA

State law prohibits drivers in California and Minnesota from using mounts on their windshields while operating motor vehicles. NAVIGON does not take any responsibility for any fines, penalties, or damages that may be incurred as a result of disregarding this notice. (See California Vehicle Code Section 26708(a); Minnesota Statutes 2005, Section 169.71)

GPS

Underwriters Laboratories Inc. ("UL") has not tested the performance or reliability of the Global Positioning System ("GPS") hardware, operating software or other aspects of this product. UL has only tested for fire, shock or casualties as outlined in UL's Standard(s) for Safety for Information Technology Equipment (UL 60950-1, cUL 991). UL Certification does not cover the performance or reliability of the GPS hardware and GPS operating software. UL MAKES NO REPRESENTATIONS, WARRANTIES OR CERTIFICATIONS WHATSOEVER REGARDING THE PERFORMANCE OR RELIABILITY OF ANY GPS RELATED FUNCTIONS OF THIS PRODUCT.

This page intentionally left blank.

Technical Data

Specifications

Dimensions		approx. 3.77" x 2.85" x 0.69"
Weight		approx. 4.3 ounces
Operating conditions	Operating temperature	-10°C to +60°C
	Storage temperature	-30°C to +70°C
	Humidity	0% to 90%, non-precipitating
CPU		Centrality ATLAS III AT642D-XAC 375 MHz
Operating System		Microsoft Windows CE .Net 5.0
Display		3.5" TFT QVGA Color display Resistive flat touch panel 320 x 240 pixels, (QVGA) Landscape format, permeable
Memory	ROM	2 GB mDoc Flash
	RAM	64 MB DRAM
GPS		Built-in (SiRF GRF3i+ with InstantFix II) Built-in antenna
TMC		None (NAVIGON 2000S and NAVIGON 2090S) (NAVIGON 2200T)
I/O	Stylus	No
	Keyboard	Software keyboard
	Loudspeaker	Built-in
	Microphone	None
	Storage	2 GB Built-in
	Memory slot	MicroSD
	USB	USB 1.1
	Bluetooth	None
Power Supply		USB socket
Rechargeable battery	Type	LiPo/Lilon 740mAh, non removable, input voltage 5 VDC
	Period of operation	approx. 1-2 hours ¹
Charging	Electronic	Built-in
	Duration	approx. 2-3 hours

Technical Data
Specifications

Car charger cable	Type	None (NAVIGON 2000S and 2090S) With integrated TMC antenna (NAVIGON 2200T)
	Input	12V DC
	Output	1A, 5V DC
	Operating Temperature	-10°C to 60°C

1. Some features can reduce battery operation time. These include NAVIGON Lifetime Traffic (**NAVIGON 2200T** only), GPS antenna reception, Daytime viewing mode, etc.

Compliance Notices

This **NAVIGON** device complies with Part 15 of the FCC interference limits for Class B digital devices for home or office use.

“Operation is subject to the following two conditions: (1) this device may not cause interference, and (2) this device must accept any interference, including interference that may cause undesired operation of the device.”

(Carrier frequency: 1575.42MHz, receiver only)

Federal Communication Commission Interference Statement

This equipment has been tested and found to comply with the limits for a Class B digital device, pursuant to Part 15 of the FCC Rules. These limits are designed to provide reasonable protection against harmful interference in a residential installation. This equipment generates, uses and can radiate radio frequency energy and, if not installed and used in accordance with the instructions, may cause harmful interference to radio communications. However, there is no guarantee that interference will not occur in a particular installation. If this equipment does cause harmful interference to radio or television reception, which can be determined by turning the equipment off and on, the user is encouraged to try to correct the interference by one of the following measures:

- Reorient or relocate the receiving antenna.
- Increase the separation between the equipment and receiver.
- Connect the equipment into an outlet on a circuit different from that to which the receiver is connected.

Consult the dealer or an experienced radio/TV technician for help.

This device complies with Part 15 of the FCC Rules. Operation is subject to the following two conditions: (1) This device may not cause harmful interference, and (2) this device must accept any interference received, including interference that may cause undesired operation.

This device and its antenna(s) must not be co-located or operating in conjunction with any other antenna or transmitter.

FCC Caution: Any changes or modifications not expressly approved by the party responsible for compliance could void the user's authority to operate this equipment.

Canada C Request

Country Code selection feature to be disabled for products marketed to the US/CAN-ADA

Operation is subject to the following two conditions: (1) this device may not cause interference, and (2) this device must accept any interference, including interference that may cause undesired operation of the device. This Class [B] digital apparatus complies with Canadian ICES-003.

This Category II radiocommunication device complies with Industry Canada Standard RSS-310.

This page intentionally left blank.

Index

A

accessory services	13
activation	
NAVIGON Freshmaps	15
NAVIGON Lifetime Traffic	13
ZAGAT POIs	13
activation confirmation	14
ZAGAT POIs	14
arriving at your destination	55, 74

B

battery	
charging	10
button	
options	23

C

charging the battery	10
compliance notices	105
Canada C Request	105
FCC Interference Statement	105
configuration	95
options	
move between pages	99
save changes	100
selecting	99
toggle between options	99
view a list	99
view information	99
conventions used in the user guide	1
customer support	3
e-mail	3
telephone	3

D

Day/Night viewing mode	
setting the	19
description	5
destination	
arriving at your	55
new location	
select by city	37
quit navigation	55
search for ZAGAT POI	58
select a map area	34
start navigation	55
no GPS reception	55

Take Me Home	64
destination search map mode	82
using	83
destination search mode	82
using	83
destination selection	33
direct access POIs	36
entering an address	36, 37
home address	64
My Destinations	61, 65, 66
saving a Favorite	61
saving the current location using GPS	62
saving your home address	62
POI information	49
search area tab	34
search for POIs	36
select a search area	34, 35
tap the map	36
tapping the map	53
using auto-complete	33
ways to search for destinations	36
ZAGAT POIs	57
categories	57
view information	59
device status symbols	25
GPS	25
power	25
traffic	26
Direct Access POIs	47
specify categories	48
DirectHelp	29
buttons	30
GPS position type	29
Location address	29
location latitude and longitude	30
no POIs found	31
show on map	30
using	32
DirectHelp window	29

E

e-mail support	3
end user license	iii
ending	
a route simulation	72
entering an address	37
EULA	iii

F

Favorites List	65
first time startup	18
from a list	35

G

GPS

about navigation	6
impaired reception	6
initializing the receiver	24
no reception	55
status symbol	25

H

home address	64
saving	62
hyphens, entering	27

I

installation

assembling the cradle	11
placing the device in the cradle	12
securing the cradle	11
installation safety	9

K

keyboards

alphabetic	27
numeric	27
special character/symbol	27
special keys	28
using	27

L

Lane Assistant Pro	79
Last Destinations List	66
legal notices	101
GPS	101
notice to drivers in California and Minnesota ..	101
liability	2
license	iii
loading	
routes	70

M

Main window	22
My Destinations button	22
New Destinations button	22
Options button	23
Show Map button	22
Standby button	22
Take Me Home button	22
main window	17, 19

manual

conventions	1
symbols	1

map modes

destination search map	82
using	83
navigation map	79
functions	81
preview map	77
Reality View Pro	84
maps	75, 77, 79, 81, 82, 83, 84
forty-eight contiguous United States and DC ...	75
North America	76
viewing information on the current map	76

menus

using	28
My Destinations	61
Favorites	
saving a destination	61
saving the current location using GPS	62
saving your home address	62
selecting a saved destination	65
from the Favorites List	65
from the Last Destinations List	66

N

navigation	71
arriving at your	55
quit	55
route profile	71
start	55
no GPS reception	55
turn-by-turn list	73
blocking route sections	73
removing route section blocking	74
navigation device safety	9
navigation map mode	79
functions	81
navigation mode	79
functions	81
navigation safety	8
NAVIGON Freshmaps	
activation	15
NAVIGON Lifetime Traffic	
accessing the TMC window	85
activation	13
cancel a reroute calculation	92
displaying traffic messages	89
event or incident icons	88
request a route recalculation	91
select reroute settings	90
TMC window	86
traffic flow severity indicators	87
types of messages	86
specify	86
NAVIGON webshop	4

O

options button 23

P

POI information window 49
POI searches 36
 categories 57
 direct access POIs 36, 47
 specify direct access POI categories 48
 in a city 42
 near a selected location 50
 Nearby 40
 POI information 49
 statewide 45
 tap the map 36
 ZAGAT POI information 57, 59
power
 status symbol 25
power interruptions 10
powering the device 12
preview map mode 77
preview mode 77

Q

quit
 navigation 55

R

Reality View Pro 84
recalculate a route 93
recalculate route 90
reroutes
 cancel a reroute calculation 92
 request a route recalculation 91
 select settings 90
route planning 67
route points
 changing a starting point 68
 changing the order of 69
 delete 69
 entering a route point 68
 entering a starting point 67
route profile 71
routes 67
 accessing the route planning window 67
 arrive at your destination 74
 calculating and displaying 71
 changing a starting point 68
 changing the order of route points 69
 entering a route point 68
 entering a starting point 67
 manage 70

loading 70
saving 70
navigation 71
route profile 71
simulation 72
 ending a 72
 starting a 72
starting point
 changing 68
 current location 67
turn-by-turn list 73
 blocking route sections 73
 removing route section blocking 74

S

safety information 8
 installation 9
 navigation 8
 navigation device 9
saved destinations
 selecting 65
 Favorites List 65
 Last Destinations List 66
saving
 routes 70
screensaver
 using the 19
search areas
 search area tab 34
 select from a list 35
 select using the keyboard 34
selecting a saved destination 65
 from the Favorites List 65, 66
setting
 device volume 24
settings
 configuration 95
 move between pages 99
 save changes 100
 selecting 99
 TMC 93
 toggle between options 99
 view a list 99
 view information 99
Settings window 95
 accessing 95
simulation
 ending a route 72
 starting a route 72
special keys 28
start
 navigation 55
 no GPS reception 55
starting
 a route simulation 72
startup

first time	18
switching the device back on	21
symbols used in the user guide	1

removing route section blocking	74
volume	
setting device	24

T

Take Me Home	64
tapping the map	53
technical data	103
specifications	103
telephone support	3
TMC	
accessing the TMC window	85
recalculate a route	93
recalculate route	90
tuning	93
TMC settings	
recalculate route	90
trademarks	2
traffic	93
accessing the TMC window	85
cancel a reroute calculation	92
displaying traffic messages	89
event or incident icons	88
select a route recalculation	91
select reroute settings	90
status symbol	26
TMC window	86
traffic flow severity indicators	87
types of messages	86
specify	86
traffic information	
recalculate route	90
settings	93
tuning	93
tuning	
TMC	93
turn-by-turn list	73
blocking route sections	73
removing route section blocking	74
turning on the device	17
turning the device off	18

U

using standby	21
from any device window	21
from the Main window	21
using the keyboard	34

V

version information	
viewing	20
viewing	
turn-by-turn list	73

W

ways to search for destinations	36
direct access POIs	36
entering an address	36
search for POIs	36
tap the map	36
webshop	
The NAVIGON	4
what's included	7
windows	
accessing the TMC	85
DirectHelp	29
Main	22
POI information	49
route planning	67
TMC	86

Z

ZAGAT POIs	57
activation	13
activation confirmation	14
categories	57
view information	59