

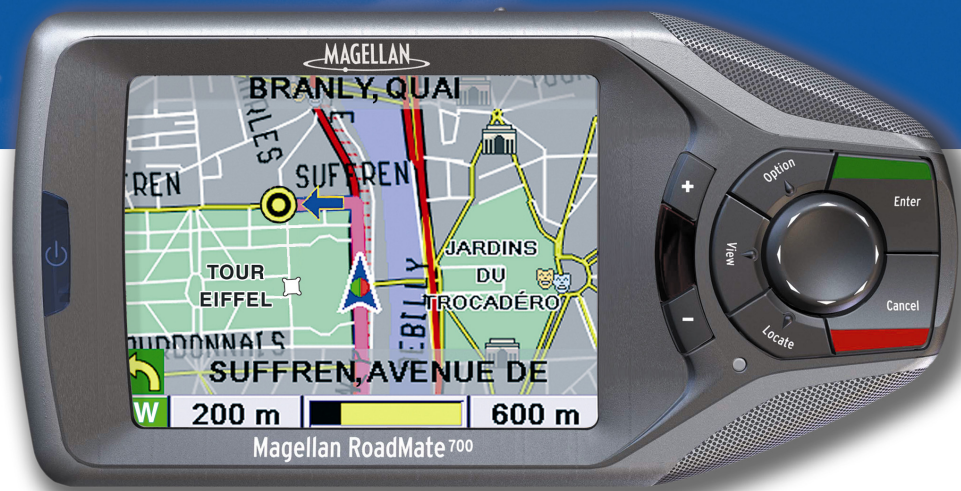

# Magellan<sup>®</sup> RoadMate<sup>™</sup>



## Reference Manual

## Magellan RoadMate 700

Thales Navigation  
ZAC de la Fleuriaye  
BP 60433  
44474 Carquefou cedex  
France  
[www.magellangps.com](http://www.magellangps.com)

PN 631161-18A

## \*\*\* IMPORTANT SAFETY WARNINGS \*\*\*

The Magellan RoadMate is a vehicle navigation aid designed to assist you in arriving at your selected destination. When using the Magellan RoadMate, these safety rules must be followed to prevent accidents that can result in injury or death to yourself or others:

- When driving, the need to view the display is minimal. Voice prompts will guide you to your destination. The driver must not enter data or program the unit unless the vehicle has come to a complete stop. Only a vehicle passenger should enter data or program the unit while the vehicle is moving.
- It is your responsibility to comply with all traffic laws.
- While every attempt is made to ensure that the database is accurate, roadways, points of interest, and business and service locations may change over time. The database does not include, analyse, process, consider or reflect any of the following: legal restrictions (such as vehicular type, weight, height, width, load and speed restrictions); road slope or gradient; bridge height, width, weight or other limits; population density; neighbourhood quality or safety; availability or proximity of law enforcement, emergency rescue, medical or other assistance; construction work zones or hazards; road or lane closures; road, traffic or traffic facilities safety or condition; weather conditions; pavement characteristics or conditions; special events; traffic congestion. It is your responsibility to disregard any unsafe, hazardous or illegal route suggestions.
- Protect the Magellan RoadMate from extreme temperature conditions. When the temperature has exceeded safe operating limits, the Magellan RoadMate will not turn on until the internal temperature is within operating limits. A warning will be displayed indicating that the operating temperature of the Magellan RoadMate is outside of these limits.

© 2004 Thales Navigation, Inc. All rights reserved.

Magellan, RoadMate, Turn it on and go, TrueView, QuickSpell and FlexAddress are trademarks of Thales Navigation.

No part of this user manual may be reproduced or transmitted in any form or by any means, electronically or mechanically, including photocopying and recording, for any purpose other than the purchaser's personal use, without the prior written permission of Thales Navigation.











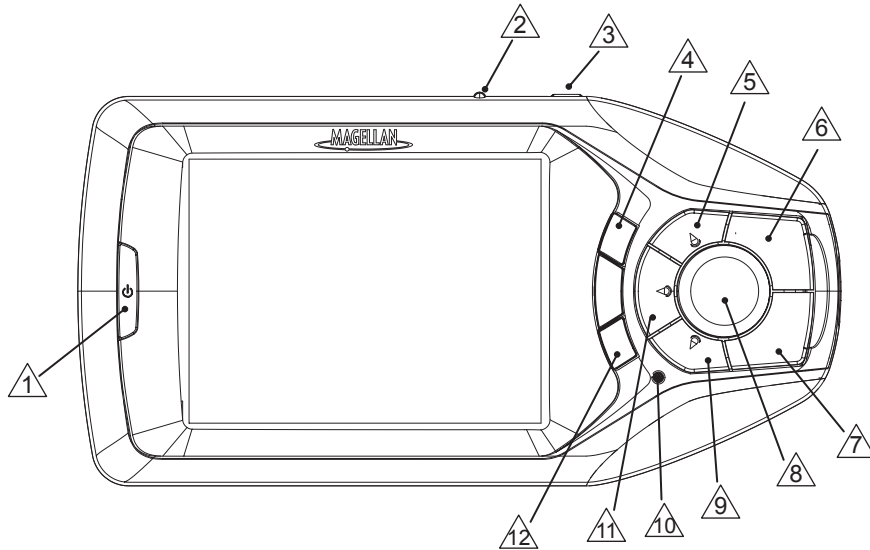



# Table of Contents

Magellan RoadMate .....	1
FRONT VIEW .....	1
REAR VIEW .....	2
Installing the Magellan RoadMate .....	3
Installation.....	3
Installation using the Windscreen Mount .....	3
Connecting to a Personal Computer .....	5
Basic Operations .....	6
Adjusting the Volume .....	6
Repeating the Last Command.....	6
Turning the Magellan RoadMate On .....	7
Turning the Magellan RoadMate Off .....	8
Inputting Text Characters .....	8
Additional Characters ("More" Button).....	9
Numerical Characters ("123" Button).....	9
Using QuickSpell®.....	9
Using FlexAddress™.....	11
Selecting a Destination .....	12
Selecting a Destination Using Street Address .....	12
Selecting a Destination Using Street Address - Select the Country .....	12
Selecting a Destination Using Street Address - Search by Town.....	13
Select a Destination - Search by Postcode.....	14
Selecting a Destination Using Street Address - Search By Area.....	16
Select a Destination - Search in Previous Towns .....	18
Selecting a Destination Using the Address Book .....	20
Selecting a Destination from a Previous Destination .....	20
Selecting a Destination from a Previous Destination and Saving it to the Address Book .....	21
Selecting a Destination from the Address Book.....	23
Saving a New Address to your Address Book and select it as your destination .....	24
Selecting a Point of Interest as a Destination.....	26
Selecting a Point of Interest as a Destination - Search by Name.....	26
Selecting a Point of Interest as a Destination - Choose by Category .....	27
Searching the POI Category using "Nearest" .....	28
Searching the POI Category using "List by Town" .....	29
Searching the POI Category using "All Areas" .....	30
Selecting a Junction as a Destination.....	31
Selecting your Destination on the Map.....	33
Choosing the Routing Method .....	34
Travelling to a Destination .....	35
Guidance Information Screens.....	35
Guidance Screen .....	36
Changing the Map Zoom Levels.....	36
List of Directions Screen .....	37
TrueView 3D Screen.....	38

Deviating from the Planned Route .....	38
Excluding a Manoeuvre in a Planned Route .....	39
Cancelling a Planned Route .....	40
Changing the Route Method .....	40
Displaying Your Location .....	42
Displaying Information About Your Present Location .....	42
User Options .....	43
User Option Choices .....	43
Using the Trip Computer .....	44
Viewing the Current Trip on the Trip Computer .....	44
Stopping or Starting the Trip Computer .....	44
Resetting the Trip Computer .....	45
Saving the Current Trip Report .....	45
Viewing a Saved Trip Report .....	45
Deleting a Trip Report .....	46
Configuring the Magellan RoadMate .....	47
Setting the Map Options .....	48
Setting the Map Colours .....	49
Setting the Route Preferences .....	50
Setting the Voice Options .....	51
Setting the Colour Options .....	52
Setting the Contrast .....	53
Setting the Brightness .....	54
Setting the Display Options .....	55
Setting the Tone Options .....	56
Selecting the Language .....	57
Performing Diagnostic Checks .....	58
Editing the User Name .....	59
Selecting the Points of Interest to Display on the Map .....	60
Using the Magellan RoadMate Tutorial .....	61
Moving around the Tutorial .....	61
Loading Addresses from your PDA or SmartPhone® .....	62

## FRONT VIEW



	On/Off Button	Press to turn the Magellan RoadMate on or off.
	Volume Control	Adjust to set the speaker volume.
	Repeat	Press to repeat the last spoken prompt.
	Zoom In Button	Whilst viewing the map, press to zoom in on the centre of the display.
	Option Button	Press to access the User Option menu.
	Enter Button	Press to confirm highlighted selections.
	Cancel Button	Press to stop the current function.
	8-Way Arrow Keypad	Press to move the cursor or to highlight other options.
	Locate Button	Press to display the current location details.
	Light Sensor	Automatically the contrast and brightness of the display to allow for changes in lighting.
	View Button	Press to view map display, list of directions, or TrueView® 3D display.
	Zoom Out Button	Whilst viewing the map, press to zoom out from the centre of the display.

## REAR VIEW

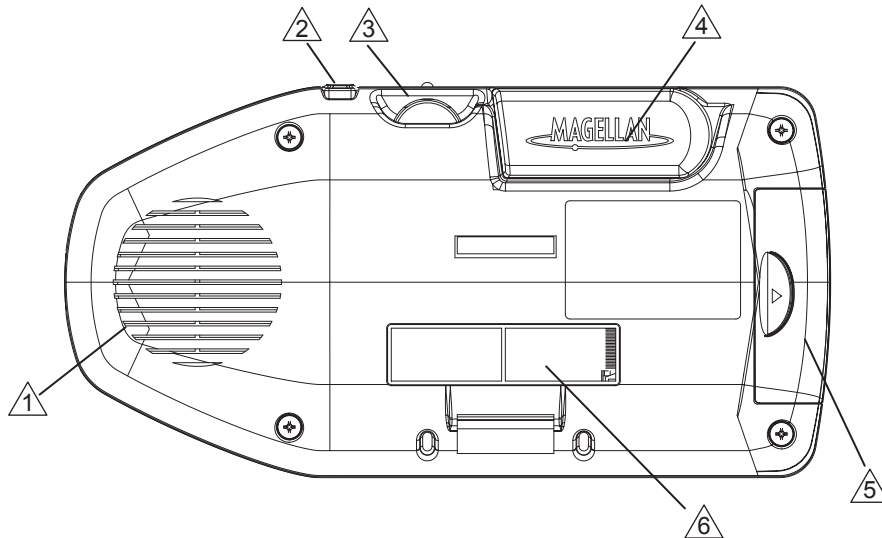

	Speaker	Used for spoken directions.
	Repeat Button	Press to repeat the last spoken prompt.
	Volume Control	Adjust to set the volume of the speaker.
	Detachable Antenna	Rotate upwards when in use to receive signals from the GPS satellite network.
	Compact Flash	Storage compartment for the CompactFlash memory card.
	Power/Data Connector	Connection for power and data for the Magellan RoadMate.

**Notepad**

The Magellan RoadMate has a touchscreen display and keypad giving you two easy ways to input information into your Magellan RoadMate. The examples in this manual describe how to use the 8-way arrow keypad and the Enter button to input and accept changes.

If you prefer to use the touchscreen, touch the key directly on the screen with your finger. Please use the method that is easiest for you.

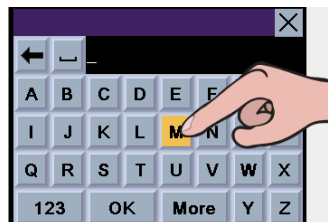



## Installation

Take care when mounting the Magellan RoadMate in your vehicle, whether using the windscreen mount, vent mount or other mount, that it does not obstruct the driver's view of the road. Make sure that the positioning of the Magellan RoadMate and cable does not interfere with the operation of vehicle safety devices, such as air bags. You assume the risks associated with damage to your vehicle or vehicle's occupants as a result of how you choose to mount the Magellan RoadMate.

### Installation using the Windscreen Mount

Attach the mounting plate to the cradle using the four supplied Phillips screws.



Slide the cradle and plate assembly onto the windscreen mounting bracket.



Attach the Magellan RoadMate to the cradle.



Clean the relevant area of the windscreen with the supplied alcohol swab.



# 4

## Installing the Magellan RoadMate

Press the windscreen mount to the glass and rotate the locking lever towards the glass.



Plug the power cable into the cradle. To do this simply connect the small end of the vehicle power cable to the power connector on the cradle (see the illustration below).

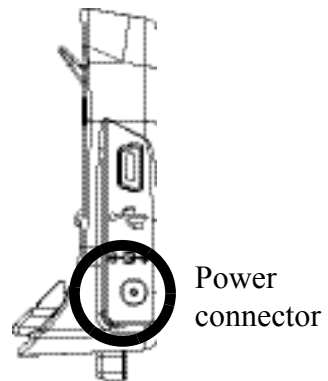

Plug the cigarette lighter connector into an appropriate 12V socket (cigarette lighter) in your car.



Rotate the antenna upwards.



Installation is complete and you are ready to turn the Magellan RoadMate on and go.

The standard cradle is equipped with ports for connecting the Magellan RoadMate to a personal computer and external power source. Connecting your Magellan RoadMate to your PC will allow you to download future software and map updates.

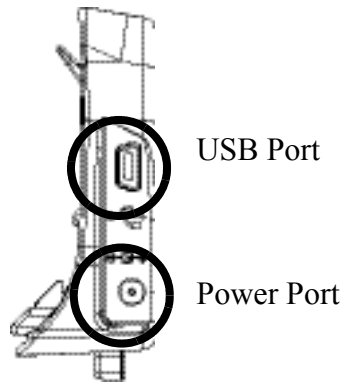

## **Connecting to external power**

When connecting to an external power source, leave the Magellan RoadMate attached to the cradle, disconnect the vehicle power cable and remove the assembly (Magellan RoadMate and its cradle) from the vehicle.

Connect the small end of the External Power Cable to the power port on the cradle and plug the other end of the cable into a standard socket.

## **Connecting to a personal computer**

When connecting to a personal computer, leave the Magellan RoadMate attached to the cradle, disconnect the vehicle power cable and remove the assembly (Magellan RoadMate and its cradle) from the vehicle.

Connect the small end of the USB Cable to the USB port on the cradle and the large end to an available USB port on your personal computer.

### Adjusting the Volume

The volume control is located on the top of the Magellan RoadMate. Use the thumbwheel to set the speaker volume to the desired level.

Volume Control

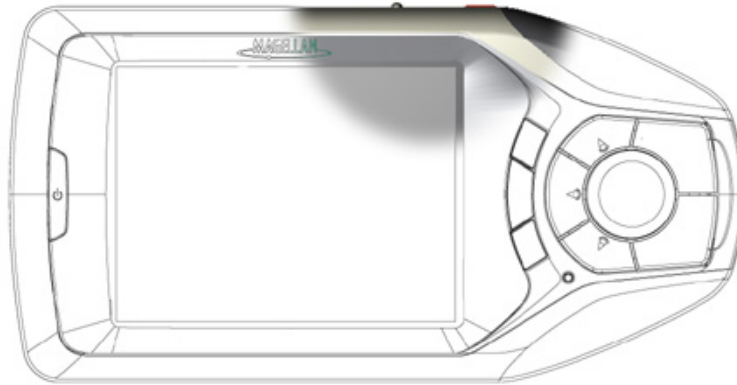

### Repeating the Last Command

If you missed the last voice command you can repeat it by pressing the Repeat button. The Repeat button is located on the top of the Magellan RoadMate.

Repeat Button

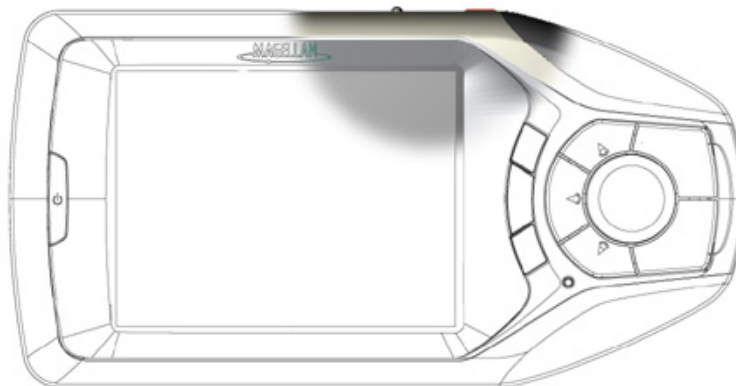

## Turning the Magellan RoadMate On

Press the Power button.

If power is properly connected, a logo screen will be displayed followed by the Warning screen.



Select the User profile to be applied and press Enter.

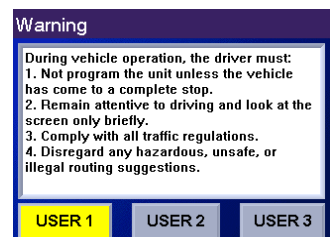

## Notepad



The Magellan RoadMate can be personalised for three different users. The Magellan RoadMate will use the saved profile settings for the user who you select here. Please refer to the User Options section of this manual for information about how to change the name of the 3 different user profiles that are available in your Magellan RoadMate.

Either the Destination screen or the Resume Guidance screen will be automatically displayed.

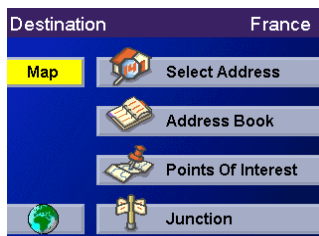

Select Destination

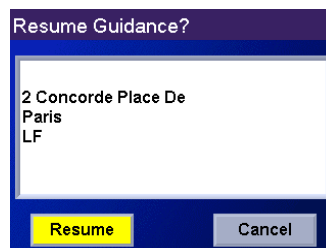

Resume Guidance

The Resume Guidance screen is displayed if you were navigating towards a destination when the Magellan RoadMate was turned off.

### Turning the Magellan RoadMate Off

Press the Power button and the Magellan RoadMate will switch itself off.

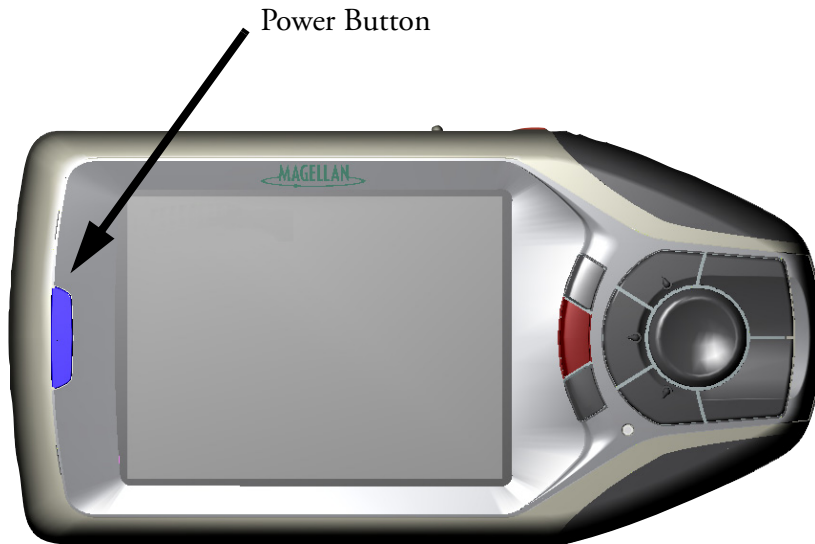

### Inputting Text Characters

Whenever you need to input names, street addresses, etc., the Magellan RoadMate will display a keyboard that allows you to use the 8-way arrow keypad and the Enter key to highlight and select the alphanumeric characters. You can also simply touch the screen to select the required letter.

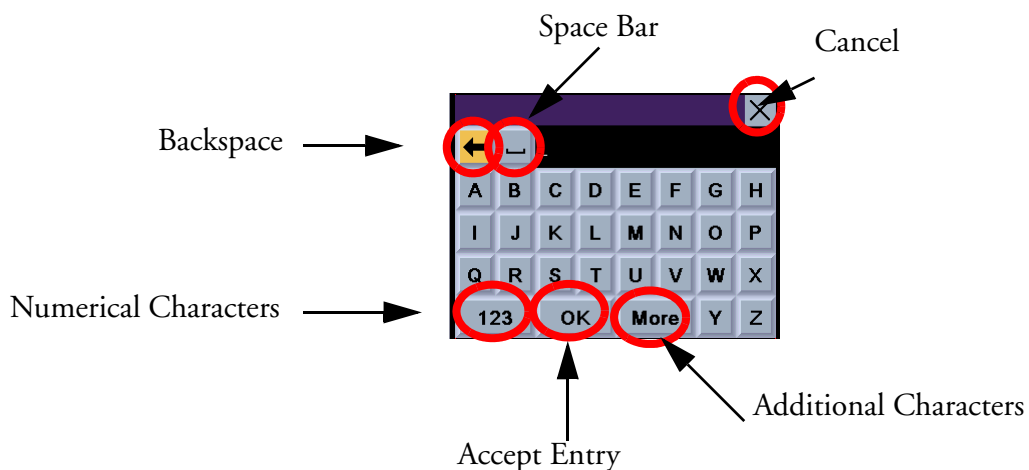

## Additional Characters ("More" Button)

When you are entering characters you may need to add hyphens or other special or accented characters. When available, pressing the "More" button brings up an additional keypad with the characters shown here.

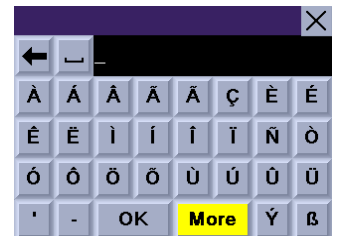

## Numerical Characters ("123" Button)

When available, pressing the "123" button brings up a keypad with the numeric characters. Numerical characters can be selected in the same way as alphabetic characters.

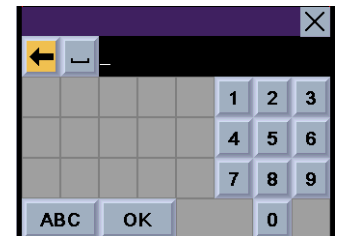

## Using QuickSpell®



### What Is QuickSpell?

The Magellan RoadMate uses QuickSpell technology to provide you with the fastest possible method of entering characters. QuickSpell eliminates the possibility of a misspelled word or looking for a town or street that is not in the map database. As you begin entering characters, the QuickSpell feature of the Magellan RoadMate greys out those characters which are not available, thereby speeding up the data entry process.

Example:

Suppose that you need to input the name of a town, in this case, PARIS.

Select "P" using the 8-way arrow keypad and press Enter.



Select "A" using the 8-way arrow keypad and press Enter.

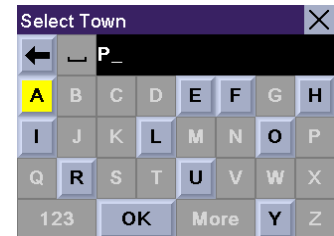

Select "R" using the 8-way arrow keypad and press Enter.

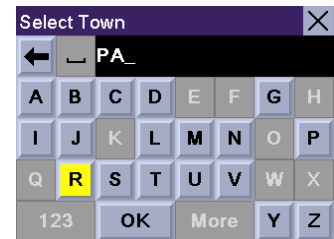

When you feel that enough characters have been entered so that the list of towns is short enough to find PARIS in the list, select "OK" using the 8-way arrow keypad and press Enter.

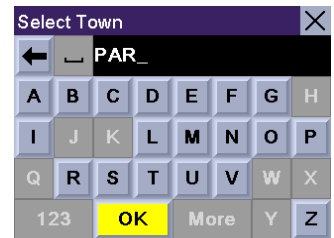

Use the 8-way arrow keypad to select "PARIS" from the list and press Enter. (If you are using the touchscreen to select the town, use the scroll bar to the right of the list to scroll the list up and down.)

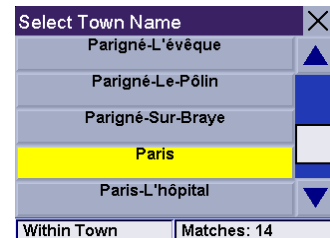

If the list is still too long press Cancel to return to the keyboard to continue entering characters. The list of items found in the database is limited to 100 items. When over 100 items have been found, "Matches>100" will be displayed in the bottom right corner of the display and you may need to press Cancel and enter additional characters.



## Using FlexAddress™



### What is FlexAddress?

FlexAddress is a very powerful feature which allows you to search for an address by typing any significant word in its name.

Example:

Suppose you want to go to Place Charles de Gaulle in Paris. Either enter 'CHARLES' to be presented with a list of all places containing Charles in their names and pick 'Place Charles de Gaulle' from the list...

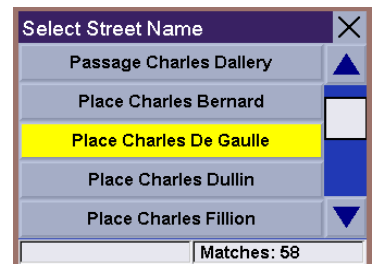

...or enter 'GAU' and press OK to be presented with a list of all places beginning with these three letters.

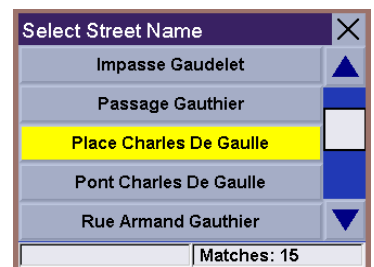

Both methods allow you to quickly select the same destination!

### Selecting a Destination Using Street Address

When the address that you want to go to is not stored in your address book or your Previous Destinations list, select your destination by entering the street address.

Your Magellan RoadMate uses one address database for each European country. The first step in searching for a new address is to check that the correct country is selected. Once the correct country is selected four search options are available:

- use "Search by Town" to enter the name of the town that the address can be found in.
- use "Search by Postcode" when you do not know, or are unsure of, the town name but you do know the postcode for the address. You will be given a list of all towns matching the postcode you entered.
- use "Search by Area" when you do not know, or are unsure of, the town name but you do know which area it is in. You will be given a listing of all the towns for the area you entered which have the street name you are looking for. Please note that the type of area depends of the country currently selected (County in England, Département in France, Kreis in Germany, etc.).
- use "Previous Towns" to select the town that the address can be found in from a list of towns you previously searched.

#### Selecting a Destination Using Street Address - Select the Country

From the Destination screen, check in the title bar that the appropriate country is selected. In our example we are looking for an address in Paris, France.

To select the required country select the Earth icon and press Enter to display the list of all countries in your map database. Use the 8-way arrow keypad to scroll the list up and down. When you see the name of the country you are looking for, select it and press Enter.

France is now displayed in the screen title bar.

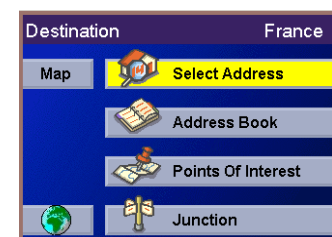
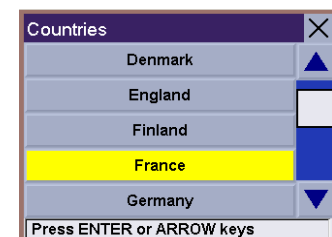
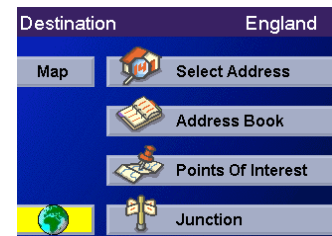

## Selecting a Destination Using Street Address - Search by Town

From the Destination screen, check in the title bar that the correct country is selected (if not, select the Earth icon and choose it from the list) then highlight the "Select Address" option and press Enter.

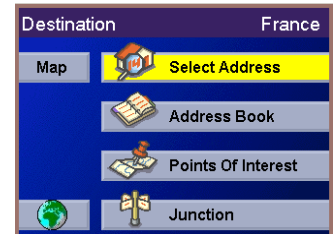

Select "Search By Town" and press Enter.



Use the 8-way arrow keypad to enter the first few characters in the town name. After you have selected these first few characters, select "OK" and press Enter to display the list of all matching towns.

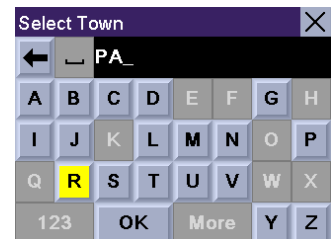

Remember, if the list is too long, press Cancel while viewing the list to return to this screen and continue to input characters.

Use the 8-way arrow keypad to scroll the list up and down. When you see the name of the town you are looking for, select it and press Enter.

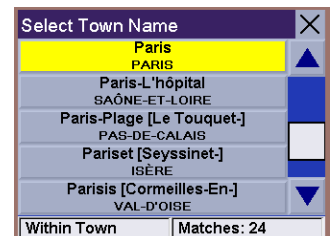

Use the 8-way arrow keypad to enter the first few characters of the street name. After you have selected the characters, select "OK" and press Enter. If you wish, you may enter the entire street name. Remember that FlexAddress allows you to enter any significant word in the name of the street.

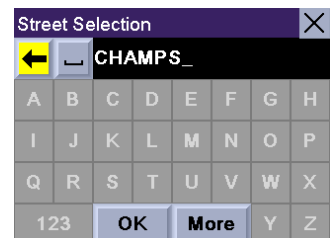

Use the 8-way arrow keypad to scroll the list up and down. When you find the street name, select it and press Enter.

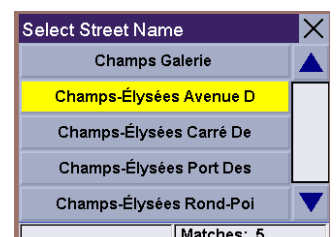

Use the 8-way arrow keypad to enter the street address. The acceptable range of numbers is displayed at the top of the screen. Once an acceptable street address has been entered, the "Done" button will become active. Select "Done" and press Enter when you are ready to continue.



Select the desired Routing Method and press Enter.

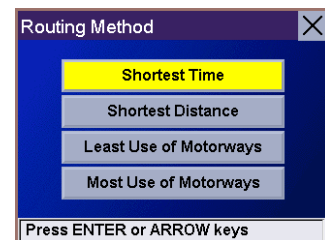

The Magellan RoadMate will calculate the route. When the calculations are complete, the Guidance screen will be displayed.

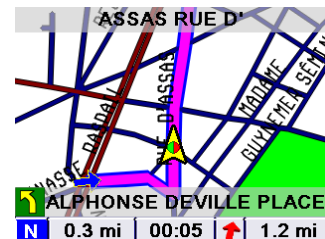

### Select a Destination - Search by Postcode

From the Destination screen check that the correct country is selected (if not, select the Earth icon and choose it from the list) then highlight the "Select Address" option and press Enter.

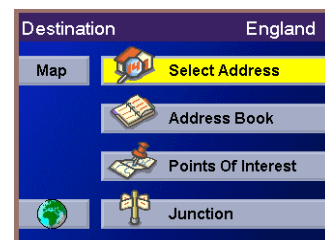

Select "Search By Postcode" and press Enter.

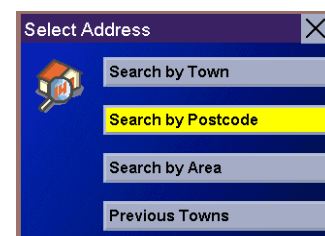

# Selecting a Destination

# 15

On the Spell Postcode screen enter the full or partial postcode for the street address which you are searching for. Select the 'ABC' button and press Enter if you need to enter letters in the postcode or the '123' button to enter numbers. Once the postcode is entered, select OK and press Enter.

Select the town from the list of towns displayed (these are all the towns which match the postcode you entered) and press Enter.

Use the 8-way arrow keypad to enter the first few characters for the street name. After you have selected the characters, select "OK" and press Enter. If you wish, you may enter the entire street name. Remember that FlexAddress allows you to enter any significant word in the street name.

Use the 8-way arrow keypad to scroll the list up and down. When you find the street name, select it and press Enter.

Use the 8-way arrow keypad to enter the street address. The acceptable range of numbers is displayed at the top of the screen. Once an acceptable street address has been entered, the "Done" button will become active. Select "Done" and press Enter when you are ready to continue.

Select the desired Routing Method and press Enter.

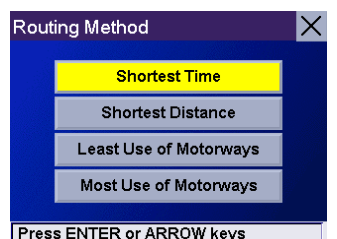
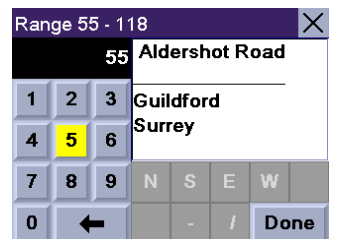
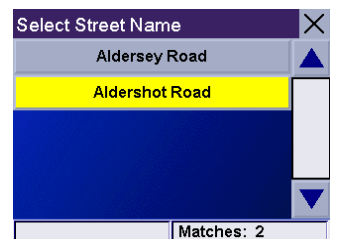
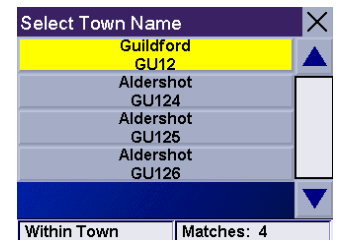
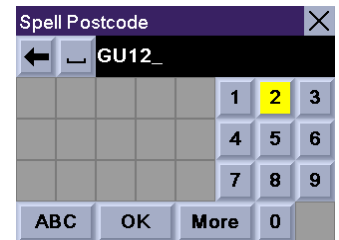

The Magellan RoadMate will calculate the route. When the calculations are complete, the Guidance screen will be displayed.

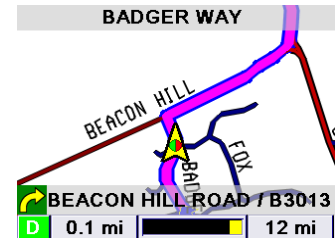

### Selecting a Destination Using Street Address - Search By Area

From the Destination screen check that the correct country is selected (if not, select the Earth icon and choose it from the list) then highlight the "Select Address" option and press Enter.

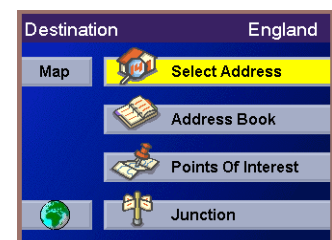

Select "Search By Area" and press Enter. Note that the name of this option changes depending of the currently selected country, e.g. If England is the selected country, the option is named "Search by County".

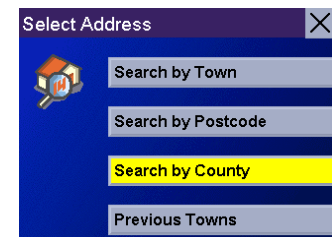

Use the 8-way arrow keypad to enter the first few characters of the area. Select "OK" and press Enter.

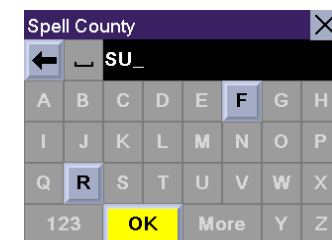

Use the 8-way arrow keypad to select the county and press Enter.

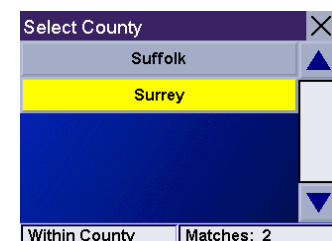

# Selecting a Destination

17

Use the 8-way arrow keypad to enter the first few characters for the street name. Remember that FlexAddress allows you to enter any significant word in the street name. Select "OK" and press Enter.



Select "OK" and press Enter. Select the street name from the list and press Enter.

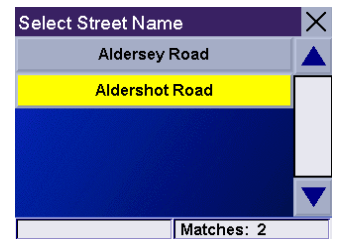

Select the town from the list of displayed towns. (These are all the towns in the selected county which have the street name you selected.) Press Enter.

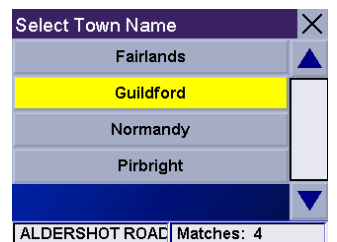

Use the 8-way arrow keypad to enter the street address. The acceptable range of numbers is displayed at the top of the screen. Once an acceptable street address has been entered, the "Done" button will become active. Select "Done" and press Enter when you are ready to continue.

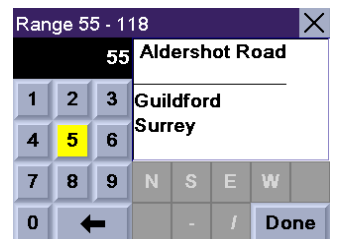

Select the desired Routing Method and press Enter.

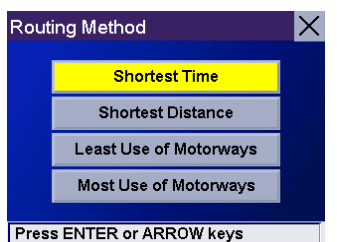

The Magellan RoadMate will calculate the route. When the calculations are complete, the Guidance screen will be displayed.



**Select a Destination - Search in Previous Towns**

From the Destination screen highlight the "Select Address" option and press Enter.

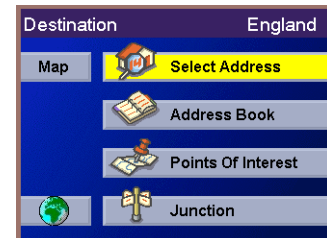

Select "Previous Towns" and press Enter.

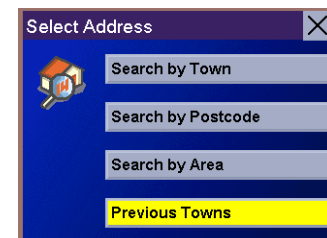

Select the town from the list of towns displayed (these are all the towns you previously searched, in chronological order) and press Enter.

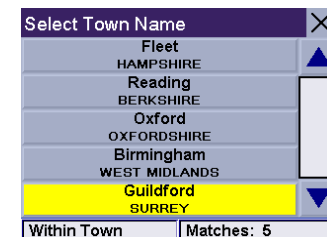

Use the 8-way arrow keypad to enter the first few characters of the street name. After you have selected the characters, select "OK" and press Enter. If you wish, you may enter the entire street name. Remember that FlexAddress allows you to enter any significant word in the street name.



Use the 8-way arrow keypad to scroll the list up and down. When you find the street name, select it and press Enter.

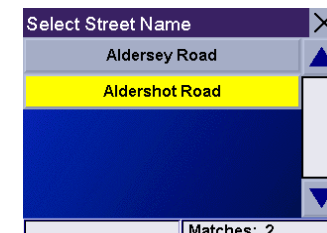

Use the 8-way arrow keypad to enter the street address. The acceptable range of numbers is displayed at the top of the screen. Once an acceptable street address has been entered, the "Done" button will become active. Select "Done" and press Enter when you are ready to continue.

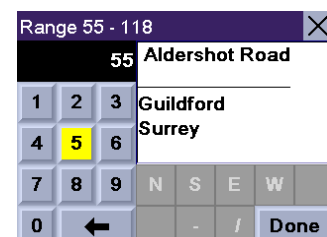



Select the desired Routing Method and press Enter.

The Magellan RoadMate will calculate the route. When the calculations are complete, the Guidance screen will be displayed.

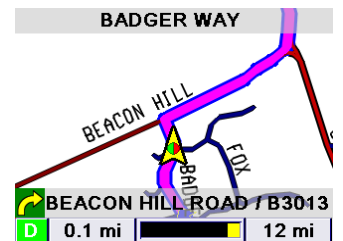
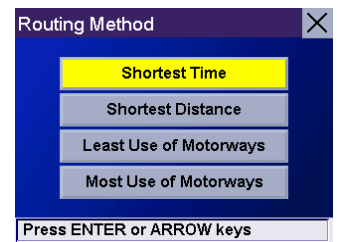

### Selecting a Destination Using the Address Book

The Address Book can store up to 100 addresses for each of the three users. When you select "Address Book" you will be presented with three options. Selecting "Previous Destinations" lets you select from a list of the last 20 destinations you have visited. You may also save an address from the Previous Destination list to your address book. "List Addresses" displays a list of all the addresses you have in your address book. "Create New Entry" lets you create a new address and put it in your address book before setting it as your destination.

#### Selecting a Destination from a Previous Destination

From the Destination screen, select "Address Book" and press Enter.

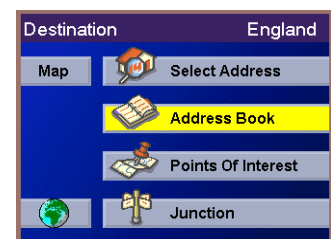

Select "Previous Destinations" and press Enter.

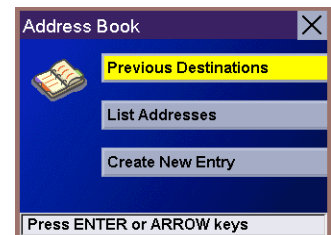

Select from the list of previous destinations and press Enter.



Select the "Route" button and press Enter.

(Note: You can select the "Edit" button if you want to edit the displayed address and save it to your Address Book.)

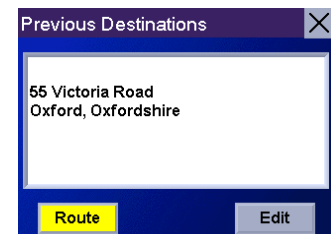

Select the desired Routing Method and press Enter.

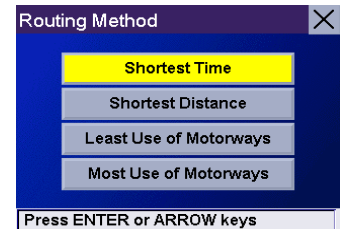

The Magellan RoadMate will calculate the route. When the calculations are complete, the Guidance screen will be displayed.

## Selecting a Destination from a Previous Destination and Saving it to the Address Book

From the Destination screen, select "Address Book" and press Enter.

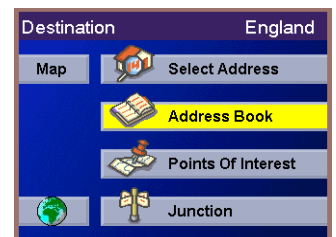

Select "Previous Destinations" and press Enter.

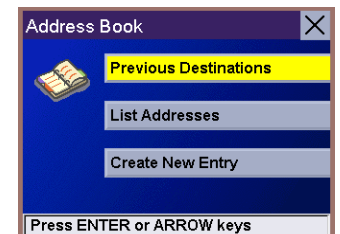

Select from the list of previous destinations and press Enter.



To save this destination to the Address Book, select the "Edit" button and press Enter.

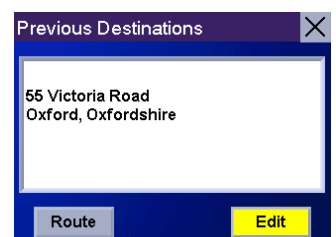

The top line (Name) and the bottom line (Information) can be edited. The address cannot be changed. Use the 8-way arrow keypad to select the line you want to modify. When you have selected the line, press Enter.

Use the 8-way arrow keypad to enter the desired text. When complete, select "OK" and press Enter.

When the Address Book entry is as desired, select the "Save" button and press Enter.

The address is saved to the Address Book. The Previous Destination screen is displayed to continue the routing to the previous destination. Select the "Route" button and press Enter.

Select the desired Routing Method and press Enter. The route will be calculated and the Guidance screen will be displayed.

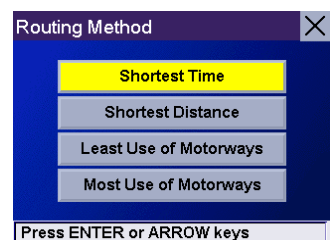
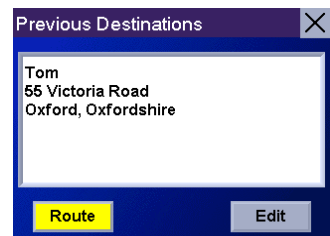
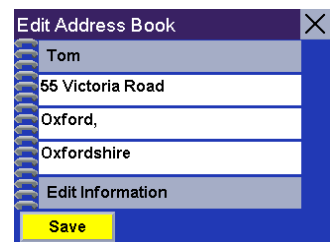
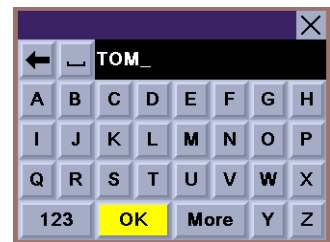
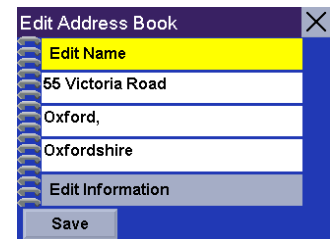

## Selecting a Destination from the Address Book

From the Destination screen, select "Address Book" and press Enter.

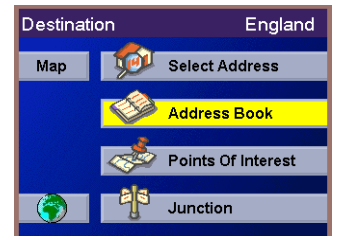

Select "List Addresses" and press Enter.

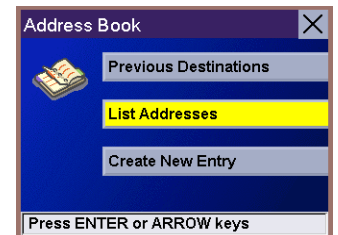

Select the destination from the list of addresses in the Address Book and press Enter.

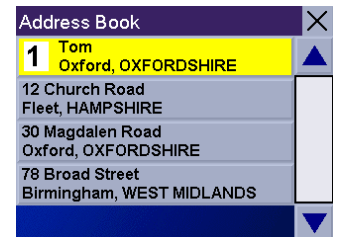

Select the "Route" button and press Enter.

(Note: before continuing, the address information can be edited and saved to the Address Book or the address can be deleted from the Address Book.)

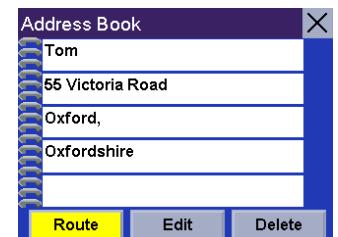

Select the desired Routing Method and press Enter. The route will be calculated and the Guidance screen will be displayed.

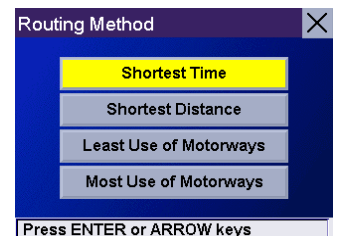

### Saving a New Address to your Address Book and select it as your destination

From the Destination screen, select "Address Book" and press Enter.

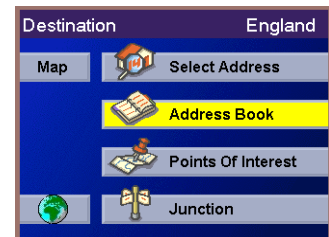

Select "Create New Entry" and press Enter.

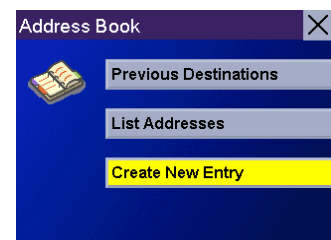

Select "Search By Town", "Search by Postcode", "Search by Area" or "Previous Towns" and press Enter.

(Note: for more information about searching for an address, please refer to the "Selecting a Destination using Street Address" section in this manual.)

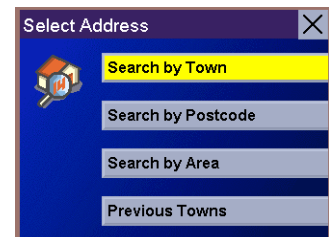

Once your address is selected, the Edit Address Book screen will be displayed. From this screen you can choose to Edit the Name and Information and to set a priority for this address.

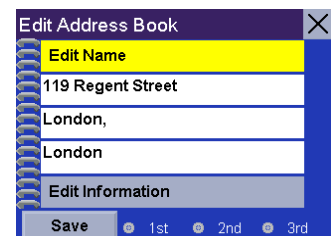

Select the Edit Name option to display the keypad screen. Enter a name for this address and select "OK". The address will be stored to the address book under this name.

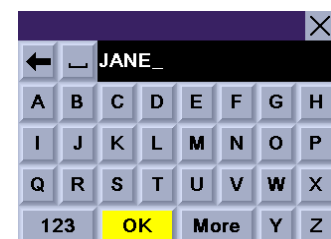

Select the Edit Information option to display and edit any additional information related to this address and select "OK".

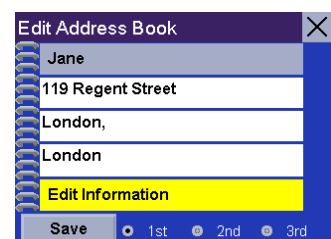

You can now set a priority for this address. Select "1st", "2nd" or "3rd" to set the rank of this address in your Address Book. All addresses with a 1st priority will be displayed at the top of the list, followed by 2nd and 3rd. This priority supersedes the alphabetical order.

Select "Save" and press Enter to save this address to your address book.

Select the 'List Addresses' option from the Book Screen.

Scroll up and down the list to pick the address you want to set as your destination and press Enter.

Select the desired Routing Method and press Enter. The route will be calculated and the Guidance screen will be displayed.

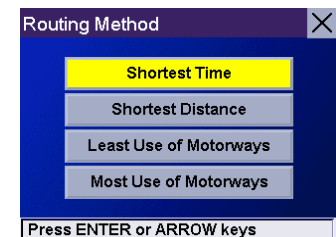
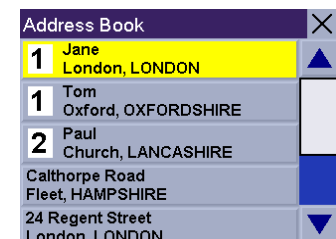
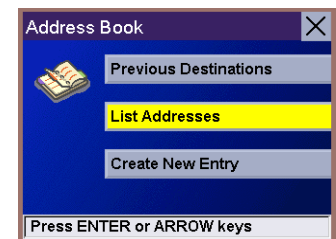
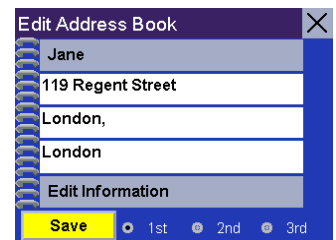
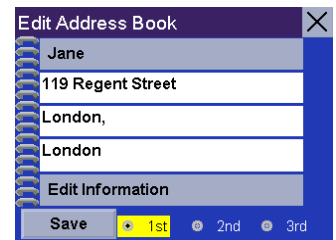

### Selecting a Point of Interest as a Destination

Points of Interest (commonly referred to as POIs), are locations of commercial, recreation landmarks or services that are preloaded into the Magellan RoadMate. These range from restaurants, parks, petrol stations and banks to schools and police stations. The purpose of the POI database (accessed through the "Points of Interests" menu option) is to provide you with a list of popular destinations that you might be interested in visiting, without having to add them to your address book manually. These POIs are very useful when you are travelling through an unfamiliar area. You can search for a POI by name or by category.

### Notepad

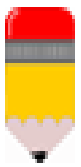

Your Magellan RoadMate uses one Points of Interests database for each European country. The first step in searching for a new POI is to check that the correct country is selected.

#### Selecting a Point of Interest as a Destination - Search by Name

Check in the title bar of the Destination screen that the correct country is selected. Select "Points of Interests" and press Enter.

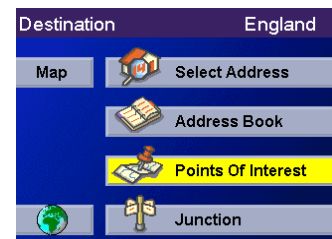

Select "Spell Name" and press Enter.

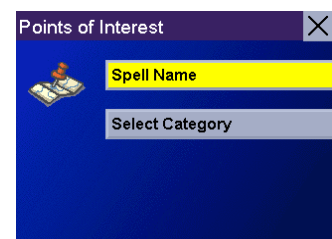

Use the keypad to enter the name of the point of interest (you do not need to enter the entire name). Select OK and press Enter.

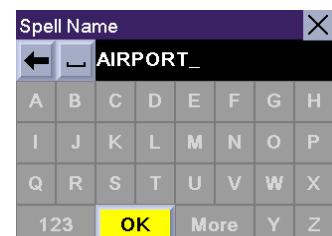



Use the 8-way arrow keypad to scroll through the list and select the desired point of interest from the list. This list can be very long as all points of interest beginning with the text entered are displayed. To shorten the list, press Cancel to go back to the keypad screen in order to input additional characters. Details for the selected POI are displayed in the upper part of the screen. Select your desired POI and press Enter to select it as your destination.

Select your desired Routing Method and press Enter. The route will be calculated and the Guidance screen will be displayed.

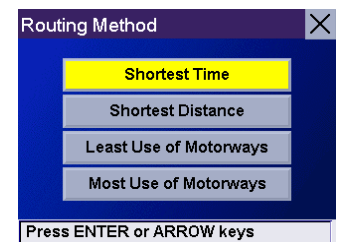
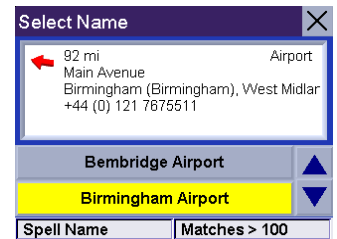

## Selecting a Point of Interest as a Destination - Choose by Category

Check in the title bar of the Destination screen that the correct country is selected. Select "Points of Interests" and press Enter.

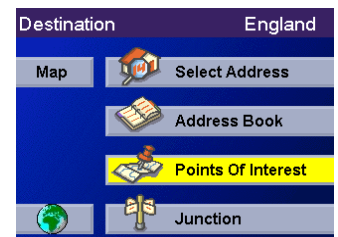

Select "Select Category" and press Enter.

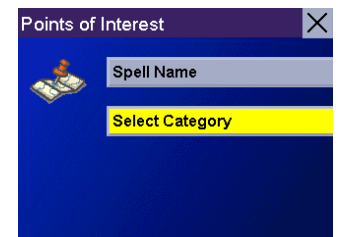

The list of POI categories is displayed. Scroll through this list to find the category you are interested in and press Enter.



There are three methods for searching the POI category you selected.

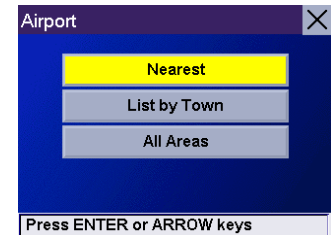

### Searching the POI Category using "Nearest"

Select the Nearest option to search for the POIs that are closest to your current location.

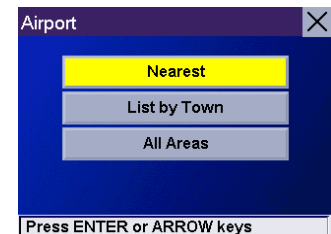

To see all of the POIs in the category that are nearest to your position, select "OK" and press Enter with no text entered.

To narrow the list down, use the 8-way arrow keypad to enter the first few characters for the POI you are looking for. Select "OK" and press Enter.

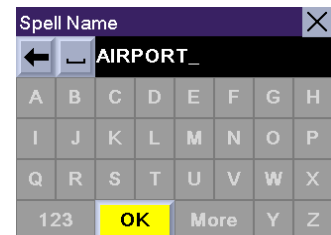

Select the POI from the list.

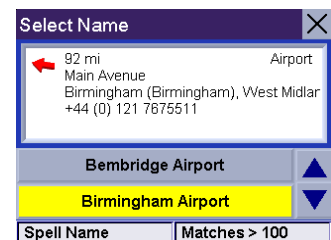

Select the desired Routing Method and press Enter. The route will be calculated and the Guidance screen will be displayed with all of the necessary guidance information.

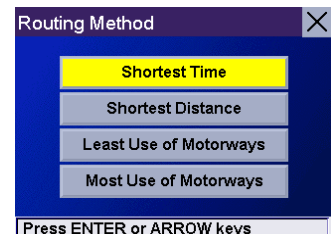

## Searching the POI Category using "List by Town"

Select the "List by Town" option to search for the POIs in the category selected for a specific town.

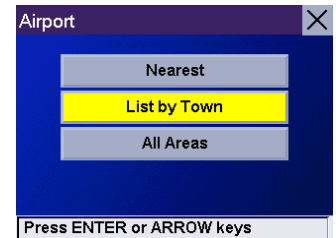

Use the keypad to enter the first few characters of the town where the POIs will be looked for. Select "OK" and press Enter.

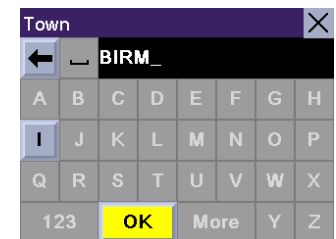

Select the town from the list.



Select the POI for the chosen category that is located in the town you selected from the list.

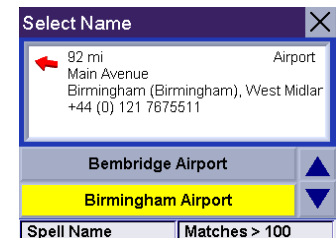

Select the desired Routing Method and press Enter. The route will be calculated and the Guidance screen will be displayed with all of the necessary guidance information.

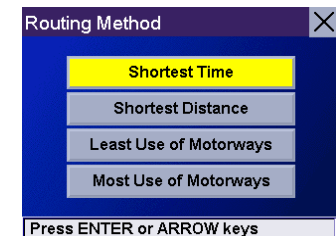

### Searching the POI Category using "All Areas"

Select the "All Areas" option to search for all POIs in the selected category (i.e. in the whole database for the currently selected country.)

Use the keypad to enter the first few characters of the POI you are looking for. Select "OK" and press Enter.

To see all of the POIs in the selected category, select "OK" and press Enter with no text entered.

Select the POI from the list.

Select the desired Routing Method and press Enter.

The route will be calculated and the Guidance screen will be displayed with all of the necessary guidance information.

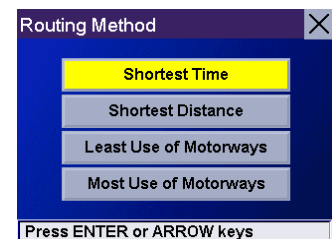
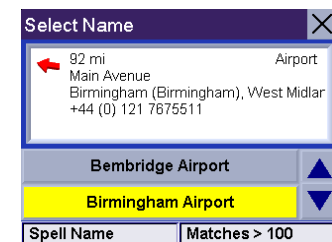

## Selecting a Junction as a Destination

You can set the junction between two streets as your trip destination.

From the Destination screen, check that the correct country is selected then select the Junction option and press Enter.

Select "Search By Town", "Search by Postcode", "Search by Area" or "Previous Towns" and press Enter.

(Note: for more information about searching for an address, please refer to the "Selecting a Destination using Street Address" section in this manual.)

Select one of the streets in the junction you are looking for.

Select the second street in the junction you are looking for. You can either enter the partial or full name of the street or select 'OK' and press Enter without entering any text to display the list of all streets that form a junction with the one you previously selected.

Select the second street from the list.

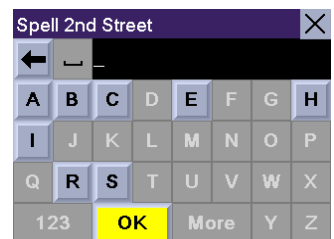
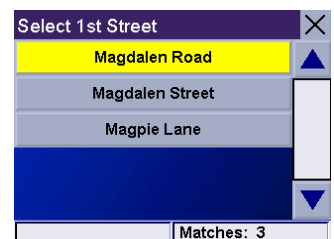
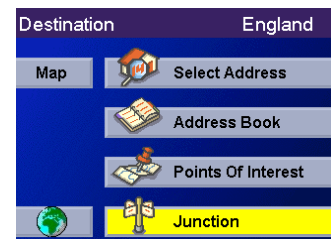

Select the desired Routing Method and press Enter.

The route will be calculated and the Guidance screen will be displayed with all of the necessary guidance information.

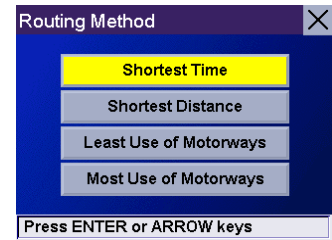

## Selecting your Destination on the Map

You can set your destination by pointing to it on the map.

From the Destination screen, select the Map option and press Enter. You can use the + and - keys to zoom in and out from the map.

Move the cursor around the map using the 8 ways arrow pad and point to your destination. You can point to a street name or a point of interest. Press Enter when the name of the required destination is displayed beside the cursor.

Note: check the User Options section in this User Manual for information about how to display POI icons on the map.

The Route to This Address screen displays information about the street or POI which you selected on the map. Select the Save button and press Enter to save this address in your address book or select the Route button and press Enter to calculate your route to this destination.

Select the desired Routing Method and press Enter. The route will be calculated and the Guidance screen will be displayed with all of the necessary guidance information.

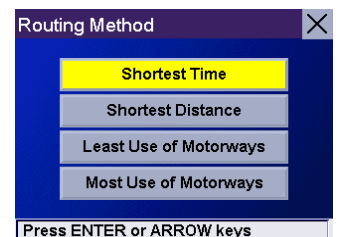
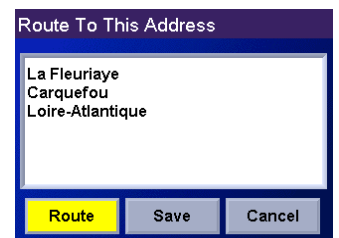
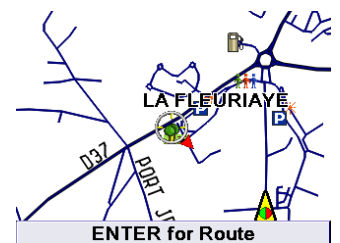
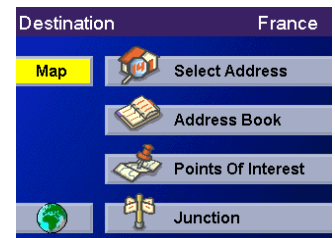

### Choosing the Routing Method

Every route calculation is based on the selected Routing Method criteria. Every time a new destination is selected, the Magellan RoadMate prompts you for the method that will be used to calculate the route.

**Shortest Time:** This selection calculates a route that should take the least amount of time taking into account speed limits and other information in the database. Other factors, such as traffic conditions, cannot be used in the calculation of shortest time.

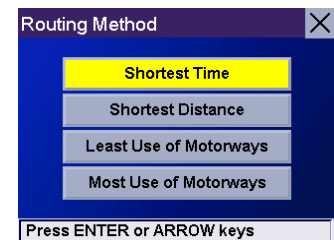

**Shortest Distance:** This option calculates the route using the most direct route to the destination. This route may not be the fastest due to lower speed limits, numerous traffic lights or other factors.

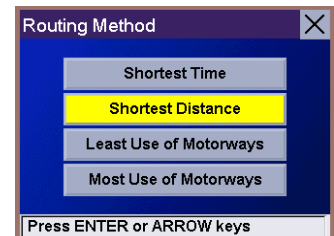

**Least Use of Motorways:** This selection calculates the route avoiding motorways whenever possible.

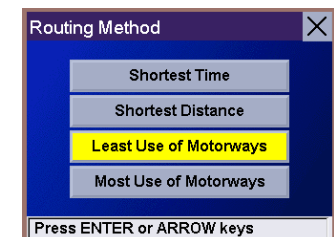

**Most Use of Motorways:** This selection calculates the route using motorways whenever possible.

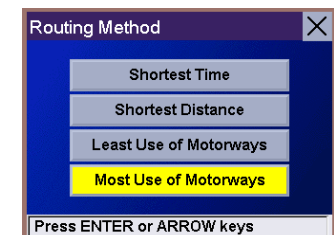



## Guidance Information Screens

The Magellan RoadMate has three screens which you can use to assist you in travelling to your destination: the Guidance screen, the List of Directions screen and the TrueView 3D screen.

**Guidance:** When a new destination is selected and calculated, the Guidance screen will be displayed. This screen displays a map of your surrounding area along with the planned route and information about the route. This screen can also be accessed when you have no route by selecting the "Map" button or by pressing the View button when you are viewing the Destination screen. It can also be selected by pressing the View button when you are viewing the TrueView 3D screen.

**List of Directions:** This screen is available only when you are travelling to a destination. This screen displays a list of the changes in direction (also known as manoeuvres) you will need to follow to arrive at the destination. It can also be used to exclude a manoeuvre and re-route you to your destination. To access the List of Directions screen, press the View button while viewing the Guidance screen.

**TrueView 3D:** This screen displays the next manoeuvre as a 3D graphic. It will help you know which lane to be in and provides you with an easy to follow picture of the next manoeuvre. To access the TrueView 3D screen, press the View button while viewing the Manoeuvre List.

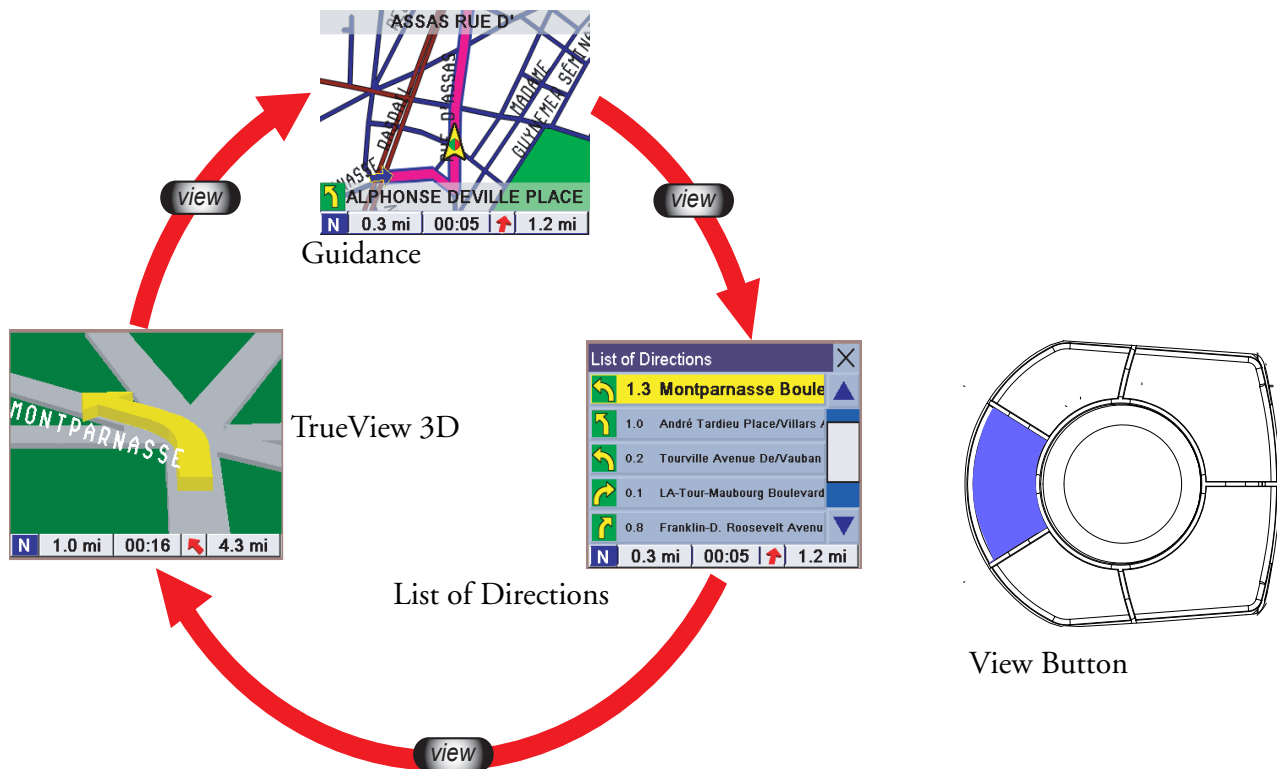

### Guidance Screen

The Guidance screen is the most commonly used screen in the Magellan RoadMate and provides you with detailed information about where you are and where you are going.

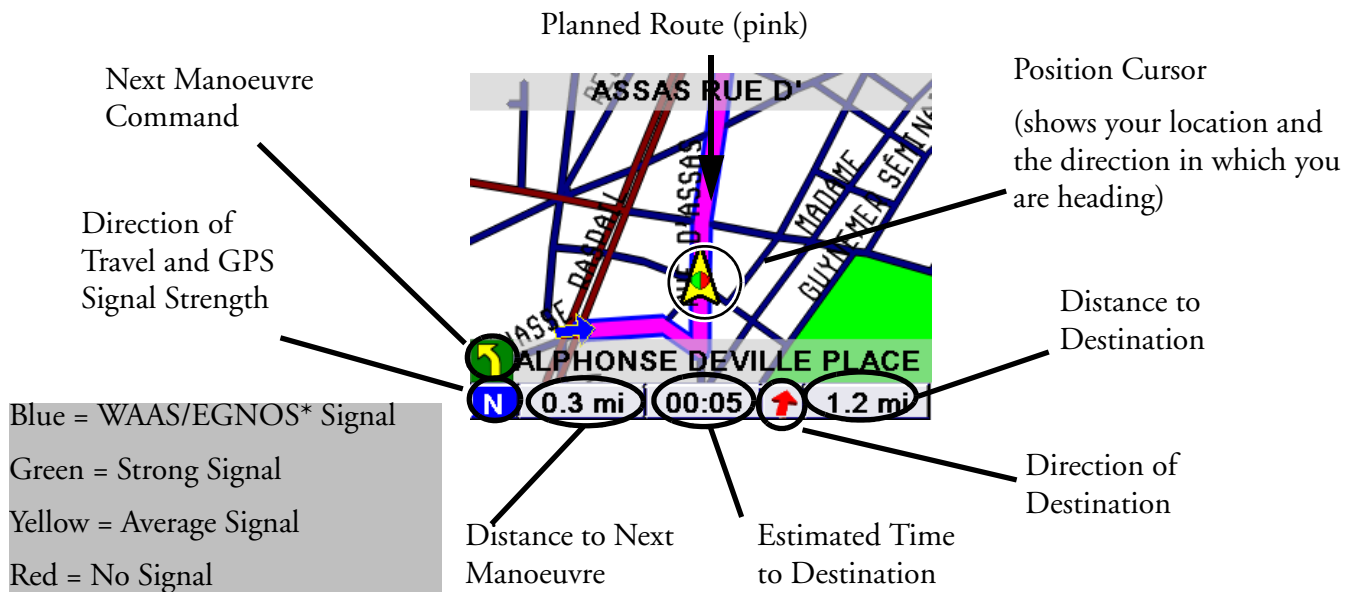

\* WAAS and EGNOS are two satellite networks, similar to the GPS satellite network, that provide increased accuracy for the Magellan RoadMate.

As you travel, the Guidance screen constantly updates your location and provides you with not only a map, but also a visual indication of where you are on the map.

### Changing the Map Zoom Levels

You can zoom in by pressing the "+" button or zoom out by pressing the "-" button.

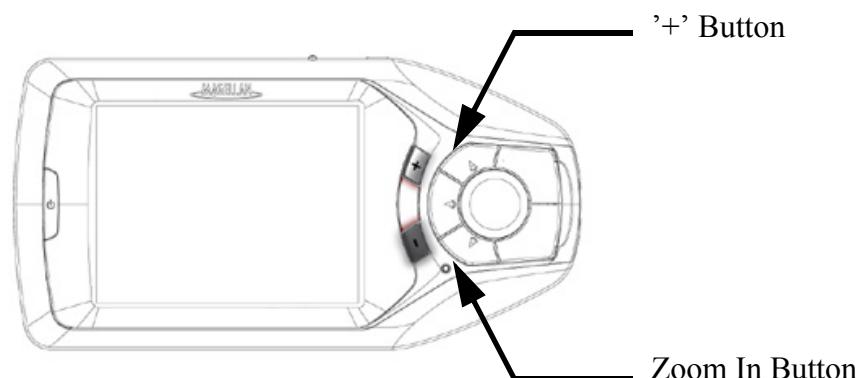

## Notepad



If the Magellan RoadMate loses the satellite signal for more than 15 seconds and is unable to compute your location, the display will automatically switch to the TrueView 3D display. This will give you the information needed for your next manoeuvre.

## List of Directions Screen

The screenshot shows a 'List of Directions' window with a list of routes. The first route is highlighted in yellow: '1.3 Montparnasse Boule'. Below the list, there is a status bar with several indicators: a blue circle with 'N', '0.3 mi', '00:05', a red arrow pointing up, and '1.2 mi'. Callouts point to these elements with the following labels:

- Direction of Travel and GPS Signal Strength (points to the 'N' indicator)
- Distance to Next Manoeuvre (points to '0.3 mi')
- Estimated Time to Destination (points to '00:05')
- Direction of Destination (points to the red arrow)
- Distance to Destination (points to '1.2 mi')

Distance	Manoeuvre	Estimated Time	Direction	Distance to Destination
1.3	Montparnasse Boule			
1.0	André Tardieu Place/Villars			
0.2	Tourville Avenue De/Vauban			
0.1	LA-Tour-Maubourg Boulevard			
0.8	Franklin-D. Roosevelt Avenue			

## TrueView 3D Screen

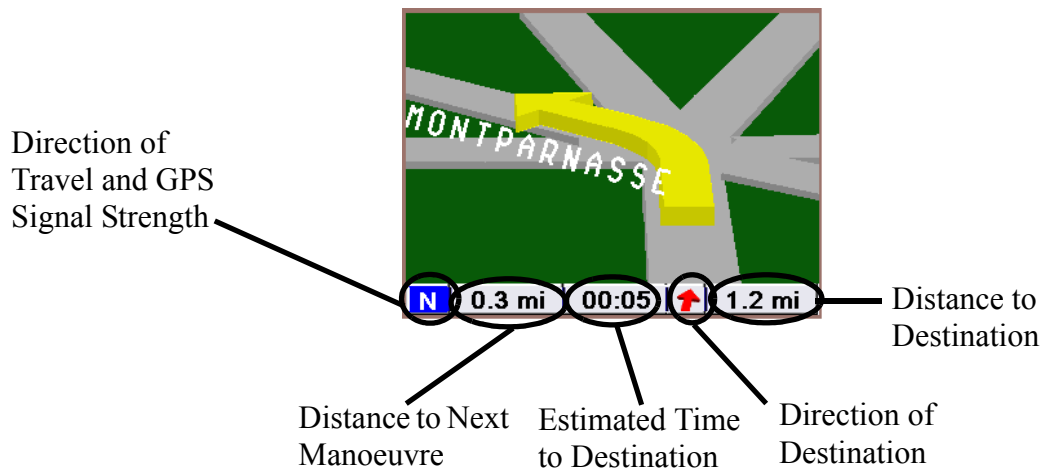

## Deviating from the Planned Route

If you deviate from the planned route, the Magellan RoadMate will get you back on course in one of two ways.

1. If you deviated from the planned route and switched off the Magellan RoadMate: Suppose you deviated from the planned route to stop at a shop for a moment or to drop something off at a friend's house. In this case you would normally come to a complete standstill and turn off your vehicle's ignition, which also switches off the Magellan RoadMate. After you have completed your errand and turned your vehicle's ignition back on (which switches the Magellan RoadMate back on), you would be presented with a screen asking if you wanted to resume your route.

Selecting "Resume" causes the Magellan RoadMate to recalculate the route using the same destination as before.

Selecting "Cancel" clears the route and displays the Destination screen.

2. If you deviated from the planned route and kept driving: Suppose you deviated from the planned route due to a traffic jam or you just wanted to do a little sightseeing. The Magellan RoadMate will automatically guide you back to your route. After recalculating, the Magellan RoadMate will provide you with directions to route you back to your original destination.

## Notepad



The Magellan RoadMate will attempt to return you to your route three times. If after the third attempt, you are still not back on your route, it assumes that you no longer plan to go to your original destination and will clear the route. Please see the User Options section of this user manual for information about how to switch off the automatic rerouting.

## Excluding a Manoeuvre in a Planned Route

While travelling or setting up your destination you may find it necessary to exclude one of the manoeuvres in the List of Directions. This could be due to an accident or street maintenance you want to avoid. The Magellan RoadMate allows you to select a specific manoeuvre, exclude it from the planned route and re-route the trip.

Within an active planned route and while viewing the Guidance screen, press View to display the List of Directions screen.

Use the 8-way arrow keypad to select the manoeuvre to be excluded and press Enter.

The details for the manoeuvre you selected are displayed. Select the "Exclude" button and press Enter.

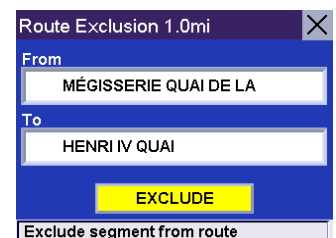
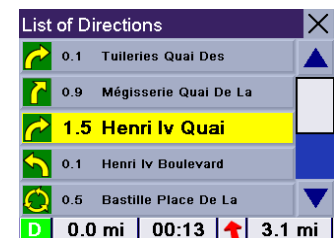
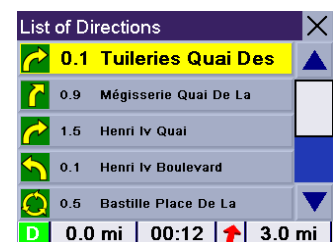

The trip will be re-calculated excluding the selected manoeuvre. This calculation is performed using the same Route Method that was chosen when the destination was selected. Once the route has been recalculated, the Guidance screen will be displayed.

### Canceling a Planned Route

You can cancel a planned route at any time.

While viewing the Guidance screen, the Manoeuvre List screen or the TrueView 3D screen, press the Cancel button.

Select "Yes" and press Enter to cancel the route and display the Destination screen. Selecting "No" and pressing Enter returns the display to the last viewed screen.

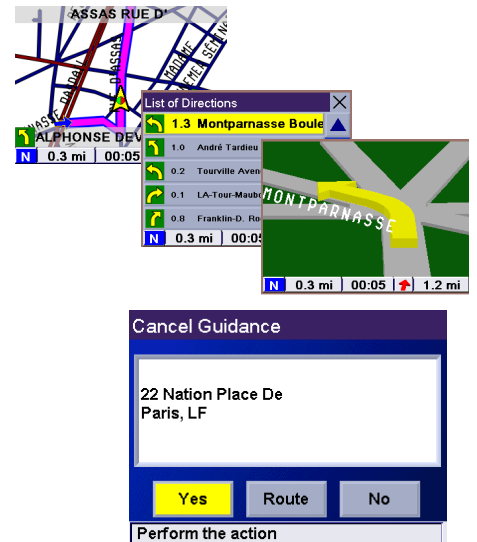

### Changing the Route Method

When you selected the destination for the first time, you indicated which route method you wanted the Magellan RoadMate to use to calculate the route. The Magellan RoadMate provides a way of letting you change the Route Method during the trip.

While viewing the Guidance screen, the Manoeuvre List screen or the TrueView 3D screen, press the Cancel button.

Select "Route" and press Enter.

To cancel this operation, select "No" and press Enter.

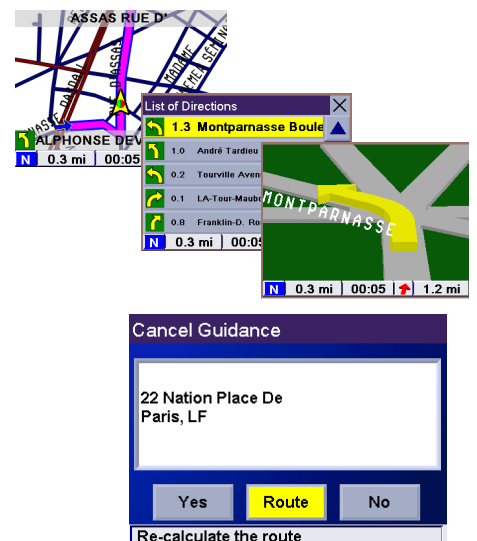

Select the new Route Method and press Enter.

The route will be re-calculated using the newly chosen Route Method and the Guidance screen will be displayed.

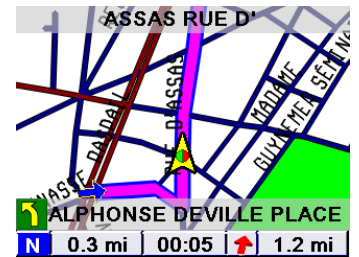
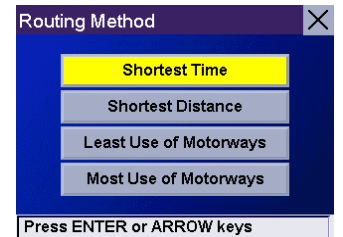

### Displaying Information About Your Present Location

Anytime that you want to view information about your present location you can press the Locate button.

This screen displays the name of the street you are on, the name of the next and previous adjacent streets and information about the town you are in. At the bottom of the screen you can also read your position in Latitude and Longitude.

If you need assistance when travelling, you can communicate this information to ensure that the road assistance or emergency services can quickly locate you.

The right hand side of the screen displays a compass and a speedometer.

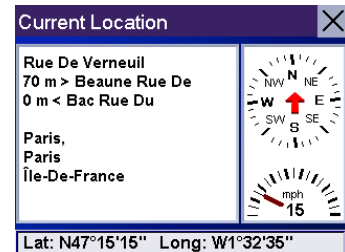



## User Option Choices

The User Options section of Magellan RoadMate provides you with three options: Trip Computer, Configuration and Tutorial. User Options can be accessed from any screen by pressing the Options button.

- Trip Computer Displays useful information about your trip that can be saved for future reference. Ideal for the business traveller who needs to record mileage and time spent on the road.
- Configuration Provides access to customise the look and operation of the Magellan RoadMate.
- Tutorial Provides instructions on how to use the Magellan RoadMate for some of the common functions available.

## Notepad



The driver of the vehicle should never customise the look and operation of the Magellan RoadMate or use the tutorial while the vehicle is in motion.

To access the User Options screen press the Option button.

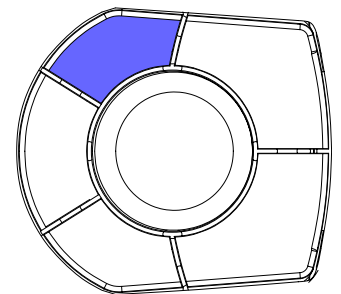

## Using the Trip Computer

The Trip Computer is a valuable tool for anyone using the Magellan RoadMate for business purposes, as well as anyone who wants to record the mileage and time spent driving while on holiday. The information for the trip can be saved to the Magellan RoadMate as a report and viewed at any time, giving you easy access to previous trip information as well as information for the trip you are currently on.

When you begin a new trip and you need to record the information, access the Trip Computer. There you can save the information displayed for the current trip (if needed) and reset the Trip Computer to zero in preparation for your new trip.

### Viewing the Current Trip on the Trip Computer

From any screen press the Option button. Select "Trip Computer" and press Enter.

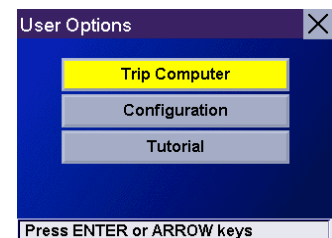

Select "Current" from the list of saved Trip Reports.

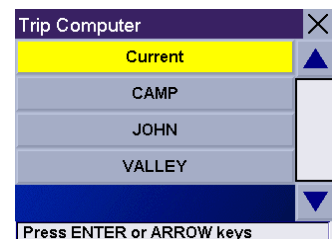

The current Trip Report is displayed with useful information, such as your average speed or the trip distance.

From this screen the Trip Computer can be started or stopped, reset or saved.

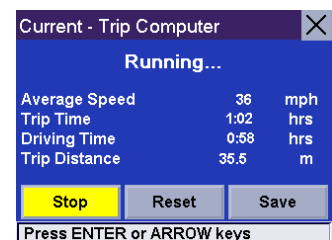

### Stopping or Starting the Trip Computer

Select the "Stop" or "Start" button and press Enter. The top of the display will show "Running..." or "Stopped" depending on the current status of the Trip Computer.

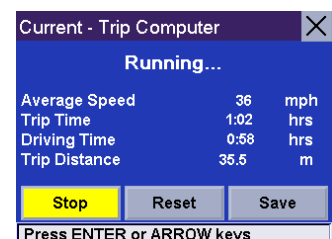

## Resetting the Trip Computer

Select the "Reset" button and press Enter. The values for the Trip Computer will be set to zero. Resetting the Trip Computer will also set the status of the computer to "Running..." if it had been previously stopped.



## Saving the Current Trip Report

Select the "Save" button and press Enter.

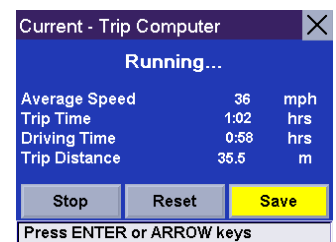

Use the keypad to enter a name for the saved Trip Report. When the name is acceptable, select the "OK" button and press Enter.



## Viewing a Saved Trip Report

From any screen, press the Option button. With "Trip Computer" selected, press the Enter button.

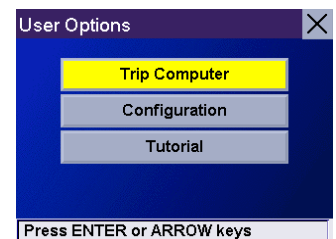

Use the 8-way arrow keypad to select the Trip Report to be viewed and press Enter.

The saved Trip Report is displayed. When you have finished viewing the saved Trip Report you can press Cancel and you will be returned to the "User Options" screen.

### Deleting a Trip Report

From any screen, press the Option button. With "Trip Computer" selected, press the Enter button.

Use the 8-way arrow keypad to select the Trip Report to be deleted and press Enter.

The saved Trip Report is displayed. With the "Delete" button selected, press Enter. The Trip Report is deleted and you will be returned to the "User Options" screen.

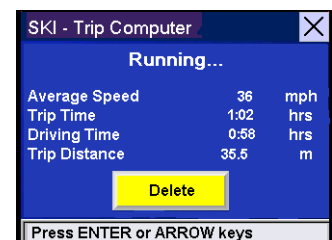
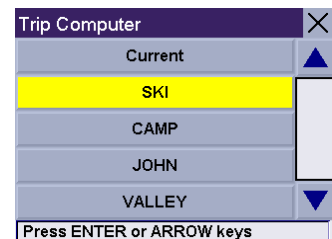
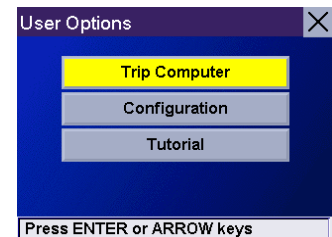
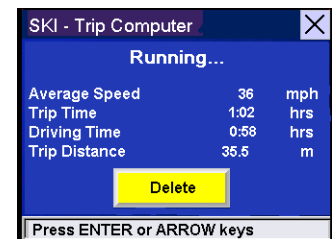
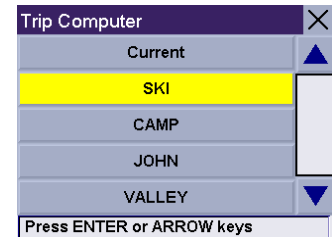

## Configuring the Magellan RoadMate

The configuration options let you customise the Magellan RoadMate to your individual settings. All settings are set for each individual user.

Remember that you must NOT customise your settings while you are driving. If you are operating the vehicle, please bring it to a complete standstill BEFORE you configure your Magellan RoadMate.

From any screen press the Option button. Select "Configuration" and press Enter.

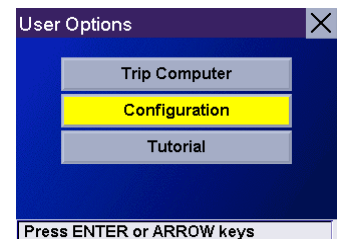

Use the 8-way arrow keypad to select the configuration option you want and press Enter.

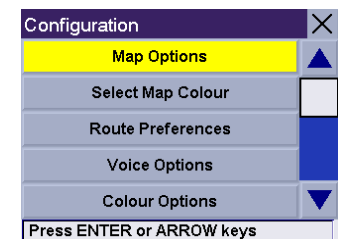

The available configuration options are:

- |                          |  |
|--------------------------|--|
| <b>Map Options</b>       | Set the scrolling map, the Split TrueView mode, the heading of the map and the unit of measurement used. |
| <b>Select Map Colour</b> | Select the map display from nine colour themes. .  |
| <b>Route Preferences</b> | Set your preferences for the calculation of your route and switch automatic re-routing on or off.        |
| <b>Voice Options</b>     | Choose between a Male or Female voice for the guidance instructions.                                     |
| <b>Colour Options</b>    | Select from four colour themes.  |
| <b>Contrast</b>          | Set display contrast level.  |
| <b>Brightness</b>        | Set display brightness level.  |
| <b>Display Options</b>   | Set automatic brightness and contrast.   |
| <b>Tone Options</b>      | Select tone used for alerts before a change of direction.  |
| <b>Language</b>          | Select language for the displays and voice guidance.   |
| <b>Diagnostics</b>       | Perform selected diagnostic tests on the Magellan RoadMate and switch the simulator mode on or off.      |
| <b>User - Edit Name</b>  | Enter or edit name of the currently selected user.   |
| <b>POI Selection</b>     | Select the Points of Interest you want to display on the map.  |

### Setting the Map Options

From any screen, press the Option button. Select "Configuration" and press Enter.

Use the 8-way arrow keypad to select "Map Options" and press Enter.

Use the 8-way arrow keypad to select the option to be changed and press Enter. When the map options are correctly set, select the "Save" button and press Enter.

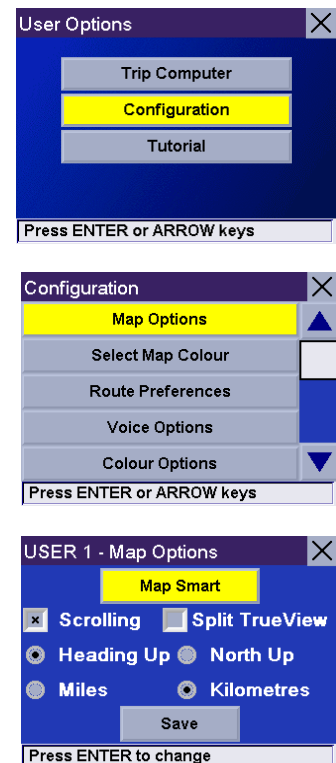

**Guidance Option** Sets the way the guidance information is displayed on the map. Choices are Map Smart, Map Always or Map Manual. Map Smart automatically changes the display from the Guidance screen to the TrueView 3D screen before the manoeuvre. Map Always only shows the Guidance screen and the highlighted route. Map Manual allows the TrueView 3D screen to be displayed only when the View button is pressed.

**Scrolling Map** When ticked, the position of the vehicle will be in the centre of the screen. When unticked, the vehicle icon will move on the Guidance screen until it approaches the edge, at which point it will return to the centre of the display.

**Split TrueView** When ticked, the TrueView 3D screen will be displayed along the Map screen before the manoeuvre.

**Heading Up** Sets the map display so that the direction of travel is always at the top of the screen.

**North Up** Sets the map display so that North is always at the top of the screen.

**Unit of Measurement** Select miles or kilometres as the unit of measurement for distance.

## Setting the Map Colours

From any screen, press the Option button. Select "Configuration" and press Enter.

Use the 8-way arrow keypad to select "Select Map Colour" and press Enter.

Use the 8-way arrow keypad to set your preferred colour theme for the map display. Once you are happy with your choice, select the "Save" button and press Enter.

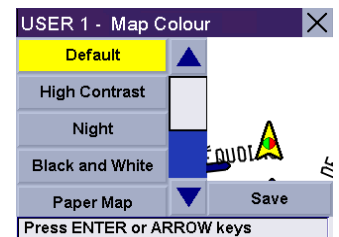
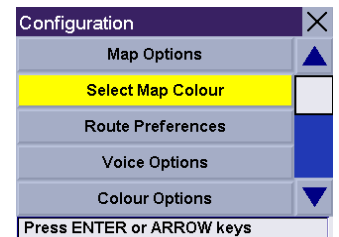
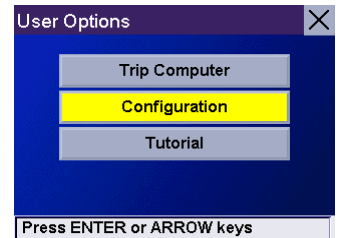

### Setting the Route Preferences

From any screen, press the Option button. Select "Configuration" and press Enter.

Use the 8-way arrow keypad to select "Route Preferences" and press Enter.

Use the 8-way arrow keypad to select the option to be changed and press Enter. When the route preferences are correctly set, select the "Save" button and press Enter.

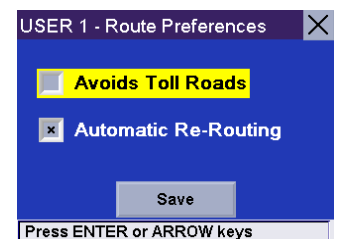
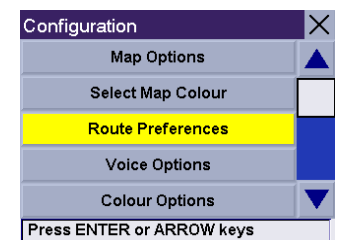
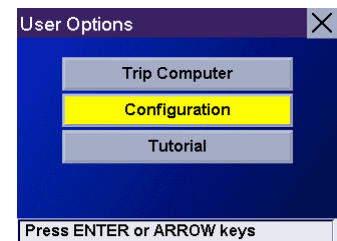

- Avoid Toll Roads** When ticked it instructs Magellan RoadMate to avoid known toll roads when calculating a route.
- Automatic Re-Routing** When ticked, the Magellan RoadMate will make up to three attempts to automatically re-route to the destination when it detects that the vehicle is not on the calculated route.



## Setting the Voice Options

From any screen, press the Option button. Select "Configuration" and press Enter.

Use the 8-way arrow keypad to select "Voice Options" and press Enter.

Use the 8-way arrow keypad to select the Male or Female voice for the guidance instructions and press Enter. When the voice option is correctly set, select the "Save" button and press Enter.

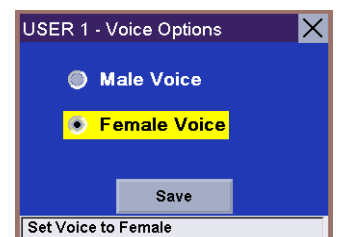
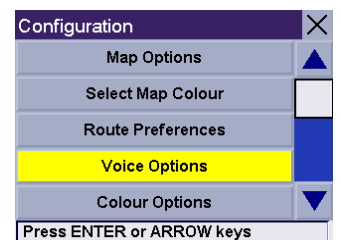
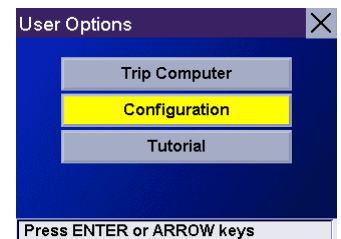

## Setting the Colour Options

From any screen press the Option button. Select "Configuration" and press Enter.

Use the 8-way arrow keypad to select "Colour Options" and press Enter.

Use the 8-way arrow keypad to select your preferred colour theme and press Enter. When you are happy with your choice, select the "Save" button and press Enter.

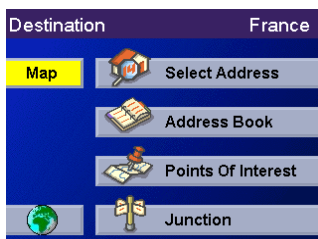
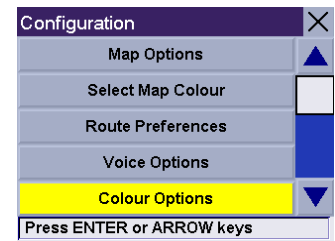
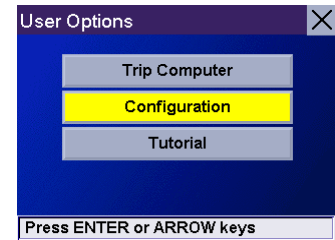

Default



Pastel



Forest



Desert

## Setting the Contrast

From any screen press the Option button. Select "Configuration" and press Enter.

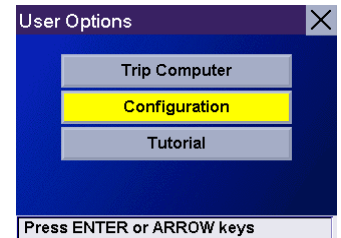

Use the 8-way arrow keypad to select "Contrast" and press Enter.

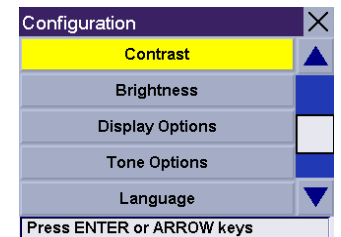

Use the left and right arrows of the 8-way arrow keypad to adjust the contrast. Select the "Save" button and press Enter.

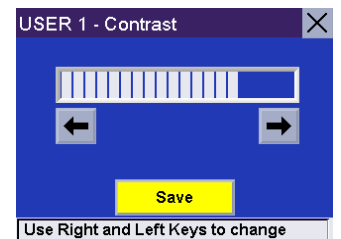

### Setting the Brightness

From any screen press the Option button. Select "Configuration" and press Enter.

Use the 8-way arrow keypad to select "Brightness" and press Enter.

Use the left and right arrows of the 8-way arrow keypad to adjust the brightness level. Select the "Save" button and press Enter.

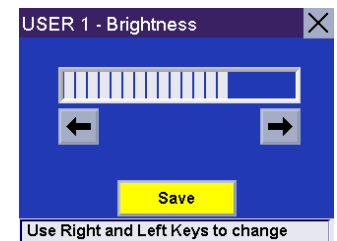
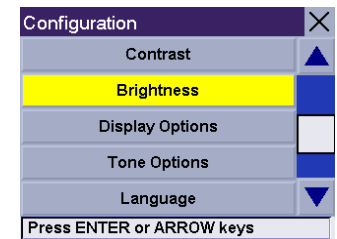
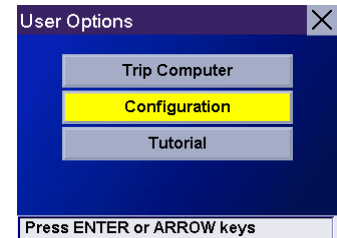

## Setting the Display Options

From any screen, press the Option button. Select "Configuration" and press Enter.

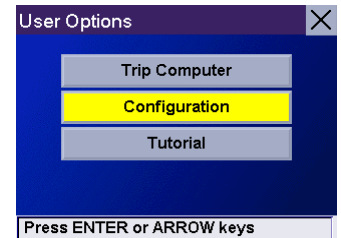

Use the 8-way arrow keypad to select "Display Options" and press Enter.

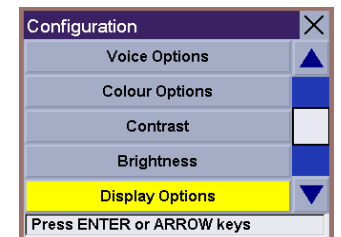

Use the 8-way arrow keypad to select the option to be changed and press Enter. When the options are correctly set, select the "Save" button and press Enter.



- |                                    |  |
|------------------------------------|--|
| <b>Enable automatic brightness</b> | When ticked it instructs the Magellan RoadMate to use its built-in sensor to automatically adjust the brightness of the display. |
| <b>Enable automatic contrast</b>   | When ticked it instructs the Magellan RoadMate to automatically adjust the contrast of the display.                              |

### Setting the Tone Options

From any screen, press the Option button. Select "Configuration" and press Enter.

Use the 8-way arrow keypad to select "Tone Options" and press Enter.

Use the 8-way arrow keypad to select the desired tone and press Enter to hear the sample sound. Select the "Save" button and press Enter when your preferred tone has been selected.

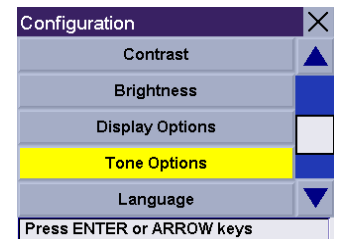
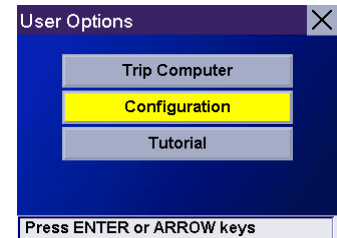

## Selecting the Language

From any screen, press the Option button. Select "Configuration" and press Enter.

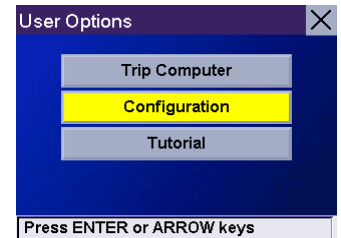

Use the 8-way arrow keypad to select "Language" and press Enter.

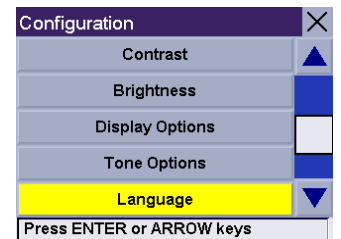

Select the top button and press Enter to step through the different languages available. You can choose from English, French, German, Spanish, Italian and Dutch. The language you select will be set for both the displays and the voice guidance. When the language has been selected, select the "Save" button and press Enter.

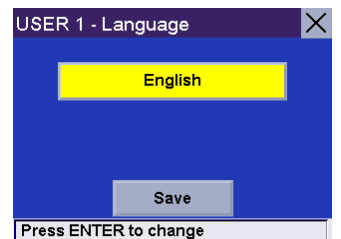

### Performing Diagnostic Checks

From any screen, press the Option button. Select "Configuration" and press Enter.

Use the 8-way arrow keypad to select "Diagnostics" and press Enter.

Select the desired diagnostic test and press Enter. Follow the on-screen prompts to complete the chosen test.

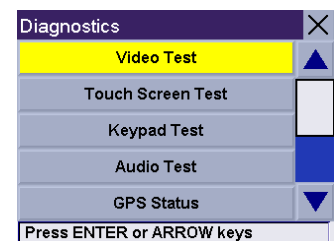
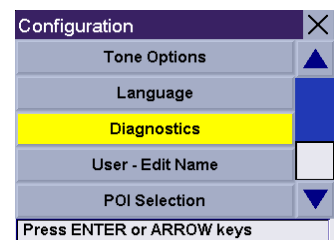
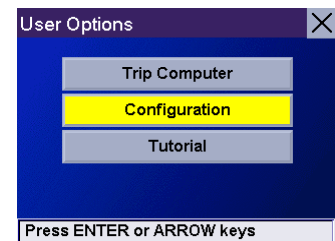

## Notepad



Most of the options available from the Diagnostics screen are not necessary for the normal operation of your Magellan Road Mate.

### Simulator Mode

This menu also features the Simulator Mode option that you can use to simulate your route from your current position to any destination. Select Simulator Mode from the Diagnostics screen. Select the "Start" button and press Enter to activate the simulator mode. You can now select a destination and your Magellan RoadMate will simulate your route to this destination.

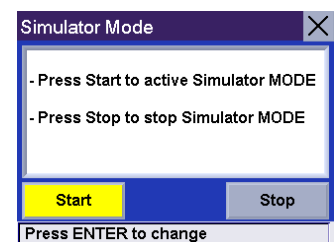



## Editing the User Name

From any screen, press the Option button. Select "Configuration" and press Enter.

Use the 8-way arrow keypad to select "User - Edit Name" and press Enter.

Spell out the desired user name for the selected current user. When the name is completed, select "OK" and press Enter.

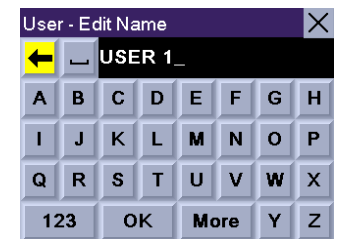
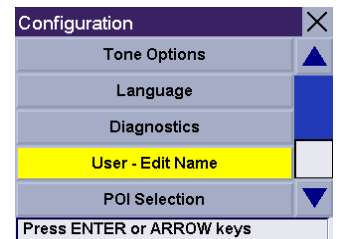
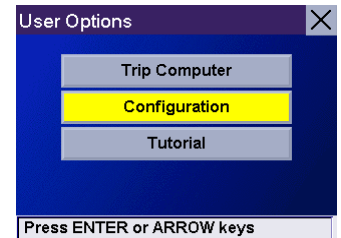

### Selecting the Points of Interest to Display on the Map

From any screen, press the Option button. Select "Configuration" and press Enter.

Use the 8-way arrow keypad to select "POI Selection" and press Enter.

Use the 8-way arrow keypad to scroll down the list and press Enter to check all Points of Interest categories which you want to be displayed on the map. Select "Mark All" and press Enter to display all categories, select "Clear All" to not display any category of Points of Interest.

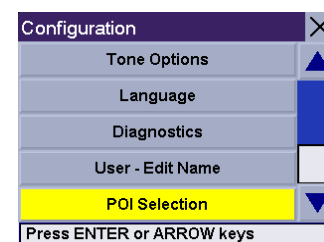
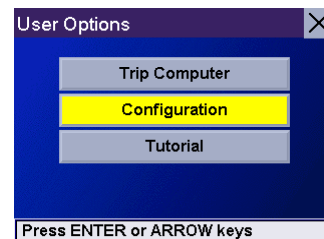

## Using the Magellan RoadMate Tutorial

The Magellan RoadMate has a built-in Tutorial which you can view or refer to whenever the Magellan RoadMate is switched on. Do not use the tutorial while you are driving. If you are operating the vehicle, please come to a complete standstill before you review the tutorial topics.

From any screen, press the Option button. Select "Tutorial" and press Enter.

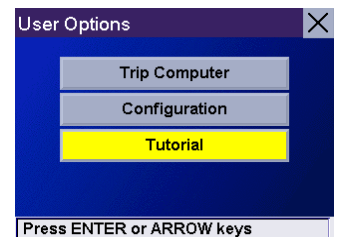

Select the desired tutorial topic and press Enter.

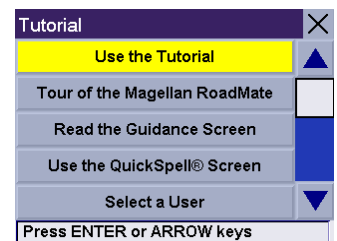

### Moving around the Tutorial

- To skip ahead one step within a topic:** Press right side of 8-way arrow keypad.
- To go back one step within a topic:** Press left side of 8-way arrow keypad.
- To exit the Tutorial:** Press Cancel key.

### Loading Addresses from your PDA or SmartPhone®

You can transfer addresses from your PDA or Smartphone to your Magellan RoadMate through its IRDA Port. This feature is only available for PDAs which use the same IRDA protocol (Palm® OS, Pocket® PC, Symbian®) and for SmartPhone. Simply activate the address transfer function on your PDA or SmartPhone and stand it in front of, and in close proximity to, your Magellan RoadMate. A message will be displayed on your Magellan RoadMate to confirm that the addresses have been successfully transferred to its address book.

Do not transfer addresses to your Magellan RoadMate when you are driving.