







**MAGELLAN GPS
NAV 5200DX™**

USER GUIDE

**Magellan Systems Corporation
960 Overland Court
San Dimas, California 91773
(909) 394-5000
FAX (909) 394-7050**

Rev 0.0 22-10081-000





WARNINGS

A measure of knowledge by the user is required for proper and safe use of the **Magellan GPS NAV 5200DX™**. READ THE USER GUIDE & WARRANTY COMPLETELY.

Use Good Judgment

This product is an excellent navigation aid, but it does not replace the need for careful orienteering and good judgment. Never rely solely on one device for navigating.

Use Care to Avoid Inaccuracies

The Global Positioning System (GPS) is operated by the U.S. Government, which is solely responsible for the accuracy and the maintenance of GPS. Certain conditions can make the system less accurate.



Accuracy can also be affected by poor satellite geometry. WHEN THE ACCURACY WARNING APPEARS ON THE SCREEN, USE THIS DATA WITH EXTREME CAUTION.



THE GLOBAL POSITIONING SYSTEM IS STILL DEVELOPMENTAL. The government can make changes to the system which could affect the performance of GPS receivers. Such a change could require a modification to your NAV 5200DX.



WARNING

The accuracy of position fixes can be affected by the periodic adjustments to GPS satellites made by the U.S. Government and is subject to change in accordance with the Department of Civil GPS user policy and the Federal Radionavigation Plan.





TABLE OF CONTENTS

CHAPTER 1 — INTRODUCTION

The NAV 5200DX	1-1
Specifications	1-2
Packing List	1-5
Accessories	1-5

CHAPTER 2 — UNIT PREPARATION

Installation	2-1
External Power Requirements	2-1
Connecting to an External Alarm	2-2
Antenna Installation	2-2
Unit Installation	2-4
Installing the Data Cable	2-6
Initialization	2-7
Collecting an Almanac	2-10

CHAPTER 3 — BASIC OPERATION

The Keys	3-1
Message Displays	3-2
Memory Loss	3-4
Entering Data	3-4

CHAPTER 4 — FUNCTION KEYS

Light	4-1
Man Overboard (MOB)	4-1



Navigation	4-3
Nav1	4-4
Nav2	4-6
Nav3	4-7
Using Event Markers	4-10
On/Off	4-11
Power-On	4-11
Power-Off	4-12
Position (POS)	4-12
Obtaining a Position Fix	4-12
Position Display	4-14
Position Fix Updates	4-15
Route	4-15
Choosing a Route Mode	4-15
Creating a Route	4-15
The Go-To Route	4-19
Entering Comments	4-20
Activating a Route	4-21
Viewing a Route	4-21
Changing a Waypoint	4-21
Deleting a Waypoint	4-23
Inserting a Waypoint	4-24
Appending a Leg	4-26
Inserting a Leg	4-26
Resetting a Route	4-26
Reversing a Route	4-26
Deleting a Route	4-27
Waypoint (WPT)	4-27
Saving Positions as Waypoints	4-28
Entering Waypoints Manually	4-29
Entering Event Markers	4-30
Saving a Cursor or Boat Position	4-31
Viewing Stored Waypoints and Event Markers	4-31
Renaming Waypoints	4-32
Clearing a Waypoint or Event Marker	4-32

CHAPTER 5 — AUXILIARY FUNCTION KEYS

AUX 1 — Display Control..... 5-2

AUX 2 — Reverse Route 5-2

AUX 3 — Nearest Waypoints 5-3

AUX 4 — Alarms 5-4

AUX 5 — Waypoint Projection 5-6

AUX 6 — Trip VMG 5-7

AUX 7 — SETUP 5-8

 Display Language 5-9

 Entering an Initial Position 5-9

 Selecting a Mode 5-11

 SETUP Worksheet 5-12

 Setting the Time 5-14

 Choosing Automatic or Manual Route Modes 5-14

 Velocity Average 5-15

 Differential Corrections 5-16

 Nav2(A) 5-16

 Nav2(B) 5-16

 Lat/Lon Display 5-16

 Magnetic Variation 5-17

 Distance/Speed Units 5-17

 Elevation Units 5-17

 Date Order 5-18

 Internal Beeper 5-18

 Plot Track 5-18

 Plot Priority 5-18

 Map Datums 5-19

AUX 8 — Satellite Status..... 5-20

AUX 9 — NMEA Output 5-23

AUX 10 — Satellite Schedule 5-23

AUX 11 — Sky Search..... 5-25

AUX 12 — Clear Waypoints/Routes 5-27

AUX 13 — Clear Memory 5-28

⊕

CHAPTER 6 — TROUBLESHOOTING AND OPERATING TIPS

Error and Warning Messages	6-1
Operating Problems	6-4
Unit Turns Off During Use	6-4
Position Fix Doesn't Change	6-4
The "D" Does Not Appear on Position Fix Screens	6-4
Fixes Vary a Lot	6-6
NMEA Device is Not Responding	6-7
Autopilot Does Not Respond	6-7
Second NAV Display Does Not Appear	6-7
Dashes Appear in NAV Displays	6-8
Some Values in NAV Displays Are Not Stable	6-8
Satellite Availability Not To Your Expectations	6-9
Operating Tips	6-10
General	6-10
Unsure of Your Position When Initializing	6-10
Search and Acquisition Errors	6-10
Initialization Error	6-11
The Signal Environment	6-11
Insufficient Number of Satellites	6-12
Unit Searches Constantly	6-13
Accuracy Warning Symbol	6-13
Signal Quality	6-14
<i>Old Data</i>	6-14
Variable Mask Angles	6-14
Adjusting the Display	6-16
Choosing Datum	6-16
Using the Unit Near the Poles	6-17
When Nothing Else Works	6-17
Magellan's Customer Support	6-18

⊕

APPENDICES

Appendix 1 — The Global Positioning System	A-1
Monitoring and Controlling GPS	A-1
How GPS Works	A-2
Accuracy	A-3
GPS Information Sources	A-3
Appendix 2 — Differential Theory	A-5
Correctable Errors	A-5
Non-Correctable Errors	A-6
DGPS	A-7
Appendix 3 — Map Datums.....	A-9
Appendix 4 — Table of Constants.....	A-11
Appendix 5 — Waypoint Log	A-17
Appendix 6 — Function Key Sequences	A-19
Appendix 7 — Glossary.....	A-25
Index	A-31

⊕

LIST OF ILLUSTRATIONS

Figure	Description	Page
2-1	Connecting an External Alarm	2-1
2-2	Connecting an External Alarm with a Separate Power Source	2-2
2-3	Antenna Installation	2-3
2-4	Pole-Mounted Installation	2-4
2-5	Bracket Installation.....	2-5
2-6	NAV 5200DX Rear View	2-6
2-7	Magellan Data Cable Connections	2-7
3-1	Key Placement	3-1
4-1	Understanding the Receiver Activity Display	4-14
5-1	The Route Leg.....	5-15
6-1	Mask Angle with Unobscured Horizon	6-15
6-2	Mask Angle with Obscured Horizon	6-16

This chapter contains a description of the NAV 5200DX, its specifications and accessories.

THE NAV 5200DX



The NAV 5200DX is an affordable, panel- or bracket-mounted GPS receiver that is fast, powerful, and accurate, yet very easy to use. The NAV 5200DX uses five channels working simultaneously to locate and collect data from the GPS satellites. The unit's gallium arsenide circuitry rapidly processes the data received from the satellites to compute current location (Lat/Lon), elevation, and velocity and navigation data in under 1 minute. The unit is also capable of accepting DGPS corrections, applying those corrections to the position solution, and displaying the corrected position fix. This allows the user to overcome the effects of Selective Availability, which introduces errors into the positioning data. (Selective Availability and differential positioning are described in *Appendix 2*.)



All navigation displays can be presented in the user's choice of five languages: English, French, German, Italian, or Spanish.

The NAV 5200DX can be set to use either of two modes to calculate positions: two-dimensional (2D) or three-dimensional (3D). In 2D, the unit uses three satellites to calculate latitude and longitude; elevation is a user-entered variable. In 3D, the unit uses four satellites to calculate latitude, longitude, and elevation.

The NAV 5200DX also stores an initial position and up to 500 waypoints and event markers that are created by the user. These positions can be used to enter routes, to estimate the coordinates and bearing of a distant location, and to mark points of interest on the third NAV screen (the plotter screen). In addition, the NAV 5200DX has a man overboard function, which enables

the unit to mark the location of an accident and establish a route from the present position back to the accident site automatically.

The NAV 5200DX operates from an external power source — usually ship's power. Memory is maintained when the unit is off by an internal lithium battery.

The NAV 5200DX was developed primarily for marine use. It supports most devices that conform to NMEA (National Marine Electronic Association) standards 0180 or 0183. This includes devices such as autopilots, plotters, radars, and sounders. The NAV 5200DX also uses broadcast data from the U.S. Coast Guard DGPS beacons to calculate and display differentially corrected position fixes, which greatly increases the accuracy of the positioning information. (To take advantage of this feature, the NAV 5200DX must be connected to a Differential Radio Beacon Receiver.)

Though a fast, powerful navigation tool, the NAV 5200DX is very easy to use. Data is displayed in both text and easily understood graphics. Additional data can be entered or accessed with a minimum of keystrokes. Most functions can be accessed by pressing only one clearly marked key. Other functions, such as the NMEA control and Sat Status, are accessed through the auxiliary (AUX) key.

SPECIFICATIONS

Physical Characteristics

Unit Size:	8.38" x 5.75" x 2.38" (excluding antenna) (21.29 cm x 14.61 cm x 6.05 cm) 10.63" x 7.11" x 3.02" (bracket-mounted) (27.00 cm x 18.06 cm x 7.67 cm)
Weight:	3 pounds, 1.6 ounces (1.41 kg)

Display:	Backlit Supertwist LCD
LCD Dimension:	3.875" x 3.125" (9.84 cm x 7.94 cm)
LCD Operating Temperature:	-10°C to 50°C
Housing:	Splashproof
Safe Storage Temperature:	-40°C to 70°C
GPS Exterior Antenna:	3.5" (8.89 cm) diameter x 3.5" (8.89 cm) height, plus 50 feet (15.24 meters) of cable.

Data Characteristics

Accuracy:	<p>Position — 15 meters RMS in 2D, without SA. (The accuracy of fixes can be affected by the periodic adjustments to GPS satellites by the U.S. Government, and is subject to change in accordance with the Department of Defense Civil GPS user policy. SA can decrease position accuracy to as much as 100 meters.)</p> <p>Accuracy is 10 meters with differential corrections and SA. This assumes that timing and distance from the reference station are optimum, the reference station is producing accurate corrections, and similar atmospheric conditions at the beacon and the user's GPS receiver.</p>
-----------	---

	Velocity — ± 0.1 knots (HDOP < 2, C/N ₀ ≥ 47 dB-Hz, 2D)
Velocity:	0 to 825 knots (0 to 951 mph)
Time to First Fix:	55 seconds typical (cold start) 35 seconds typical (warm start)
Update Rate:	1 second (2D) typical; may be slower when graphics screens are displayed
Memory:	500 user-stored waypoints and event markers, 19 routes of up to 20 legs each, one Go-To route, and initial position
Modes of Operation:	Choice of two: 2D (solves for Lat/Lon, and time with a user-entered elevation using best three satellites) 3D (solves for Lat/Lon, elevation, and time using best four satellites)

Electrical Characteristics

Power Requirements:	9 – 35 volts DC
Power Consumption:	375 mA without backlight (@ +12 VDC) 675 mA with backlight

PACKING LIST

When you receive your NAV 5200DX Basic Package, you should have all of the following:

- Magellan Nav 5200DX unit, 1
- External antenna with cable, 1
- U-bracket with mounting hardware, 1
- Power Cable, 1
- Field Card, 1
- User Guide, 1

If any of these items is missing, contact your dealer.

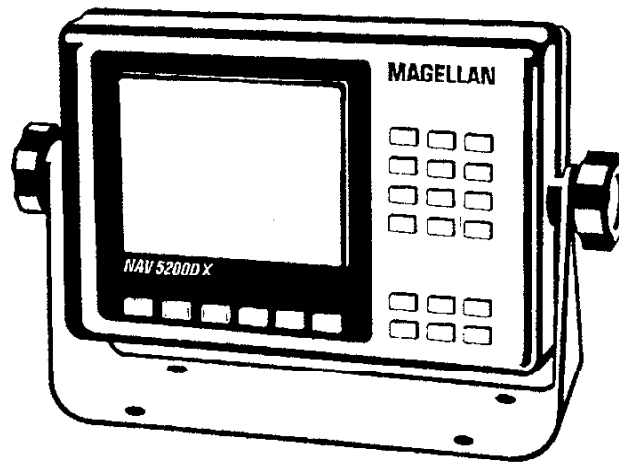

Magellan GPS NAV 5200DX

ACCESSORIES

The NAV 5200DX has several accessories, including a flush-mount bezel to mount the unit in an instrument panel and the Magellan Differential Beacon Receiver (DBR), which is used to receive, demodulate, and relay differential corrections. All accessories for the NAV 5200DX are available from your Magellan dealer.

Introduction

Magellan NAV 5200DX

Chapter 2 UNIT PREPARATION

Before your NAV 5200DX is ready for use, there are several setup tasks that must be completed. This chapter describes these tasks in the order in which they should be performed.

INSTALLATION

Before you can use the NAV 5200DX, both the external antenna and the unit must be installed. The unit must also be connected to its power source, to any NMEA device you want to support, and/or to a compatible differential radio beacon receiver. (The NAV 5200DX is fully compatible with the Magellan DBR.)

The NAV 5200DX Basic Package includes the unit, an external antenna, a U-bracket (to mount the unit on most surfaces), a mounting kit, and a power cable. If you prefer to mount the NAV 5200DX in the instrument panel, you must purchase the Panel Mount Bezel Kit to do so. You will also need to purchase data cables to connect the unit to NMEA devices and/or to a DBR.

External Power Requirements. The NAV 5200DX operates from DC power. A power cable is provided in the Basic Package to connect the unit to any appropriate 9–35 VDC power source.

Refer to Figure 2-1 to connect the power cable to your power source.

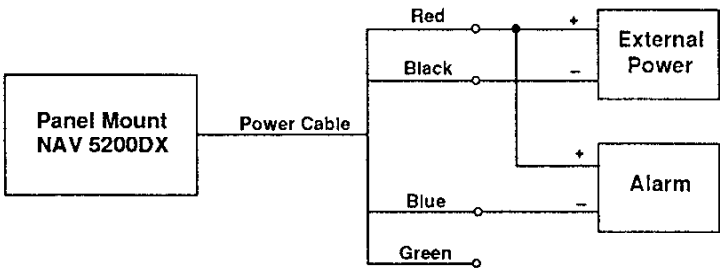

Figure 2-1. Connecting an External Alarm

Connecting to an External Alarm. The NAV 5200DX can support an external beeper or alarm that is connected to the unit through the power cable. Refer to Figure 2-1 to connect an alarm to the unit. If you want to install a separate power source for the alarm, refer to Figure 2-2.

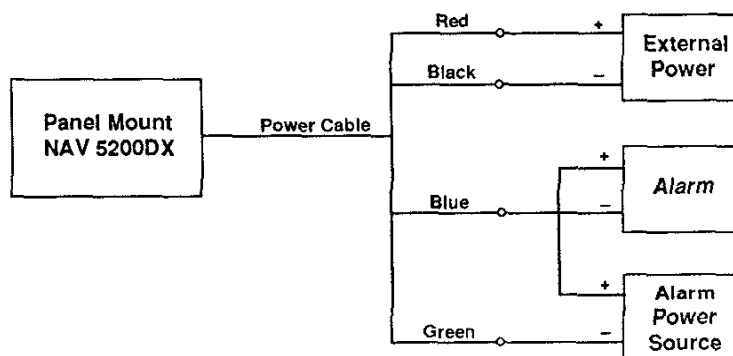

Figure 2-2. Connecting an External Alarm with a Separate Power Source

Antenna Installation. The external antenna should be mounted on a stable, reasonably flat surface where it has a clear, unobstructed view of the sky. (We do not recommend installation on top of a mast.) The antenna should also have a clear view of as much of the horizon as is possible. The antenna should not be positioned next to a mast or other large installation that may block signals.

1. Decide where the antenna is to be mounted, and drill a hole for the cable. Remove any sharp or jagged edges.
2. Position the antenna on the hole, then place the mounting ring over the antenna. Holding the ring steady, mark the center of the four mounting holes in the ring.
3. Remove the ring and antenna, then drill a pilot hole at each mark.

4. Position the gasket on the bottom of the antenna. Attach one end of the antenna cable to the cable connection.
5. Slide the other end of the cable through the hold you drilled in step 1. Route the cable to the NAV 5200DX installation.
6. Place the gasket and antenna over the pilot holes. Align the gasket's mounting holes with the pilot holes. The antenna should be flush with the ones in the gasket.
7. Put the mounting ring over the antenna. Align its mounting holes with the ones in the gasket.
8. Secure with the #10 screws and washers provided.

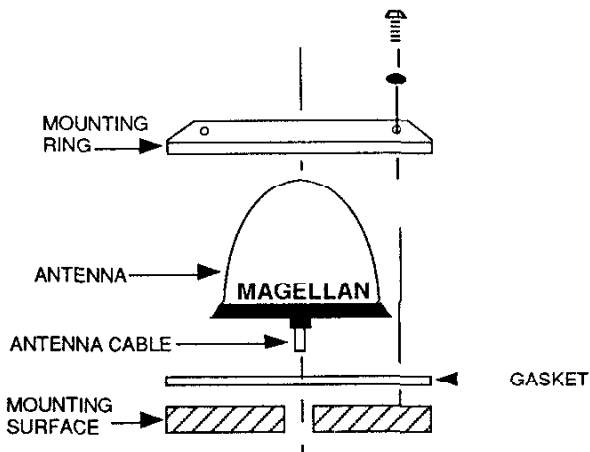

Figure 2-3. Antenna Installation

If you prefer, the antenna can be installed on an antenna mount. (A cone-shaped antenna mount is included in the antenna kit.) The mount has a 1" -14 parallel thread, which can be screwed onto a standard antenna mounting pole.

1. Thread one end of the cable through the hole in the side of the cone-shaped antenna mount.

2. Attach the antenna cable to the cable connection on the bottom of the antenna.
3. Align the mounting holes in the antenna mount with the holes in the antenna.
4. Secure with the #8 screws and washers provided.
5. Screw the antenna mount onto the antenna mounting pole, then route the free end of the cable to the NAV 5200DX installation.

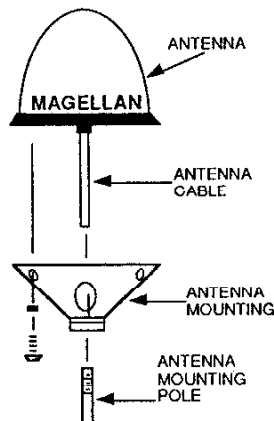

Figure 2-4. Pole-Mounted Antenna Installation

Unit Installation. When determining a location for the NAV 5200DX, remember that the unit should be easily accessible and easily visible. You also should be sure the antenna cable will reach the installation location. Check the distance between the antenna and where you want to install the unit — the cable is 50 feet (15 meters) long.

The NAV 5200DX is shipped with a U-bracket, which can be used to mount the unit to any reasonably flat surface. If you prefer to mount the unit flush in the instrument panel, you must purchase the optional Panel Mount Bezel Kit. (Instructions to mount the unit in an instrument panel are included in the kit.) To connect the unit to NMEA devices or to a DBR, you will also need to purchase one or two data cables.

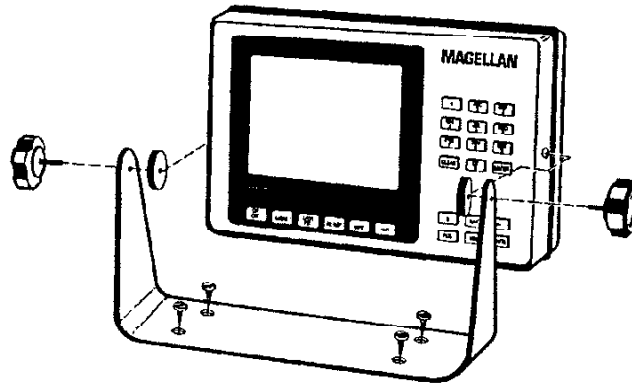

Figure 2-5. Bracket Installation

1. Find an appropriate location for the unit.
2. Position the U-bracket on the mounting surface. Hold the bracket steady and mark the locations of the two bracket mounting holes. Remove the bracket.
3. Drill a pilot hole at each mark.
4. Position the bracket over the pilot holes. Align the mounting holes and secure with the screws provided.
5. Insert the knobs into the holes in the bracket arms, then add a rubber washer to each knob.
6. Insert the unit into the bracket. Tilt the unit to a comfortable angle, and tighten the knobs until the unit is secure.
7. Connect the antenna cable to the unit, at the connection labelled "antenna."
8. Connect the power cable to the unit at the connection labelled "power."
9. If you plan to support an NMEA device or DBR, connect the data cable (not provided) as described in *Installing the Data Cable* below.

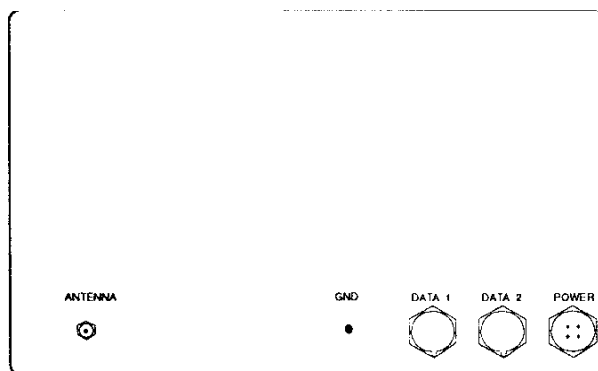

Figure 2-6. NAV 5200DX, Rear View

Installing the Data Cable. The optional data cable is used to connect the NAV 5200DX to external equipment.

The NAV 5200DX can support navigation equipment that conforms to NMEA standards 0180 and 0183. Through its two dataports, the unit can support two NMEA devices at the same time, even if they do not conform to the same NMEA standard. The connection must be made with a Magellan Data Cable. One data cable is required for each NMEA device that will be supported.

The unit can also accept differential corrections from a differential radio beacon receiver through the same dataports. (Magellan's receiver is the Differential Beacon Receiver, or DBR. The following discussion will use "DBR" to refer to all compatible differential radio beacon receivers.) Either dataport can be dedicated to the DBR or a DBR and an NMEA device can be connected to the same dataport. The only requirements are that a Magellan Data Cable be used to make the connection, and that the DBR and NMEA device operate at the same baud rate. (NMEA 0180 equipment uses 1200 baud; NMEA 0183 equipment uses 4800 baud. The baud rates output by DBRs vary.) Check the user guides for your equipment to verify the baud rate used before connecting them to the NAV 5200DX.

NOTE

To support an NMEA device and a DBR through the same dataport and at the same time, the dataport must be turned on with **both** AUX 7 and AUX 9.

Use the following illustration to connect the the data cable to external devices.

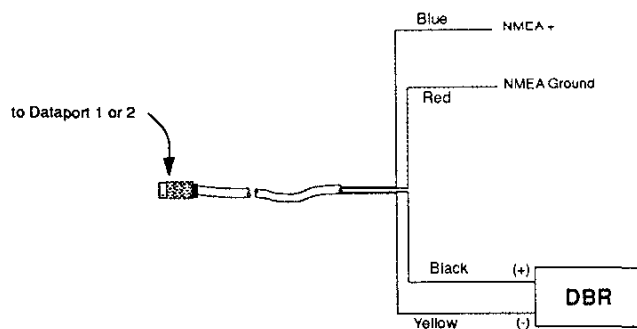

Figure 2-7. Magellan Data Cable Connections

INITIALIZATION

Initialization means telling the unit where it is, what the day and time is, and if necessary, collecting an almanac.

To initialize, you must know your location (latitude and longitude) within 300 miles (482.7 km). You should also know your elevation as accurately as possible. (Note that normal tidal fluctuations do not affect this measurement.) If you do not know your position, call your local marine electronics dealer, or consult an atlas or chart.

Although the unit will automatically initiate Sky Search and self-initialize on power-on if it does not have an initial position, it will be as long as 15 minutes before you get a position fix. It is much faster to enter an initial position manually with AUX 7. It is also possible to operate without having entered an elevation, but

this will affect the accuracy of the position fixes in 2D operation. Therefore, regardless of which mode you plan to use, an elevation should be entered. When a 2D position fix is obtained, the value entered will be used as the default elevation; entering the precise elevation allows the unit to obtain more accurate fixes.

NOTE

We recommend that you read the AUX 7 section in Chapter 5 to fully customize your unit. This section is intended to provide only enough information to set the initial position.

Access AUX 7. Press the **DOWN ARROW** until "INITIAL POSITION" is on the first line, then press the **RIGHT ARROW**.

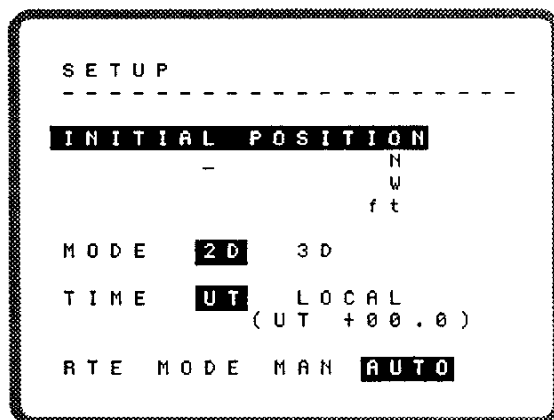
**NOTE**

The unit was initialized at the factory; this is usually cleared before the unit is shipped. Do **NOT** use the factory coordinates as your initial position.

Position coordinates are entered by pressing the appropriate keys on the 10-key keypad, selecting the hemisphere (by pressing the **RIGHT ARROW**), then pressing **ENTER**. Trailing zeros can be entered automatically by keying in the coordi-

nates up to the first zero, then pressing **ENTER**. For example, to enter 34°00.000N, press 3, 4, 0, 0, 0, 0, 0, **ENTER**; you can also press 3, 4, **ENTER**. Errors can be corrected (before **ENTER** is pressed) by pressing **CLEAR**.

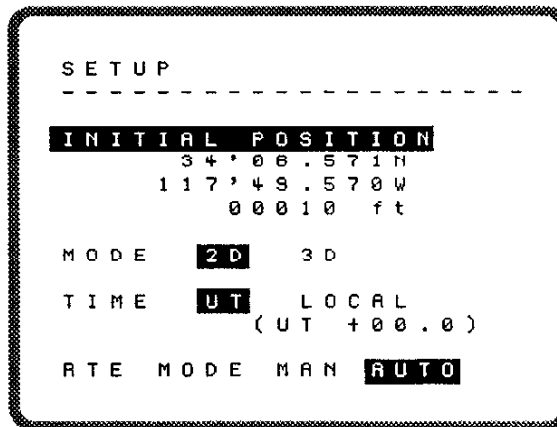
**NOTE**

You must enter your position in the format that is currently selected in SETUP.

The NAV 5200DX can display degrees/minutes (34°06.560N) or degrees/minutes/seconds (34°06'34N). If the unit is being initialized before its first use or after a memory loss, or if the non-default parameters have been cleared, the unit will default to degrees/minutes. The unit will not accept coordinates that are entered in the wrong format.

NOTE

The default hemispheres (before initialization or after memory loss) are North and West. The unit assumes that the hemispheres you choose here (or the hemispheres of the last position fix, whichever is more recent) are current. These hemispheres are offered as your first choice when you enter a waypoint manually.

To continue entering the position, press **ENTER** to highlight longitude. Enter a value for longitude, using the **RIGHT ARROW** to toggle between E and W (if necessary), then press **ENTER** again.

**WARNING**

The coordinates used here may not be your position. You **must** know your position within 300 miles (482.7 km). If you do not know your position, press AUX 11 to initiate Sky Search.

Next, enter an elevation. The default elevation is 0 feet (sea level). If you are currently at sea level, press **ENTER**. To enter a different elevation, press **CLEAR**. Key in the correct elevation, using the **RIGHT ARROW** or the **LEFT ARROW** to toggle between positive and negative values as necessary. Press **ENTER** to save the value.

NOTE

Be sure to enter antenna elevation. Antenna elevation is elevation (your height above sea level) plus the height for the antenna installation above you.

Be sure that the elevation you enter is accurate; this will help the unit to produce more accurate position fixes.

Press any function key to exit AUX 7.

COLLECTING AN ALMANAC

The almanac is a schedule of satellite availability that is maintained by all satellites, and is updated as required by the GPS system operators to reflect current conditions. The unit collects almanac information from any satellite and stores it in its memory. This means that before you obtain a position fix, the unit already knows which satellites are scheduled to be in view

(given your last position or initial position) and where in the sky to look for them.

NOTE

The NAV 5200DX is shipped with an almanac. You should therefore have no difficulty getting your first position fix once the unit has been properly initialized.

The unit collects updated almanac information (and updates its clock) whenever it is tracking satellites. But unless the unit is on and tracking satellites for at least 10 minutes, only part of the almanac can be refreshed in this way. If the unit is in frequent use for 10-minute periods (or longer), it should always have up-to-date almanac information.

When the unit has not been used for more than a few minutes recently (generally, in six months or more), its almanac may be out of date. The almanac may also be out of date if the GPS system operators have changed the status of a satellite. The unit can still obtain a position fix, but it may take a little longer than usual to locate satellites.

Collect a new almanac at any time by pressing AUX 11 to initiate Sky Search.

NOTE

Once a satellite signal has been located, it takes about 12-1/2 minutes to collect a complete almanac.

Chapter 3

BASIC OPERATION

This chapter contains basic information required to operate the NAV 5200DX.

THE KEYS

The NAV 5200DX has three types of keys: function keys, operation keys, and alphanumeric keys. The function keys are the four keys on the lower right of the display, plus the AUX and MOB keys on the lower right keypad. These keys are used to access the unit's functions and to select non-default operating parameters. The operation keys are the two keys on the lower left of the screen, the arrow keys on the lower right keypad, and the ENTER and CLEAR keys at the bottom of the alphanumeric keypad. They are used to turn the unit and display light on and off, to scroll through information displays, and to save or delete information. The alphanumeric keys are used to input information and, when used with the AUX key, to access auxiliary functions.

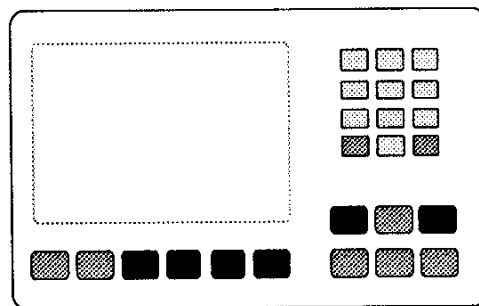

■ Function Keys ▨ Operation Keys ▩ Alphanumeric Keys

Figure 3-1. Key Placement

Detailed information relating to specific keys are found in Chapters 4 and 5.





NOTE

Always press all keys squarely and firmly.

MESSAGE DISPLAYS

The NAV 5200DX displays a variety of messages during the operation of the unit. Most messages appear as an icon on the first line of the screen during normal operation; they are intended to alert the operator to an existing condition. A few messages appear on the first two lines of the screen, and indicate receiver activity or appear when the unit is unable to perform the function selected; these are described in Chapter 6.

The following icons and messages may appear on the first line of the screen during normal operation.

-  **Geometric Quality** — Appears on all position screens when the Geometric Quality (GQ) of a position fix falls to 3 or below. The position fix may not be accurate enough to be depended on for navigation.
-  **Signal Quality** — Appears on all position screens when the Signal Quality (SQ) of a position fix falls to 3 or below. The strength of one or more satellite signals is weak, and the receiver may lose its lock on it. This has a minimal effect on accuracy, and is intended only to alert the user that a signal may be lost.
-  **Differential Correction** — A differential correction has been applied to the position displayed. If a differentially corrected position fix has a low SQ, the SQ icon will be displayed instead of "D". This icon is not stored when a position is saved as a waypoint.
-  **Old Data** — Appears when the unit has been unable to compute and display a position fix update for the past 10 seconds. This occurs when the signal from one or more satellites is lost and the unit has been unable to

recover the signal. The position fix that is displayed is at least 10 seconds old, and should not be used for navigation.

ANCHOR ON — Appears on the first line of all displays when the anchor alarm is on and the unit is taking fixes.

ARRIVAL/XTE ALARM ON — Appears under the CDI (at 0.0) on Nav1 and Nav2 and between "POS" and "CURSOR" on Nav3 when the arrival and/or the XTE alarm is on.

NOW IN 2D — This line appears for a few seconds on power-on when the unit has been set to 2D operation.

NOW IN 3D — This line appears for a few seconds on power-on when the unit has been set to 3D operation.

→ **Right Arrow** — Appears on the upper right of the screen when you have the option of scrolling through the waypoint catalog while performing another function, such as when defining a route or using waypoint projection.

ALM COLLECT — This message appears on the first line of the screen when the unit is collecting an almanac. Do not turn the unit off while this message is displayed.

ALM VERIFY — This message appears on the first line of the screen when the unit is verifying the almanac information it just collected. Immediately follows Almanac Collect. Do not turn the unit off while this message is displayed.

SKY SEARCH — This message appears on the first line of the screen when the unit is searching for satellites in order to collect an almanac.

NOT ENOUGH SATELLITES UP — Appears on the top of the screen when there are insufficient satellites to obtain a position fix in the current mode of operation.

MEMORY LOSS

The unit loses memory when AUX 13 has been used to clear all memory. When a memory loss occurs, the unit loses its initial position, almanac, the non-default parameters (selected in SETUP), and all stored routes and waypoints.

The unit should be re-initialized before it is used. There are three ways you can re-initialize the unit. One is to initialize as described in *Initialization*, Chapter 2, then collect an almanac with AUX 11.

You can also self-initialize with AUX 11 (Sky Search). If the unit has no initial position when AUX 11 is selected, the unit will accept the position fix calculated with the first three satellites the receiver locates and acquires as the initial position. This method will take longer than initializing manually.

The unit will enter Sky Search automatically if it has no almanac when the unit is turned on or when POS, MOB, or NAV is pressed when almanac is out of date; if it has no initial position, the unit will also self-initialize. Once Almanac Collect and initialization are complete, POS, MOB, or NAV information will be displayed. (It is possible to self-initialize by pressing NAV only if waypoints and a route have already been entered.)

ENTERING DATA

Information must be entered into the unit from the alphanumeric keypad to enter an initial position, to manually enter a waypoint, or to name or retrieve a waypoint.

Look at the keypad. It is arranged in the same way as your telephone keypad (reverse 10-key). Each key is assigned to a number and two or three letters.

To enter position coordinates, simply press the appropriate alphanumeric keys until the latitude is entered, press the RIGHT ARROW to change the hemisphere, then press ENTER. Trailing zeros can be entered automatically by keying in all of the digits before the first trailing zero, then pressing ENTER. The empty

spaces will be filled in with zeros. (This does not work when the zeros are at the front or middle of the coordinate.) Once ENTER has been pressed you can key in the longitude, followed by ENTER. If you are operating in the 3D mode, you may now enter elevation, followed by ENTER, or simply press ENTER again to use the elevation of the last position fix. (In 2D operation, elevation is assumed to be the one used for the initial position.)

If you pressed the wrong key (and ENTER has not been pressed yet), press CLEAR and the unit will erase the last digit selected.

NOTE

Only numbers are available when entering position coordinates. Letters are available only when entering a waypoint or event marker name and when WPT has been pressed. You cannot enter a letter as a coordinate.

Waypoint names are entered to create a waypoint or to retrieve a waypoint that has already been created. When entering a name for a new waypoint, press the alphanumeric key that corresponds to the character you want, then press the RIGHT ARROW until the desired character is displayed. Press ENTER to move to the next character. Press ENTER again when the name is complete to save the name.

Waypoints are retrieved by pressing an alphanumeric key followed by the RIGHT ARROW until the desired character is displayed, then another alphanumeric key, and so forth. ENTER is not pressed until all of the desired characters are displayed. (Waypoint entry and retrieval are described in Chapter 4.)

Event markers are stored positions whose names start with an icon. They are most often used on the Nav3 (plotter) display. Event marker names are entered by pressing the RIGHT ARROW before any alphanumeric key is pressed. This causes the unit to display + in the first character space. Press the RIGHT ARROW



again to select Δ or \square . The rest of the event marker name is keyed in as described above. To retrieve a stored event marker, press 1, then the RIGHT ARROW until the desired icon is displayed.

Both waypoint and event marker names can also be entered automatically. To enter a waypoint name automatically, press ENTER without keying in any characters. The unit will assign a name in the format WPxxx, where "xxx" is a number from 001 to 999. To name an event marker automatically, you must first enter an event marker icon as described above. When the desired event marker icon is displayed, press ENTER. The unit will assign an event marker name in the format Xevyyy, where "X" is the event marker icon and "yyy" is a number from 001 to 999.



Chapter 4

Function Keys

The function keys are used to operate the NAV 5200DX and to access information. The keys discussed in this chapter are described in alphabetical order.

LIGHT

The LIGHT key backlights the message display. Press this key to turn the light on and off.

The light turns off automatically when the unit is turned off.

The brightness and contrast of the display when the light is on can also be modified with AUX 1.

MAN OVERBOARD (MOB)

The man overboard (MOB) function is used in an emergency situation to immediately save the current position. Since MOB is usually pressed while moving, the function also provides navigation information to return to the vicinity of the original position.

Pressing MOB creates waypoint mob, which is the current position at the time MOB is pressed, and establishes a route from the present position to the vicinity of waypoint mob. (If you are navigating on a route when MOB is pressed, the route is replaced by the mob route.) In addition, the unit constantly updates your position along the mob route.

All mob route information is presented on three navigation displays, which are identical in most respects to the displays described in *Navigation*. The only difference is in the screen shown below; waypoint mob's coordinates are displayed above the CDI.

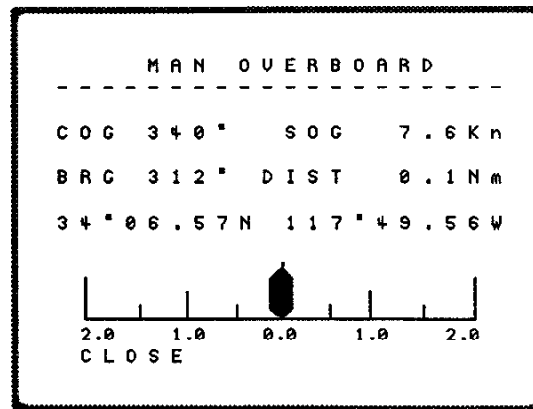

This screen is the first one shown when MOB is pressed. To view the other MOB navigation displays, press **NAV**.

Use the navigation information presented on the MOB displays to return to the vicinity of the original position.

NOTE

When you enter the arrival circle for the position saved as mob, the unit displays "CLOSE." This message is displayed only on the lower left of the first MOB navigation screen. The unit indicates only that you are now in the vicinity of the original position; it will not display "ARRIVED" or "COMPLETE".

Waypoint mob is retained by the unit until it is deleted or replaced, even if the unit is turned off.

The waypoint can be accessed with the WPT key to be deleted or copied; it is one of the last waypoints in the list, just before the event markers. Waypoint mob cannot be accessed when creating a route. To use the position in a route, the waypoint must first be copied to another name.

Waypoint mob is replaced by saving a new position with the **MOB** key.

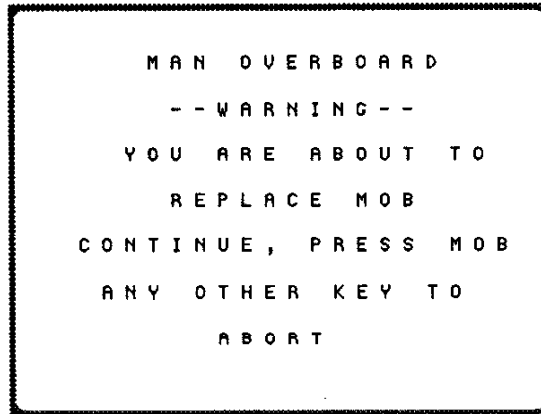

Pressing **MOB** while the unit already has a mob position saved causes the unit to generate a warning. If you really want to replace the existing mob waypoint, press **MOB**. To stop the procedure, press any other key.

The MOB function can be exited at any time by pressing any function key (other than MOB) or by turning the unit off.

The MOB route can be restarted after the function is exited or the unit is turned off. Press MOB to display the warning, then press NAV to navigate from your present position to waypoint mob.

NAVIGATION (NAV)

The NAV key provides information that relates your progress along a route to the destination of the current leg.

When a route or mob route has been activated, NAV provides distance, bearing, and velocity information that is referenced to the route. A route is not required to display velocity information or track on Nav1 and Nav3. Nav2 is not displayed unless you are navigating a route.

Navigation information is displayed on three screens.

Nav1. The first NAV screen displays course over ground, speed over ground (referenced to the speed units selected with AUX 7), bearing and great circle distance from the present position to the destination waypoint, and a CDI.

Press **NAV** once to view the first navigation screen.

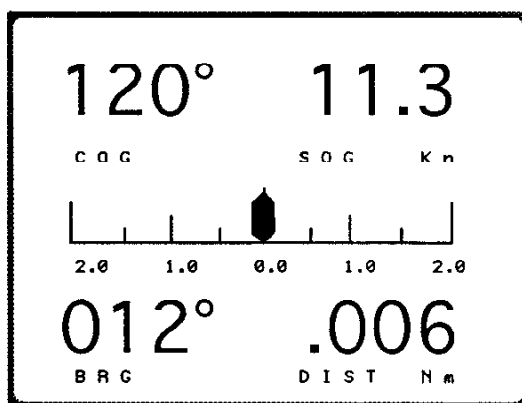

COG (course over ground), in the upper left of the display, is the true direction of travel achieved. It is sometimes referred to as ground course.

SOG (speed over ground), to the right of COG, is actual ground speed measured as instantaneous ground speed and direction. SOG is displayed in the speed units that were selected with AUX 7 (SETUP).

NOTE

Both COG and SOG are velocity-related measurements. The unit will not calculate values for COG and SOG unless your speed is at least 0.2 knots.

Since COG and SOG are based on instantaneous speed, you may notice some fluctuation in the values displayed for them. This

effect can be "smoothed" by using a weighted average instead of instantaneous speed. Refer to *AUX 7 — SETUP, Velocity Average* to substitute a weighted average.

The CDI (course deviation indicator) is a graphical representation of the cross track error. The cross track error is the length of the perpendicular between your present position and the courseline. It is described as being to the right or left of the courseline, facing the destination.

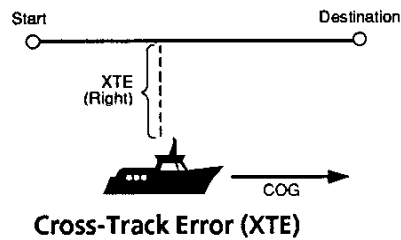

The CDI includes a course indicator, a vessel indicator, and scale markers. The scale markers represent a preset distance from the courseline. Each marker is 1/4 of the scale you select.

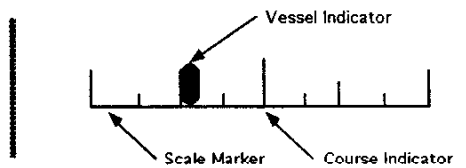

You may display a scale of 0.2, 0.4, 1.0, 2.0, 4.0, or 8.0 by pressing the RIGHT ARROW while the CDI is displayed. The unit of measurement (Nm, km, statute mile) used by the CDI is selected in *AUX 7*.

When you are on course, the course indicator is at the center of the scale. (The NAV 5200DX follows maritime convention by placing the course indicator at the center of the scale.) When off course, the vessel indicator appears to the left or right of the course indicator, depending on the direction of the cross track error.

Cross track error cannot be computed when you are 9.99 nautical miles or more from the course line. If this occurs, the unit displays "INVALID LEG" and the vessel indicator appears on the far side of the CDI.

Nav2. The second navigation screen displays all of the information shown in Nav1 plus the start and destination waypoints of the current route leg and two parameters that are selected in AUX 7: VMG, ETA, TTG, SOA, XTE, DMG, or steering. The CDI is displayed and can be modified here as well as in Nav1. (If this screen is being displayed with the MOB key, the user-selected parameters are replaced by waypoint mob's coordinates; refer to page 4-2.)

Route-related messages such as "ARRIVED" are displayed on the last line.

Press **NAV** again to display the second navigation screen.

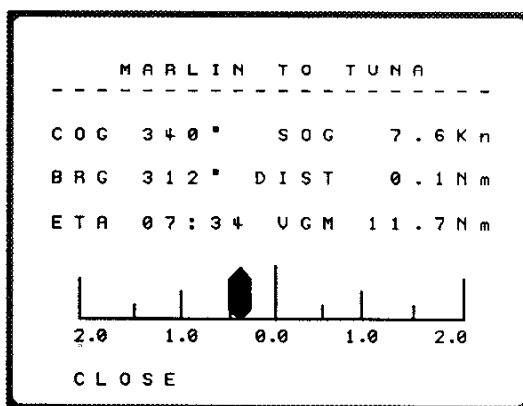

3

Nav3. The third navigation screen is a feature-laden plotter display of the current leg and your position in relation to that leg. It also displays bearing to the leg's destination, groundspeed, the current setting for the cursor movement scale, the current display scale, and the coordinates of the current position. If the optional cursor is displayed, bearing and distance to the cursor are also shown. When track is turned on with AUX 7, the unit also displays the actual course travelled.

Magnetic north is always at the top of the display; the leg is always depicted in relation to its compass orientation.

Track (the actual course travelled) is displayed as a solid line behind the boat icon when the track feature has been turned on with AUX 7. If the actual course travelled coincides with the course line, the track is on top of the course line and is not visible. Once the track reaches its longest length (as defined with AUX 7), the oldest portion of the track is deleted to accommodate new information.

The display scale is the distance that is shown on the screen as measured from one side edge to the other. The unit can display .25, 1, 5, 10, 25, 50, or 500 distance units; the unit of measure used is the one that was selected with AUX 7. The display scale is adjusted by pressing 1 to increase the scale and 2 to decrease the scale. Once the scale has been changed, the new scale will be retained until the unit is turned off.

NOTE

We do not recommend using .25 unless you are receiving differential corrections.

When the plot screen is first accessed, the unit uses the display scale that will show the entire leg. If the leg is too long to be shown at 100 units, the unit will display as much as possible at 100 units and will center the display on the feature that has plot priority.

NOTE

When the end of a leg is displayed, the unit will also display the first part of the next leg. The destination/start waypoint is not displayed, unless you used an event marker when defining this part of the route.

The unit can give priority to the boat, the cursor (which is described later), or the route. When conditions do not permit displaying all three features on the same screen, the unit will focus on the feature that has priority. When the boat has priority your current position is always at the center of the screen. If the cursor has priority (and the cursor has been turned on) the cursor position is at the center of the screen. When the route is given priority, the center of the current leg is at the center of the display.

Plot priority can be changed with AUX 7 or from the Nav3 display. (Refer to Chapter 5 to change plot priority with AUX 7.) Press 6 to toggle through priority selections (boat, cursor, route). When boat has priority, a second boat icon appears next to "POS." Cursor cannot be selected as the priority unless the Nav3 cursor is on; priority will return to boat when the Nav3 cursor is turned off.

NOTE

Plot priority can be changed in Nav3 or with AUX 7. The priority selected remains unaltered until changed with either Nav3 or AUX 7.

The optional cursor is used to position event markers on the display. (Entering event markers is described in *Using Event Markers*.) It is not displayed when Nav3 is first accessed. To turn the cursor on, press any arrow key. Move the cursor by pressing the arrow keys. Once the cursor is turned on, the unit displays its bearing and distance from your current position (at the boat icon). To replace bearing/distance with cursor coordinates, press 3. Press 3 again to return to bearing/distance.

The cursor movement scale is the distance in pixels the cursor will move when an arrow key is pressed. You may select any number from 1 to 8, with 4 being the default value. The scale is changed by pressing 4 to move to a lower value and 5 to move to a higher value. The change in scale is retained until the unit is turned off, when the unit will return to a value of 4.

Press **NAV** again to view the plot screen.

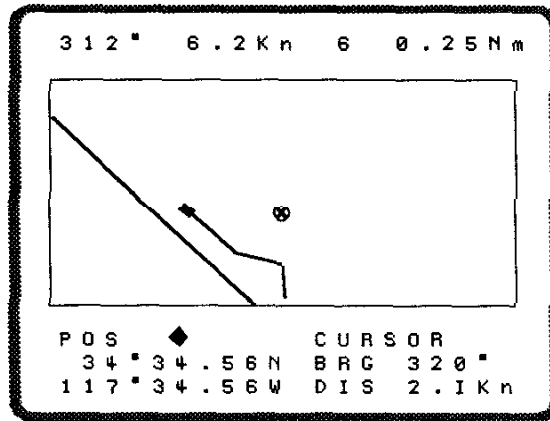

Remember which alphanumeric keys are "hot" when viewing the Nav3 display:

- 1 zooms in on the display
- 2 zooms out of the display
- 3 toggles between bearing/distance to the cursor position, cursor coordinates, and turns the cursor off. (Cursor is turned on and moved with any arrow key.)
- 4 decreases the cursor movement scale
- 5 increases the cursor movement scale
- 6 toggles through the priority display features (boat icon, cursor position, route)

From the Nav3 display, press **NAV** to return to the Nav1 display.

NOTE

When returning to the Nav3 display, event markers will not appear for a few seconds

Using Event Markers. Event markers are user-entered positions along the route leg that illustrate features or specific conditions. They can be positioned at the boat position or at the cursor.

First, decide if you want to position a marker at the boat position or the cursor. To use the cursor position, turn the cursor on and move it to the desired location with the **ARROWS**. The bearing and distance of the cursor from the boat position is displayed in the lower right corner of the plotter screen; refer to this to position the cursor accurately.

Press **ENTER**. Highlight either BOAT POS or CURSOR POS, then press **ENTER** again. The unit displays the coordinates of the selected position with a blank for name entry. Key in an event marker name as described in *Entering Data* and press **ENTER**.

WAYPOINT / EVENT ENTRY	
BOAT POS	CURSOR POS
0010ft	34° 06.553N 117° 49.566W

NOTE

You cannot navigate to an event marker without first setting a separate route.

ON/OFF

The ON/OFF key turns the NAV 5200DX on and off.

Once turned on, the unit remains on until ON/OFF is pressed or power is lost.

Power-On. The NAV 5200DX performs a self-test each time it is turned on.

The first display is a "title page," which is shown while the unit conducts a brief self-test of its memory, almanac, and power.

Once the self-test is complete, the unit checks the almanac to determine which satellites are scheduled to be in view, and which of the available satellites will give the best geometry for a position fix given the time, mode of operation (2D/3D), and the unit's last known position. If satellites are available, the unit automatically turns the receiver on to search for satellites and obtain a position fix. The screens displayed during the search of and acquisition of satellites are described in *Position (POS)*, *Obtaining a Position Fix* and *The Position Display*.

If no satellites are scheduled to be in view, the receiver will remain off and the unit will display "NOT ENOUGH SATELLITES UP." Check Satellite Status with AUX 8 to be sure that all satellites are set to on, then press POS to recheck satellite availability and calculate a position fix or select AUX 10 to compute a schedule of availability.

If the unit is left with the "NOT ENOUGH SATELLITES UP" message, the receiver will turn itself on when enough satellites to obtain a position fix become available. This may be a wait of several hours, depending on your mode of operation and location.

Power-Off. To turn the unit off, press the ON/OFF key again. When the ON/OFF key is pressed while the unit is on, the unit begins a countdown from 5 to 0 seconds. This countdown is displayed on the screen.

When the counter reaches 0 seconds, the unit turns off. The countdown can be interrupted and the unit returned to normal operation at any time before 0 seconds is displayed by pressing any function key twice.

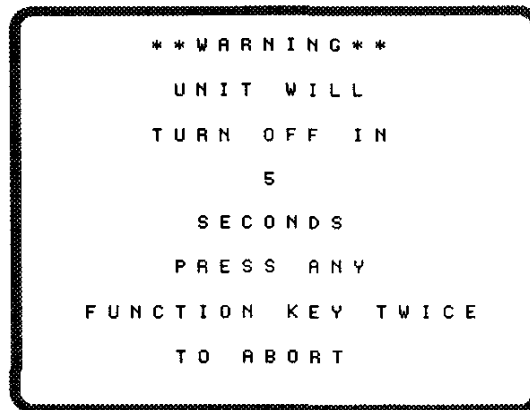

The unit can be turned off immediately by pressing ON/OFF a second time at any time during the countdown before 0 seconds.

POSITION (POS)

The unit obtains position fixes automatically when the receiver is on. These position fixes are displayed as soon as they are computed unless another feature has been accessed.

The POS key is used to return to the position display after using another feature.

Obtaining a Position Fix.

Press **POS**. The unit may display "COMPUTING" on the top line of the screen as it checks its almanac for satellite availability (given your initial position or last fix)

and determines which satellites will be used in the position fix solution. Within a second or two, if satellites are scheduled to be in view, the unit begins to search for satellites.

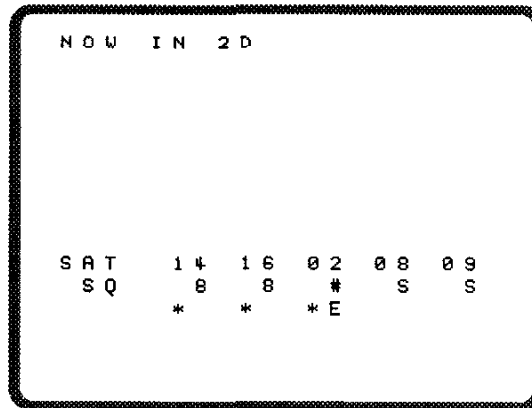

NOTE

If the unit does not have an almanac or has not been operated for more than a few minutes in the past six months, the unit enters Sky Search to locate a satellite, collect a current almanac, and self-initialize before calculating a position fix. (Refer to *AUX 11 — Sky Search.*)

The first satellite is usually located in a few seconds, but may at times, take up to a minute. If the satellite cannot be located, the unit looks for the satellite with the next highest elevation.

Once the first satellite has been located, the receiver collects ephemeris data from it while the search for satellites continues on the remaining four channels. Throughout the search and acquisition, the unit monitors the activity of all five channels. Refer to the illustration below to interpret the receiver activity portion of the POS screen.

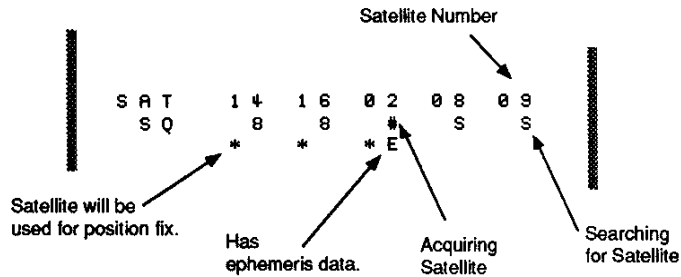

72

Figure 4-1. Understanding the Receiver Activity Display

The Position Display. A position fix is calculated and displayed when the unit has found and acquired enough satellites for the operation mode you have chosen. If the unit was initialized correctly, the first position fix can be made in 55 seconds or less. Subsequent fixes can be made in about 30 seconds, if the previous fix was made in the last hour and you are using the same set of satellites.

This screen is displayed as soon as a position fix has been calculated. It includes the date and time the fix was obtained, the mode of operation, the current datum, which satellites were used, the signal quality (SQ) of each satellite signal, and the geometric quality (GQ) of the fix. (SQ and GQ are described in Chapter 6.)

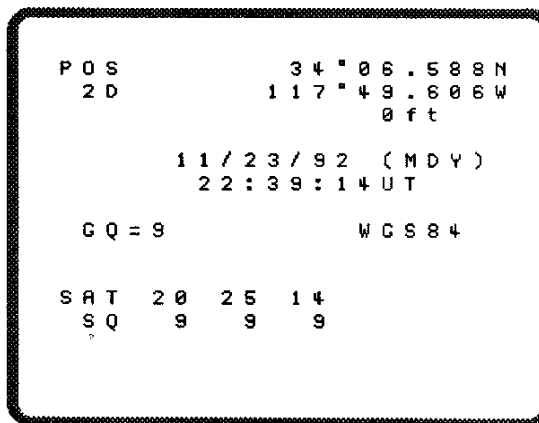

72

Position Fix Updates. The position fix is normally updated approximately once every second, unless a satellite sets or its signal becomes blocked.

If a lost satellite signal cannot be relocated, the unit will “swap in” a new satellite. This rarely takes more than 1 second, but if it does, the most recent position fix is displayed with an Old Data symbol.

The unit will also “swap in” different satellites if a set with a better projected GQ becomes available. You will notice this only if you monitor the satellites used portion of the position fix display.

You may perform other functions, such as entering a route or checking satellite status and schedule while the receiver is on. This will not interrupt the update rate. Once the receiver has been turned on, it will remain on and will continue to update the position fix until the unit is turned off.

ROUTE

A route is a planned course of travel from one place to another. It is also a record of that planned course of travel that is stored by the unit. The ROUTE key allows you to enter and store one 1-leg route (the Go-To route) and as many as 19 multi-leg routes of up to 20 legs each. You can enter a 12-character description for all 19 routes, view, edit, reverse, and navigate on a route.

Choosing a Route Mode. A route can be followed in either the automatic route mode, in which legs are switched automatically, or in the manual route mode. Route mode is selected with AUX 7, and is described in Chapter 5.

Creating a Route. A route is created by using a series of waypoints to define a course from one place to another. It can also be broken into a series of mini-routes, or legs, with the destination of one leg being the start of the next leg.

NOTE

A route cannot be created unless waypoints have already been stored. Attempting to create a route when no waypoints exist in the unit's memory will cause the unit to display a "SET WAYPOINTS TO CONTINUE" message.

Press the **ROUTE** key. The screen displays GOTO and the first five route records. GOTO is the Go-To route; the remaining route records are identified by number. Each route record may also have an optional user-entered description. Undefined records are identified by "EMPTY ROUTE."

NOTE

The Go-To route is described in the next section.

ROUTE		

GOTO		EMPTY ROUTE
ROUTE 1	MARLIN-SLIP	
ROUTE 2	HARBOR-2-BAY	
ROUTE 3	HBR-CATALINA	
ROUTE 4	EMPTY ROUTE	
ROUTE 5	EMPTY ROUTE	

Scroll through the catalog with the **UP/DOWN ARROW**. Highlight an unused record to enter a route and press **ENTER**. (If an undefined route record is not available, delete a record you do not need anymore.)

Select the starting point for the first leg. The current position (POS) is always displayed first. To use a waypoint, either press the **RIGHT ARROW** to scroll through the stored waypoints or enter all or part of the waypoint name. You may also use stored event markers. Press **ENTER** when the desired position is displayed.

You may choose POS as the starting or destination waypoint of any leg. When POS is selected, it is stored as waypoint "strtxx", where "xx" is a number from 1 to 19 that corresponds to the route number. POS is no longer available, but waypoint strtxx can be used again to define another leg of the same route.

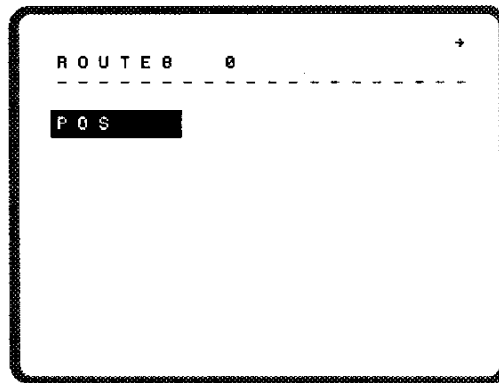

NOTE

The "strtxx" waypoint from one route cannot be used in another route, and is not displayed when you scroll through waypoints from ROUTE. If you want to use strtxx in another route, copy it as described in *Renaming Waypoints*.

Select a destination by scrolling through the stored waypoints and event markers with the **RIGHT/LEFT ARROW** or key in all or part of the waypoint/event marker name. Press **ENTER** when the desired position is displayed.

NOTE

If you decide not to continue entering this route, you can abort **before** the destination waypoint is selected. Exit ROUTE by pressing any function key; if the destination waypoint for the first leg has not been completed (by pressing ENTER), the route will not be saved.

Once **ENTER** has been pressed, the unit automatically moves to the next leg, and uses the destination of the first leg as the start for the new leg. At the same time, the number at the center of the first line increases by one. This number indicates which leg you are currently defining.

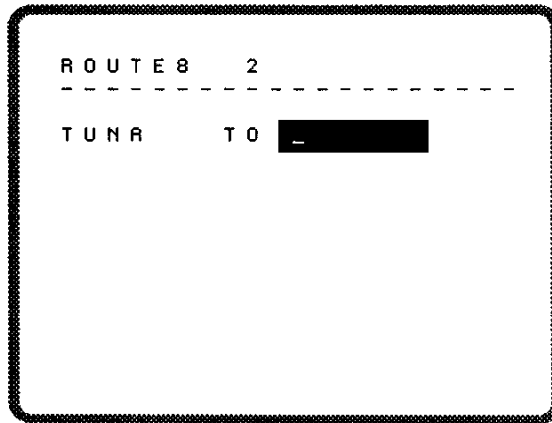

Choose a destination for the second leg as described above. Continue until you have completed your route or until all 20 legs have been set.

Press ENTER after selecting the route's destination waypoint to view the start/destination and bearing/distance calculations for the first four legs and bearing/distance calculations for the entire route. This will also activate the first leg for navigation.

ROUTES	3	110.33	NM

HARLIN	TO	TUNA	
320		3.56	NM
TUNA	TO	PORT	
45		54.00	NM
PORT	TO		
5		12.30	NM
HARBOR	TO	SLIP	
342		6.35	NM

31

You can also press any function key to exit ROUTE without viewing the route. This will cause the last leg of the route to be the active leg. If you will be navigating on any route, we recommend pressing ENTER to start on the correct leg or selecting another route as described in *Activating a Route*.

Press any key other than **ENTER** to exit the ROUTE function.

The Go-To Route. The Go-To route is a one-leg route from the present position to any user-selected waypoint. It is created as described in *Creating a Route*, with the exception that the starting waypoint is always the current position and only one leg can be defined.

At first glance, the Go-To route and the mob route appear to be the same. There are actually several differences. The Go-To route directs you to the destination waypoint or event marker; the mob route directs you to the general vicinity of waypoint mob. You will get a "COMPLETE" message at the conclusion of the Go-To route. Also, the route is not constantly redefined. A mob route always assumes that the present position is the route's starting position, which means that the course line is updated with each position fix update. A Go-To route uses the present position at the time the route was defined as the starting waypoint; position fix updates affect only your present position and displayed track along the defined course line.

To define the Go-To route, highlight GOTO and press **ENTER**. Select a destination by scrolling through the stored waypoints with the **RIGHT/LEFT ARROW** or entering all or part of the waypoint or event marker name. Press **ENTER** to save the route, then press any key to exit the ROUTE function.

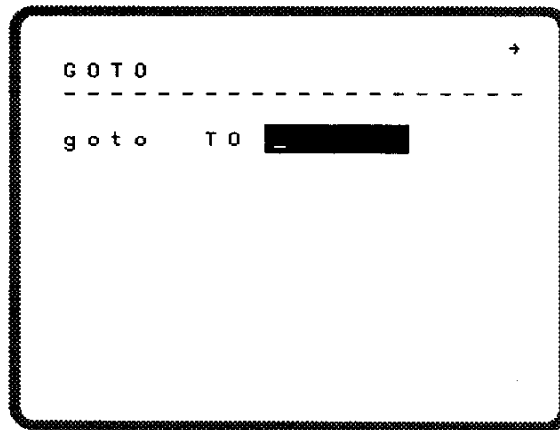

Entering a Go-To route creates waypoint goto. Waypoint goto is similar to waypoint mob and strtx in that it will be overwritten when this feature is used again and the waypoint cannot be used in other routes. To save the coordinates of waypoint goto or to use the position in another route, you must copy it to another name. This is done by using the procedure described in *Renaming Waypoints*.

Entering Comments. A descriptive comment can be entered at any time to a defined route. The comment is displayed as part of the route catalog.

A comment is entered by simply highlighting the desired route and keying in some text. You may enter up to 12 characters. (Since a blank space is not available, we suggest that you use a hyphen to separate words.) Press **ENTER** when finished to store the comment.

If no comment is entered, the unit displays "NO COMMENT".

Activating a Route. A previously created route must be activated in order to navigate on it and to display navigation information.

To activate a route, press **ROUTE** and use the **DOWN ARROW** to highlight the desired route. Press **ENTER**.

Scroll through the route with the **DOWN ARROW** until the desired leg is the first leg on the screen or until the number of the desired leg appears on the first line. Press **NAV**. The selected leg becomes the current leg; all navigation information displayed will be in relation to that leg.

Viewing a Route. A route can be viewed at any time by pressing the **ROUTE** key, highlighting a route, and pressing **ENTER**.

Press **ROUTE** and use the **UP/DOWN ARROW** to select a route. Press **ENTER**. Use the **ARROWS** once again to scroll through the defined legs.

Changing a Waypoint. Routes can be edited in four ways; by replacing one waypoint with another, by deleting a waypoint, by adding a waypoint, and by appending legs. This section describes how to replace one waypoint with another.

First, access the route as described in *Viewing a Route*. Use the **DOWN ARROW** to highlight either of the two legs in which the waypoint you want to change appears. Press the **RIGHT ARROW** to highlight the waypoint.

NOTE

It does not matter if the waypoint highlighted is in the start or destination position; the unit will automatically change the waypoint at the highlighted position and at the start/destination position with which the highlighted position is paired.

```

    ROUTES  2  110.33 NM
    -----
    TUNA    TO  PORT
      45 °   54.00 NM
    PORT    TO  HARBOR
      5 °   12.30 NM
    HARBOR  TO  SLIP
      342 °  6.35 NM
  
```

21

Press any alphanumeric key. This immediately deletes the waypoint at the highlighted position.

```

    ROUTES  2  110.33 NM →
    -----
    TUNA    TO  [ ]
      45 °   54.00 NM
    PORT    TO  HARBOR
      5 °   12.30 NM
    HARBOR  TO  SLIP
      342 °  6.35 NM
  
```

212

Key in the name of the new waypoint or press the **RIGHT ARROW** to scroll through the waypoint catalog. Press **ENTER** when the desired waypoint or event marker is displayed. The unit will automatically change the selected waypoint in the highlighted leg and in the previous/following leg, and will recompute the legs' bearing and length displays and the length of the entire route.

Deleting a Waypoint. Deleting a waypoint has the effect of shortening the route by one leg.

Access the route as described in *Viewing a Route*. Use the **DOWN ARROW** to highlight either of the legs in which the waypoint appears. Press the **RIGHT ARROW** to highlight the waypoint.

NOTE

It does not matter if the waypoint highlighted is in the start or destination position; the unit will automatically delete the waypoint at the highlighted position and at the start/destination position with which the highlighted position is paired.

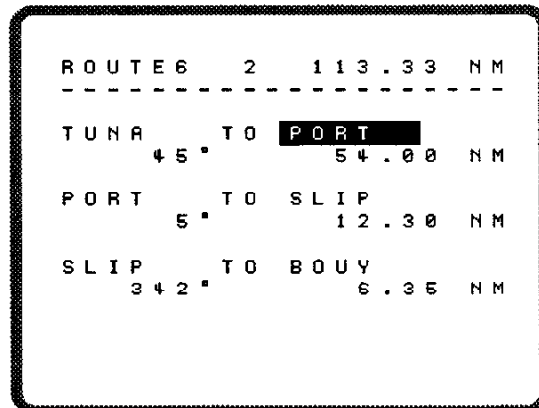

21b

Press **CLEAR**. The unit removes the highlighted waypoint from both legs, and combines the legs into one. The change is saved automatically.

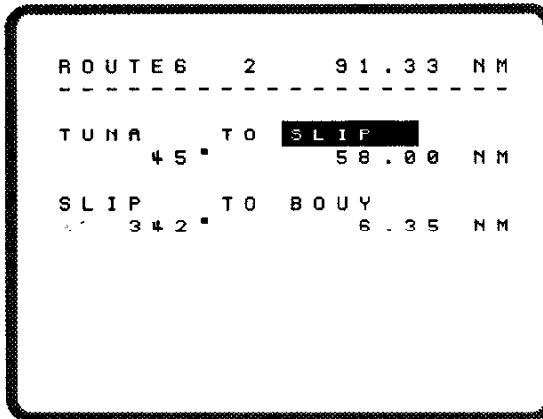

```

ROUTE 6 2 91.33 NM
-----
TUNA TO SLIP
45° 58.00 NM
SLIP TO BOUY
342° 6.35 NM
  
```

21c

Inserting a Waypoint. Inserting a waypoint into the middle of a route has the effect of creating an additional leg.

Access the route as described in *Viewing a Route*. Use the **DOWN ARROW** to highlight the leg in which the new waypoint will be inserted. Press the **RIGHT ARROW** to highlight either the start or the destination waypoint.

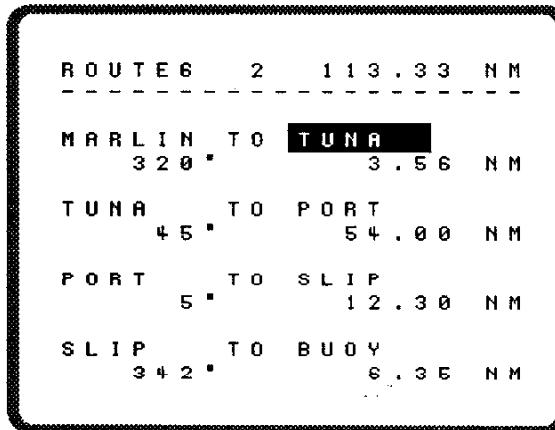

```

ROUTE 6 2 113.33 NM
-----
MARLIN TO TUNA
320° 3.56 NM
TUNA TO PORT
45° 54.00 NM
PORT TO SLIP
5° 12.30 NM
SLIP TO BUOY
342° 6.35 NM
  
```

21d

NOTE

It does not matter if the waypoint highlighted is in the start or destination position; the unit will automatically divide the leg in which the highlighted waypoint appears.

Press **ENTER**. The unit divides the leg in two between the start and destination waypoints. The destination waypoint of the original leg becomes the destination waypoint of the new leg. Blanks are displayed for the start waypoint of the new leg and the destination waypoint of the previous leg.

ROUTE 6	2	113.33	NM	→
MARLIN	TO			
320°			3.56	NM
	TO	TUNA		
45°			54.00	NM
TUNA	TO	PORT		
5°			12.30	NM
PORT	TO	SLIP		
342°			6.35	NM

2/e

Highlight either blank, then select a waypoint by entering all or part of a waypoint name or by using the **RIGHT ARROW** to scroll through the waypoint catalog. Press **ENTER** when the desired waypoint is displayed. The unit inserts the displayed waypoint into both blanks and recomputes all displayed bearing and leg/route distances. The change is saved automatically.

Appending a Leg. A new leg can be added to the end of a route at any time.

To append a leg, select a route and highlight the destination waypoint of the last leg. Press **ENTER**.

The unit adds a new leg. Enter a new destination waypoint as described above. Press **ENTER** when the desired waypoint is displayed, then either continue to add legs or press **ENTER** again to save the appended leg.

Inserting a Leg. New legs can also be added to the route. This is done by inserting new waypoints between the starting waypoint and the destination waypoint of an existing leg.

Locate the leg where the new waypoint is to be inserted. Highlight either the start waypoint or the destination waypoint and press **ENTER**.

The unit inserts two legs between the start and destination waypoints of the original leg, both of which include a blank waypoint field.

Highlight either blank and select a waypoint, then press **ENTER**. The waypoint name is duplicated at the other blank automatically. Press **ENTER** again to save the route as changed.

Resetting a Route. A route can be reset at any time by pressing ROUTE and selecting a new route or leg, and then pressing POS or NAV.

If you are supporting an NMEA device, we recommend that you first turn off the device or put it into standby before resetting a route. After you choose another route or leg, reactivate the dataport (by pressing POS or NAV), then reactivate the device.

Reversing a Route. Reverse Route is an auxiliary function (AUX 2) that allows you to reverse the waypoint order of any route. This means you can navigate from one place to another, reverse

the route, and navigate back to your original starting point without manually entering a new route for the return trip.

Refer to *AUX2—Reverse Route* in Chapter 5 to reverse a route.

Deleting a Route. Delete routes when they are no longer needed. This will ensure that you always have at least one route record available when necessary.

To clear a route, press **ROUTE** and highlight the desired route. Press **CLEAR**. The unit displays "CLEAR ?" below the route number. To delete the highlighted route, press **CLEAR** again. The unit displays "CLEARING" as the route is being deleted. The cleared route will be identified by "EMPTY ROUTE."

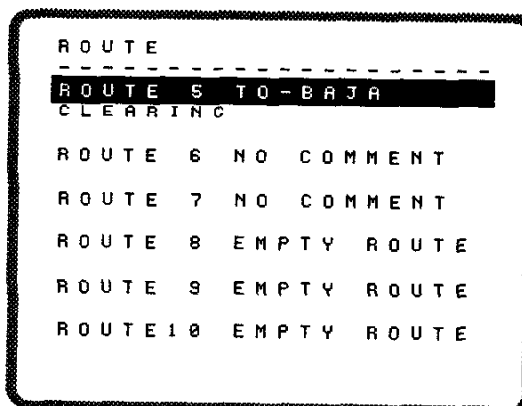

WAYPOINT (WPT)

The WPT key lets you enter up to 500 positions in the unit's memory as waypoints or event markers by saving a current position or by manually entering a position.

Waypoints and event markers can be entered, viewed, deleted, and renamed. Waypoints are stored in alphanumeric order, and are followed by WPxxx, anchor, goto, mob, strbxx, and event markers. Event markers are in alphanumeric order after the initial marker icon. Icon order is +, Δ, and □.

Saving Positions as Waypoints. Any current position can be saved as a waypoint while it is being displayed. SQ, GQ, and date of entry are not retained by the unit; only the position coordinates are saved.

While a position fix (POS) is being displayed, press **ENTER**. The unit displays the waypoint log, with the current position and an entry blank.

Name the waypoint. Key in one to six characters as described in *Entering Data* in Chapter 2 and press **ENTER**. If the name you choose is already being used, "EXIST!" is displayed in the name field. Press **ENTER** and key in another name.

WAYPOINT LOG			

01100	ft	34° 34.567N	
01100	ft	117° 39.543W	
WP001		34° 06.543N	
01100	ft	117° 48.542W	
WP002		34° 06.543N	
01100	ft	117° 45.456W	
WP003		34° 05.542N	
01100	ft	117° 04.432W	

If you prefer, the unit can name waypoints automatically. Simply press **ENTER** without entering any text; the unit will generate a name in the format WPxxx, where xxx represents 001 through 999. The numbers are assigned in sequence.

NOTE

Use waypoint names that are easy to remember, and keep a log of waypoints that you have stored as a reference. This is especially important if you use the unit-generated waypoint names. A sample waypoint logbook page is included at the back of this manual.

Entering Waypoints Manually. Use the following key sequences to enter a waypoint manually.

Press **WPT, ENTER**. Key in a one- to six-character waypoint name from the alphanumeric keypad, or press **ENTER** again to name the waypoint automatically. Move to the next entry position by pressing **ENTER**.

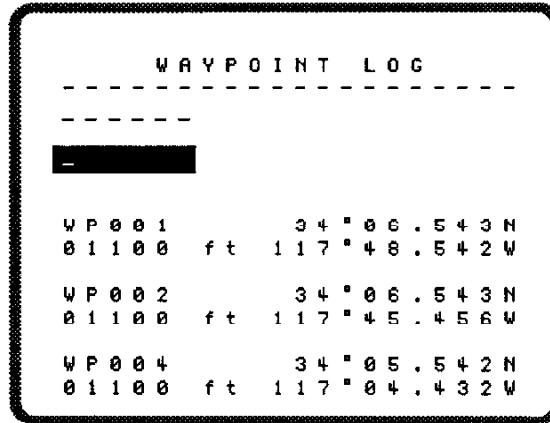

Enter the latitude; if necessary, press the **RIGHT ARROW** to change hemispheres after the value has been keyed in. (Be sure you enter the coordinates in the currently selected Lat/Lon format.) Press **ENTER**. Key in the longitude, pressing the **RIGHT ARROW** as necessary. Press **ENTER**. Key in an elevation followed by **ENTER**. To use the default elevation, press **ENTER** without making an entry.

To enter another manually entered waypoint, press **WPT, ENTER**.

The unit will display "ALL WPTS IN USE" if there is no memory to store more waypoints. You must delete a waypoint before another can be stored.

NOTE

If you press ENTER without keying in an elevation, the unit will automatically use the elevation entered during initialization or the elevation of the last position fix as the elevation of the waypoint.

Entering Event Markers. An event marker is a saved position or a manually entered position whose name starts with one of three icons. They are displayed automatically on the Nav3 (plotter) screen when they fall in the area being shown; in all other respects, event markers can be used in the same manner as waypoints.

To name an event marker, press the **RIGHT ARROW**. The screen will display "+". Other available icons are "Δ" and "□", which are accessed by pressing the **RIGHT ARROW** again. (If you pass "□", the unit will display "1"; this is not available as an icon. You must press the **RIGHT ARROW** again to reach "+".)

In addition to the icon, enter up to 5 alphanumeric characters. Press **ENTER** when the desired character is displayed to move to the next entry blank. When the event marker name is complete, press **ENTER**. If you are entering position coordinates manually, key in latitude plus **ENTER**, then longitude plus **ENTER**. Key in a value for elevation followed by **ENTER**, or press **ENTER** without making an entry to use the default elevation.

An event marker name can also be entered automatically. First, enter an event marker icon as described above. When the desired event marker icon is displayed, press **ENTER**. The unit will assign an event marker name in the format Xevyyy, where "X" is the event marker icon and "yyy" is a number from 001 to 999.

If you are entering markers to define a physical structure or related conditions, we suggest using names such as ΔREEF1, ΔREEF2, and so forth. Remember that each marker must have a unique name.

Saving a Cursor or Boat Position. Positions can also be saved from the Nav3 (plotter) display. This is described in *NAV, Using Event Markers*.

Viewing Stored Waypoints and Event Markers. Waypoints and event markers are stored in the memory in alphanumeric order, with WPxxx listed first, user-named waypoints, anchor, goto, mob, strtxx, user-named event markers, then unit-named event markers.

Waypoints and event markers can be accessed in two ways, by scrolling through the catalog or by entering all or part of the name and allowing the unit to do the search.

Press **WPT**. The unit displays a blank line and the first four waypoints in memory.

Press the **DOWN ARROW** to scroll through the catalog. Press **ENTER** when the desired position is displayed.

WAYPOINT LOG			
WP001		34° 34.567 N	
01100	ft	117° 39.543 W	
WP002		34° 06.543 N	
01100	ft	117° 48.542 W	
WP003		34° 06.543 N	
01100	ft	117° 45.456 W	
WP004		34° 05.542 N	
01100	ft	117° 04.432 W	

13

If you prefer, press any alphanumeric key to enter the waypoint name; to enter an event marker name, press **1**, then the **RIGHT ARROW** to select the appropriate icon. When all or part of the position name has been entered, press **ENTER**. (This method will not look for waypoints anchor, goto, mob, or strtxx.)

Renaming Waypoints. A waypoint or event marker can be renamed at any time, as long as the new name is not already in use. This procedure can also be used to copy position data from waypoint anchor, waypoint mob, waypoint goto, or waypoint strtxx to another name, and to change a waypoint to an event marker.

Highlight the desired waypoint file, then press **ENTER**. Key in the new name, followed by **ENTER** or any **ARROW**.

To change a waypoint to an event marker, press the **RIGHT ARROW** to select an event icon before keying in any alphanumeric character.

Clearing a Waypoint or Event Marker. Use the following key sequence to delete a waypoint or event marker from the unit's memory.

Use **WPT** to select the waypoint/event marker, then press **CLEAR**. Be very sure that the highlighted waypoint/marker is the one you want to erase before pressing **CLEAR**.

NOTE

Waypoints assigned to a route cannot be erased.

To clear **all** waypoints and event markers, use **AUX 12**.

Chapter 5

AUXILIARY FUNCTIONS

In addition to the nine function keys described in Chapter 4, the NAV 5200DX has 13 auxiliary functions. The auxiliary functions provide additional information and control over how the unit displays information.

The auxiliary functions can be accessed two ways.

Press **AUX** and the number of the auxiliary function you want to access, followed by **ENTER**. The unit highlights the function you selected. Press **ENTER** again to access the function.

OR

Press **AUX** and use the **DOWN ARROW** to scroll through the auxiliary functions until the one you want is highlighted. Press **ENTER** to access the function.

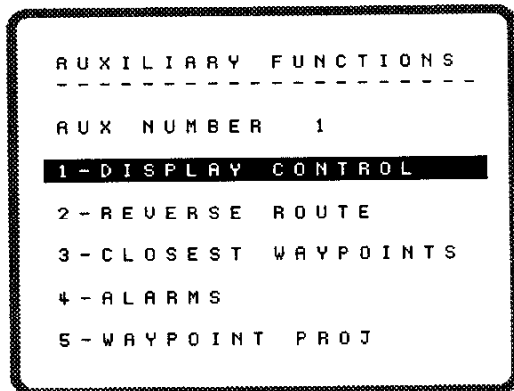

This chapter is arranged in numerical order; for your convenience, a table at the end of the chapter arranges the functions in alphabetical order.

39

AUX 1 — DISPLAY CONTROL

The Display Control function allows you to change the brightness and contrast of the display.

Select AUX 1, then press **LIGHT** to backlight the display. Use the **DOWN ARROW** to highlight the desired feature, and the **RIGHT/LEFT ARROWS** to change the value.

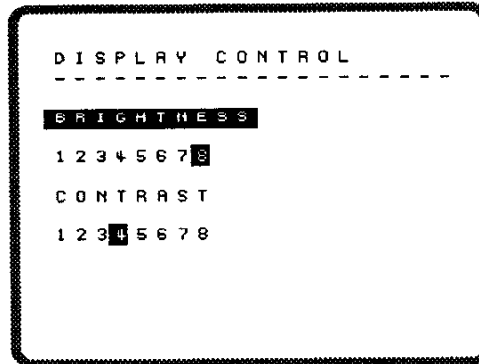

The possible levels of brightness and contrast are 1 through 8. The default setting for brightness is 8; the default setting for contrast is 4. Once changed, the selected values are retained until changed again or the unit's memory is cleared or lost.

AUX 2 — REVERSE ROUTE

Reverse route allows you reverse the order of all waypoints in any selected route (including the Go-To route). When a route has been reversed, the starting waypoint for the first leg becomes the destination waypoint for the final leg of the reversed route; the destination waypoint for the final leg becomes the starting waypoint for the first leg. This means that you can navigate an outbound route, reverse it, and navigate back without having to manually enter a separate inbound route.

Access AUX 2. Press the **DOWN ARROW** to highlight the route to be reversed and press **ENTER**.

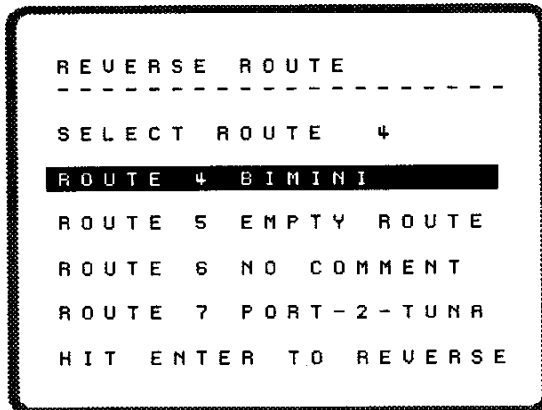

d2

AUX 3 — NEAREST WAYPOINTS

This function calculates and displays the 10 waypoints that are the closest to your current position or other selected location.

Access AUX 3. The first location displayed is POS. To select another location, key in all or part of a waypoint name or use the **RIGHT/LEFT ARROW** to select a waypoint. When the desired location is displayed, highlight GO and press **ENTER**.

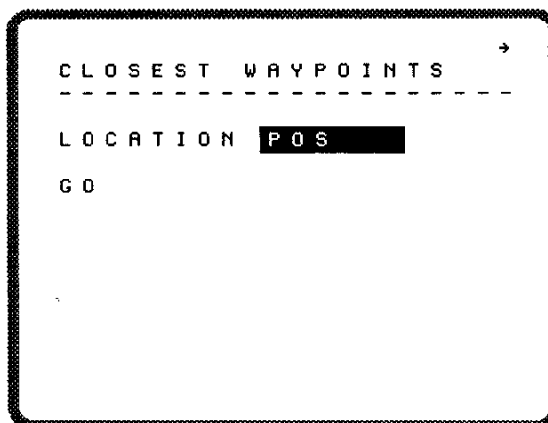

d5

The unit calculates and displays the ten waypoints that are closest to the selected location. The waypoints are displayed in order of distance from the location, with the nearest waypoint first.

CLOSEST WAYPOINTS		
MARLIN	1.2 Nm	320°
TUNR	1.3 Nm	319°
SLIP	2.1 Nm	180°
HARBOR	4.2 Nm	90°

AUX 4 — ALARMS

The NAV 5200DX has an anchor alarm, an arrival alarm, and an XTE alarm. If AUX 4 has been turned on, each alarm causes an external beeper to sound when the vessel moves a pre-set distance from a specific location, destination, or course.

NOTE

We highly recommend that the unit be connected to a beeper or other alarm mechanism that is **external** to the NAV 5200DX. Although the unit's internal beeper will sound when alarm conditions are met (even if the internal beeper has been turned off with AUX 7), the internal beeper will probably not be loud enough to attract your attention if you are not near the unit at the time. Refer to *Connecting to an External Alarm* in Chapter 2.

The anchor alarm is sounded when the vessel leaves a user-defined radius around a specific location. The location is always the current position at the time the alarm is set; the radius is entered by the user.

The arrival alarm is sounded when the vessel enters the arrival circle (when the unit displays the CLOSE message). The arrival circle is a 500-foot circle about the destination waypoint, and cannot be redefined. The alarm will not sound when you pass the destination waypoint without entering the arrival circle.

The XTE alarm sounds when the vessel deviates a user-entered distance from the courseline. It can be set to any value except "0."

All of the alarms are reset to off when the unit is turned off.

To set the anchor alarm, highlight ANCHOR ALARM, then press the **RIGHT ARROW** to turn the alarm on and off. As soon as the anchor alarm is turned on, the anchor icon (⚓) appears on the first line. This icon is displayed on all screens when the anchor alarm is on.

waypoint of x is created and

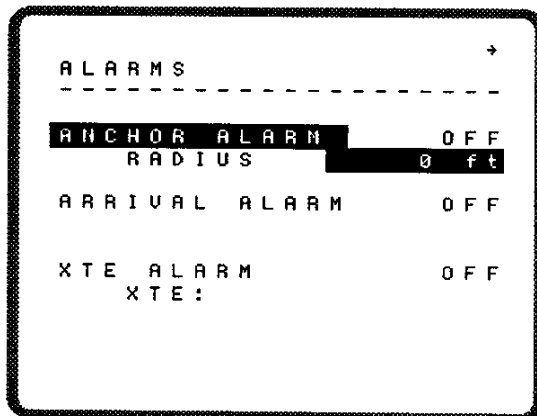

49

50

 **WARNING**

The anchor alarm also sounds when the unit has been unable to compute or update the position for 1 minute.

The unit assumes that the current position at the time the anchor alarm is turned on is the position you want to hold. Therefore, the current position is always saved as waypoint anchor; this cannot be changed.

Waypoint anchor can be accessed in the waypoint catalog, but cannot be used in any route unless it is copied to another name. It will be overwritten with new coordinates the next time the anchor alarm is set.

Press **ENTER** or the **DOWN ARROW** to highlight **RADIUS**. Enter the distance at which you want the alarm to sound. (The unit of measure displayed is feet or meters, as selected for elevation units in **SETUP**.) Press **NAV**.

NOTE

We recommend entering a value that is no less than 328 feet (100 meters) when you are not receiving DGPS corrections; this will allow you to compensate for the effects of SA. If you are receiving DGPS corrections, a good minimum distance is about 98 feet (30 meters).

To turn the arrival alarm on, press **ENTER** or the **DOWN ARROW** to highlight **ARRIVAL ALARM**, then press the **RIGHT ARROW** to turn the alarm on and off.

The XTE alarm is set by highlighting **XTE ALARM** and pressing the **RIGHT ARROW** to turn the alarm on and off. Press **ENTER** or the **DOWN ARROW** to highlight **XTE**: and enter the distance from the course line at which the alarm will sound.

When the arrival alarm and/or the XTE alarm has been turned on, the symbol  appears on all navigation displays. It is below the CDI (at 0.0) on Nav1 and Nav2, and between "POS" and "CURSOR" on Nav3.

AUX 5 — WAYPOINT PROJECTION

Waypoint projection calculates the latitude and longitude of a remote location, given the distance and bearing of the location from a known position.

Access AUX 5. The unit displays POS as the known position. To use a waypoint, press the **RIGHT/LEFT ARROW** or enter all or part of the waypoint name. Press **ENTER** when the desired position is displayed. Next, enter the distance from the known position to the remote location and press **ENTER**. Key in bearing to the remote position followed by **ENTER**. Select GO and press **ENTER** when all entries are complete.

The unit calculates and displays the coordinates of the projected waypoint. To save this position, press **ENTER** and key in a waypoint name.

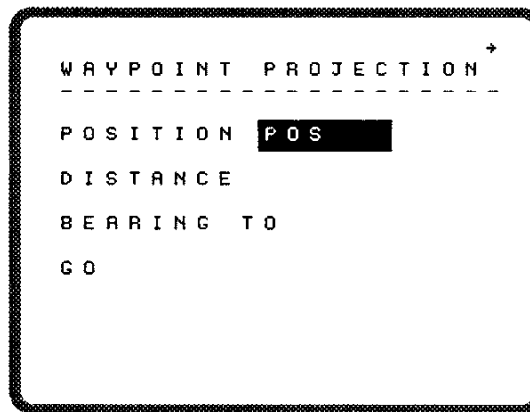

AUX 6 — TRIP VMG

The trip VMG calculates and displays the VMG for the current route and the time elapsed since the function was turned on. Distance is displayed in the unit of measure selected with AUX 7.

To start the trip VMG, access AUX 6. Press the **RIGHT ARROW** to highlight START and press **ENTER**.

Stop the trip VMG by selecting AUX 6, highlighting STOP, and pressing **ENTER**.

The trip VMG can be restarted without resetting the displayed values by selecting CONT.

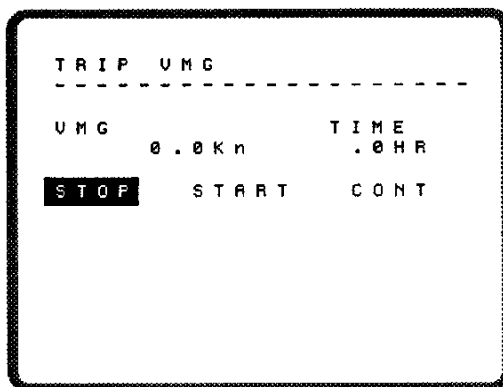

50

AUX 7 — SETUP

AUX 7 is used to initialize the unit before it is used for the first time or when it has been moved more than 300 miles (482.7 km) from where the last fix was taken. (Although it is possible to get a position fix without an initial position, the unit performs better when it has been initialized.) AUX 7 is also used to modify the unit's operating configuration.

Values are changed by pressing AUX, 7, and ENTER, then using the UP ARROW and the DOWN ARROW to scroll through the setup features, the RIGHT ARROW and the LEFT ARROW to change features, or the keypad to enter new values.

NOTE

When you change a feature with AUX 7, all related displays are affected. For example, once a coordinate format is chosen, that system appears in the current position, way-points, and initial position.

Display Language. All NAV 5200DX displays can be shown in English, French, German, Spanish, or Italian. The default language is English. Once a different language is chosen, all screen displays will be in the selected language.

Select AUX 7. The first item in the SETUP menu is LANGUAGES. Press **ENTER** to change the display language, then use the **RIGHT ARROW** to select a different language. Press **ENTER** when the desired language is highlighted.

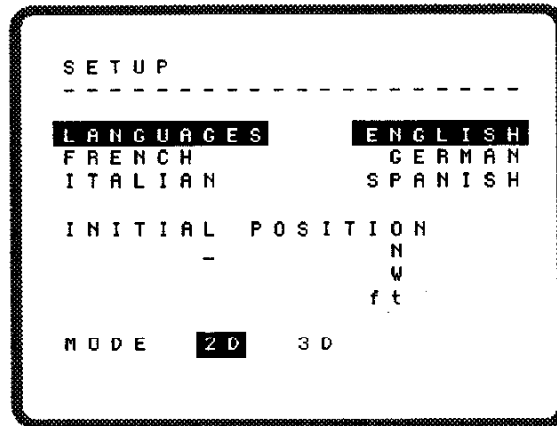

The display will remain in the previously selected language until another function is selected or until you scroll to the next SETUP feature.

All screens will be shown in the display language selected until another language is selected or the unit's memory is lost or cleared.

Entering an Initial Position. The initial position entered here must be correct within 300 miles (487.2 km). This will ensure more accurate position fixes and will prevent initialization errors from occurring (see *Initialization Error*). If you are not sure of your position, call your local marine electronics dealer or consult an atlas or chart.

The unit should be re-initialized if it is moved more than 300 miles (487.2 km) from the last position fix or suffers a memory loss.

The NAV 5200DX can display degrees/minutes (34°06.56 N) or degrees/minutes/seconds (34°06'34 N). If the unit is being initialized before its first use or after a memory loss or if the non-default parameters have been cleared, the unit will default to degrees/minutes. The unit will not accept coordinates unless they are entered in the selected format.

Press the **DOWN ARROW** to highlight INITIAL POSITION. Press the **RIGHT ARROW** to highlight latitude. If a position is displayed, you can erase it by pressing **CLEAR** or by entering the first number of the new position; the old position will disappear. Use the **RIGHT ARROW** as necessary to toggle between N and S after the values for latitude have been keyed in.

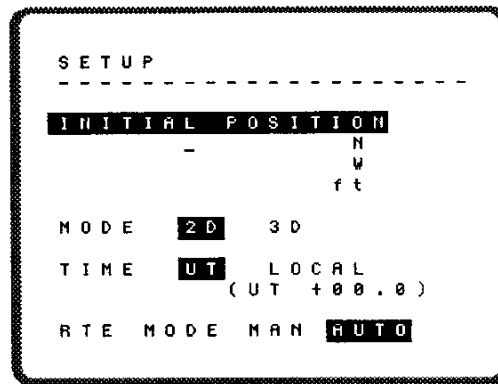

5/2

NOTE

The default hemispheres (before initialization or after memory loss) are North and West. The unit assumes that the hemispheres you choose here (or the hemispheres calculated in the last fix, whichever is more recent) are current. These hemispheres are offered as your first choice when you enter a waypoint manually.

Press **ENTER** to save the value entered and to highlight the next line. Enter the longitude, using the **RIGHT ARROW** to toggle between E and W.

Press **ENTER** and key in your current antenna elevation. Use the **RIGHT ARROW** or the **LEFT ARROW** to toggle between positive and negative elevations (above or below sea level). Press **ENTER**.

NOTE

Failure to complete this step will cause the unit to use the default elevation of 0 feet, which may prevent the unit from obtaining the best accuracies possible.

Antenna elevation is the sum of the elevation of your current position plus the height of the antenna installation above you. An accurate (within 5 meters) elevation must be entered, regardless of the mode (2D or 3D) you select.

NOTE

The unit can accept elevations up to 57,415 feet (17,500 meters).

If you prefer to use meters instead of feet, the unit of measure is defined later in AUX 7. The NAV 5200DX recalculates the stored elevations when the unit of measure is changed. If you know your elevation in feet, go ahead and enter it now.

Selecting a Mode. The NAV 5200DX has two modes of operation. The default mode is 2D, which uses three satellites to calculate latitude and longitude and displays a user-entered value for elevation; 2D is used primarily at sea. The 3D mode uses four satellites to calculate latitude, longitude, and elevation; it is used primarily on land.

Use the **DOWN ARROW** to highlight MODE, then use the **RIGHT/LEFT ARROW** to highlight 2D or 3D.

SETUP WORKSHEET

SELECT ONE OPTION FOR EACH SETUP FEATURE

(Factory defaults are shown in bold)

- DISPLAY LANGUAGE**
- English**
 - German
 - Spanish
 - French
 - Italian

- INITIAL POSITION**
- Latitude _____
- Longitude _____
- Elevation _____

- MODE**
- 2D**
 - 3D

- TIME DISPLAY**
- UT (Universal Coordinate Time)**
 - LOCAL (AM/PM)

- ROUTE MODE**
- Automatic**
 - Manual

- VELOCITY AVERAGE**
- NONE**
 - 20 SECOND
 - 120 SECONDS

- DGPS**
- OFF**
 - Port 1
 - Port 2

- NAV2 (A)**
- DMG
 - ETA**
 - TTG
 - STR
 - VMG
 - XTE
 - SOA

- NAV2 (B)**
- DMG
 - ETA
 - TTG
 - STR
 - VMG**
 - XTE
 - SOA

LAT/LON DISPLAY

DEG/MIN

MAGNETIC VARIATION

DEG/MIN/SEC

AUTO MAG (M)

SET (USER SET - U)

___°___ E or W (Specify)

TRUE (T)

DISTANCE/SPEED UNITS

NM (nautical miles and knots)

Km (kilometers) and Kph (kilometers per hour)

MI (statute miles) and Mph (miles per hour)

ELEVATION UNITS

feet

meters

DATE ORDER

MONTH/DAY/YEAR

DAY/MONTH/YEAR

INTERNAL BEEPER

ON

OFF

PLOT TRACK

OFF

5 min

20 min

1 hr

24 hr

PLOT PRIORITY

BOAT

CURSOR

ROUTE

MAP DATUMS

WGS84

USER

MAUI

AUSTR

OAHU

EUROP

KAUAI

NAD27

TOKYO

ALASK

WGS72

Setting the Time. The GPS satellites operate on Universal Coordinate Time (formerly Greenwich Mean Time), which is the time and date that is current at the Prime Meridian, which runs near Greenwich, England. The unit abbreviates universal coordinate time as UT.

The unit collects the current time (UT) from the GPS satellites when it collects or refreshes its almanac. It is therefore unnecessary to set the time if you want to operate in UT.

If you prefer, the unit can operate with local time on a 12-hour (AM/PM) clock. (A 24-hour clock is not available.)

Highlight TIME, and use the **RIGHT/LEFT ARROW** to highlight UT or LOCAL.

If LOCAL is selected, you must enter an offset from UT. To calculate the offset, convert local time to a 24-hour clock. Next, determine if local time is ahead of or behind UT. For example, if UT is 15:00 and local time is 8:00, the offset is -7:00. If UT is 11:00 and local time is 13:00, the offset is +2:00. Key in the values for the offset, then use the **RIGHT ARROW** to select +/-.

Choosing Automatic or Manual Route Modes. Which route mode is selected here determines how the unit switches legs when navigating on a route.

With both modes, the unit constantly updates the navigation screens to reference your present position to the current leg's destination waypoint. It also displays a "CLOSE" message when you are within 500 feet (152.4 meters) of the destination waypoint.

In the automatic route mode, the unit switches from the current leg to the next when you cross an imaginary line that runs through the destination waypoint and is perpendicular to the courseline. (Refer to the illustration below.) All navigation information is now referenced to the destination waypoint of the new leg.

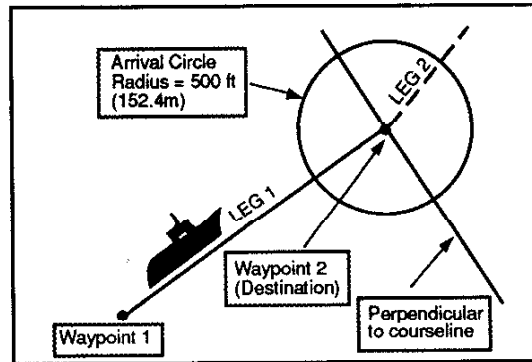

Figure 5-1. The Route Leg

In the manual route mode, the unit does not switch legs. Instead, "ARRIVED" is displayed at the bottom of Nav2, and the unit continues to compute navigation information referenced to the destination waypoint you just passed. You must switch to the next manually, by displaying the current route with ROUTE and using the DOWN ARROW to select the next leg. Press NAV to continue navigation.

To select a route mode, use the RIGHT/LEFT ARROW to select the desired route mode.

Velocity Average. Velocity-related values (such as VMG and SOG) are based on an instantaneous measurement of speed (velocity). In practice, the instantaneous nature of the velocity measurement makes the values based on it vulnerable to momentary fluctuations in velocity. The measurements appear to vary from one moment to the next, sometimes considerably.

The velocity average feature allows you to replace the instantaneous measurement with a weighted average, taken over a selected number of seconds. This has the effect of "smoothing" and stabilizing the values displayed on the screen.

Averaging can be set to none, 20 seconds, and 120 seconds.



To select a velocity average, use the **RIGHT/LEFT ARROW** to highlight the desired setting.

Differential Corrections. This feature enables the NAV5200DX to receive broadcast differential corrections in the RTCM SC-104 format.

To accept differential corrections, press the **RIGHT ARROW** to highlight Port 1 or Port 2. Be sure to select the dataport that is connected to your DBR. The unit will look for differential input until this feature is turned off (by selecting OFF) or until the unit is turned off.

This feature is automatically turned off when the unit is turned off.

Nav2(A). Nav2(A) selects the first of the two user-selected variables that are displayed on the Nav2 screen. The default is ETA.

Press the **DOWN ARROW** to highlight NAV2(A). Press the **RIGHT ARROW** to select DMG, VMG, ETA, XTE, TTG, SOA, or STR.

Nav2(B). Nav2(B) selects the second of the two user-selected variables that are displayed on the Nav2 screen. The default is VMG.

Press the **DOWN ARROW** to highlight NAV2(B). Press the **RIGHT ARROW** to select DMG, VMG, ETA, XTE, TTG, SOA, or STR.

Lat/Lon Display. The Lat/Lon coordinates can be displayed as degrees and minutes of degrees (DEG/MIN) or degrees/minutes/seconds (DEG/MIN/SEC). The difference is in how fractions of a minute are displayed.

In degrees/minutes fractions of a minute are displayed as a decimal value. (This is the default.) In degrees/minutes/seconds, fractions of a minute are displayed as seconds, with 60 seconds to a minute. The following shows the same position expressed in both formats.



DEG/MIN	DEG/MIN/SEC
34°06.58 ³ N	34°06'35N
117°49.61 ^{52.7} W	117°49'34W

To change the Lat/Lon display format, highlight LAT/LON DISPLAY, then press the **RIGHT ARROW** to highlight the desired format.

Magnetic Variation. The heading and bearing of all displays and entries can be displayed in three ways:

- Auto (M) Includes an automatic adjustment for variation by the NAV 5200DX (default).
- True (T) No magnetic adjustment is displayed.
- Set (U) A constant user-entered adjustment is displayed.

The abbreviations M, T, and U are displayed when viewing a route or using Waypoint Projection.

Highlight MAGNETIC VARIATION, then press the **RIGHT ARROW** to highlight the desired variation type. If you select SET, you must enter a variation. Key in the values, then press the **RIGHT ARROW** to toggle between E and W.

Distance/Speed Units. This feature selects the unit of measure that will be used to show distance and speed.

Highlight DISTANCE/SPEED UNITS, then press the **RIGHT ARROW** to select Mi/MPH, Nm/Kn, or Km/KPH. (Some screens display MPH and KPH as Mp and Kp respectively.)

Elevation Units. Elevation units refers to the unit of measure that will be used to display elevation above sea level.

Highlight ELEVATION UNITS, then press the **RIGHT ARROW** to select FEET or METERS.

The unit of measure selected here will also be used in AUX 4 to set anchor alarm radius.

Date Order. Use this feature to change the month/day order of displayed dates.

Highlight DATE ORDER, then use the **ARROWS** to select month/day/year or day/month/year.

Internal Beeper. The NAV 5200DX has an internal beeper that sounds when any key on the keypad is pressed and when the SQ, GQ, and Old Data symbols are displayed.

To turn the internal beeper on, select INTERNAL BEEPER and highlight YES. Highlight NO to turn the beeper off.

Plot Track. The NAV 5200DX can show your actual course of travel over a given length of time on the Nav3 (plotter) display. This is the track. The unit can be set to plot and display your track for the last 5 minutes, 20 minutes, 1 hour, or 24 hours. (Plot track is described in *Navigation (NAV), Nav3.*)

To plot your track, highlight PLOT TRACK. Press the **RIGHT ARROW** to select how much of your track will be computed and displayed.

Plot Priority. The Nav3 display (plotter) displays a boat icon at the current position, an optional cursor at a user-selected position, and the current route leg. At times these three features are too distant from each other to be shown on the same display. When this occurs, the unit displays a selected feature at the center of the screen; if another feature is near enough to be displayed also, it will also be shown.

The feature that is centered on the screen has priority over the other two. Which feature has priority is selected by the user with AUX 7 or while viewing the Nav3 display. (Refer to *Navigation — NAV, Nav3.*)

When priority is given to the boat icon (the current position), the Nav3 display keeps the current position at the center of the display. If a cursor is displayed and has priority, the cursor is at the center. When route has priority, the middle of the current leg is displayed at the center of the screen.

Cursor can be selected only when the Nav3 cursor is on. Priority returns to boat when the cursor is turned off.

Highlight **DISPLAY PRIORITY**, then press the **RIGHT ARROW** to highlight the desired feature. (Default is the boat icon.)

NOTE

Plot priority can also be changed with Nav3. Any change made at the Nav3 display will change the setting in **SETUP**.

Map Datums. The NAV 5200DX provides 11 geodetic map datums for use with charts and maps worldwide. The unit also allows you to enter manually any map datum into the unit's memory.

A datum refers to a mathematical model of the earth. Each model (datum) is based on a different set of measurements and mathematical assumptions. This means that the latitude and longitude of a position differs from one datum to another by as much as 1,968.5 feet (600 meters). It is therefore important to know which map datum you will be using to relate position information calculated by the unit to a chart. (Datums are described in more detail in *Appendix 3*.)

The map datum feature allows you to operate the NAV 5200DX on a datum that corresponds to the charts you are using. Which datum your chart uses can usually be found the legend.

Highlight **MAP DATUM**, then press the **RIGHT ARROW** to select the desired datum.

If the datum you need is not listed, select USER. When USER is highlighted, blanks appear for five constants. (Refer to *Appendix 4* for the constants needed to convert WGS84 to local datums.) Press **ENTER** and key in the value for Δa . Press **ENTER**. Key in a value for Δf and press **ENTER**. Repeat until a value has been entered for all five constants.

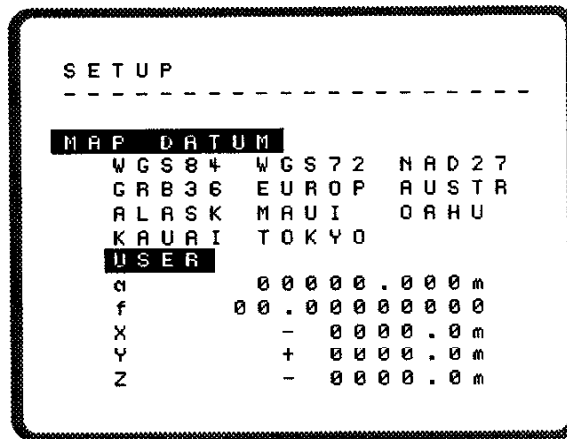

AUX 8 — SATELLITE STATUS

Satellite Status (referred to as Sat Status throughout this guide) provides specific information on the satellites. Sat Status provides the information:

- which satellites are listed as being healthy by the GPS system operators.
- the elevation and azimuth of the satellites that are above the horizon.
- satellites with weak SQs or set temporarily unusable by the GPS system operators.
- the current status of every satellite in the system.

The satellite status display includes one of the following messages:

- ON: the satellite is operating and is healthy.
- TEMP OFF: the unit is temporarily ignoring this satellite. Usually a satellite is being ignored because, after three tries, the unit was unable to find it. This happens when a satellite is hidden from view by buildings or other large obstacles. The satellite will be temporarily off for 10 minutes, or until the unit is turned off and back on.
- OFF: the unit has been instructed to ignore this satellite by the user, perhaps because its SQ is very low. The satellite remains off until the user turns it back on.

Satellites that are listed in the almanac as being unhealthy by the GPS system operators are not listed in Sat Status. Satellites are identified by a pseudorange number (PRN), which is used by the government to identify the satellites.

Access AUX 8. The first position displayed is POS. To select another position, use the **RIGHT/LEFT ARROW** or key in all or part of a waypoint name. Press **ENTER** when the desired position is displayed.

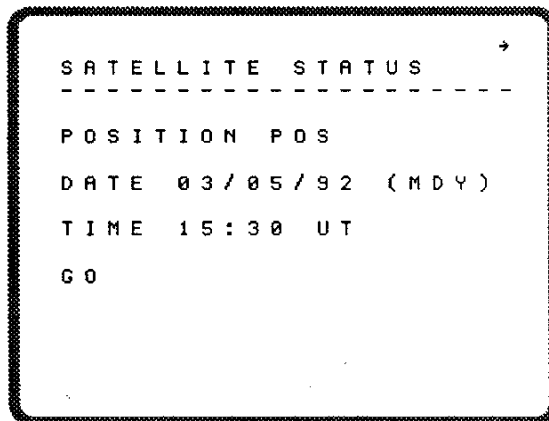

58

The unit calculates and displays the current date and time. If you prefer, you may key in a different date and time now. When all entries are complete, highlight GO and press **ENTER**.

NOTE

You may enter any date that is within 6 months of the date on which you last collected an almanac or used the unit (with the receiver on) for 15 minutes or more.

The unit displays a list of healthy satellites and their current status. For satellites that are above the horizon (as viewed from the position, at the date and time entered above), elevation and azimuth are shown.

Additional information is displayed if the unit has ephemeris data for a satellite. The SQ is shown next to the satellite status. Also, an "*" is displayed if the satellite is being used in a position solution.

All Sat Status acquisition information is displayed in real time; the screen will change as the data is updated.

S A T E L L I T E S T A T U S			
SAT	EL	AZ	STATUS
02	27°1'	088°	ON 7*
03			
06			
11	5°32'0"		ON 8*
12			
13			
14			
15			
16			
17			
18			
19			

AUX 9 — NMEA OUTPUT

If you will be supporting an NMEA device with the NAV 5200DX, the unit's dataport must be turned on and set to an output message format that can be received by the device.

Consult your autopilot, plotter, or radar manual for instructions on how to connect to the NAV 5200DX correctly, and to see what message format is appropriate. Also refer to *Installing the Data Cable* in Chapter 2.

Use the **UP/DOWN ARROW** to select ports, and the **RIGHT/LEFT ARROW** to select the output message format or to turn a port off.

N M E A		

PORT 1	OFF	0183A
0183B	0183C	0180
PORT 2	OFF	0183A
0183B	0183C	0180

The NAV 5200DX supports the following NMEA messages:

- 0180
- 0183A — BWC, APA, GLL, VTG
- 0183B — RMC, RMB
- 0183C — BWC, XTE, GLL, VTG

AUX 10 — SATELLITE SCHEDULE

Satellite schedule shows how many and which satellites will be visible at a user-selected location on a user-specified day and time. The schedule is computed for the currently selected mode of operation.

Unless the unit is being operated in a polar region, there should always be enough satellites available to obtain a 2D position fix. This feature is primarily helpful when operating in 3D, which requires the use of four satellites. Until all of the GPS satellites are in orbit, there may be periods when 3D coverage is not available at a given location.

When AUX 10 is accessed, POS is the first position offered; to select another location, press the **RIGHT ARROW** or key in all or part of the waypoint name. Press **ENTER** when the desired location is displayed.

The unit defaults to the current date. To select another date, highlight DATE and key in a new month, day, and year. Press **ENTER**.

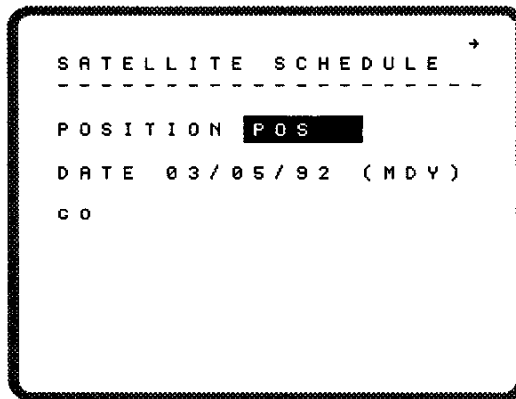

Highlight GO and press **ENTER**.

The unit computes satellite availability for the location and date selected, and displays a chart of satellite availability for both 2D and 3D operation. The charts show windows of availability as a heavy line above the time of day. Blank areas indicate that there will be insufficient visible satellites for operation.

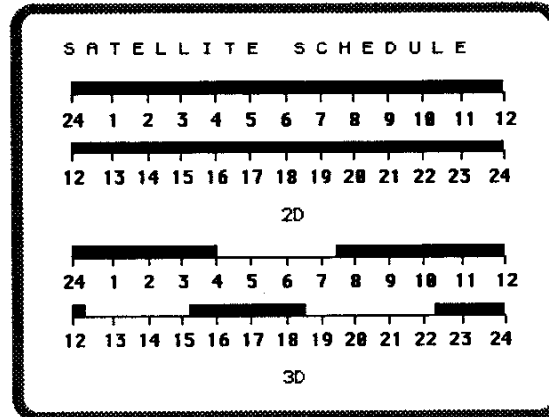

69

AUX 11 — SKY SEARCH

Sky Search is a random search for satellites from all channels that is conducted when the unit has lost all memory or does not have an almanac. Sky Search is entered with AUX 11, but is also initiated automatically when POS or NAV is pressed and the unit does not have an almanac.

In Sky Search, the unit follows a prescribed search hierarchy on all five channels to search the sky for satellites. When a satellite is located the unit collects an almanac from it and then locates other satellites to obtain a position fix. (If you do not have an initial position when you enter Sky Search, the unit calculates one and self-initializes.)

Sky Search is not initiated immediately when AUX 11 is accessed.

Press **ENTER** again to initiate Sky Search. The current status of the receiver is displayed at the bottom of the screen. This allows you to monitor the activity of all five channels throughout Sky Search and almanac collection. The unit also displays the receiver status on the first line; "SKY SEARCH" is shown while the unit searches for satellites.

```
SKY SEARCH / ALMANAC
-----
PRESS ENTER
TO CONTINUE
```

63

The unit remains in Sky Search until a satellite is found and acquired (ephemeris data is collected from it). The unit then collects an almanac from the satellite on one channel while the remaining four channels continue to search for additional satellites. "ALM COLLECT" is displayed on the first line during almanac collection. Do **not** turn the unit off while this message is displayed.

```
SKY SEARCH
SKY SEARCH / ALMANAC
-----

SAT 11 13 15 17 19
SQ  S  S  S  S  S
```

64

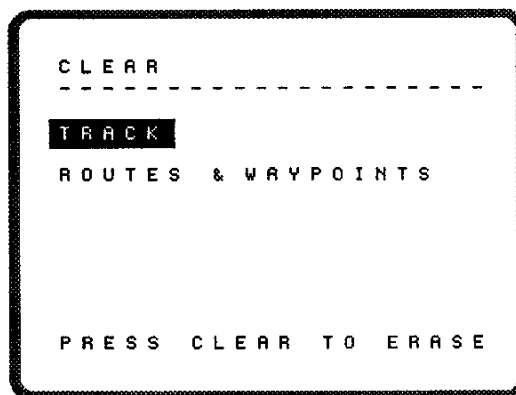

AUX 13 — CLEAR MEMORY

Clear Memory erases all or selected portions of the unit's memory. Before using this function be very sure that this is what you really want to do.

NOTE

Clear Memory can be accessed only by pressing AUX 13. It does not appear if you scroll through the Auxiliary Functions with the DOWN ARROW.

You may select:

- ALL – to erase **everything** in the unit's memory
- USER DATUM – to erase a user-entered datum
- SETUP – FACTORY DEFAULT – erases all non-default setup parameters that were entered with AUX 7; the unit will return to factory-set defaults
- WAYPOINTS/ROUTES – to erase all waypoints and routes
- ALMANAC/EPHEM – to erase the almanac and an ephemeris data the unit may have collected recently
- INITIAL POSITION – to erase the initial position.

Access AUX 13. Use the **DOWN ARROW** to highlight the area you want to delete. Press **CLEAR**; the unit displays "PRESS CLEAR AGAIN." Press any key (other than **CLEAR**) to abort. Press **CLEAR** to erase everything in the highlighted area.

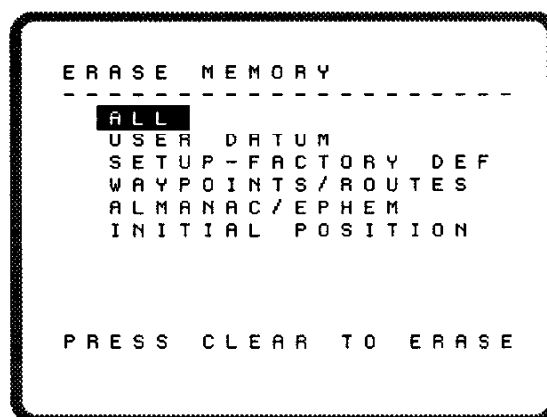

The last line of the screen displays **CLEARED** when the highlighted option has been erased. Select another area and press **CLEAR** again, or exit AUX 13 by turning the unit off.

The following table is an alphabetical list and brief description of the Auxiliary Functions. It is not intended to replace the descriptions earlier in this chapters, but only to provide a quick reference.

Auxiliary	Code (AUX +)	Page	Description/Function
Alarms	4	5-4	Turns on an external anchor alarm or an external destination/XTE alarm.
Clear Memory	13	5-28	Deletes all or selected areas of the unit's memory.

Auxiliary	Code (AUX +)	Page	Description/Function
Clear WPT/Routes	12	5-27	Deletes all waypoints/routes or all routes.
Display Control	1	5-2	Controls the brightness and contrast of the unit's display.
Nearest Waypoints	3	5-3	Computes and displays the 10 waypoints that are closest to your present position.
NMEA Setup	9	5-23	Selects the output message format for supported NMEA devices and turns on the dataports.
Reverse Route	2	5-2	Reverses the order of all waypoints in the selected route.
Sat Schedule	10	5-23	Calculates the window of availability for the location and date entered.
Sat Status	8	5-20	Computes the azimuth and elevation of satellites for the location, date, and time entered; also displays satellite status.
Setup	7	5-8	Initializes the unit; displays and changes operating parameters including display language selection.

Auxiliary	Code (AUX +)	Page	Description/Function
Sky Search	11	5-25	Searches for satellites in a prescribed hierarchy to collect an almanac and determine position after a total memory loss. Also accessed with POS after memory loss.
Trip VMG	6	5-7	Calculates and displays a cumulative VMG as you navigate on a route. Also displays time elapsed.
Waypoint Projection	5	5-6	Estimates the latitude and longitude of a distant position, based on the estimated distance and bearing from POS or a selected waypoint.

Chapter 6

TROUBLESHOOTING AND OPERATING TIPS

This chapter contains the miscellaneous information you will require to interpret the error/warning messages, troubleshoot operating problems, and prepare the unit for long-term storage.

ERROR AND WARNING MESSAGES

Error and warning messages are displayed to alert you to a condition you need to be aware of. Most messages require a response or action on your part. A few are informative only.

MESSAGE	DESCRIPTION/SOLUTION
---------	----------------------



Old data: The unit has lost contact with one or more of the satellites used for the previous fix and cannot find another available satellite. The position fix displayed with this symbol is 10 seconds old or older, and should not be used to navigate.

Try this:

- 1. Press POS to monitor receiver activity. Also check Sat Status (AUX 8) to be sure all visible satellites are set to ON.**
- 2. Change your position slightly to see if you can give the antenna a clearer view of the sky.**
- 3. If using 3D, try 2D.**



GQ warning: The Geometric Quality of the position fix is 3 or less; the fix is not accurate, and should not be used to navigate.

Try this:

- 1. Note which satellites were used for the fix.**
- 2. Check Sat Status (AUX 8) to be sure all satellites are ON.**
- 3. Check the angle of elevation and azimuth of the visible satellites: are signals being blocked by your surroundings? Try changing your position slightly and taking another fix.**
- 4. If using 3D, try 2D.**



SQ warning: The Signal Quality of one or more satellites is 3 or less. This indicates that the signal is not strong and the unit may lose it. SQ has little effect on accuracy and is displayed for information only. This symbol appears on all screens of the affected position fix.

Try this:

Change your position or the position of the antenna. Even a slight change may be enough to allow the receiver to get a stronger signal.

**NOT ENOUGH
SATELLITES UP**

Try this:

Not enough satellites are visible to take a position fix:

If operating in 2D, there are fewer than three satellites; if operating in 3D, there are fewer than four satellites.

- 1. Make sure the antenna has a clear view of the sky.**
- 2. Check the antenna connections. They must be securely fastened.**
- 3. Verify the initial position and time (see AUX 7).**
- 4. Check Sat Status (AUX 8) to be sure all satellites are set to ON.**
- 5. Check Sat Schedule (AUX 10) to be sure enough satellites are available at this time.**
- 6. If in 3D, try using 2D.**
- 7. If none of the above works, or if the unit has not been used for more than a few minutes in the past six months, press AUX 11 to initiate Sky Search and collect a new almanac.**

OPERATING PROBLEMS

Use the table below to identify problems that arise when operating the unit.

CONDITION	DESCRIPTION/SOLUTION
<p>UNIT TURNS OFF DURING USE</p> <p>Do this:</p> <p>Do this:</p>	<p>The power cable was not firmly connected.</p> <p>Check power connections.</p> <p>External power was interrupted.</p> <p>Check the external power source for malfunctions. Also check all connections.</p>
<p>POSITION FIX DOESN'T CHANGE</p> <p>Do this:</p> <p>Do this:</p>	<p>The signal from one or more satellites has been lost; the position fix displayed is the most recent one available, and the hourglass is visible on the fourth line of the display.</p> <p>Refer to ⓧ in "Error and Warning Messages."</p> <p>Display may be frozen; keypad does not respond.</p> <p>Disconnect the unit from its power source and wait for the unit to turn off.</p>
<p>THE "D" DOES NOT APPEAR ON POSITION FIX SCREEN</p>	<p>The "D" is displayed only when the unit is receiving differential corrections and producing corrected fixes. It does not appear when the fix is old and may be replaced by the SQ warning.</p>

Do this:

- 1. Check AUX 7 to be sure the DGPS function is on.**
- 2. Check all connections.**
- 3. The differential radio beacon receiver must relay corrections at 4800 baud when an NMEA 0183 or no NMEA device is being supported, and at 1200 when an NMEA 0180 device is supported.**
- 4. Check to be sure that the differential radio beacon receiver is locked onto a DGPS beacon, receiving and demodulating data, and relaying data. Refer to the user guide for your differential radio beacon receiver.**

The satellite set being used by the unit includes one or more satellites the U.S. Coast Guard beacon is not currently tracking. The unit is therefore not receiving corrected information on all of the satellites being used for the position solution.

Do this:

- 1. Check the position screen to identify which satellites are being used.**
- 2. Use AUX 8 (Sat Status) to determine where in the sky the satellites being used are, and which satellites are furthest away from the beacon. Turn off the satellites that are the most distant and try again.**

The dataport that was turned on is not the port that is connected to the DBR.

- 1. Check the connections to verify which port was used.**
- 2. Turn on the other port and try again.**

FIXES VARY
A LOT

The position accuracy of the NAV 5200DX is affected by several variables, the most important of which is the geometric quality of the fix. Therefore, the specified accuracy of 15 meters RMS in 2D is statistical not absolute, and assumes the absence of selective availability.

Since 20 meters is approximately 0.01 minute of latitude (and 0.01 minute of longitude at the equator), it is possible to see variations as large as ± 0.03 minutes of latitude/longitude from fix to fix when conditions are good.

You can increase position fix accuracy by using differential.

If the unit is being operated near the poles, small changes in position may cause great variations in position and velocity-related data. Refer to *Using the Unit Near the Poles* later in this chapter.

NMEA DEVICE IS NOT
RESPONDING

A dataport not connected to the device was turned on, or no dataport is on.

1. Check the connections to verify which port was used during installation.

2. Turn on the dataport the device is connected to and see if the NMEA device responds.

The unit is not sending output messages in correct format.

Do this:

Refer to the device's user guide to determine the correct message format. Press AUX 9 to verify the unit's setting and change it, if necessary.

Cables and adapters are not secure or are not connected correctly.

Do this:

Check all cables and adapters; refer to the illustration on page 2-1 for proper connections.

AUTOPILOT DOES
NOT RESPOND

Refer to "NMEA Devices," above.

You are not navigating on a route.

Do this:

Set a route as described in Creating a Route.

SECOND NAV DISPLAY
DOES NOT APPEAR

The Nav2 display is available only when you are navigating on a route or the MOB route. The Nav1 and Nav3 displays are always available because they provide information that is not dependent upon a route.

Do this: **Select a route leg to navigate on.**

DASHES APPEAR IN NAV DISPLAYS

You are 65.6 feet (20 meters) or less from your destination. Distance to destination is no longer available, and bearing varies considerably. This is normal.

You must be travelling faster than 0.2 knots to get velocity-related data, such as speed over ground (SOG), course over ground (COG), steering, speed of advance (SOA) or time to go (TTG).

Try this: **Increase speed to 0.2 knots or greater.**

Navigation- and velocity-related data is not available until three fixes have been made.

Do this: **Wait until three position fixes have been taken, then try again.**

SOME VALUES IN NAV DISPLAYS ARE NOT STABLE

Certain values are calculated from an instantaneous measurement of speed. Since speed may fluctuate from one instant to another, these calculations may seem unsteady. The navigation calculations that may be affected are VMG, SOA, TTG, and ETA; the velocity calculations that may be affected are SOG and COG.

Do this: *Use Velocity Average in AUX 7 to replace the instantaneous measurement with a weighted average. Select an average of fixes over 20 seconds or 120 seconds.*

SATELLITE
AVAILABILITY NOT
TO YOUR
EXPECTATIONS

The position or health of a satellite may have been changed by the government. You may also have last collected an almanac on a day when one or more satellites were set to "unhealthy."

Do this: *Check your initialized position, time, and the satellites listed in Sat Status (AUX 8). Collect a new almanac with Sky Search, then check Sat Status again. Note if more satellites are listed now.*

You may have turned some satellites off, perhaps because they had low SQs or low elevations and you wanted the unit to ignore them.

Do this: *Check Sat Status with AUX 8. Scroll through the satellites. If any are set to OFF, reset them to ON.*

You are using 3D, which requires four satellites. Until the GPS constellation is complete, satellite coverage in some areas and at some times of day may not be sufficient to support 3D operation to your complete satisfaction.



Try this:

Check Sat Schedule with AUX 10. If the window of availability for 3D operation is insufficient, try operating in 2D.

OPERATING TIPS

General. Most equipment malfunctions can be prevented by observing the following rules:

- Turn the unit off before connecting external power.
- Do not mount the unit face in direct sunlight.
- Do not operate the unit in temperatures above 50°C or below -10°C.
- Do not store the unit at temperatures above 70°C or below -40°C.

Unsure of Your Position When Initializing. When you want to initialize the unit, but do not know your current position and have no map to refer to, allow the unit to self-initialize after power-on. You can also begin self-initialization after clearing all or part of the unit's memory by accessing AUX 11. (Be sure you have a clear view of the sky.) The unit searches the sky for any satellite and collects an almanac from it. The unit then locates additional satellites to calculate a position fix and initialize itself. An initialized position entered in this way is sufficient to operate the unit, but the unit will obtain its first position fix much faster if it is initialized by manually entering the position.

If you know where you were, you can use Waypoint Projection (AUX 5) to project your current position.

Search and Acquisition Errors. Under the following conditions, the unit may be unable to obtain a position fix:

- Initialization was not done correctly.
- Poor signal environment.
- Insufficient number of satellites.
- Unit searches constantly.



Initialization Error. An initialization error occurs when:

- The initial position entered with AUX 7 was incorrect by 300 miles (482.7 km) or more.
- The unit has been moved 300 miles (482.7 km) or more from its last position fix or initial position.

Either condition can cause the unit to be unable to find the satellites it looks for. Since the unit searches for satellites based on where it thinks it is, if the initial position or the last position fix obtained is 300 miles (482.7 km) or more away from the unit's current position, the unit may search for satellites that are not available at its true location.

Either condition can also cause the unit to calculate a position fix that is 300 miles (482.7 km) or more from its initial position or last fix. The unit regards this position fix as an error, and tries three more times to obtain a position fix that it can accept.

After the fourth attempt to obtain an acceptable position fix, the unit discards the initial position or last fix and assumes that an initialization error has occurred. The unit then re-initializes itself, using the satellites that it has already acquired. This takes between 10 and 60 seconds.

Sometimes, the initial position is so far off from the present position that the unit is unable to locate enough satellites to obtain a fix. When this happens, the unit searches until it has enough satellites to obtain a fix. You will notice the PRN numbers on the receiver status screen change periodically while the unit searches.

If the unit does not have a new position fix after about 20 minutes, either re-initialize the unit (*Initialization* in Chapter 2, or *AUX 7—SETUP*) or enter Sky Search with AUX 11 to collect a new almanac.

The Signal Environment. The signal environment refers to the physical conditions in which the unit is being operated. A poor signal environment limits the receiver's ability to locate and track satellite signals.

Poor environments include areas of dense foliage or dense construction (even a one-story building can block signals when the visible satellites have low elevations). It also includes locations with a limited view of the sky, such as a site at the base of a cliff.

Several things can alleviate the effects of a poor signal environment. One is the use of a mask angle that is appropriate to the location. The mask angle is the height (in degrees) above the horizon, below which the receiver will not search for satellites. The NAV 5200DX has a variable mask angle; the receiver starts its search with a 10° mask angle. If enough satellites for a position fix cannot be found, the search is automatically extended to 5°, then to the horizon.

There are additional ways to lessen the effects of signal environment problems. The user can make sure that the antenna has as clear a view of the sky as possible, and is not too close to possible obstructions. Setting the unit to use 2D instead of 3D often helps, since the unit will use a different satellite set for a 2D solution than it will for a 3D solution. Also, check Sat Schedule to be sure that you are using the unit when as many satellites as possible are visible to your location.

Insufficient Number of Satellites. Before searching for satellites, the NAV 5200DX checks its almanac to determine which satellites are scheduled to be in view, given the unit's last known position, and where in the sky to look for them. (Since the unit knows which satellites to look for and where they should be before the receiver is turned on, the time to first fix is greatly reduced.)

If enough satellites for a position fix are above the horizon, the receiver will turn on and the unit will start to look for them. If not enough satellites are up, the receiver remains off and the unit displays "NOT ENOUGH SATELLITES UP." The unit will ignore any satellite that has been set to "off" in Sat Status when determining satellite availability; check Sat Status and turn on any visible satellite that has been turned off, then try again.

If the unit is set to 3D operation, you may see an additional message. When only three satellites are visible, the unit will also display "TRY 2D." If you cannot get a fix by turning satellites on in Sat Status, you will be able to obtain a position fix with 2D.

Unit Searches Constantly. If the unit has an almanac and is unable to locate satellites, it searches continually until a satellite is found.

The unit may be unable to locate satellites under the following conditions:

- The antenna is not installed in a good location
- The satellite signals are blocked from view by buildings, mountains, etc.
- There are signal reflections that can be corrected by moving the antenna
- There are satellite outages
- Satellites are set to OFF in Sat Status

Refer to *AUX 8, Sat Status*, to verify satellite status. Also be sure your external antenna has an unobstructed view of the sky.

Accuracy Warning Symbol. The accuracy of a position fix is determined by the position of the satellites used relative to each other. The closer the satellites are to each other, the less accurate the fix is likely to be. This is referred to as geometric quality, and is displayed on the position screen as GQ. A GQ from 7 to 9 indicates very good satellite geometry; between 4 and 6 is good; GQs of 3 and below produce unreliable fixes.

The unit displays a warning icon (⚠) on the top line of all screens when GQ falls to 3 or less.

**WARNING**

When the accuracy warning symbol appears, do **not** use this data to navigate.

Signal Quality. The unit also measures and displays the strength of the signal it receives from the satellites. A signal quality (SQ) of 4 and above indicates a strong signal; 0 to 3 indicates a signal so weak that it may be lost.

SQ has little affect on the accuracy of the fix; it is intended only to alert you that a signal from one or more satellites is not as strong as it could be.

The unit displays a warning icon (⚠) on the top line of all screens when the SQ from one or more satellites is 3 or less. The SQ of each satellite being used in a position fix is displayed on the position screen.

Old Data. The unit automatically updates its position every second. If a satellite signal is lost (usually because a satellite sets or its signal becomes obstructed), the unit switches to other satellites to update the fix. If other satellites are not available, the unit cannot update the position fix.

The hourglass symbol (⌚) appears on the top of the display when the most recent position fix is at least 10 seconds old. The position fix is not current, and should not be used for navigating.

VARIABLE MASK ANGLES

The NAV 5200DX has a variable mask angle to improve the ability of the unit to locate and track satellites, even when some satellite signals are blocked by obstructions.

The mask angle is the elevation above the horizon (measured in degrees) below which the unit will not search for satellites. Normally the unit looks for satellites that are 10° or more above the horizon; this is a 10° mask angle. If the unit is unable to locate enough satellites to obtain a position fix with a 10° mask angle, the unit automatically goes to a 5° mask angle in order to find a satellite and obtain a position fix.

Any satellite that is found with the lower mask angle is tracked until it moves below 5° . The unit then switches to a satellite with a higher elevation to continue updating the position fix. If no other satellite is available, the unit continues tracking the original satellite until it reaches the horizon (elevation 0°).

The variable mask angle greatly improves the ability of the unit to locate and track sufficient satellites to obtain a position fix in most locations and under most conditions. You should be aware, however, that using lower elevation satellites may affect the performance of the unit. The signal from lower elevation satellites is subject to greater interference from surrounding obstructions, including water when on rough seas. Also, the signal from a lower elevation satellite must travel through more atmosphere than the signal from a satellite with a higher elevation, and is subject to more errors induced by tropospheric and ionospheric conditions.

If you have difficulty locating satellites, use AUX 8 to view Sat Status. Sat Status shows the elevation of all satellites that are above the horizon. If you are unable to locate a satellite that should be visible, its signal is probably being blocked by obstructions.

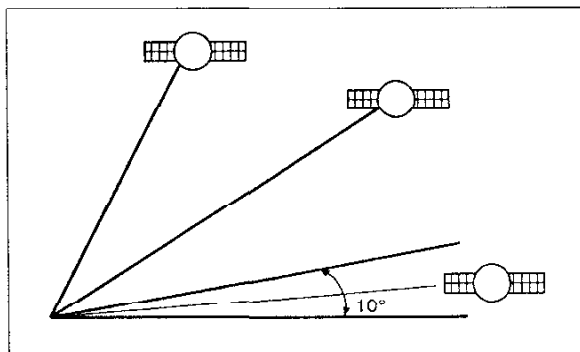

Figure 6-1. Mask Angle with Unobscured Horizon

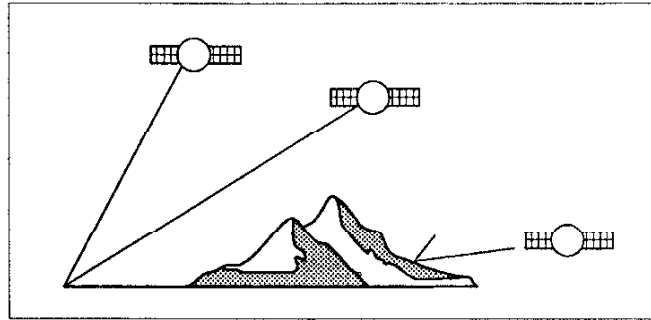

Figure 6-2. Mask Angle with Obscured Horizons

ADJUSTING THE DISPLAY

The NAV 5200DX can be backlit by pressing LIGHT on the function keypad. The display remains lit until LIGHT is pressed again or the unit is turned off.

The brightness and contrast of the display can also be adjusted. (Refer to *AUX 1 — Display Control*.) This is most easily done when the light is on.

CHOOSING A DATUM

All charts are created using a system that includes the scale, type of projection, and a map datum. There are hundreds of map datums in use throughout the world, but only a few are in widespread use today. The NAV 5200DX has 11 map datums plus one user-entered datum. You should set the unit to use the same datum as your charts and equipment; a position in one datum can differ by 300 meters or more from one calculated using another datum. (Refer to *Appendix 3* for a more technical description of datums.)

Before setting the datum with AUX 7, check the datum used by your charts (look at the legend) and the manuals for your electronic navigation equipment. If the datum you need is not available with the NAV 5200DX, set a user-entered datum. This is described in *AUX 7—Setup, Setting a User-Entered Map Datum*.

The National Oceanic and Atmospheric Administration (NOAA) is currently changing its charts to NAD83; for most purposes, this is the same as WGS84. Most NOAA charts in use now are NAD27 or NAD83. USGS maps are usually in NAD27.

USING THE UNIT NEAR THE POLES

Since all meridians of longitude converge at the North and South poles, a nautical mile can span many degrees of longitude near the poles. This means that small changes in position can cause large variations.

The inherent accuracy of the NAV 5200DX does not change near the poles, but this mathematical sensitivity problem can cause position and velocity-related data to appear unstable when the unit is operated at latitudes greater than 85° north or south of the equator. Use caution in interpreting displayed data in these areas.

Until the GPS constellation is complete, 24-hour 2D coverage may not be available in polar regions.

WHEN NOTHING ELSE WORKS

Usually, turning the unit off for a few minutes or disconnecting it from its external power source will solve a temporary glitch, such as a frozen display. Neither action affects the unit's memory.

Occasionally, this not enough. If the solutions described in *Operating Problems* do not work, try clearing all or part of the unit's memory with AUX 13. (Be sure you have recorded your waypoints and any non-default SETUP parameters before clearing the unit's memory.)

If the keypad does not respond and disconnecting the unit does not work, try pressing the system reset buttons. System reset should be used only when absolutely necessary, since

this clears **all** of the unit's memory. The system reset keys are 1, 9, and LIGHT, pressed together.

MAGELLAN'S CUSTOMER SUPPORT

Representatives are available Monday through Friday, between 8 AM and 5 PM, Pacific Standard Time at 909 - 394-5000. Faxes can be sent to 909 - 394-7050.

If necessary, you can also return your unit to Magellan for repair. (Please call Customer Support for assistance first.) If possible, please notify us before shipping the unit by Parcel Post or UPS, and include with the unit a description of the problem and your name and address. If your return shipping address is different, please include it.

Packages should be sent to:

Magellan Systems Corporation
960 Overland Court
San Dimas, California 91773
Attention: Warranty Repair