



Magellan[®] RoadMate[™] 1200



User Manual

IMPORTANT SAFETY WARNINGS

The Magellan RoadMate is a vehicle-navigation aid designed to assist you in arriving to your selected destinations. When using the Magellan RoadMate, these safety rules must be followed to prevent accidents that can result in injury or death to yourself or others:

- California and Minnesota law prohibits mounting any item to your windshield. Please check with your state or local law enforcement for applicable regulations regarding windshield mounting. Go to www.magellanGPS.com for alternate mounting solutions. An adhesive disk is supplied with the Magellan RoadMate for use as an alternate mounting solution to the dashboard.
- When driving, the need to view the display is minimal. Voice prompts will guide you to your destination. The driver should enter data or program the Magellan RoadMate only when the vehicle is stopped. Only a vehicle passenger should enter data or program the Magellan RoadMate while the vehicle is moving.
- It is your responsibility to comply with all traffic laws.
- Every attempt is made to ensure that the database is accurate. However, roadways, points of interest (POIs), and business and service locations may change over time. The database does not include, analyze, process, consider, or reflect any of the following: legal restrictions (such as vehicular type, weight, height, width, load and speed restrictions); road slope or grade; bridge height, width, weight, or other limits; population density; neighborhood quality or safety; availability or proximity of law enforcement, emergency rescue, medical, or other assistance; construction work zones or hazards; road or lane closures; road, traffic, or traffic facilities' safety or condition; weather conditions; pavement characteristics or conditions; special events; traffic congestion. It is your responsibility to disregard any unsafe, hazardous, or illegal route suggestions.
- Keep the Magellan RoadMate safe from extreme temperature conditions. For example, do not leave it exposed to direct sunlight for an extended period of time.
- Take care when mounting the Magellan RoadMate in your vehicle, whether using the windshield mount or other mount or accessories, that it does not obstruct the driver's view of the road, interfere with the operation of the vehicle's safety devices such as air bags, or present a hazard to occupants of the vehicle should the Magellan RoadMate be dislodged while driving. You assume the risks associated with damage to your vehicle or vehicle occupants as the result of your choices in mounting the Magellan RoadMate.
- Laws in some states prohibit wearing stereo headphones while operating a motor vehicle. Please contact your state's Department of Motor Vehicles for information.
- The battery in the Magellan RoadMate is rechargeable and should not be removed. In the event it should need to be replaced, please contact Magellan Technical Support.

About Charging the Magellan RoadMate

- An optional AC adapter is available as an accessory for your Magellan RoadMate. Use of another type of AC adapter can result in malfunction and/or possible fire hazard due to battery over heating.
- Use only the car charger approved for / supplied with your Magellan RoadMate. Use of another type of car charger will result in malfunction and/or damage to the receiver.
- For safety reasons, the battery in your Magellan RoadMate will stop charging when the ambient temperature is less than 32°F (0°C) or more than 113°F (45°C).
- It will take approximately 4 hours of charging the Magellan RoadMate through the cigarette lighter adapter or optional AC adapter to obtain a full battery charge.

About the Battery

- Do not attempt to replace the battery. Please contact Magellan Technical Support for issues related to the battery.
- Use the charger approved for your Magellan RoadMate.

IMPORTANT SAFETY WARNINGS

Federal Communication Commission Interference Statement

This equipment has been tested and found to comply with the limits for a Class B digital device, pursuant to Part 15 of the FCC Rules. These limits are designed to provide reasonable protection against harmful interference in a residential installation. This equipment generates, uses and can radiate radio frequency energy and, if not installed and used in accordance with the instructions, may cause harmful interference to radio communications. However, there is no guarantee that interference will not occur in a particular installation. If this equipment does cause harmful interference to radio or television reception, which can be determined by turning the equipment off and on, the user is encouraged to try to correct the interference by one of the following measures:

- -Reorient or relocate the receiving antenna.
- -Increase the separation between the equipment and receiver.
- -Connect the equipment into an outlet on a circuit different from that to which the receiver is connected.
- -Consult the dealer or an experienced radio/TV technician for help.

This device complies with Part 15 of the FCC Rules. Operation is subject to the following two conditions: (1) This device may not cause harmful interference, and (2) this device must accept any interference received, including interference that may cause undesired operation.

FCC Caution: Any changes or modifications not expressly approved by the party responsible for compliance could void the user's authority to operate this equipment.

IMPORTANT NOTE:

FCC Radiation Exposure Statement:

This equipment complies with FCC radiation exposure limits set forth for an uncontrolled environment. End users must follow the specific operating instructions for satisfying RF exposure compliance.

This transmitter must not be co-located or operating in conjunction with any other antenna or transmitter.

In order to maintain compliance with FCC regulations, shielded cables must be used with this equipment. Operation with non-approved equipment or unshielded cables is likely to result in interference to radio and TV reception. The user is cautioned that changes and modifications made to the equipment without the approval of manufacturer could void the user's authority to operate this equipment.

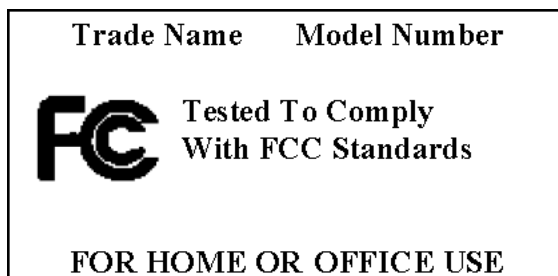

The Magellan RoadMate must be installed and operated at a distance no closer than 8 inches (20 cm) from the user.

This Class B digital apparatus meets all requirements of the Canadian Interference-Causing Equipment Regulations.

Cet appareil numérique de la classe B respecte toutes les exigences du Règlement sur le matériel brouilleur du Canada.

IMPORTANT SAFETY WARNINGS

IC statement

Operation is subject to the following two conditions:

1. This device may not cause interference and
2. This device must accept any interference, including interference that may cause undesired operation of the device.

IMPORTANT NOTE:

IC Radiation Exposure Statement:

This equipment complies with IC radiation exposure limits set forth for an uncontrolled environment. End users must follow the specific operating instructions for satisfying RF exposure compliance.

This transmitter must not be co-located or operating in conjunction with any other antenna or transmitter.

The information provided in this document is subject to change without notice. Improvements and enhancements to the product may occur without any formal notification. Check the Magellan website (www.magellanGPS) for product updates and additional information.

© 2007 Magellan Navigation, Inc. All rights reserved. The Magellan Logo, Magellan, RoadMate, TrueView, SmartDetour, and SmartVolume are trademarks of Magellan Navigation, Inc. No part of this user manual may be reproduced or transmitted in any form or by any means, electronic or mechanical, including photocopying and recording, for any purpose other than the purchaser's personal use, without the prior written permission of Magellan Navigation, Inc.

604-0043-001 A

Table of Contents

Table of Contents	1
Magellan RoadMate 1200	1
Front View	2
Side Views	2
Back View	2
Installation Instructions	3
Selecting the Location	3
Cleaning the Area	3
Applying the Adhesive Disk	3
Attach the Cradle	3
Adjustable Mount	4
Secure the Mount to the Windshield or Adhesive Disk	4
Adjust the Mount for Optimum Viewing	4
Connecting Power	4
Security	4
Region	5
Fundamentals	6
Powering on the Magellan RoadMate	6
<i>Turning the Magellan RoadMate On</i>	6
<i>Turning the Magellan RoadMate Off</i>	6
<i>Selecting Auto-Power Shutdown Time</i>	6
Volume	6
<i>Changing the Volume from the Map Screen</i>	6
<i>Changing the Volume from User Options</i>	7
Brightness	7
<i>Accessing the Brightness Control</i>	7
The Main Menu	7
<i>Accessing the Main Menu</i>	7
.Main Menu - Page 1	8
.Main Menu - Page 2	9
The Keypad	10
Keypad Overview	10
<i>Special Keys</i>	10
Selecting From List	10
Notes on Entering Data	11

Map Screen	12
<i>Accessing the Map Screen</i>	14
2D Mode	14
<i>Setting the Map Modes (2D or 3D)</i>	14
<i>Panning on the Map</i>	14
<i>Saving a Position While Panning</i>	14
<i>Routing to a Panned Position</i>	15
Current Location Screen	15
<i>Accessing the Current Location Screen</i>	15
<i>Saving Your Current Location to Your Address Book</i>	15
Maneuver List Screen	16
<i>Accessing the Maneuver List</i>	16
<i>Excluding a Maneuver</i>	16
GPS Status Screen	16
<i>Accessing the GPS Status Screen</i>	17
Zoom Levels	17
<i>Setting Zoom Levels</i>	17
Volume	17
<i>Changing the Volume from the Map Screen.</i>	17
 Home Address	 18
<i>Creating a Home Address</i>	18
<i>Creating a Route to the Home Address</i>	18
<i>Changing the Home Address</i>	18
<i>Accessing the Home Address from the Address Book</i>	19
 Current Location	 20
<i>Accessing the Current Location Screen</i>	20
<i>The Current Location Screen</i>	20
<i>Saving Your Current Location to Your Address Book</i>	21
 Enter Address	 22
Entering an Address	22
<i>Creating a Route to a New Address</i>	22
My Addresses	24
<i>Accessing the My Addresses Menu</i>	24
Previous Destinations	24
<i>Routing to a Previous Destination (Method 1)</i>	24
<i>Routing to a Previous Destination (Method 2)</i>	25
<i>Saving a Previous Destination to Your Address Book</i>	25
<i>Deleting a Previous Destination</i>	25

Address Book	26
<i>Accessing an Address in Your Address Book</i>	26
<i>Routing to an Address in Your Address Book</i>	26
<i>Editing an Address in Your Address Book.</i>	26
<i>Deleting an Address in Your Address Book.</i>	26
Favorites	26
<i>Accessing an Address from Favorites</i>	27
<i>Routing to an Address from Your Favorites List</i>	27
<i>Editing an Address from Your Favorites List</i>	27
<i>Deleting an Address from Your Favorites List</i>	27
Creating a New Entry	27
<i>Creating a New Entry to You Address Book by Selecting on the Map</i>	27
<i>Creating a New Entry to You Address Book by Entering an Address</i>	28
<i>Creating a New Entry to You Address Book from a POI</i>	28
<i>Creating a New Entry to You Address Book from by Intersections</i>	29
Intersection	29
<i>Creating a Route to Two Intersecting Streets</i>	29
Points of Interest (POI)	31
Categories and Subcategories	31
<i>Creating a Route to a POI by Category</i>	31
<i>Creating a Route to a POI by Name</i>	32
Travelling on a Route	33
Map Screen	33
Split-Screen	33
Maneuver List	33
You Have Arrived	34
Types of Routes	34
Route Method	34
Special Routing Functions	35
<i>Routing to a POI Near an Approaching Freeway Exit</i>	35
<i>Cancelling a Route</i>	35
<i>Detouring off a Route</i>	35
<i>Changing the Route Method</i>	36
Trip Planner	37
<i>Creating a Trip</i>	37
<i>Optimizing a Trip</i>	38
<i>Starting a Trip</i>	39
<i>Editing a Trip</i>	39

<i>Deleting a Trip</i>	39
<i>Renaming a Trip</i>	40
Exit POIs	41
<i>Routing to a POI Near an Approaching Freeway Exit</i>	41
User Options	42
<i>Selecting Map Region</i>	42
<i>Accessing System Settings</i>	42
<i>Checking Battery Life</i>	42
<i>Adjusting the Volume</i>	42
<i>Adjusting the Display Brightness</i>	43
<i>Setting Auto Power Off Time</i>	43
<i>Setting Time Zone</i>	43
<i>Selecting Units of Measure</i>	44
<i>Displaying Contact Us Information</i>	44
<i>Displaying Product Information</i>	44
<i>Performing Diagnostics</i>	45
<i>Accessing the Trip Computer</i>	45
<i>Selecting POIs to be Displayed on the Map</i>	46
<i>Deleting Addresses from the Address Book (Global)</i>	46
<i>Setting the Map in 3D or 2D Mode</i>	46
<i>Setting the Map Display to Heading Up or North Up</i>	47
<i>Setting Split Screen (TrueView™) Options</i>	47
<i>Setting Auto Night Map Display</i>	47
<i>Setting Detour Options</i>	48
<i>Using the Simulator</i>	48
<i>Setting Tone Options</i>	49
<i>Viewing Technical GPS Information</i>	49
<i>Setting the GPS Position</i>	49
<i>Backing Up and Restoring Data</i>	50
<i>Backing Up Data</i>	50
<i>Restoring Data</i>	50
<i>Viewing Map Information</i>	50

Magellan RoadMate 1200

The Magellan RoadMate 1200 is a vehicle navigation product that utilizes GPS signals from satellites to calculate your precise location and compute details about its travel. Knowing its position and movement, it can then overlay this information on detailed maps provided by NAVTEQ® to provide a visual representation of your location.

With the Magellan RoadMate 1200 you can:

- Store your home address and quickly get routing details to your home.
- Create and save addresses in your address book that can be accessed at any time and get routing information to that address.
- Route to an address that you enter using the keypad and Magellan's QuickSpell feature for easy, errorless entry.
- Route to any point of interest (POI) that has been preloaded into your Magellan RoadMate.
- Route to a POI that appears on the map while traveling simply by tapping on the POI icon.
- Route to an intersection by selecting the streets.
- Create a trip with multiple destinations using the trip planner. Handy for business people who need routing information to many destinations.
- View POIs that are ahead of you on the freeway. The exit POI function provides you with a list of gas stations, restaurants, hotels and auto repair shops located nearby exits you are approaching while traveling on a freeway.
- Customize your Magellan RoadMate to meet your needs using the User Options menu.

The interface for the Magellan RoadMate is easy and simple to follow once you understand the basics. You may never need to refer to this manual but if you do we have tried to present it in a form that you can access the function you are trying to complete and follow the steps provided.

The Magellan RoadMate has a built-in battery so in most cases you will be able to follow these instructions while reading them on your computer screen without plugging the Magellan RoadMate to AC power. You should note that while indoors you may not get any satellite signals so your location information would not be updated. However, the power of the SiRFstarIII™ chipset installed in the Magellan RoadMate will get satellite signals in some very rough locations so you may notice the Magellan RoadMate computing a position, even indoors.

This document is set up to be printed on 8.5" x 11" (letter) paper should you desire a printed version for your reference.

Front View

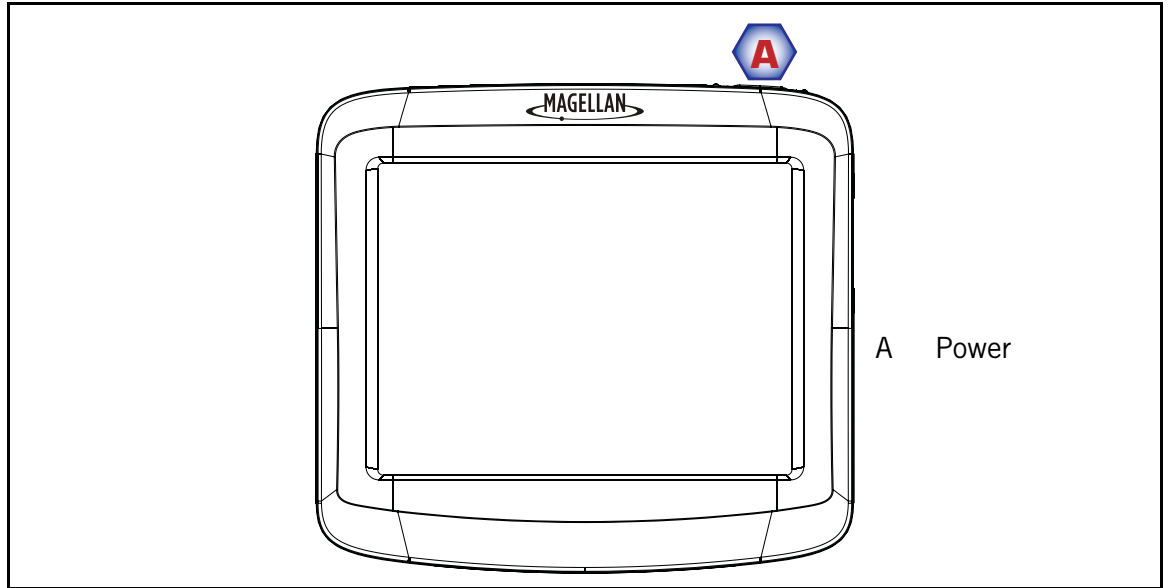

Side Views

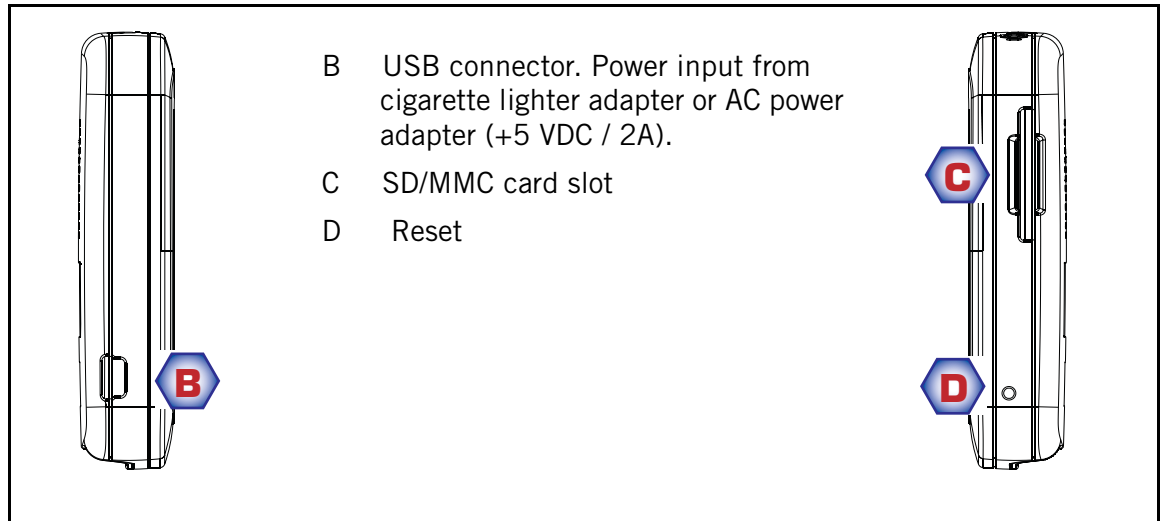

Back View

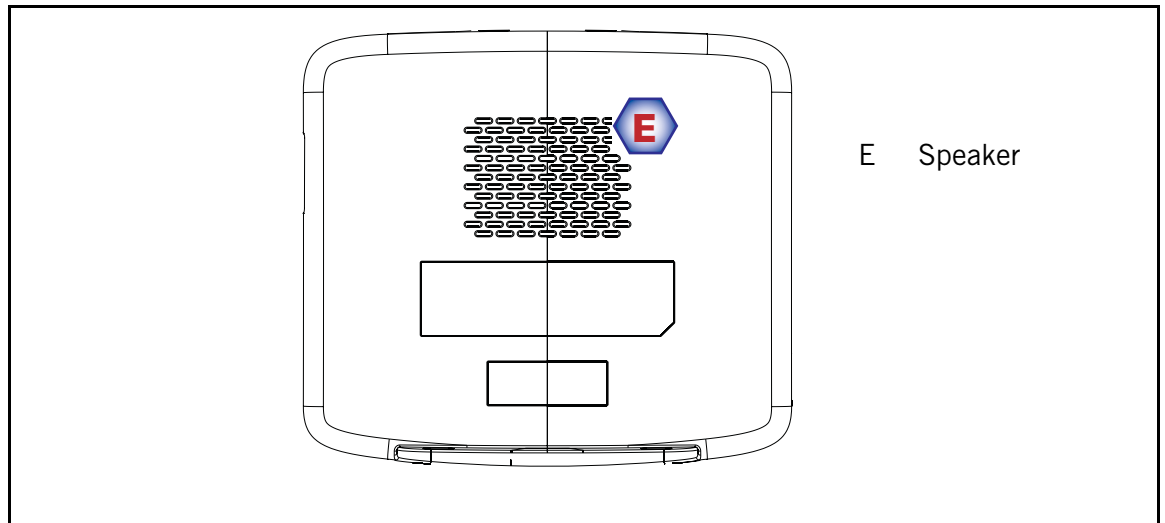

Installation Instructions

Installation of the Magellan RoadMate is simple and easy. The hardest part will be picking the best location.

Selecting the Location

A few tips on selecting the proper location.

- Mount the Magellan RoadMate in a place where it can be easily seen and will not interfere with your view of the road.
- The Magellan RoadMate should be mounted in such a way that the antenna, (located in the top of the receiver), has an unobstructed view of the sky through the windshield.
- Select whether it will be mounted using the adjustable mount to the windshield or the supplied adhesive disk. Be sure to check your local and regional laws before mounting to the windshield. Some states, like California and Minnesota, have laws restricting the mounting of any device on the windshield.
- If planning to use the adhesive disk, a smooth surface on the dash board will need to be selected. Do not attach the adhesive disk to the windshield.
- Make sure that the Magellan RoadMate or any cabling will not be disturbed in the event that the airbags are deployed.

Cleaning the Area

Use the alcohol pad that came with the Magellan RoadMate to clean the area on the windshield that has been selected for mounting the Magellan RoadMate. Let the area dry completely.

Applying the Adhesive Disk

(Skip if mounting directly to the windshield.) Remove the protective tape from the back of the adhesive disk. Apply the disk with the adhesive side towards the dash. Maintain pressure on the disk for 5 minutes to allow it to set in place. Allow the disk 24 hours to cure before continuing.

Attach the Cradle

Align the tabs on the cradle to the indents on the bottom of the Magellan RoadMate. Swivel the cradle up so that it is flush against the back of the receiver and snaps into place.



Please note that the mounting bracket supplied with the Magellan RoadMate may be different than the one shown in this document.

Adjustable Mount

Line up the two tabs on the adjustable mount with the holes on the back of the Magellan RoadMate. Once the adjustable mount is flush with the Magellan RoadMate, push the receiver down until it locks in place with the adjustable mount.



Secure the Mount to the Windshield or Adhesive Disk

Make sure that the lever at the base of the adjustable mount is in the up position. Place the base of the mount firmly over the area of the windshield to be used or the adhesive disk. Push the lever at the base of the mount all the way down until it snaps in place. Carefully let go of the assembly, making sure that it is securely mounted.

Adjust the Mount for Optimum Viewing

Loosen the adjustment locking knobs and position the Magellan RoadMate for optimum viewing. Once set, tighten the locking knobs. (Never attempt to adjust the mount while driving.)

Connecting Power

Plug the end of the cigarette lighter adapter into a 12 VDC cigarette lighter receptacle in the vehicle. Connect the other end to the Magellan RoadMate's USB connector as shown. If there is power at the receptacle, the Magellan RoadMate will power on. (Note: some vehicles apply power to the cigarette lighter receptacle only when the ignition is on.)



Security

It is recommended that the Magellan RoadMate is not left in plain view while unattended for reasons of theft.

Region

By default, the Magellan RoadMate has the region setting for the lower 48 United States. If you are travelling in Hawaii or Puerto Rico you must change the region in User Options.

- 1 From the Main Menu, tap on the right arrow to access the second page of the Main Menu.
- 2 Tap on **User Options**.
- 3 Tap on **Region**.
- 4 Tap on the map region desired.

Powering on the Magellan RoadMate

The On/Off button is located on the bottom right side of the Magellan RoadMate as shown in the Overview chapter.

Turning the Magellan RoadMate On

1. Press and hold the On/Off button for 1-2 seconds.
2. Read the Warnings and tap **OK**.

Turning the Magellan RoadMate Off

1. Press and hold the On/Off button for 1-2 seconds.

Selecting Auto-Power Shutdown Time



The Magellan RoadMate can be set up to shut down automatically using the time durations you can select. The receiver will turn off after the selected duration has passed when; A) the position hasn't changed and B) the touchscreen hasn't been pressed.

1. Access the *Main Menu*.
2. Tap the **Next** arrow to access the *Main Menu Page 2*.
3. Tap **User Options**.
4. Tap **System Settings**.
5. Tap **Power**.
6. Select Auto-Power Off time; Never, 10 Minutes, 20 Minutes or 30 Minutes.
7. Tap **Save**.
8. Tap the **Back** arrow to return to the *Main Menu*.

Volume

There are two ways to access the volume controls; one is tapping the speaker icon on the Map screen and the other is through User Options.

Changing the Volume from the Map Screen.

1. Tap the speaker icon  .
2. Tap on the Mute button to mute the volume or tap inside the volume adjust bar below the Mute button to change the volume levels.
3. Tap  .

If you have the volume muted the speaker icon is displayed with a line through it indicating it is muted. To unmute, tap the speaker icon again and the Magellan RoadMate will automatically unmute. To make any other adjustments to the volume, press the speaker icon again.

Changing the Volume from User Options

1. Access the *Main Menu*.
2. Tap the **Next** arrow to access the *Main Menu Page 2*.
3. Tap **User Options**.
4. Tap **System Settings**.
5. Tap **Volume**.
6. Tap on the Mute button to mute the volume or tap inside the volume adjust bar below the Mute button to change the volume levels.
7. Tap .

Brightness

Accessing the Brightness Control

1. Access the *Main Menu*.
2. Tap the **Next** arrow to access the *Main Menu Page 2*.
3. Tap **User Options**.
4. Tap **System Settings**.
5. Tap **Brightness**.
6. Tap inside the brightness adjust bar to set the desired brightness.
7. Tap .

On the *Brightness* screen there is a checkbox for “On-battery dimming (75%)” When checked, the Magellan RoadMate will dim to 75% of the brightness when operating exclusively on battery power. This prolongs the battery life between charges. It can be turned off by tapping on the checkbox.

The Main Menu

The *Main Menu* screen is the center for all the available functions for the Magellan RoadMate. The *Main Menu* consists of two pages with large, easy to access icons.

Accessing the Main Menu

From the *Map* screen tap the **Menu** button. 

From the other screens, tap the **Back** button. 

.Main Menu - Page 1

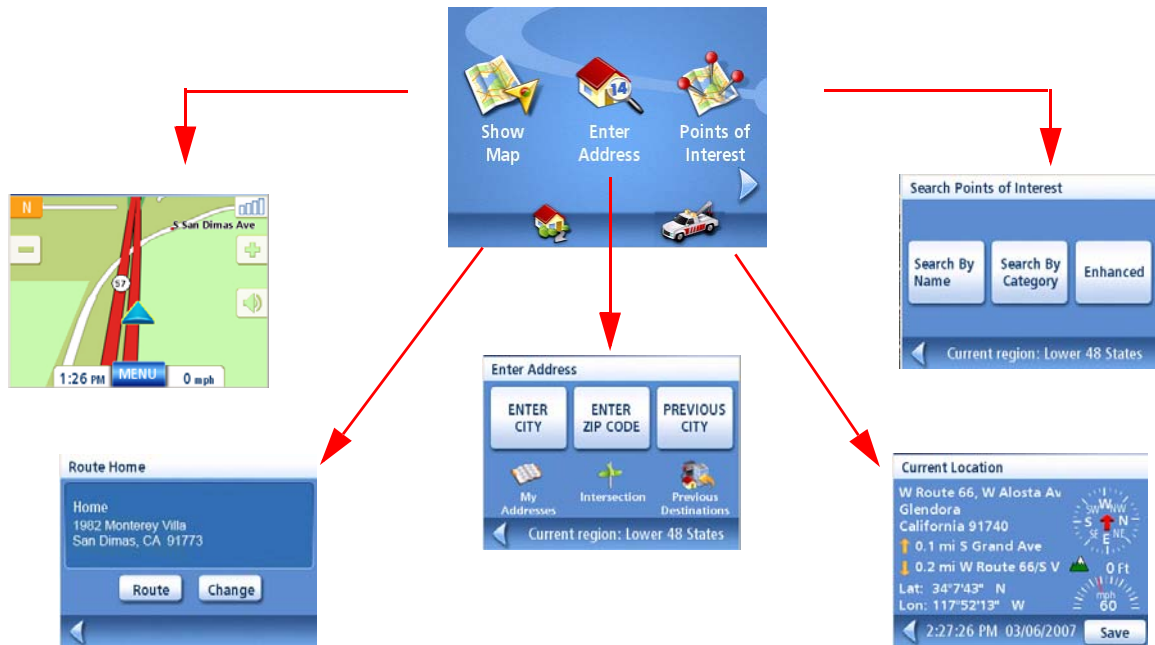

Show Map: Displays the map with your current position (if computing a position from the GPS signals) indicated by the blue triangle. See the Map Screen chapter for details.

Enter Address: Displays *Enter Address* menu. Addresses can be entered by first entering the city, zip code, or by selecting a city from a list of cities you have already used as destinations. Also provides access to your address book (my addresses) or to create a route to an intersection. See the chapter on Routing to an Address for details.

Points of Interest: Displays the *Search Points of Interest* menu. Search for POIs by entering the name or by selecting from a list of available categories.

Home: If you have created a Home address, press the Home button for quick access for routing to your home. If a Home address has not been created, a prompt is displayed to do so. See the Home Button chapter for more information.

Roadside Assistance: Displays the *Locate* screen for easy access to information about your present position should you require assistance.

.Main Menu - Page 2

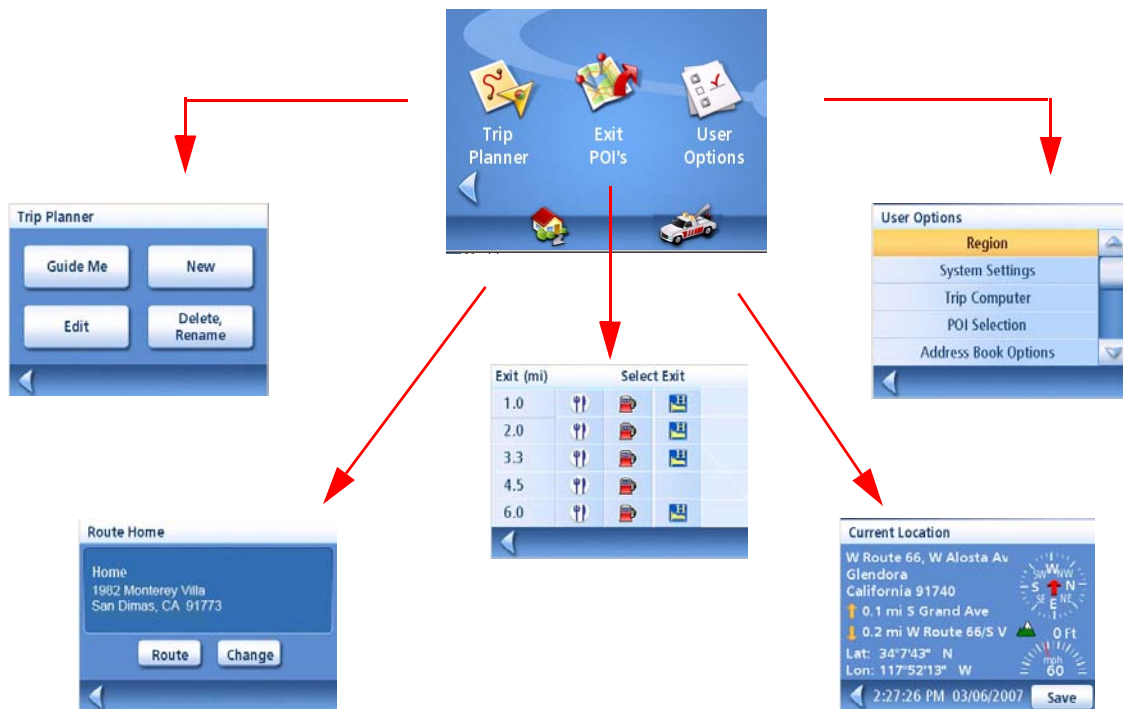

Trip Planner: Opens the Trip Planner menu where you can create, edit, delete, rename or activate a trip.

Exit POI's: (Accessible only while on a freeway.) Provides a listing of restaurants, gas stations, or hotels near approaching freeway exits. You can select one of the POIs presented and create a route to it.

User Options: Accesses the User Options menu. This menu can be used to access functions used to customize the Magellan RoadMate to your personal needs.

Home: If you have created a Home address, press the Home button for quick access for routing to your home. If a Home address has not been created, a prompt is displayed to do so. See the Home Button chapter for more information.

Roadside Assistance: Displays the *Locate* screen for easy access to information about your present position should you require assistance.





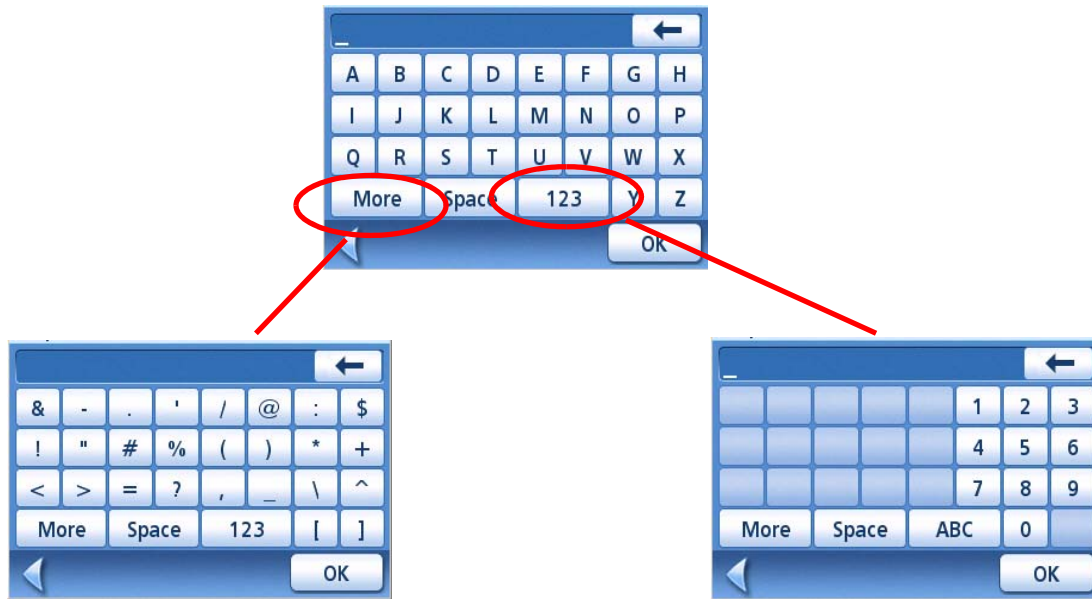

The Keypad

Understanding the keypad while entering an address is an important part of using your Magellan RoadMate. The keypad is the most common means of entering data into the Magellan RoadMate.

Keypad Overview



Special Keys

	Alphabetic Keypad		Numeric Keypad
	Symbols Keypad		Spacebar
	Backspace		
	Accept		Cancel

Selecting From List

After tapping "OK" to accept your input you may get a list of items found in the database. The sample here shows the result of tapping "OK" after entering "LOS A". Use the scroll bar to move up and down the list and tap on the desired item in the list to continue.

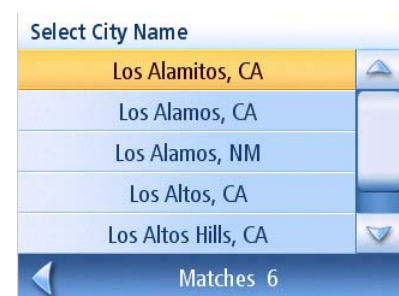

Notes on Entering Data

If you are having trouble getting the results you expected here are a few useful tips.

- Make sure that you have spelled the name correctly. If you are unsure of the spelling, just enter a few characters and tap “OK”. A long list of names will be displayed but you can step through the list and probably be able to find the correct spelling.
- Check for apostrophes and hyphens. If you are not seeing the POI you are looking for in the POI list, check to see if the name has an apostrophe or hyphen.
- When entering a street name you can use the street prefix (N. E. W. S. etc.) to narrow the search. For example to find N. Main St. you could enter “N. Main” or “N Main”.
- The more characters you enter, the smaller the list of possible options from which to choose.

Map Screen

The most commonly used screen will be the *Map* screen. Whether on a route or just travelling around town, chances are the *Map* screen will be displayed. There are two unique modes that the *Map* screen can be displayed in; normal and routing.

In normal mode, your position is shown on the map along with the time and your speed. As you travel, your position will be updated, giving you a clear view of your position and surrounding streets.

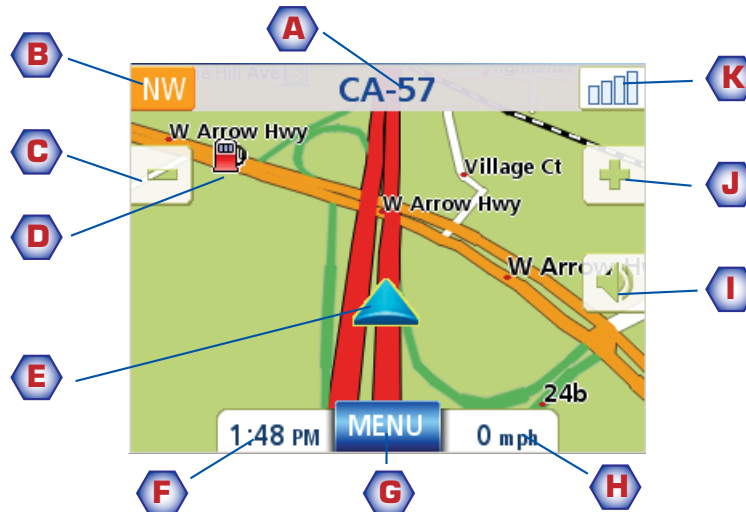

Map Screen - Normal Mode

- A** Street name currently on.
- B** Direction indicator. Tap to view the Current Location screen where you can save your position into your Address Book.
- C** Zoom out
- D** POI icon. Sample shown here is for a gas station. Tap on the POI icon to create a route to that POI. Note: If there are multiple POIs in the same area, a list of those POIs will be displayed. Tap on the name in the list to access the routing function.
- E** Current position icon
- F** Time of day
- G** Main Menu button. Tap to display the *Main Menu*.
- H** Current speed of travel
- I** Volume control. Tap to display the *Volume Setting* screen where the loudness can be adjusted or muted. (If the volume has been muted, tapping this button unmutes the volume without displaying the Volume Setting screen.)
- J** Zoom in
- K** Satellite Status. All four bars in green is optimal. Tap to display the *GPS Status* screen.

In routing mode additional information is displayed providing detailed information about the route you've selected.



Map Screen - Routing Mode

- A** Street name currently on.
- B** Direction indicator. Tap to view the Current Location screen where you can save your position into your Address Book.
- C** Zoom out
- D** POI icon. Sample shown here is for a gas station. Tap on the POI icon to create a route to that POI. Note: If there are multiple POIs in the same area, a list of those POIs will be displayed. Tap on the name in the list to access the routing function.
- E** Current position icon
- F** Next maneuver icon. Tap on the icon to display the *Maneuver List* screen.
- G** Distance to next maneuver. Tap to repeat the last voice command.
- H** Main Menu button. Tap to go to the Main Menu screen. Note that the Main Menu screen is different when there is an active route. See the chapter on Routing for details.
- I** Tap to toggle between distance remaining to reach destination, approximate time remaining until the destination is reached and the approximate the time of day to arrive at the destination.
- J** Street name for the next maneuver
- K** Graphical representation of the route
- L** Volume control. Tap to display the *Volume Setting* screen where the loudness can be adjusted or muted. (If the volume has been muted, tapping this button unmutes the volume without displaying the Volume Setting screen.)
- M** Zoom in
- N** Satellite Status. All four bars in green is optimal. Tap to display the *GPS Status* screen.

Accessing the Map Screen

1. On the Main Menu, tap **Show Map**.



2D Mode

The map is normally displayed in 3D mode but you can set the map to 2D mode if so desired. Choose the mode that is best suited for you.

In 2D mode, you can pan across the map looking for a location to route to or save in your address book.

Setting the Map Modes (2D or 3D)

1. From the *Map* screen, tap **MENU**.
2. Tap the **Next arrow** to access page 2 of the *Main Menu*.
3. Tap **User Options**.
4. Tap **Map Options**.
5. Tap **3D Map** or **2D Map**.
6. Tap **Save**.



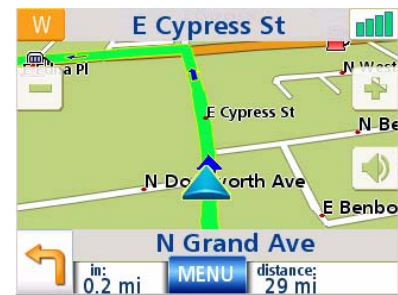

Map Screen in 2D Mode









Map Screen in 3D Mode

Panning on the Map



1. While viewing the *Map* screen in 2D mode, slide your finger or stylus across the map.
2. The location icon changes to . (The circle is the crosshairs for a position and the red arrow points to your current location.)
3. To exit panning, tap  and the map is returned to your current position.

Saving a Position While Panning

1. Pan the map until the icon crosshairs are over the location you want to save to your address book. (Must be a position that does not have a POI icon displayed.)
2. Tap in the center of the icon circle. (If nothing happens then you are not zoomed in enough. Tap the zoom in icon and try again.)
3. On the *Route To This Address?* screen, tap .
4. Edit Information:
Tap  on the Edit Name line to create a name for this location.
Tap on any of the three (work, home, mobile) phone buttons to enter a phone number.
Tap  on the Edit Information line to add additional information. (Up to 35 characters can be entered.)
5. If you want to tag this location as one of your favorites, tap on the “Favorite” check box.

- When the details for this address are acceptable, tap  .
- If you want to now route to this address tap  or if you are done tap  .
- Tap  to exit panning and return the icon to your current position.

Routing to a Panned Position

- Pan the map until the icon crosshairs are over the location you want to route to.
- Tap in the center of the icon circle. (If nothing happens then you are not zoomed in enough. Tap the zoom in icon and try again.)
- On the *Route To This Address?* screen, tap  ,
- Select the routing method desired and tap the Calculate Route  button.

Current Location Screen

This screen is accessed from the *Map* screen whether you are on a route or just normal driving.





The *Current Location* screen displays approximate address information, the next and previous cross streets, as well as your latitude/longitude. To the right is a compass point in your direction of travel, calculated elevation, and speed. The bottom bar displays the current time and date.



Accessing the Current Location Screen

- From the *Map* screen, tap the direction icon in the upper left corner.

Saving Your Current Location to Your Address Book

- Access the *Current Location* screen.
- Tap  .
- Edit Information:
 Tap  on the Edit Name line to create a name for this location.
 Tap on any of the three (work, home, mobile) phone buttons to enter a phone number.
 Tap  on the Edit Information line to add additional information. (Up to 35 characters can be entered.)
- If you want to tag this location as one of your favorites, tap on the "Favorite" check box.
- When the details for this address are acceptable, tap  .

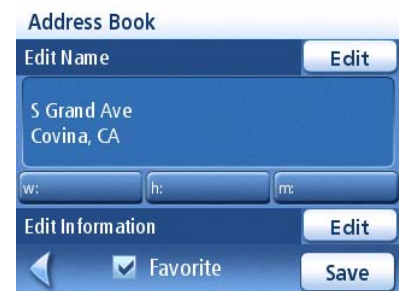

Saving Current Location

Maneuver List Screen

This screen is accessed from the Map screen and only when routing. (Note: The Maneuver List screen is not available until you begin moving on the route.)

Each line in the maneuver list provides details about the maneuver in the order that they are to be made, with the next maneuver at the top.

The bottom bar of the Maneuver List indicates the distance and time to the next maneuver as well as the total distance computed for the route.

The Maneuver List can be modified if you want to exclude one of the maneuvers should you want to avoid travelling one of the streets listed. Instructions to exclude one of the maneuvers is described in this chapter.

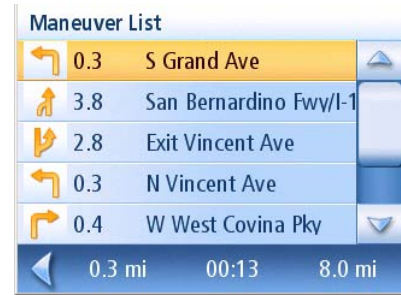

Maneuver List

The maneuver highlighted indicates that you will be instructed to make a left turn in 0.3 miles on S. Grand Ave.

Accessing the Maneuver List

1. Tap the maneuver icon in the lower left corner of the Map screen. This icon is displayed only while on an active route.

Excluding a Maneuver

This is used to modify the route to possibly avoid routing on a particular street.

1. Access the Maneuver List.
2. Tap on the item in the list with the street you want to try and avoid.
3. Confirm the exclusion by tapping on . (Tap the back arrow to cancel.)
4. The Magellan RoadMate recalculates the route and displays the Maneuver List with the newly computed maneuvers.

GPS Status Screen

1. The *GPS Status* screen is also accessed from the *Map* screen and displays the status of the GPS satellites in a graphical format. (More technical information on the GPS status can be found in under the User Options menu: Main Menu Page 2 > User Options > GPS Options > GPS Status.)

Green bars indicate that the Magellan RoadMate is using these satellites to compute the position; orange bars indicate that the Magellan RoadMate is trying to lock on to

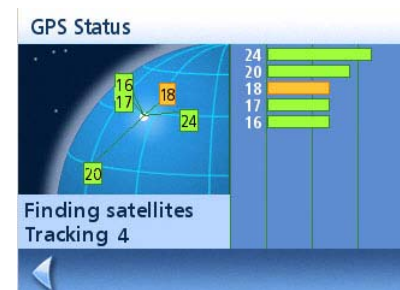

GPS Status Screen

the satellite signal; and no bar shown indicates a satellite that is not being tracked. The longer the bars, the better the signal.



Accessing the GPS Status Screen

1. From the *Map* screen, tap the GPS Signal Strength icon in the upper right corner.
Tap on the back arrow to return to the *Map* screen.

Zoom Levels

There are 23 zoom levels in the Magellan RoadMate, ranging from 100 feet to 1200 miles. Select the zoom level that best suits your needs.



Setting Zoom Levels

1. While viewing the *Map* screen, tap on the  (zoom in) or  (zoom out).

Volume

The volume can be adjusted or muted from the *Map* screen. (The volume can also be adjusted from User Options > System Settings > Volume.)

Changing the Volume from the Map Screen.

1. Tap the speaker icon .
2. Tap on the Mute button to mute the volume or tap inside the volume adjust bar below the Mute button to change the volume levels.
3. Tap .

If you have the volume muted the speaker icon is displayed with a line through it indicating it is muted. To unmute, tap the speaker icon again.

Home Address

Your home address can be entered and saved in the Magellan RoadMate for quick and easy access when you need to create a route home.

Creating a Home Address

These instructions only apply if you have never entered a home address or if it has been deleted.

1. Tap the Home Address icon  on the *Main Menu* screen.
2. Confirm “Do you want to enter your HOME address?” Tap **Yes**.
3. Follow the prompts to enter the address to be used as your HOME address.
4. When the Address screen is displayed, edit the information and top **SAVE** to continue.
5. The HOME address is saved in your address book and you are returned to the *Main Menu* screen.

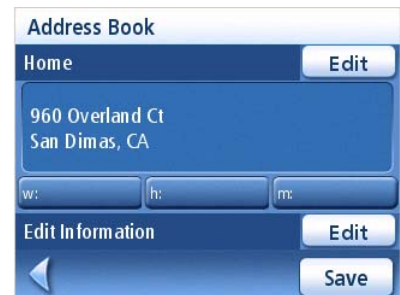

Creating a Route to the Home Address

1. Tap the Home Address icon  on the *Main Menu* screen.
2. Tap **Route**.
3. Select the Route Method desired and tap the orange **Calculate Route** button.



Changing the Home Address

1. Tap the Home Address icon  on the *Main Menu* screen.
2. Tap **Change**.
3. Confirm “Do you want to replace the HOME address with a new address?” Tap **Yes**.
4. Follow the prompts to enter the address to be used as your new HOME address.

- When the Address screen is displayed, edit the information and tap **SAVE** to continue.
- The new HOME address is saved in your address book and you are returned to the *Main Menu* screen.

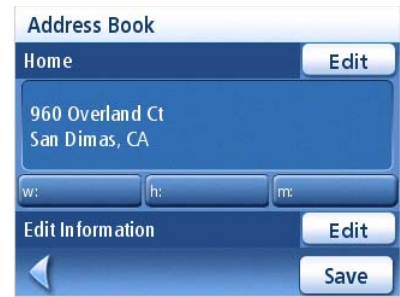

Accessing the Home Address from the Address Book

- From the *Main Menu*, tap the **Enter Address** icon.
- Tap the **My Addresses** icon.
- Tap **Address Book**.
- Tap **List All**.
- The list of addresses in your address book are displayed with the home icon on the line of your HOME address.
- Tap on the home item in the list to create a route to, edit or delete the HOME address.

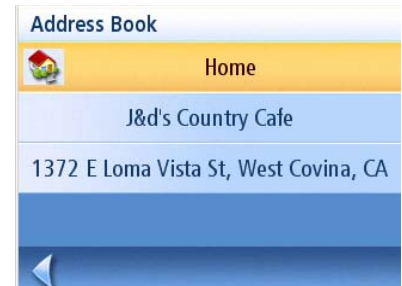

Current Location

The Current Location screen provides necessary information about your present location, intersections ahead and behind your, as well as a convenient way of adding your current location to your address book.

Accessing the Current Location Screen

The Current Location screen can be accessed from the Main Menu or from the Map Screen.

From the Main Menu

1. Tap  .

From the Map Screen

1. Tap the direction indicator.







The Current Location Screen

The *Current Location* screen displays approximate address information, the next and previous cross streets, as well as your latitude/longitude. To the right is a compass point in your direction of travel, calculated elevation, and speed. The bottom bar displays the current time and date.



Saving Your Current Location to Your Address Book

1. Access the *Current Location* screen.
2. Tap .
3. Edit Information:
Tap  on the Edit Name line to create a name for this location.
Tap on any of the three (work, home, mobile) phone buttons to enter a phone number.
Tap  on the Edit Information line to add additional information. (Up to 35 characters can be entered.)
4. If you want to tag this location as one of your favorites, tap on the “Favorite” check box.
5. When the details for this address are acceptable, tap  .

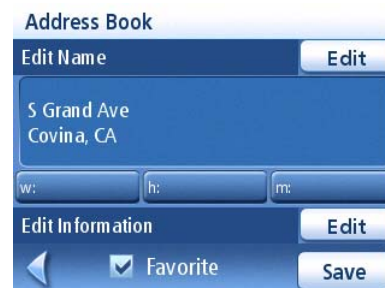

Saving Current Location

Enter Address

The Enter Address function is used to create a route from a newly entered address, an address in your address book or to an intersection of two streets.

Entering an Address

While creating an address the first step is to indicate what city the address is in. This can be done by inputting the name of the city, entering the zip code for the city or by selecting a city that has been previously used.

Creating a Route to a New Address

1. From the *Main Menu*, tap the **Enter Address** icon.



2. Select the method to enter the city: **Enter City**, **Enter Zip Code**, or **Previous City**.

Enter City:

Use the keypad to enter the first few characters of the city name. Tap **OK** to display the list of cities found.

Tap on the desired city in the list.

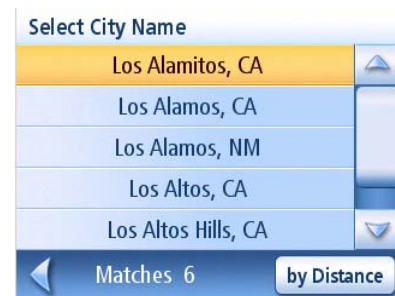

List of Cities

Enter Zip Code:

Use the keypad the zip code for the city. Tap **OK** when the zip code is complete.

The button in the lower right corner is used to select the sorting order of the list, by zip code or alphabetically.

Tap on the desired city in the list.



Cities with the Zip Code Entered

Previous City:

Tap on the desired city in the list.

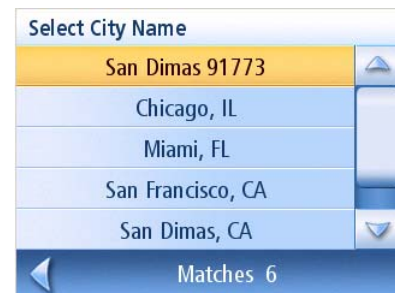

List of Cities Previously Used

- With the city selected, the keypad will be displayed asking for the street name. Use the keypad with QuickSpell to enter the street name. Enter the first few characters of the street name and tap OK or continue entering characters until the list of streets is displayed. You can use street prefixes (N, E, W, S, etc.) if desired.

Samples the city Pasadena, California:

Entering "ALLE" results in:

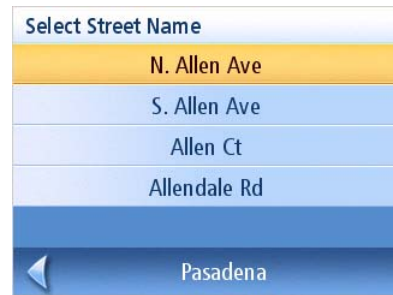

Entering "N A" or "N. A" results in:

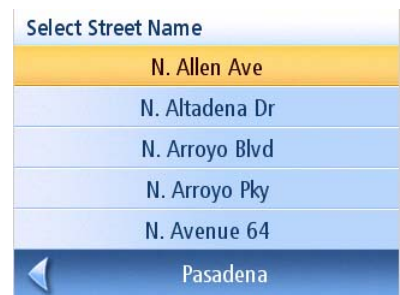

However, typing in "NOR" can give some unexpected results if you are trying to type in the word "NORTH ALLEN".:

Entering "NOR"



To resolve this, use the back arrow from the street list and continue typing in the word NORTH. Now all streets beginning with "North" as well as streets with the north prefix are displayed.

Entering "NORTH"

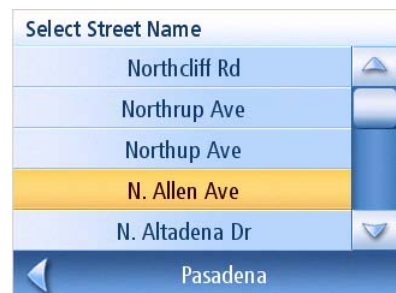

- Use the scroll bars to the right if necessary to view the name of the street desired. Tap on the street name to continue.
- Use the keypad to enter the street number for the address. Note in the top left corner is the range of acceptable street numbers.
- Tap **Done** when the address is complete.
- Select the desired route method and tap the orange **Calculate Route** button to begin routing.

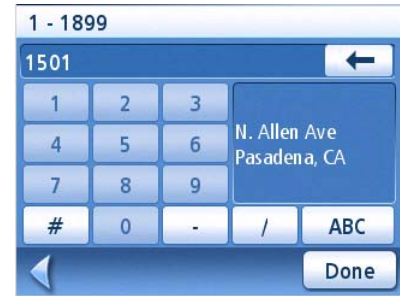

My Addresses

My Addresses is where you store addresses that you want to keep as future destinations as well as access addresses that you have gone to recently that may not be in your address book. The address book can hold up to 100 addresses.

Accessing the My Addresses Menu

- From the *Main Menu*, tap the **Enter Address** icon.



- Tap on the **my addresses** icon.
- The *My Addresses Menu* is displayed.





Previous Destinations

Routing to a Previous Destination (Method 1)



- From the *Main Menu*, tap the **Enter Address** icon.
- Tap on the **Previous Destinations** icon.
- Select the destination from the list of previous destinations.
- Select the Route Method and tap the orange **Calculate Route** button.





Routing to a Previous Destination (Method 2)

1. From the *Main Menu*, tap the **Enter Address** icon. 
2. Tap on the **my addresses** icon. 
3. Tap on **Previous Destinations**.
4. Select the destination from the list of previous destinations.
5. Tap on **Route**.
6. Select the Route Method and tap the orange **Calculate Route** button.

Saving a Previous Destination to Your Address Book

1. From the *Main Menu*, tap the **Enter Address** icon. 
2. Tap on the **my addresses** icon. 
3. Tap on **Previous Destinations**.
4. Select the destination from the list of previous destinations.
5. Tap on **Edit**.
6. Apply any edits you want to make to this destination before saving.
7. Check Favorite if you want this addresses store in your address book as a Favorite.
8. Tap **Save** to store the address.
9. The *Previous Destination* screen is displayed. Tap **Route** to route to this destination or the **Back** arrow to return to the list of previous destinations.



Deleting a Previous Destination

1. From the *Main Menu*, tap the **Enter Address** icon. 
2. Tap on the **my addresses** icon. 
3. Tap on **Previous Destinations**.
4. Select the destination from the list of previous destinations.
5. Tap on **Delete**.
6. Confirm Deletion. Tap **Yes**.
7. The *Enter Address Menu* will be displayed.

It is possible to delete all of the destinations in the Previous Destination List by accessing User Options > Address Book Options > Clear Previous.

Address Book

Accessing an Address in Your Address Book

1. From the *Main Menu*, tap the **Enter Address** icon. 
2. Tap on the **my addresses** icon. 
3. Tap on **Address Book**
4. Tap List All to view the entire contents of your address book or tap on Search Address Book to search for entries by searching on the name.
5. From the list of addresses found, tap on the address record desired.

Routing to an Address in Your Address Book

1. Access the address record from your address book as described in *Accessing an Address in Your Address Book*.
2. Tap on **Route**.
3. Select the Route Method and tap on the orange **Calculate Route** button to continue.

Editing an Address in Your Address Book.

1. Access the address record from your address book as described in *Accessing an Address in Your Address Book*.
2. Tap on **Edit**.
3. Use the *Edit Address Book* screen to modify the name, information or phone numbers. The street address cannot be changed.
4. Tap **Save** when done.



Deleting an Address in Your Address Book.

1. Access the address record from your address book as described in *Accessing an Address in Your Address Book*.
2. Tap on **Delete**.
3. Confirm deletion. Tap **Yes**.
4. You are returned to the list of addresses in your address book. If the list is now empty, you are returned to the previous screen.

Favorites

Favorite addresses operate the same as other addresses in your address book. Addresses in your address book can be marked as favorites to speed up the search for commonly used addresses.

Accessing an Address from Favorites

1. From the *Main Menu*, tap the **Enter Address** icon. 
2. Tap on the **my addresses** icon. 
3. Tap on **Favorites**
4. From the list of addresses found, tap on the address record desired.

Routing to an Address from Your Favorites List

1. Access the address record from your Favorites as described in *Accessing an Address from Favorites*.
2. Tap on **Route**.
3. Select the Route Method and tap on the orange **Calculate Route** button to continue.

Editing an Address from Your Favorites List

1. Access the address record from your Favorites as described in *Accessing an Address from Favorites*.
2. Tap on **Edit**.
3. Use the *Edit Address Book* screen to modify the name, information or phone numbers. The street address cannot be changed.
4. Tap **Save** when done.



Deleting an Address from Your Favorites List

1. Access the address record from your Favorites as described in *Accessing an Address from Favorites*.
2. Tap on **Delete**.
3. Confirm deletion. Tap **Yes**.



Creating a New Entry

This is used to create a new address and save it in your address book. You can create an entry by selecting it on the map, entering the address, selecting an address from the list of POIs or choosing a street intersection.



Creating a New Entry to Your Address Book by Selecting on the Map

1. From the *Main Menu*, tap the **Enter Address** icon. 
2. Tap on the **my addresses** icon. 
3. Tap on **Create New Entry**.
4. Tap on **Select on Map**.
5. The Map screen is displayed in 2D mode. Use your finger or stylus to pan around the map. When the crosshair icon is over the location you want to add to your address book, tap in the center of the crosshairs. (Note: you may need to zoom into a lower zoom level if the edit Address Book screen is not displayed.)
6. Edit the name, information and phone numbers for the location you selected on the map. Tap the Favorites checkbox if you want this saved as a favorite address.
7. Tap **Save**.

Creating a New Entry to Your Address Book by Entering an Address

1. From the *Main Menu*, tap the **Enter Address** icon. 
2. Tap on the **my addresses** icon. 
3. Tap on **Create New Entry**.
4. Tap on **Enter Address**.
5. Enter the address following the prompts. Detail on address entry can be found in this chapter in the Entering an Address section,
6. Edit the name, information and phone numbers for the location you selected on the map. Tap the Favorites checkbox if you want this saved as a favorite address.
7. Tap **Save**.

Creating a New Entry to Your Address Book from a POI

1. From the *Main Menu*, tap the **Enter Address** icon. 
2. Tap on the **my addresses** icon. 
3. Tap on **Create New Entry**.
4. Tap on **POIs**.
5. Select the category from the list of POI categories.
6. If a subcategory list is displayed, select ALL Subcategories or one from the list.



7. Select search criteria:

Near Current Position Displays POIs in the category selected nearest to your current position. If no POIs are within a 50 mile radius, the search is empty and an alert displayed.

Near City: Enter a city name using the keypad (no QuickSpell) and select the city center desired from the resulting list. This will display POIs in the category selected nearest to the city center selected.(



Near Address: Enter an address using the standard address entry function. This will display POIs in the category selected nearest to the address entered.
8. Tap on the POI name desired from the list. Use the **Prev** and **Next** buttons to scroll up and down the list.(
9. Edit the name, information and phone numbers for the POI selected. Tap the Favorites checkbox if you want this saved as a favorite address.
10. Tap **Save**.

Creating a New Entry to You Address Book from by Intersections

1. From the *Main Menu*, tap the **Enter Address** icon. 
2. Tap on the **my addresses** icon. 
3. Tap on **Create New Entry**.
4. Tap on **Intersection**.
5. Select the city that the intersection is located in by entering the city name, entering the zip code or selecting from the previous cities list.
6. Search for the first street by spelling out the street name following the guidelines presented in *Entering an Address*. Tap on the street from the list of streets.
7. Search for the second street the same as in step 6. However, the Magellan RoadMate uses QuickSpell to allow you to select only streets that intersect with the street selected in step 6. Tap on the intersecting street from the list of streets.
8. Edit the name, information and phone numbers for the POI selected. Tap the Favorites checkbox if you want this saved as a favorite address.
9. Tap **Save**.

Intersection

Creating a Route to Two Intersecting Streets

1. From the *Main Menu*, tap the **Enter Address** icon. 
2. Tap on the **intersection** icon. 

3. Select the city that the intersection is located in by entering the city name, entering the zip code or selecting from the previous cities list.
4. Search for the first street by spelling out the street name following the guidelines presented in *Entering an Address*. Tap on the street from the list of streets.
5. Search for the second street the same as in step 6. However, the Magellan RoadMate uses QuickSpell to allow you to select only streets that intersect with the street selected in step 6. Tap on the intersecting street from the list of streets.
6. Select the Route Method and tap on the orange **Calculate Route** button.

Points of Interest (POI)

The Magellan RoadMate has POIs preloaded that can be used as a destination for a route. Selecting a restaurant or finding an ATM nearby is at your fingertips.

Categories and Subcategories

POIs are categorized into unique categories from gas stations to wineries. Most, but not all categories are further organized into subcategories. Restaurants have, for example, 16 subcategories that provide a way to search for restaurants serving Chinese food, or fast food, and even Swiss food.

Creating a Route to a POI by Category

1. From the *Main Menu*, tap the **Points of Interest** icon.
2. Select **Search by Category**.
3. Use the scroll bars to view the categories and tap on the desired category name.

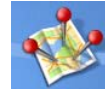

Category List

4. If a subcategory is displayed, use the the scroll bars to view the subcategories and tap on the desired subcategory name. Select ALL SUBCATEGORIES if you are unsure what subcategory best suits your needs.
5. Select the search criteria: **Near Current Position**, **Near What City?** (requires entering a city name) or **Near Address** (requires entering an address).
6. The top portion of the display shows detailed information about the highlighted POI in the list. The arrow and distance indicates the direction and distance in a straight line from your current position to the POI. Use the Prev and Next buttons to step up and down the list of POIs found. Tap on the POI name to continue.
7. Select the route method and tap on the orange **Calculate Route** button to begin.



Sample Restaurant Sub Category List



Restaurants Near Current Position

Creating a Route to a POI by Name

1. From the *Main Menu*, tap the **Points of Interest** icon.
2. Select **Search by Name**.
3. Spell the name of the POI to be used as the destination. You need not enter the full name, but the more characters you enter, the easier it will be to find the exact POI you are searching for.
4. Select the search criteria: **Near Current Position, Near What City?** (requires entering a city name) or **Near Address** (requires entering an address).

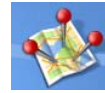

Sample Search by Name Input

5. The top portion of the display shows detailed information about the highlighted POI in the list. The arrow and distance indicates the direction and distance in a straight line from your current position to the POI.
Not that searching by name will show all POIs that meet the name criteria, regardless of category. In the sample shown here, there are home improvement centers (Lowe's) and parks (Lowell Brandt Park).



Search Result for LOWE Near Position

- Use the Prev and Next buttons to step up and down the list of POIs found. Tap on the POI name to continue.
6. Select the route method and tap on the orange **Calculate Route** button to begin.

Travelling on a Route

Map Screen

When a route has been calculated it will be displayed on the *Map* screen in green with blue arrows indicating direction of travel. The top of the screen displays the name of the street you are on. The bottom provides information about the next maneuver needed.

The sample to the right shows that the next maneuver will be to turn right in 3.3 miles on Fairplex Dr. The total distance to the destination is 4.7 miles.

As the route progresses, voice alerts will be used to prompt you of upcoming maneuvers. If you miss a prompt, or want it repeated, tap on the ‘next maneuver in xxx mi.’ data field.

There is also a bell that will alert you where the maneuver is to be performed. (This tone can be changed in User Options > Tone Options.)

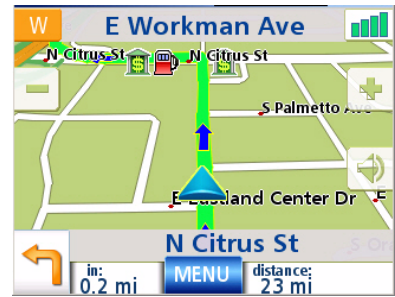

Map Screen with Route Shown

Split-Screen

As a maneuver is approached, the Magellan RoadMate displays a split-screen alerting you of the upcoming maneuver. This screen will close automatically as the maneuver gets closer or you can tap **ESC** to close this screen and return to the *Map* screen. (This screen can be set to not display in User Options > Map Options.)

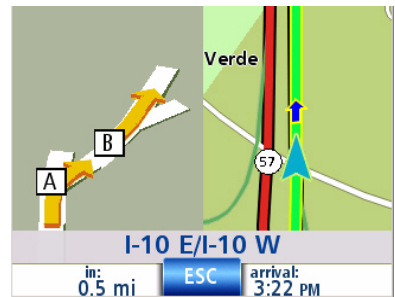

Split-Screen

Maneuver List

The Maneuver List displays all of the maneuvers needed to be made to complete the route and arrive at the destination. To view the Maneuver List, tap on the maneuver icon in the bottom left corner of the *Map* screen. (The Maneuver List is described in detail in the Map chapter of this manual.)



Maneuver List

You Have Arrived

Finally, the Magellan RoadMate will provide a visual alert when you have arrived at the destination. Tap the **Back** arrow to return to the *Map* screen. (The Magellan RoadMate will automatically return to the *Map* screen after a fixed time if you do not tap the **Back** arrow.)

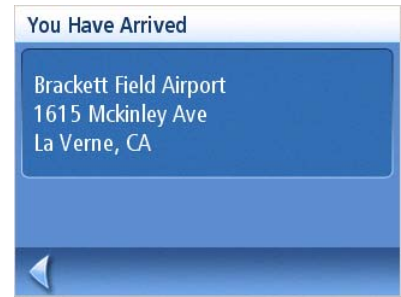

You Have Arrived.

Types of Routes

There are a wide variety of ways to create a route and each of them are discussed in the chapter that they are associated with. Some of the more common methods and the chapter they are described are:

- A route to a new address (*Street Address*)
- A route to an address in your address book (Street Address)
- A route to a Previous Destination (Street Address)
- A route to a street intersection (Street Address)
- A route to a POI preloaded in the Magellan RoadMate (Points of Interest)
- A trip (a route with multiple destinations) (Trip Planner)
- A route to your home address (Home Address)

Route Method

Regardless of which route type has been created, the Magellan RoadMate needs to know how the route is to be calculated. Routes can be calculated by Fastest Time, Shortest Distance, Least Use of Freeways or Most Use of Freeways. To select the route method, tap on the radio button for the desired method.

The Magellan RoadMate can be set to avoid toll roads as much as possible by tapping on the Avoid Toll Roads checkbox.

The View on Map  button displays the Map screen with the destination shown. Tap on **ESC** to return to the Route Method screen.

When the route method has been selected and you are ready to begin calculating the route, tap on the Route Calculate button.



Route Method



Route Calculate button









Special Routing Functions

When a route is active, the Main Menu functions are changed to support special routing functions.

Routing to a POI Near an Approaching Freeway Exit

Note: This function is available only while on a freeway. Also, when you create a route to a POI near an exit, the original route will be cancelled. You will need to reset the original route when you are ready to continue.

1. From the *Map* screen, tap **MENU**.
2. Tap the **Exit POIs** icon. 
3. Tap on the POI icon (restaurant, gas station or hotel) for the exit required.
4. A list of POIs in the category selected that are near the exit chosen will be displayed.
5. Tap on the POI in the list that you want routing directions to.
6. Select the Route Method and tap the orange **Calculating Route** button.

Exit (mi)	Select Exit		
1.2			
2.3			
2.9			

Exit POI List

Cancelling a Route

1. From the *Map* screen, tap **MENU**.
2. Tap the **Cancel Route** icon. 
3. Confirm cancelling of the route. Tap **Yes**.

Detouring off a Route

1. From the *Map* screen, tap **MENU**.
2. Tap the **Detour** icon. 
3. Select the distance to avoid (3 mi., 5 mi., 10 mi. or Custom) that will be used to calculate the route will then put you back on the original route.
4. Tap **Route**.
5. The detour will be calculated using the same routing method used to create the route.

Changing the Route Method

If you travel off the computed route, the Magellan RoadMate will automatically re-calculate the routing information to get you to your original destination using the routing method you selected when creating the route. However, if you want to change the routing method (while on or off the route), you will need to use the re-route function.

1. From the *Map* screen, tap **MENU**.

2. Tap the **Reroute** icon.



3. Select the desired routing method and tap the orange **Calculate Route** button.

Trip Planner

The Trip Planner is used to create a route with multiple destinations. In this document we refer to a route with multiple destinations as a “Trip”.

Creating a Trip

1. From page 2 of the Main Menu, tap the **Trip Planner** icon.
2. Select **New** from the Trip Planner Menu.
3. Use the keypad to enter in a name for this trip.
4. Tap **OK**.



Enter a Trip Name

5. Begin by adding the first destination in the trip. Tap **Add**.
6. Select the method to be used to find or create the destination icon: **Enter Address, Address Book, POIs, or Intersection**.
7. Follow the instructions for the method chosen to select the destination.

See the chapters on *Enter Address* and *POI* for help in selecting destinations.

8. When the destination is found the *Add Address to Trip* screen is displayed. Tap **Save**.

Tap add to begin

Tap Save to Add the Address

9. The list of trip destinations is displayed.



First Destination Added

10. Tap on the destination name to bring up the menu.

Shortcut: if you just want to append a destination to the list, use the **Append** button at the bottom of the display.

11. Repeat steps 5 through 9 until the trip is complete with all desired destinations.

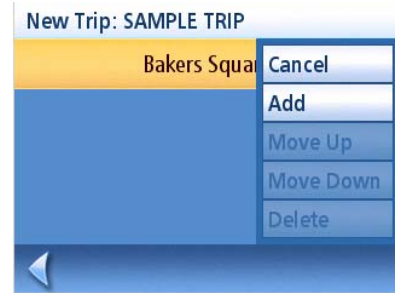

Tap on Heroes Bar & Grill to open menu.

12. Tap **Save**.

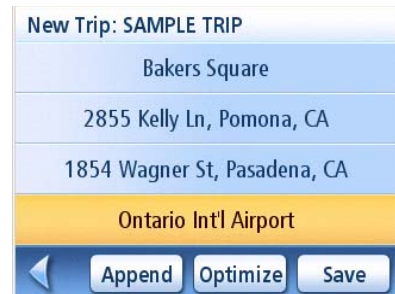

Saving completed trip.

Optimizing a Trip

While creating a trip or editing a trip you can optimize the order of the destinations but using the Optimize button.

1. View the trip list, either while creating the trip or from the **Edit** button when selecting **Trip Planner**.
2. Tap **Optimize**.
3. Tap **Save** to store the changes to the trip.

Starting a Trip

1. From page 2 of the Main Menu, tap the **Trip Planner** icon.
2. Select **Guide Me** from the Trip Planner Menu.
3. Select the trip to be used from the stored trips list.
4. Tap on the destination in the list to be used to as the first destination in the trip.

In the example shown, tapping on 'Heroes Bar & Grill' (first destination in the list) would activate a trip that be from your current position to Heroes Bar & Grill, then Pasadena, CA, then Arcadia, CA and finally Home.

Tapping on the destination in Pasadena, CA would activate a trip that goes from your current position to Arcadia and then Home.

5. Select the routing method to be used and tap the orange **Calculate Route** button.

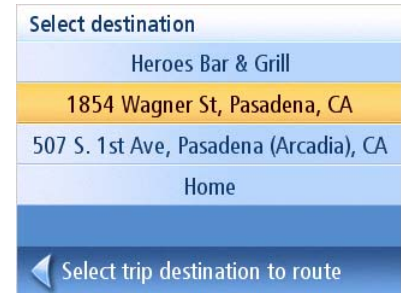

Select first destination.

Editing a Trip

1. From page 2 of the Main Menu, tap the **Trip Planner** icon.
2. Select **Edit** from the Trip Planner Menu.
3. Select the trip to be edited from the stored trips list.
4. Tap on the destination to be edited. You can:

Add a destination following the one selected.

Move the destination up in the list.

Move the destination down in the list.

Delete the destination from the trip.

5. When the trip has been edited, tap **Save**.

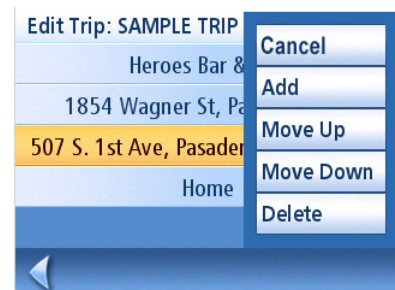

Edit Trip

Deleting a Trip

1. From page 2 of the Main Menu, tap the **Trip Planner** icon.
2. Select **Delete, Rename** from the Trip Planner Menu.



3. Tap **Delete**.
4. Select the trip to be deleted from the stored trips list.
5. Confirm the deletion of the trip. Tap **Yes**.

Renaming a Trip

1. From page 2 of the Main Menu, tap the **Trip Planner** icon.
2. Select **Delete, Rename** from the Trip Planner Menu.
3. Tap **Rename**.
4. Select the trip to be renamed from the stored trips list.
5. Use the keypad to edit the name of the trip.
6. Tap **OK**.



Exit POIs

The Exit POI function provides a way of accessing commonly used POIs that are near an exit you are approaching while travelling on a freeway. Exit POIs include restaurants, gas stations and hotels. Exit POIs can be accessed while on a route or just driving, as long as you are on a freeway.

Routing to a POI Near an Approaching Freeway Exit

Note: This function is available only while on a freeway. Also, when you create a route to a POI near an exit, the original route will be cancelled if you are travelling on a route. You will need to reset the original route when you are ready to continue.

1. From the *Map* screen, tap **MENU**.
2. Tap the **Exit POIs** icon. 
3. Tap on the POI icon (restaurant, gas station or hotel) for the exit required.

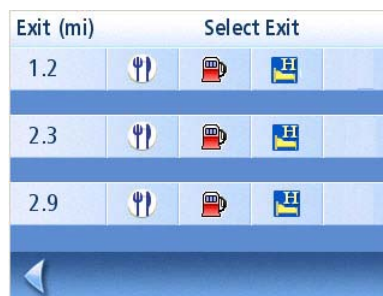

Exit POI List

4. A list of POIs in the category selected that are near the exit chosen will be displayed.
5. Tap on the POI in the list that you want routing directions.
6. Select the Route Method and tap the orange **Calculating Route** button.



Sample List of Automotive POIs

User Options

Use User Options to customize the Magellan RoadMate to better suit your needs from a GPS navigator.

Tapping the **Back** arrow from any of the *User Option* screens will cancel the changes.

Selecting Map Region

Choose the map region you will be travelling in.

1. From page 2 of the Main Menu, tap **User Options**.
2. Tap **Region**.
3. Tap on the desired map region (Lower 48 States, Hawaii, or Puerto Rico).

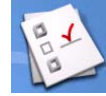

Accessing System Settings

Commonly used settings are found in the System Settings section of User Options.

1. From page 2 of the Main Menu, tap **User Options**.
2. Tap **System Settings**.

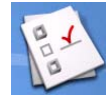

Checking Battery Life

1. From page 2 of the Main Menu, tap **User Options**.
2. Tap **System Settings**.
3. The battery life indicator is found at the bottom of the screen. All green indicated full battery life.



Adjusting the Volume

Volume can also be adjusted by tapping on the speaker icon on the *Map* screen.

1. From page 2 of the Main Menu, tap **User Options**.
2. Tap **System Settings**.
3. Tap **Volume**.
4. Tap along the adjustment bar to increase or decrease the speaker volume.
5. Tap **Mute** to turn the speaker off. Tap **Mute** again to turn the speaker back on.

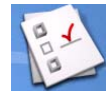

6. Tap **Save**.

Adjusting the Display Brightness

1. From page 2 of the Main Menu, tap **User Options**. 
2. Tap **System Settings**.
3. Tap **Brightness**.
4. Tap along the adjustment bar to increase or decrease the display brightness.
5. Tap **On-battery dimming (75%)** to set it on or off. (Checked is on.) Checking it on will save battery life while operating the Magellan RoadMate without external power.
6. Tap **Save**.

Setting Auto Power Off Time

The auto power setting will define the time that the Magellan RoadMate will automatically turn off if it hasn't moved or the touchscreen accessed.

1. From page 2 of the Main Menu, tap **User Options**. 
2. Tap **System Settings**.
3. Tap **Power**.
4. Select **Never**, **10 Minutes**, **20 Minutes** or **30 Minutes**.
5. Tap **Save**.

Setting Time Zone

1. From page 2 of the Main Menu, tap **User Options**. 
2. Tap **System Settings**.
3. Tap **Time Zone**.
4. Use the “-” and “+” buttons to set through the time zones until the time zone for your area is displayed.
5. Check Daylight Savings if daylight savings is in effect for your time zone. (Daylight savings is not automatically adjusted.)
6. Tap **Save**.

Selecting Units of Measure

1. From page 2 of the Main Menu, tap **User Options**.
2. Tap **System Settings**.
3. Tap **Units of Measure**.
4. Select **Miles/Feet** or **Kilometers/Meters**.
5. Tap **Save**.



Displaying Contact Us Information

1. From page 2 of the Main Menu, tap **User Options**.
2. Tap **System Settings**.
3. Tap .
4. Tap **Contact Us**.
5. Tap **Back** arrow.

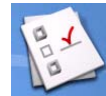

Displaying Product Information

1. From page 2 of the Main Menu, tap **User Options**.
2. Tap **System Settings**.
3. Tap **Next**.
4. Tap **Product Information**.
5. Tap **Next** to view additional product information.
Tap **Prev** to return to page 1.
6. Tap the **Back** arrow to exit.



Performing Diagnostics

1. From page 2 of the Main Menu, tap **User Options**.
2. Tap **System Settings**.
3. Tap **Next**.
4. Tap **Diagnostics**.
5. Tap **Audio Test**, **Touchscreen Test** or **Video Test**.
6. When done, tap the **Back** arrow to exit.

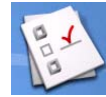

Accessing the Trip Computer

The trip computer records your average speed, the time in hours of the trip, the time in hours that you were driving, and the distance of the trip. This information can be saved to a file for easy access when the information is needed.

1. From page 2 of the Main Menu, tap **User Options**.
2. Tap **Trip Computer**.
3. Select the Current Trip or a Saved Trip from the list.
4. Select **Stop** to stop recording information.

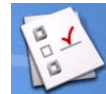

Select **Reset** to set all the information to zero. Select **Reset** when you are starting a trip or route that you want to record details for.

Select **Save** to store the trip computer information to a file. You will be prompted to enter a name for the file. Input a name and tap **OK**.

5. Tap the **Back** arrow to exit.

Current		
Running...		
Average Speed	8	mph
Trip Time	00:00	hrs
Drive Time	00:02	hrs
Trip Distance	0.3	mi

Navigation buttons: Stop, Reset, Save

Current Trip Computer

Selecting POIs to be Displayed on the Map

In some areas the map can be cluttered with POIs making it difficult to find what you are looking for. Use POI Selection to set what categories of icons will be shown and which ones will be hidden.

1. From page 2 of the Main Menu, tap **User Options**.

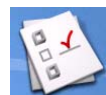

2. Tap **POI Selection**.
3. Tap on the POI category in the list to toggle its display setting on or off. (Checked POIs will be displayed.)

Tap **Mark All** to check all POI categories.

Tap **Clear All** to uncheck all POI categories.

4. Tap **Save** to save changes and exit.



POI Selection Screen

Deleting Addresses from the Address Book (Global)

The chapter on addresses discusses how to delete individual addresses from the address book. Address Book Options provides a way of globally deleting addresses from the address book.

1. From page 2 of the Main Menu, tap **User Options**.

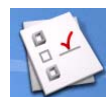

2. Tap **Address Book Options**.
3. Tap **Clear Addresses** to delete all of the addresses in your Address Book.
Tap **Clear Favorites** to delete only those addresses marked as Favorites from your Address Book.
Tap **Clear Previous** to delete previous destinations from the Address Book.
4. Tap the **Back** arrow to exit.

Setting the Map in 3D or 2D Mode

See the chapter on Maps for information regarding 3D and 2D modes of the map.

1. From page 2 of the Main Menu, tap **User Options**.

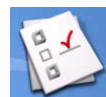

2. Tap **Map Options**.
3. Select **3D Map** or **2D Map**.
4. Tap **Save** to record the changes and exit.

Setting the Map Display to Heading Up or North Up

The map can be displayed with the top of the display in the direction of your heading or North.

1. From page 2 of the Main Menu, tap **User Options**.
2. Tap **Map Options**.
3. Select **Heading Up** or **North Up**. (Note, North Up is available only when the map is set to 2D mode.)
4. Tap **Save** to record the changes and exit.

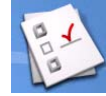

Setting Split Screen (TrueView™) Options

As you approach a maneuver, the display changes to the split screen mode. Under Map Options you can turn off the split screen or set it to be just the TrueView portion of the split screen.

1. From page 2 of the Main Menu, tap **User Options**.
2. Tap **Map Options**.
3. Tap **Auto TrueView** to turn set it to on or off. (Checked is on and the TrueView image will be displayed.)
4. Tap Split TrueView to set the TrueView display to split or single view. (Checked sets split screen on.)

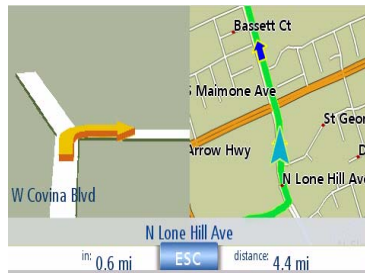

TrueView Split Screen



TrueView Single Screen

5. Tap **Save** to record the changes and exit.

Setting Auto Night Map Display

Normally the map is displayed in the pastel colors for daytime use and a black background for nighttime use. Unchecking the Auto Night Mode will keep the map display using the pastel colors.

1. From page 2 of the Main Menu, tap **User Options**.
2. Tap **Map Options**.
3. Tap on **Auto Night Mode**. (Checked indicates that the map will automatically change to night colors; unchecked and the map will always use the day colors.) Note: If the screen has

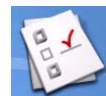

already switched to night colors, unchecking the box will not cause the display to go to the day colors. The switch to day colors will occur the following morning and then stay in day colors.)

4. Tap **Save** to record the changes and exit.

Setting Detour Options

Normally the map is displayed in the pastel colors for daytime use and a black background for nighttime use. Unchecking the Auto Night Mode will keep the map display using the pastel colors.

1. From page 2 of the Main Menu, tap **User Options**.

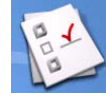

2. Tap **Detour Options**.
3. Select the default for the distance to be used to detour around traffic problems while routing.

Set the alert timer. (Enter the time from the keypad.)

Check Enable automatic detour on or off. (Checked is on and the Magellan RoadMate will automatically offer detour routing when it computes you are stuck in slow or stopped traffic situations.)

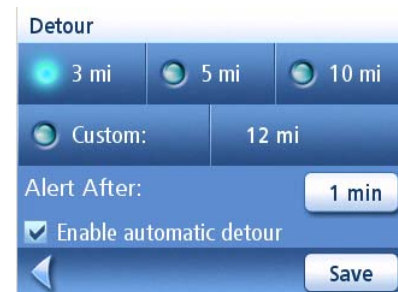

Detour Options Screen

4. Tap **Save** to record the changes and exit.

Using the Simulator

When turned on, the simulator will offer the option of simulating movement on a route. Useful for learning about the Magellan RoadMate while not driving.

1. From page 2 of the Main Menu, tap **User Options**.

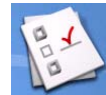

2. Tap **Simulator Mode**.
3. Tap **Propose simulator mode when calculating route**. When checked, the Magellan RoadMate will ask if you want the route simulated when it is created. Simulation mode will ignore actual movement and should only be used for training purposes.

Tap on the speed factor desired.

Tap **<<1mi** or **1m>>** to set the route forward or backwards 1 mile.

Tap **Restart** to begin the route you are currently simulating back to the beginning.

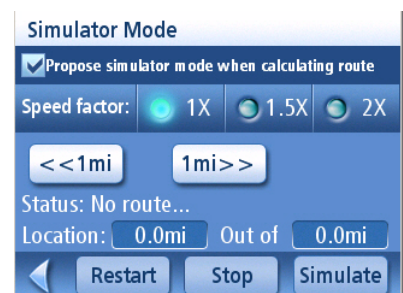

Simulator Mode Screen

Tap **Stop** to end simulating the current route you are simulating.

(The Simulate button is presently not active.)

4. Tap **Back** arrow to record the changes and exit.

Setting Tone Options

Provides a way of selecting the tone used to announce arrival at a maneuver or destination.

1. From page 2 of the Main Menu, tap **User Options**.



2. Tap **Tone Options**.
3. Select **Bell, Chime** or **Beep**.
4. Tap **Save** to record the changes and exit.

Viewing Technical GPS Information

This screen provides technical information about the satellites being used to compute the GPS position.

1. From page 2 of the Main Menu, tap **User Options**.



2. Tap **GPS Options**.

3. Tap **GPS Status**.

PRN: pseudo random number that identifies the satellite

AZ: Azimuth of the satellite

EL: Satellite elevation

SNR: Satellite signal-to-noise ratio

TTF: Time to First Fix (in seconds)

MFG GPS Status			
PRN	AZ	EL	SNR
00	000	00	0
01	009	02	4
02	018	04	8
04	036	08	16
05	045	10	20
06	054	12	24
07	063	14	28

TTF in second: 1; SAT(U/T): 2/3

4. Tap **Back** arrow to exit.

Setting the GPS Position

Setting a GPS position is useful if you are not getting satellite information quickly because the Magellan RoadMate has travelled over 500 miles while turned off. Setting the GPS position will allow the Magellan RoadMate to compute which satellites are available and calculate the position quicker.

1. From page 2 of the Main Menu, tap **User Options**.

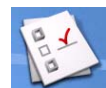

2. Tap **GPS Options**.
3. Tap **Set GPS Position**.
4. Follow the prompts to enter the address where you currently are.
5. Tap **Done** when finished entering the address.

Backing Up and Restoring Data

Backup and restore provides a way of storing the address book and other data to a SD/MMC card. When the data has been backed up, it can be restored at any time. Please note that when you restore from backed up data, address book and other data will be replaced with the data. The Magellan RoadMate cannot append backed up data to your existing data.

Backing Up Data

1. From page 2 of the Main Menu, tap **User Options**. 
2. Insert a SD or MMC card with available space into the SD slot of the Magellan RoadMate. Note that backing up data will overwrite any back up files on the SD or MMC card.
3. Tap **Backup and Restore**.
4. Tap **Backup**.
5. Confirm backup. Tap **Yes**.
6. Operation successful! Tap **OK**.
7. Tap **Back** arrow to exit.

Restoring Data

1. From page 2 of the Main Menu, tap **User Options**. 
2. Insert a SD or MMC card with available space into the SD slot of the Magellan RoadMate. Note that backing up data will overwrite any back up files on the SD or MMC card.
3. Tap **Backup and Restore**.
4. Tap **Restore**.
5. Confirm restore. Tap **Yes**.
6. Operation successful! Tap **OK**.
7. Tap **Back** arrow to exit.

Viewing Map Information

1. From page 2 of the Main Menu, tap **User Options**. 

2. Tap **Map Information**.
3. Tap **Back** arrow to exit.



Map Information	
Geographic Area:	USA
Basemap NavStreets version:	27
Detailed map NavStreets version:	27
Map Library Version:	v.36
Navigator Build Date:	Feb 28 2007

Map Information Screen