

# Haier

## PLASMA TV OWNER`S MANUAL MODELS: **P42SV6-C1** **P42S6A-C2**

Please READ this manual carefully  
before operating the unit, and keep  
it for future reference.



Haier

# CONTENT

## **BEFORE OPERATING**

Warning.....	1
Important Safety Instructions.....	2
Buttons and interface location.....	4
Remote controller.....	6
Remote controller key function.....	7
Effective range of remote controller.....	8
External equipment connections.....	9

## **BASIC OPERATING**

Switching on/off the TV set.....	12
Watching TV program.....	13
Searching channel.....	15
Picture control functions.....	18
Sound control functions.....	19
Time functions.....	21
Multiple aspect ratio and language.....	23
Multiple OSD position.....	24
Calendar search and time skip.....	25

## **OTHERS**

Others functions.....	26
PC setting.....	27
Specifications and functions.....	29
Troubleshooting.....	30

## **Accessories**



Remote controller



User's manual



Alkaline battery(AA)×2



Power cable

# Warning



## WARNING

RISK OF ELECTRIC SHOCK  
DO NOT OPEN



### WARNING

TO REDUCE THE RISK OF ELECTRIC SHOCK DO NOT REMOVE COVER (OR BACK). NO USER SERVICEABLE PARTS INSIDE. REFER TO QUALIFIED SERVICE PERSONNEL.

\*To avoid electric hazards, it is strongly suggested that the back cover not be opened, as there is no any accessory inside the casing.

\*If necessary, please contact authorized after-sales services.

\*A lightning flash mark in a triangle: A potentially hazardous situation, which, if not avoided, could result in serious injury by high voltage.

\*An exclamation mark in a triangle: Major part or accessory of which technical specifications must be followed if it is to be replaced.

### Warning:

To avoid fire or electric hazards, never place your television receiver in an area with heavy moisture. Attention should be paid to avoid accidental scratches or impacts onto the PDP screen.

### Caution:

- ▲ Please read this manual carefully before using your television and keep this manual in a good place for future reference.
- ▲ To achieve the best performance of your television, read this User's Manual carefully and properly store it for future reference.
- ▲ Information of screen displays and figures in the User's Manual may vary due to technical innovations.

### Caution:

Unauthorized disassembly of this product is prohibited.

# Important Safety Instructions

The product should be tightly fixed to avoid drop damages and even fire.



To avoid fire hazards, do not use this product under direct sunlight or closely to heat sources.

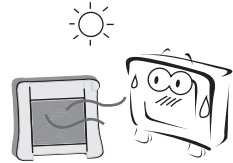

Do not locate the product close to water or oil, which may cause fire hazards.

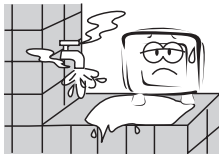

Unplug the power supply and antenna of the product when there is a rainstorm, especially Thunderstorm.

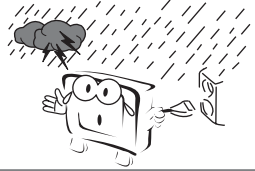

Do not use damaged or worn electric plugs, and keep electric cord away from heat sources to avoid electric shocks or fire hazards.



Do not connect excessive sockets in parallel or share the same socket by multiple plugs to avoid fire hazards.

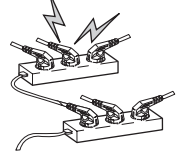

The product must be placed on a solid and stable surface to avoid collapse.

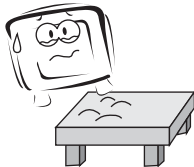

Unauthorized disassembly of the television is prohibited to avoid electric shocks or fire hazards. Contact authorized after-sales service if technical service is needed.

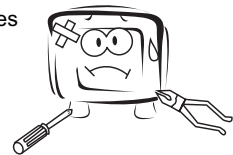

Keep the product away from a transformer or heat source to avoid fire hazards.

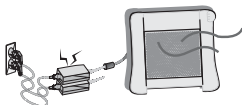

Disconnect the product from power supply and contact authorized after-sales service if abnormal sound is heard in the product.

# Important Safety Instructions

Don't use or store inflammable materials near the product to avoid explosion or fire hazards.

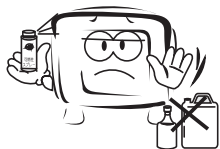

Don't place the product in a humid area to avoid fire hazards.

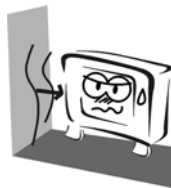

The antenna of the product should be away from electric cable to avoid electric shocks.

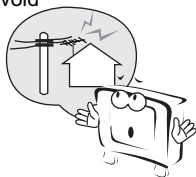

Never touch the plug when your hand is wet as this might cause electric shocks.

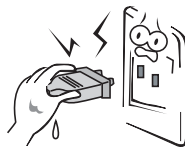

Always make sure that the television is well plugged as poor electric connection might cause fire.

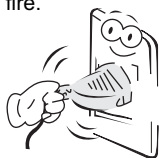

When antenna is used, measures should be taken to prevent water from flowing down along the cable into the television.



Unplug the television, use soft fabric, never chemicals, if you are going to make cleaning of the product. Make sure that no water drops in the product.



The plug and electric cable must be kept clean to avoid electric shocks or fire hazards.

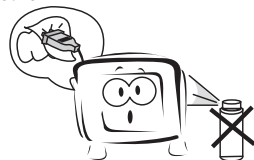

Disconnect the television from power supply and antenna when there is a rainstorm or thunderstorm to avoid electric shocks or fire hazards.



Disconnect the television from power supply to avoid electric shocks or fire hazards in a long vacation.

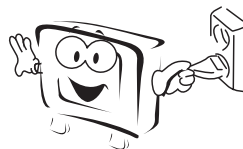

# Buttons and interface location

- This is a simplified representation of front panel.
- Here shown may be somewhat different from your TV.

## Front panel Control

P42SV6-C1



P42S6A-C2

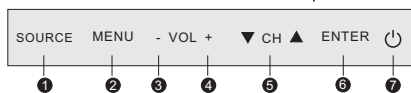

## Buttons and functions

### 1、 Input signal option:

selection of input signals of TV, VIDEO, S-Video, YUV, PC and DVI sources.

### 2、 Menu button

### 3、 Volume decrease:

for lowering the volume or adjusting the menu.

### 4、 Volume increase:

for enhancing the volume or adjusting the menu.

### 5、 Channel number increase and decrease.

### 6、 Option confirmation.

### 7、 Power button

for turning on or off the power supply.

# Buttons and interface location

## Rear panel Control

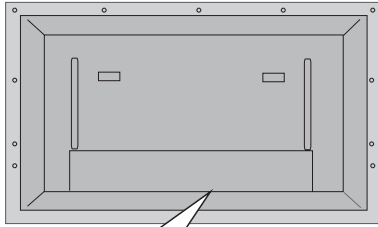

### PC VIDEO Input

Connect the monitor output connector from a PC to the jack

### DVD/DTV Input (Component)

Connect a component video/audiodevice to these jacks.

### Power Cord Socket and switch

This TV operates on AC power. The voltage is indicated on the Specifications page. Never attempt to operate the TV on DC power

### Video output terminal

Connect ordinary video/audio or other appliance audio input terminals.

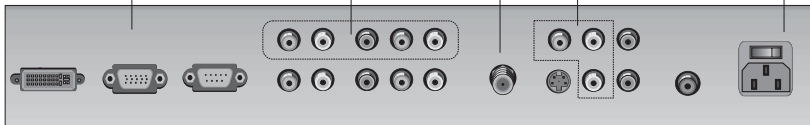

### DVI Input

Connect the monitor output connector from a PC to the appropriate input port.

### Audio input

for linking DVI, PC or other appliance audio output terminals.

### Audio/Video Input

Connect audio/video output from an external device to these jacks.

### EXT Subwoofer:

Subwoofer audio output terminal.

### RS-232 INPUT (CONTROL/SERVICE) PORT

Connect to the RS-232 port on a PC.

### External Speaker (8 ohm Output)

Connect to optional external speaker(s).

### S-Video Input

Connect S-Video out from an S-VIDEO device to the S-VIDEO input.

# Remote controller

## Battery loading

1. Slide open the cover of the battery compartment on the back of the remote controller.
2. Load two 5# alkaline batteries in the compartment. (plus and minus poles to respective mark)
3. Replace the cover of the battery compartment.

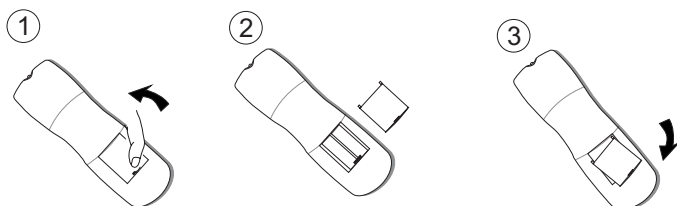

## Precautions

As strong light may interfere the signals, change your position to operate the remote controller if the television cannot be turned on or off as you expect.



Make sure that two 5# 1.5V alkaline batteries are loaded. The batteries must be of the same type. The batteries must be located properly. The batteries are not rechargeable.

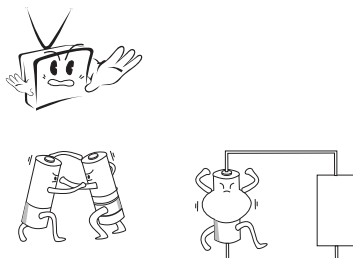

Keep the remote controller away from heat source or humid area to ensure effective performance of the remote controller.

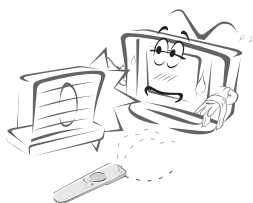

Make sure that there is no obstacle between the remote controller and television set.

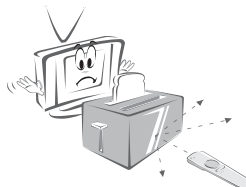



# Remote controller key function

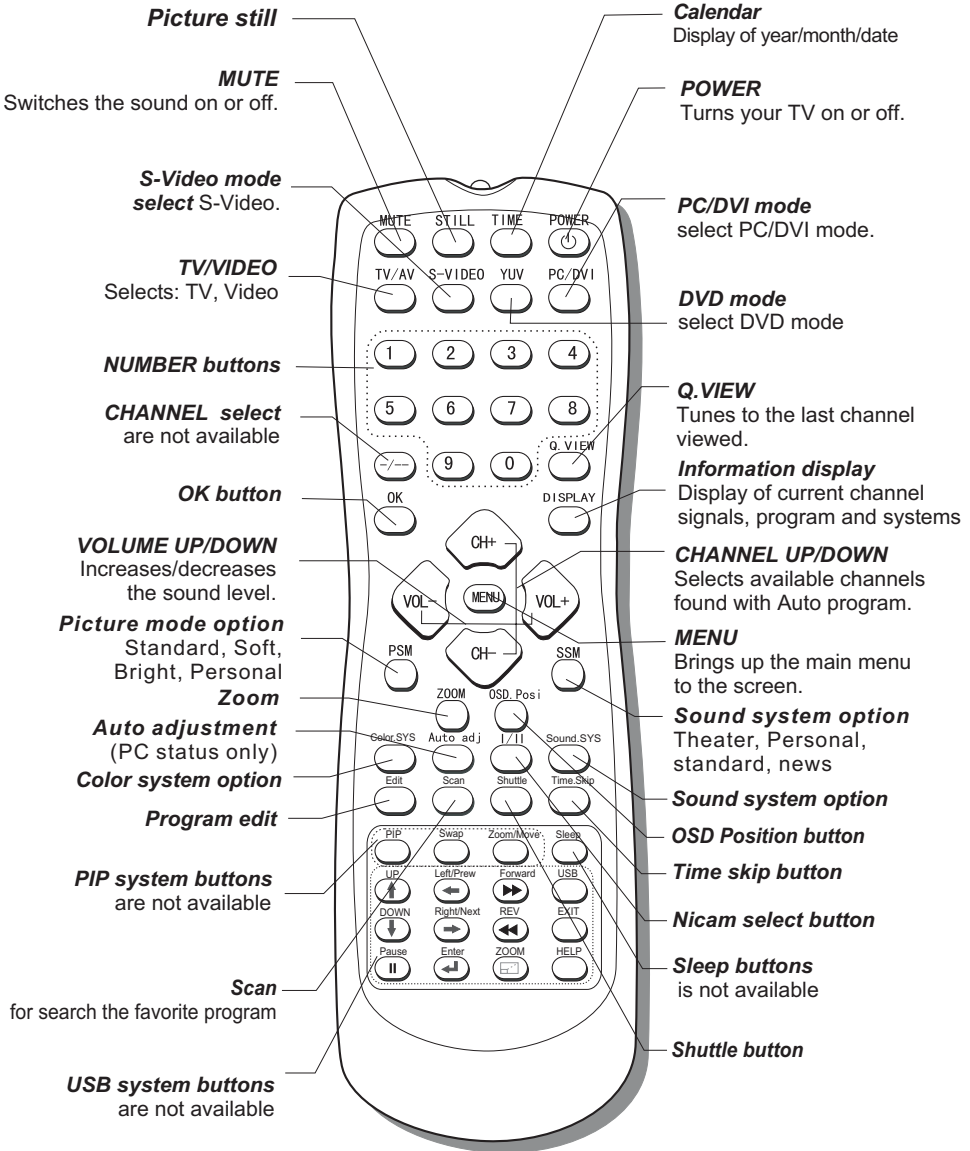

# Effective range of remote controller

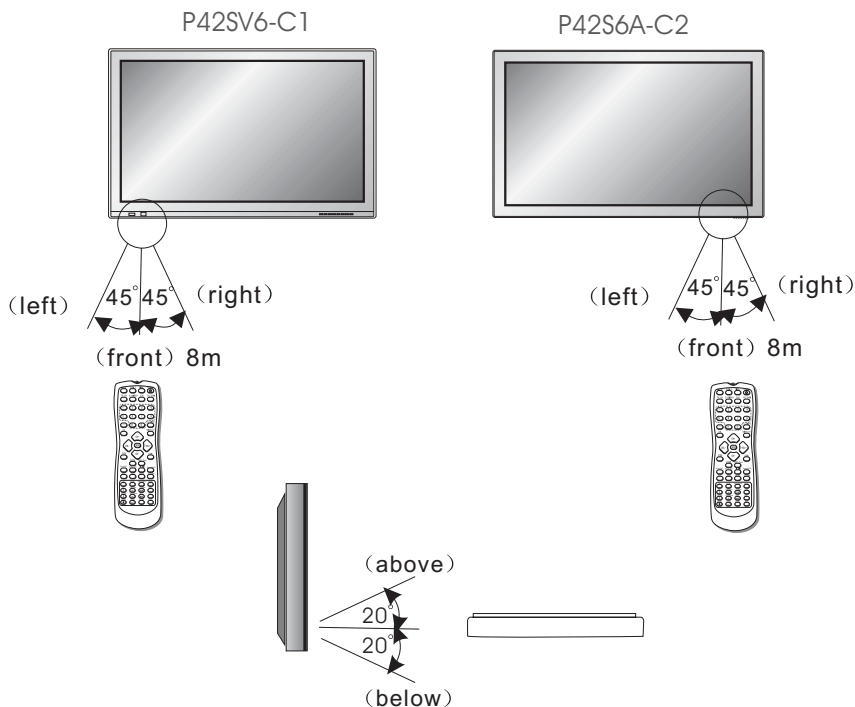

- Ensure the remote controller is pointed toward the remote controller windows on the display.
- No obstacles should be placed between the remote controller and the remote controller window.
- The effective receiving scope for the signal is 8 meters to the front of the remote controller windows, and 45° to the left or right side and 20° above or below the control windows.

## Use of remote controller:

1. To ensure a normal operation, the remote controller should not be dropped or damaged in any way . It should also be kept dry and away from all heat sources.
2. Battery replacement is necessary when the remote controller acts inconsistently or stops operating the plasma display.

# External Equipment Connections

## Antenna Connection

- Antenna or Cable Service without a Cable Box Connections
- For optimum picture quality, adjust antenna direction if needed.

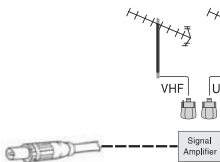
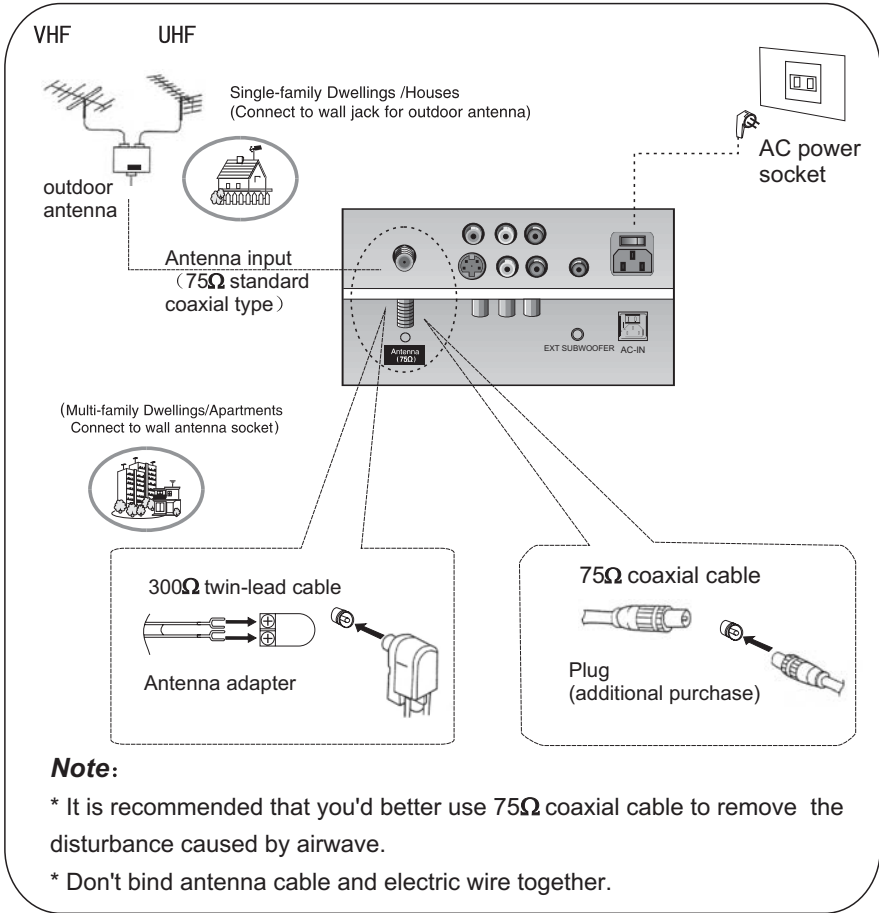

- To improve picture quality in a poor signal area, purchase and install a signal amplifier.
- If the antenna needs to be split for two Tv's, install a "2-Way Signal Splitter" in the connections.
- If the antenna is not installed properly, contact your dealer for assistance.

# External Equipment Connections

## DVD setup

### How to connect

1. Connect the DVD video outputs (Y, Pb/Cb, Pr/Cr) to the COMPONENT (Y, Pb/Cb, Pr/Cr) INPUT jacks on the TV and connect the DVD audio outputs to the AUDIO INPUT jacks on the TV, as shown in the figure.

2. If your DVD only has an S-Video output jack, connect this to the S-VIDEO input on the TV and Connect the DVD audio outputs to the AUDIO INPUT jacks on the TV, as shown in the figure.

**NOTE:** If your DVD player does not have component video output, use S-Video.

### How to use

1. Turn on the DVD player, insert a DVD.
2. Use the S-Video button on the remote control to select S-VIDEO mode.
3. Press Play button on external equipment for program play.
4. Refer to the DVD player's manual for operating instructions.

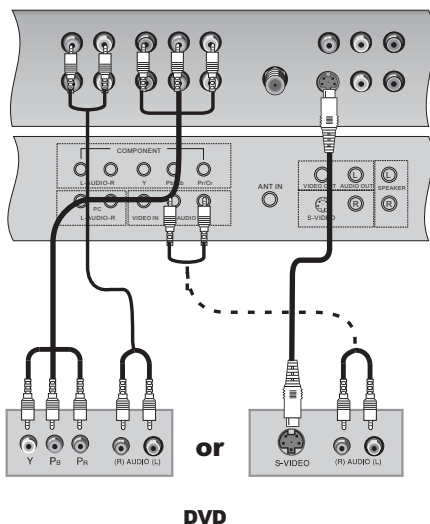

## DTV setup

-To watch digitally broadcast programs, purchase and connect a digital set-top box.

### How to connect

Use the TV's COMPONENT (Y, Pb/Cb, Pr/Cr) INPUT jacks, RGB or DVI port for video connections, depending on your set-top box connections available. Then, make the corresponding audio connections.

### How to use

1. Turn on the digital set-top box. (Refer to the owner's manual for the digital set-top box.)
2. Use YUV on the remote control to select YUV (Y, Pb/Cb, Pr/Cr) mode.
3. Press Play button on external equipment for program play.

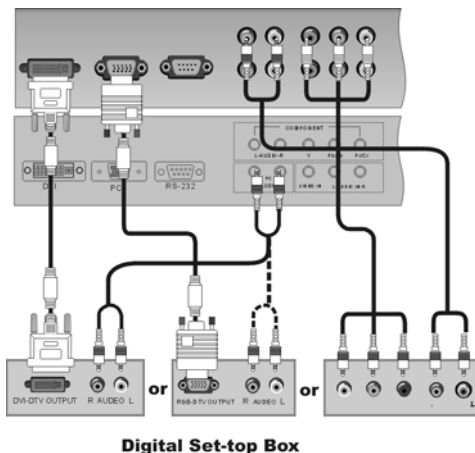



# Switching ON/OFF the TV set

In the manual, the OSD (on screen display) may be different from your TV's because it is just an example to help you with the TV operation.

## Power ON/OFF

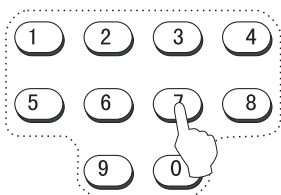
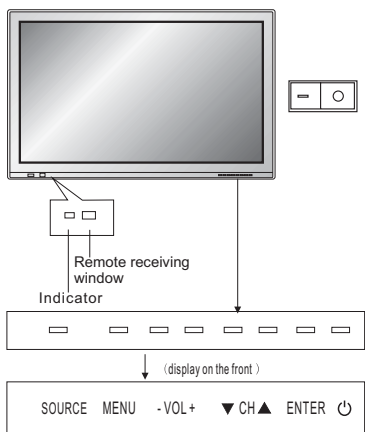

## Switching ON/OFF the TV set

1 Please press down the power switch to switch on AC power supply and the power indicator will light.

2 If the indicator is lighting in red, press button  on the remote control again.

1

3 If you want to exchange to standing by status, please press down button  on the remote controller.

4 If you want to fully switch off the power supply for the TV set, please press down the power switch button on the TV set.

## Auto switch-off function

If an empty channel is selected or the TV programs are ended for the day, the power will be switched off 5 minutes later automatically. If the "OFF TIME" is setting, it will be switched off according to the presetting time.

**(Note: If the "Off timer" is less than 5 minutes, it will be switched off automatically to the presetting time. )**

# Watching TV Program

You can watch TV program in a presetting channel.

## Watching TV program

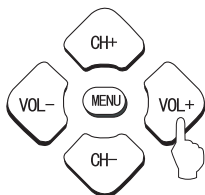
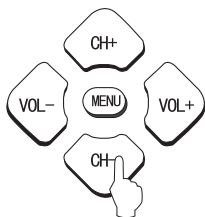
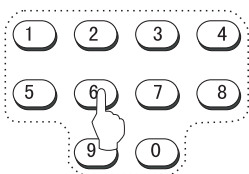
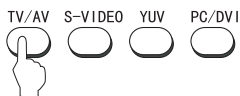

### To select the TV mode

Before watching TV program, you may ensure your tv in TV mode.

Press TV/AV button to select tv mode.

### How to select the desired program

#### 1 Using "Program number" buttons.

- Directly enter the channel number with the numeric keypad on the remote control.
- To select channel numbers from 10 ~ 99 ,press continuously the numeric buttons.

#### 2 Using the CH+/- buttons.

- Press the CH+ button to select a channel number in number increasing direction.
- Press the CH- button to select a channel number in number decreasing direction.

#### 3 Using Prog. NO. Function.

Press the MENU button and VOL+/- button, till picture menu shown on the right display on the screen.

- Press the VOL+ button to select a channel number in number increasing direction.
- Press the VOL- button to select a channel number in number decreasing direction.

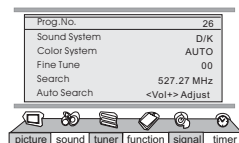

### How to select the desired sound

Press the VOL-/+ buttons on the remote or the front of the TV set to adjust the volume level. The range is 0~100.

When the volume buttons are pressed the volume level is displayed automatically on the TV screen.

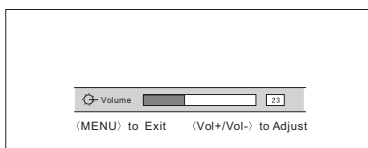

# Watching TV Program (continued)

## Watching TV program

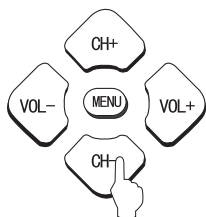

### If the colour of some channel is abnormal

Usually colour system should be set in the auto position. However if the colour displayed on the screen are incorrect, you can manually select the correct colour system.

Press the menu and VOL+/- button, till the picture menu shown on the right will display on the screen.

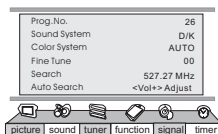

### If picture color is abnormal

Press the CH+/- buttons to select "color system", then press the VOL+/- buttons to select the correct color system. In general, you can set it as "AUTO".

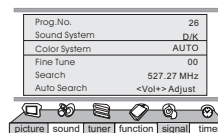

### If sound is abnormal

Press the CH+/- buttons to select "sound system", then press the VOL+/- buttons to select the correct sound system.

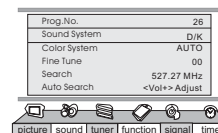

## Program review

Swap function enables quick swap to the last watched program.

**1** Suppose the channel number you used just now is 8 and the channel number you are using is 18 (as shown in the figure).



**2** If you want to return to the last watched program channel 8, you can simply press the Q.View button.



**3** If you want to return to channel 18, press the button again. Through this function, you can easily change between the channel you are using and the channel you used last time.



Q. VIEW





# Searching Channel

- This TV set has three methods to set channels, which are respectively full automatic, manual search、 fine tune.
- In this section, how to use the remote control to set channel is explained. You can also use buttons on the TV set to set channel.

## Full automatic search mode

### Automatic search

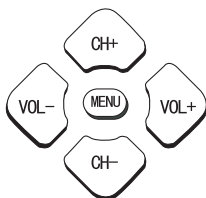

1 Press the MENU button and VOL+/- button, till tuner menu shown on the right display on the screen.

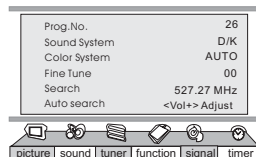

**Note** : the tuner menu will be only operated in normal TV mode.

2 Press the CH+/- buttons to select "Auto Search" item.

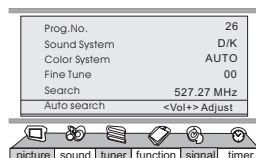

3 Press the VOL+ button to ensure automatic search function work.

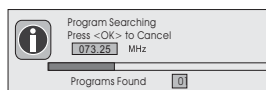

After the search has finished, the Program Table will display on the screen.

All channels now playing program will be automatically preset in order.

Program Table				
00 @0497	10	----	20	----
01 @0622	11	----	21	----
02 @0832	12	----	22	----
03 @1442	13	----	23	----
04 @1842	14	----	24	----
05 @2112	15	----	25	----
06 @2322	16	----	26	----
07	----	----	27	----
08	----	----	28	----
09	----	----	29	----

(Vol+/Vol- Ch+/Ch-) to Select Program  
1 = Del 2 = Change 3 = Rename 4 = Favorite 5 = Skip

# Manual search

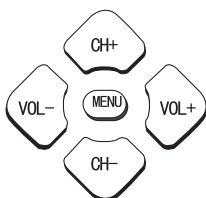
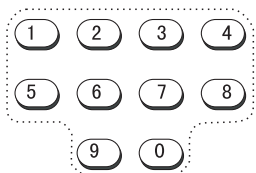

## Manual search

**1** Press the CH+/- buttons or the PROGRAM NUMBER (0-9) button to choose desired channels (regard channel 1 as example) .

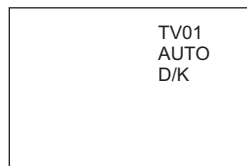

**2** Press the MENU button and VOL+/- button, till the **tuner** menu shown on the right display on the screen.

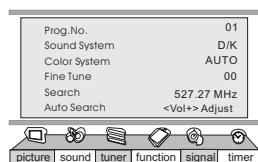

**3** Press the CH+/- buttons to select " Search" item.

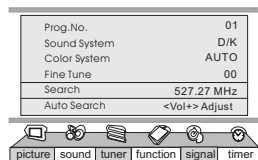

**4** Press the VOL-/+ buttons to start searching.

The VOL- (down) button is used for lower side program search.

The VOL+ (up) button is used for higher side program search.

Repeat this step, till find the desired channel.

## Fine tune

### Fine tune

If the picture or sound are poor, try using the FINE TUNE feature. Do not use this feature unless reception is poor.

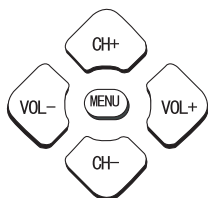

- 1 Press the CH+/- buttons or NUMBER (0-9) button to choose desired channels (regard channel 8 as example).

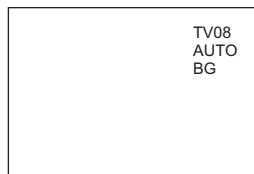

- 2 Press the MENU button and VOL+/- button, till the **tuner menu** shown on the right display on the screen.

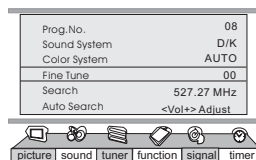

- 3 Press the CH+/- buttons to select "**Fine Tune**" item.

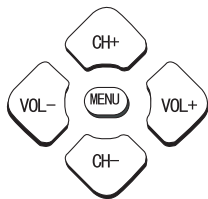

- 4 Press the VOL-/+ buttons all through to carry out fine tune, till the best picture and sound are obtained, then loosen the button.

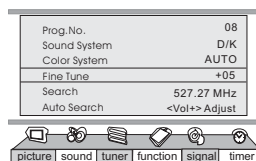

# Picture Control Functions

## Multiple picture modes

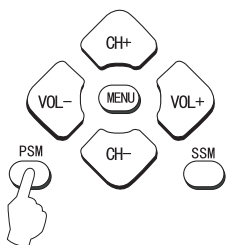

### How to select picture modes

You can quickly select the desired picture mode from three preset modes and one customized mode.

Press the PSM button to select the desired picture quality. Four kinds of picture modes (i.e., "Standard", "Soft", "Bright", "Personal", ) can be selected in turn.

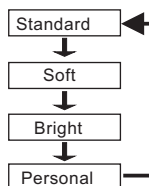

The 4 modes are

Picture mode	Picture quality
Personal	A spare setting that can be adjusted to personal tastes
Standard	Designed for rooms that have good all round lighting
Soft	Designed for nighttime low lightviewing
Bright	Designed for rooms with high ambient lighting such as daytime sport;

### How to customize your own picture status

1 Press the MENU button and VOL+/- button , till the **picture** menu shown on the right display on the screen.

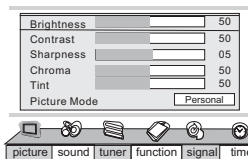

2 Press the CH+/- buttons to select the item to adjusted, then press the VOL+/- buttons to obtain the desired effect.

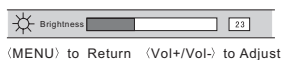

ITEM	Press VOL-	Press VOL+
Brightness	Dark	Bright
Contrast	Weak	Strong
Sharpness	Soft	Sharp
Chroma	Shallow	Deep
Tint(only in NTSC mode)	More purple	More green

**NOTE :** these items are adjustable only under the "personal" setting.

# Sound Control Functions

## Multiple sound modes

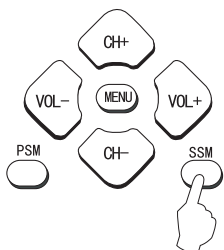

### How to choose sound mode

Press the SSM button to select the desired sound quality. Four kinds of sound modes (i.e., “Theater”, “Personal”, “Standard” and “News”) can be selected in turn.

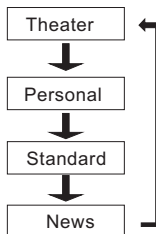

Sound mode	Sound quality
Personal	A spare setting that can be adjusted to personal tastes
Standard	normal sound with moderate bass and treble setting
News	Designed to reduce the bass and treble which enhances the voice for news programs
Theater	Enables extra bass and treble to enhance the movie experience;

### How to customize you own sound quality

1 Press the MENU button and VOL+/- button, till the **sound** menu shown on the right display on the screen.

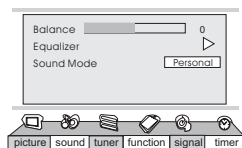

2 Press the CH+/- buttons to move select the item to be adjusted, then press the VOL-/+ buttons to obtain the desired effect.

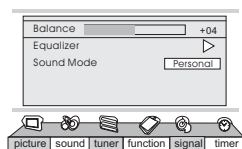

ITEM	Press VOL-	Press VOL+
Balance	R down	L down

**NOTE :** these items are adjustable only under the “personal” setting.

## Equalizer and mute

### How to use Equalizer

1 Press the MENU and VOL+/VOL- button, till the sound menu shown on the right display on the screen.

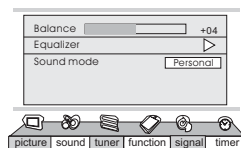

2 Press the CH+/- buttons to select "Equalizer", then press the VOL+ buttons, the menu shown on the right display on the screen.

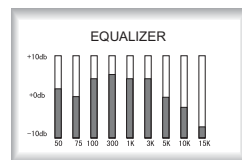

3 Press the VOL+/- buttons to select frequency to adjust, then press the CH+/- buttons to adjust the value data.

### How to eliminate sound

When you need to pay attention to surrounded sounds, or there is a telephone calling you or there are some guests visiting you, the sound elimination (mute) function is very convenient.

1 Press the MUTE button on the remote control and "MUTE" type face will display on the lower part of the screen. At this time, the sound of the TV set is turned off.

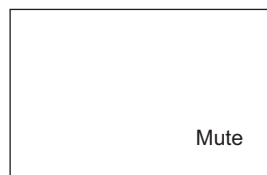

2 If you want to recover the sound, press the MUTE button again or directly press the VOL-/+ buttons.

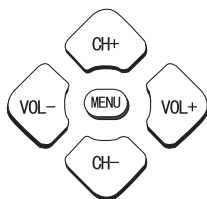

# Time Functions

## Clock setting and timer on/off functions

### Clock setting

The clock will only work if the TV set is turned on or in standby. When the set is disconnect from the power supply or is turned off by the main power on the rear panel, the clock loses power and will need to be reset when the power is reconnected.

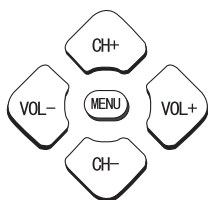

1 Press the MENU button and VOL+/- button, and the **timer** menu display on the screen.

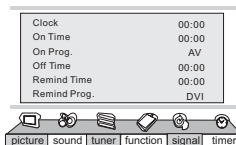

2 Press the CH+/- buttons select "**Clock**", press the VOL -/+ buttons to select hour position; then press the CH+/- buttons to set the value of hour; press again the VOL +/- buttons to select the minutes position, then press the CH+/- buttons to set the value of minute.

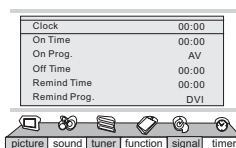

### On/off timer

Using on/off timer function, the TV set can automatically turn on to a preset program or shut down in a preset time.

1 Press the MENU and VOL+/- button to call up the **timer** menu on the screen.

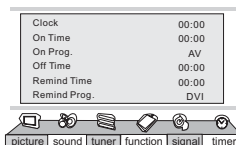

2 Press the CH+/- buttons to select "On time", press the VOL-/++buttons to select hour position; then press the CH+/- buttons to set the value of hours; press again the VOL +/- buttons to select the minute position, then press the CH+/- buttons to set the value of minute..(take 18:00 as an example)

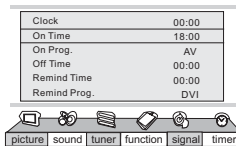

3 Press the CH+/- buttons to select "On prog", then press the VOL-/++ or program direct number buttons to select your desired channel (take 8 as an example).

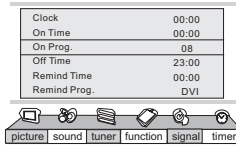

4 Repeat step 1-2 to set " Off time " .(take 23:00 as an example)

# Time Functions

## Remind Time and Remind Program setting

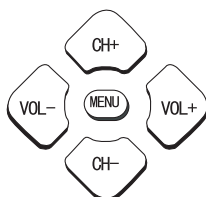

### How to use the remind time and program

Program remind timer, that displays an on-screen reminder prompt, when a program on a different channel is due to start.

**1** Press the MENU and VOL+/- button to call up the **timer** menu on the screen.

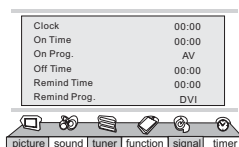

**2** Press the CH+/- buttons to select "Remind Time", then press the VOL +/- buttons to select hour position; then press CH+/- to set the value of hour. Repeat 2 step to select the minute position and set the value of the minute.(take 19:30 as an example)

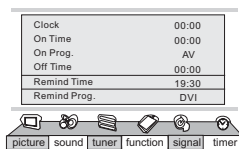

**3** Press the CH+/- buttons to move the cursor to "REMIND PROG", then press the VOL +/- buttons or the program direct number buttons to set the desired channel or source (take DVI as an example).

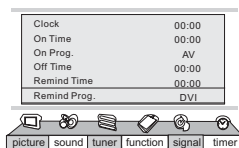

**NOTE :** the Tv offers multi-remind program.

I.e., "PC", "AV", "SV", "DVI", "YUV", "00", "01", "02",....."99") can be selected in turn.



# Multiple aspect ratio and language

## Multiple aspect ratio and language setting

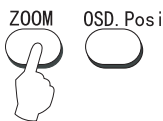

### How to choose picture aspect ratio

#### 1 Using “ZOOM” button.

Press the ZOOM button to select the desired picture ratio. Four kinds of aspect ratio modes (i.e., “Fill all”, “Normal”, “Wide” and “Zoom”) can be selected in turn.

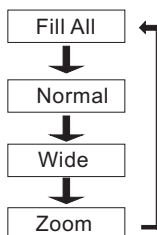

Aspect ratio	Picture effect
Fill all	no cut out on input signal ,screen is filled by picture
Normal	no cut out on input signal , picture with un-changed scale displayed on the screen (to keep the scale, maybe only the center area of the screen is active)
Wide	input signal is vertically cut out by 10% and picture's center area is non-linear zoomed to fill the whole screen
Zoom	input signal is vertically cut out by 15.3%, no non-linear zoomed to fill the screen

#### 2 Using the MENU button.

1 Press the MENU button and VOL+/- button , till the **function** menu shown on the right display on the screen.

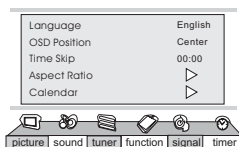
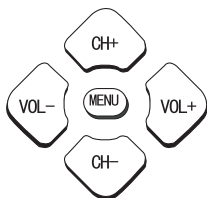

2 Press the CH+/- buttons to select “ **Aspect Ratio** ” item, then press the VOL+ buttons to select the item to desired.

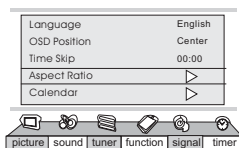

# Multiple OSD position

## Multiple OSD position setting

### How to choose OSD position

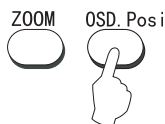

#### 1 Using "OSD posi" button.

Press the "OSD posi" button to select the desired picture position. Five kinds of position modes (i.e., "Center", "Left T", "Right T", "Right B" and "Left B") can be selected in turn.

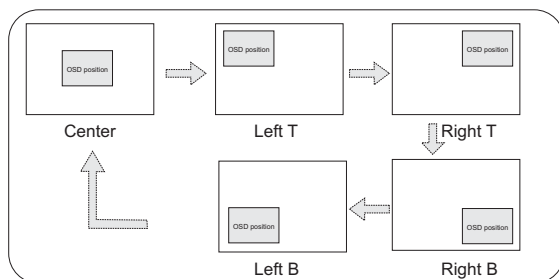

#### 2 Using the MENU button.

1 Press the MENU button and VOL+/- button, till the **function** menu shown on the right display on the screen.

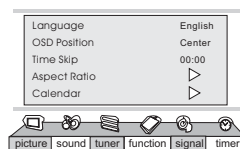

2 Press the CH+/- buttons to select "OSD Position" item, then press the VOL+ buttons to select the item to desired position.

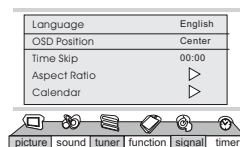

# Calendar search and time skip

This TV set has been designed to search the calendar from the year 1900 to 2100.

## Calendar search and time skip

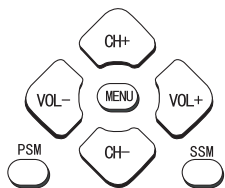
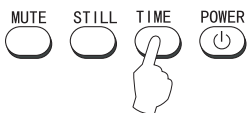

### To choose calendar search

1 Press the MENU button and VOL+/- button, till the **function** menu shown on the right display on the screen.

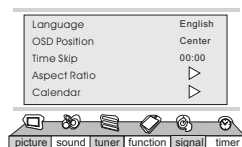

2 Press the CH+/- buttons to select "**Calendar**" item, then press the VOL+ buttons to display the calendar menu on the screen.

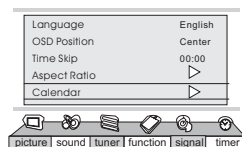

3. Press VOL+ button to search the desired year or month.



4. Press CH+/- button to adjust the desired year or month.

5. Press the TIME button to return to previous mode.

### To choose time skip function

Repeat step 1. to select "**Time Skip**" item, then press the VOL+/- buttons to set the desired time.

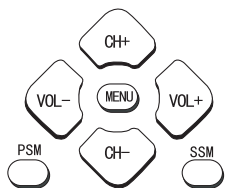
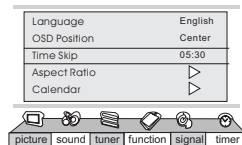

# Others functions

## Program Edit、Scan、Nicam and display functions

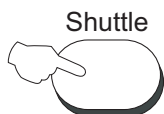
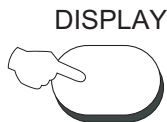
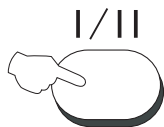
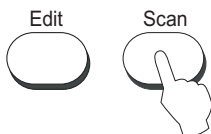
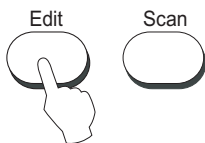

### Program edit and Scan

1 Press the Edit button, the Program Table display on the screen.

Program Table			
00 @0497	10	----	20
01 @0622	11	----	21
02 @0832	12	----	22
03 @1442	13	----	23
04 @1842	14	----	24
05 @2112	15	----	25
06 @2322	16	----	26
07	----	17	----
08	----	18	----
09	----	19	----

(Vol+Vol- Ch+(Ch-) to Select Program  
1=Del 2=Change 3=Rename 4=Favorite 5=Skip

2 Press CH+/- or VOL+/- button to select program, then press the number button 4 to set favorite program.

3 Repeat step 2 you may set multiple favorite program.



4 Press SCAN button to enjoy desired program.

### NICAM

Press the I/II button will result in fast swap of **NICAM** function of current program.

### Display function

Press the DISPLAY button, then the channel number and system will be displayed on the screen. Press the DISPLAY button again, it is disappear.

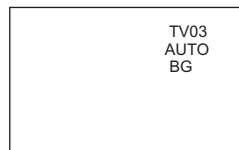

### Shuttle function

Shuttle function enables quick swap to setting program.

Press Shuttle button about 3 second, and the display **Shuttle** on the screen, at the time, you may operate other, then if you scan over program, you may press again shuttle button to return to the setting program.

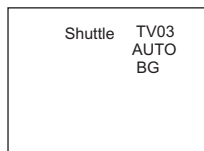

# PC setting

## PC setting

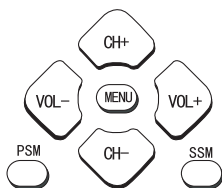
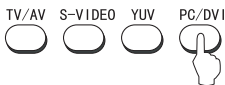

### PC setting

Press PV/DVI button to select PC mode.

1 Press the MENU button and VOL+/- button, till the signal menu shown on the right display on the screen.

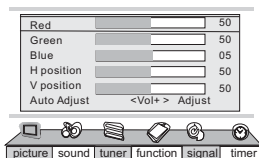

2 Press the CH+/- buttons to select the item to adjusted, then press the VOL+/- buttons to adjust.

ITEM	Press VOL-	Press VOL+
Red	Weaker	Stronger
Green	Weaker	Stronger
Blue	Weaker	Stronger

### Note

Recommendatory frequency as follow:

Sequence	frequency	H-frequency (KHz)	V-frequency (Hz)	Remark
1	640*480@60Hz	31.5	60	DOS
2	800*600@60Hz	37.88	60	VESA
3	1024*768@60Hz	48.36	60	VESA

*NOTE : As the frequency of display differ in PC device, you may select the appropriate frequency to obtain desired effect. If the signal of receive is excess, the picture can not be displayed or wrong on the screen.*

# PC setting (continued)

In VGA and DVI input mode, H-Position and V-Position can be adjusted to eliminate transverse line interference.

## Multiple picture position setting

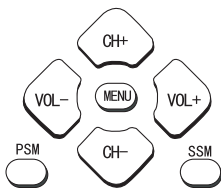
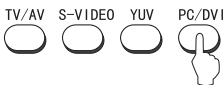

### PC setting

1 Press the MENU button and VOL+/- button, till the signal menu shown on the right display on the screen.

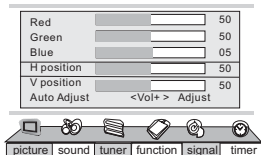

2 Press the CH+/- buttons to select the item to adjusted, then press the VOL+/- buttons to obtain the desired effect.

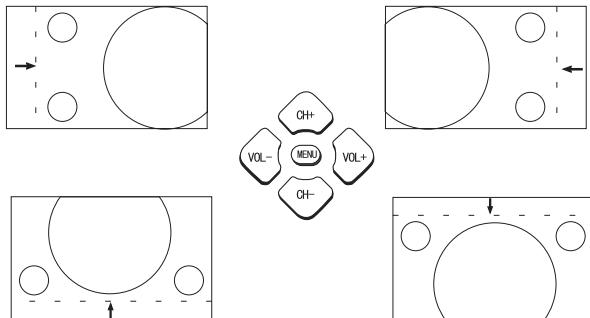

#### Note:

1. As adjusting H position or V position parameter, It is natural that the picture will have faintness once in a while if the range is more, then to adjust contrarily to normal position.
2. H-position, V-position, Auto Adjust are not available in TV mode, AV and S-VIDEO mode.
3. Auto Adjust is only available in PC/DVI mode.

# Specifications and functions

Screen diagonal line 42 inches  
 Picture proportions 4:3/16:9:(4 modes)  
 Panorama picture: 16:9  
 Picture element: 852×480  
 Contrast: 10000:1  
 Brightness: 1500cd/m<sup>2</sup>  
 Multi-input compatibility  
 Advanced technology for motion picture processing  
 Two 7W speakers/optional

Complex component: RCA-pin×3  
 Component video signal: YUV×1  
 S terminal: Mini DIN 4-pin×1  
 RGB input: D-sub 15-pin×1 (480i/p, 720p, 1080i)  
 Audio input: RCA-pin TYPE (L/R)×3: full support  
 separate audio frequency input  
 Audio system: stereo  
 Control port: RS-232 D-sub 9-pin×1

Model	P42SV6-C1	P42S6A-C2
Size: (WXHxD) unit:mm main component	1050 x 664 x 88	1055 x 654 x 86
Working conditions	~150V-240V, 50/60Hz	~150V-240V, 50/60Hz
Power consumption	≤380W	≤380W

## Temperature

Working: 0°C~35°C (32°F~90°F) Storage: -15°C~60°C (5°F~140°F)

## Humidity

Working: 20~70% Storage: 20~80%

## Pressure

Working: 800~1114hpa Storage: 600~1114hPa

# Troubleshooting

For the sake of time and cost, it is strongly recommended that you check out the problem by yourself according to the instructions listed hereunder before contacting the after-sales service for technical assistance.

Problem	Possible remedies
No picture, no sound	Turn on the power supply; Properly plug the TV set to the power socket; Check to see if the power cable of other appliance is plugged in the TV set. Make sure that the power cable of the TV set is properly connected.
Good picture, no sound	Depress the volume button; Check out the audio frequency input signals.
Failure of remote controller	Check to see if the remote controller and plasma display receiving window are blocked by other objects and if batteries are properly loaded.
No color, weak color or poor picture	Designate the item of color from the Picture menu and depress the volume button; Keep the display and VCR separate a reasonable space; Activate some functions to store picture brightness; Make sure that the display and signal source are available and turned on.
Excessive brightness or darkness	Adjust brightness or contrast.
Picture too big or small	Adjust the setup of sizes.
One speaker failure	Balance the sound in the menu.
Slight sound from display	It is a normal phenomenon.

**Note:** Do not leave the television with static picture in an extended period as it may result in residual image on your television screen.

**Note:** Production of the plasma screen requires high and precision technologies. However, there might be some dark or bright (red, blue or green) spots, or some anomalistic stripes or spots. This is not defect. If the TV set is used in an area 2,400 meters above the sea level where the air pressure is below 750hpa, the picture on the plasma screen may be affected and a muffled sound might be produced. These phenomena might happen in the area 1,500 meters above the sea level. This is resulted from difference between air pressures inside and outside the display. This is not a defect covered by the limited warranty.

## NOTE

Design and specifications are subject to change without notice.  
The dimension in this manual is a approximation.



# Haier

Haier

04  
0090506941