

STARFIRE™ Real Time Kinematic (RTK)



JOHN DEERE

INSTALLATION INSTRUCTIONS STARFIRE Real Time Kinematic (RTK)

PC20235 18DEC03 (ENGLISH)

**John Deere Ag Management Solutions
PC20235 (18DEC03)**

COPYRIGHT © 2003
DEERE & COMPANY
Moline, Illinois

All rights reserved
A John Deere ILLUSTRATION® Manual

PC20235-19-18DEC03

Introduction

IMPORTANT: Read through this instruction thoroughly and familiarize yourself with process before performing procedure.

This instruction covers installation of Real Time Kinematic (RTK) on your STARFIRE system.

OUO6084.0001B83 -19-08SEP03-1/1

Installation Time

Installation time of Real Time Kinematic (RTK) varies considerably depending on what receiver is being mounted to. Installation time will typically take between 1—3 hours with an average installation time of 1.5 hours.

OUO6043.00016F9 -19-30MAY03-1/1

Parts List

PF90258 Vehicle Bundle

- PF11579 Screws, Phillips #8-32, 7/16 in. (2 Used)
- PF80608 Radio
- PF80611 Harness, STARFIRE RTK Rover
- PF80623 Bracket STARFIRE
- PF80631 Antenna, Low Gain
- PF80677 Cable, Antenna Extension

PF90259 Base Station with Tripod and STARFIRE

- PF80610 Harness, STARFIRE RTK Base Station
- PF80625 Bracket, Tripod
- PF80629 RTK Radio Kit
- PF80632 Tripod
- PF80633 Harness, No TCM Plug
- PF80647 Harness, STARFIRE RTK Base Receiver
- PF80654 Assembly, Receiver and Radio
- PF80655 Case
- PF80656 Case Insert
- PF80657 Receiver, STARFIRE Gen. II
 - 21M7267 Screw, M6X20 (6 Used)
 - PC20234 Instruction, Licensing STARFIRE
 - PF10134 Cover, Upper GPS Receiver
 - PF10135 Cover, Lower GPS Receiver
 - PF80385 Position Receiver
 - PF80611 Harness, STARFIRE RTK Rover
 - PF80623 Bracket STARFIRE
- PF80660 Harness, Power Adaptor

PF90263 Base Station with Tripod, Less STARFIRE

- PF80610 Harness, STARFIRE RTK Base Station
- PF80623 Bracket STARFIRE
- PF80625 Bracket, Tripod
- PF80629 RTK Radio Kit
- PF80632 Tripod
- PF80633 Harness, No TCM Plug
- PF80647 Harness, STARFIRE RTK Base Receiver
- PF80655 Case
- PF80656 Case Insert
- PF80660 Harness, Power Adaptor

PF90260 Base Station with Universal Mounting Bracket and STARFIRE

- PF11621 Bracket, RTK Base Station Mount
- PF11622 Bracket, RTK Base Station Quick Tach
- PF80610 Harness, STARFIRE RTK Base Station
- PF80647 Harness, STARFIRE RTK Base Receiver
- PF80653 Bracket, RTK Base Station
- PF80654 Assembly, Receiver and Radio
- PF80660 Harness, Power Adaptor

PF90264 Base Station with Universal Mounting Bracket, Less STARFIRE

- PF80610 Harness, STARFIRE RTK Base Station
- PF80623 Bracket STARFIRE
- PF80629 RTK Radio Kit
- PF80633 Harness, No TCM Plug
- PF80647 Harness, STARFIRE RTK Base Receiver
- PF80653 Bracket, RTK Base Station
- PF80660 Harness, Power Adaptor

Attachments

- PF80632 Tripod
- PF80646 Harness, RTK Receiver Extension Harness
- PF80652 Harness, RTK Radio Extension Harness
- PF80653 Bracket, RTK Base Station
- PF90261 Repeater
 - Bolt, #8-1/2 in. Phillips (2 Used)
 - 19H1866 Bolt (2 Used)
 - N10217 Nut (2 Used)
 - PF11542 Bracket, Repeater
 - PF11614 Magnet (2 Used)
 - PF11625 Weld Nut
 - PF80608 RTK Radio
 - PF80609 Harness, STARFIRE RTK Repeater
 - PF80630 Assembly Repeater Bracket
 - PF80631 Antenna, Low Gain
 - PF80660 Harness, Power Adaptor
 - PF80666 Assembly, Repeater Magnetic Mount

Radio Installation

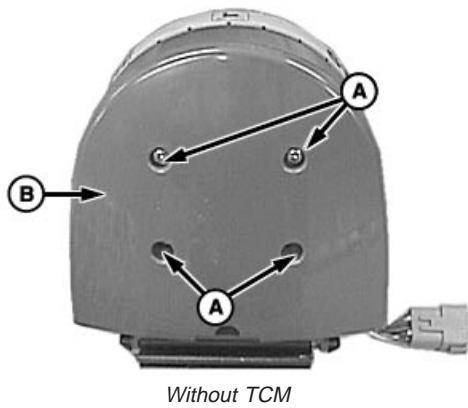

N64437 -UN-12DEC03

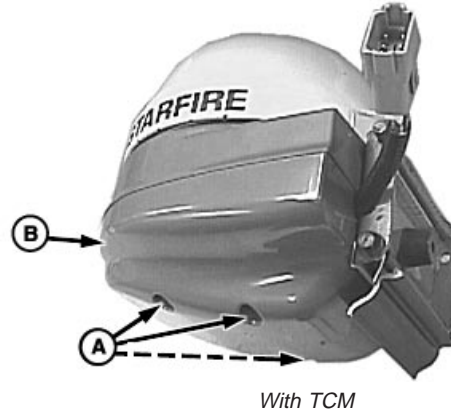

N64436 -UN-12DEC03

A—Screws (Four Used)

B—Shroud

1. Remove four screws (A) and lower shroud (B).

OOU6050,0000501 -19-16DEC03-1/11

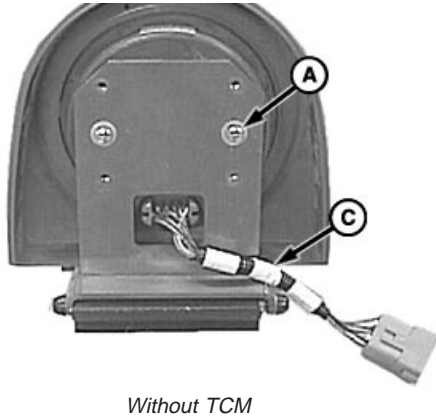

N64438 -UN-12DEC03

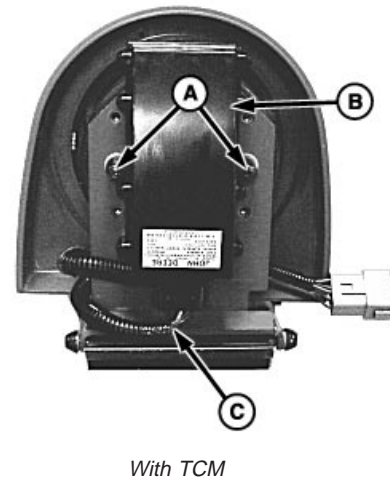

N64439 -UN-12DEC03

A—Screws (Two Used)

B—TCM

C—Harness

2. Remove screws (A).
3. Remove TCM (B)—if equipped.

4. Disconnect harness (C).
5. Discard harness and bracket.

Continued on next page

OOU6050,0000501 -19-16DEC03-2/11



Radio

N64441 -UN-18DEC03

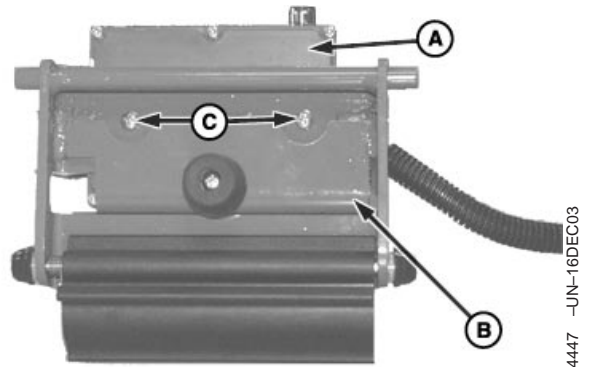

N64447 -UN-16DEC03

6. Attach radio (A) to new bracket (B) with 7/16 in. screws (C).

- A—Radio
- B—New Bracket
- C—Screw, Phillips, 7/16 in. (2 Used)

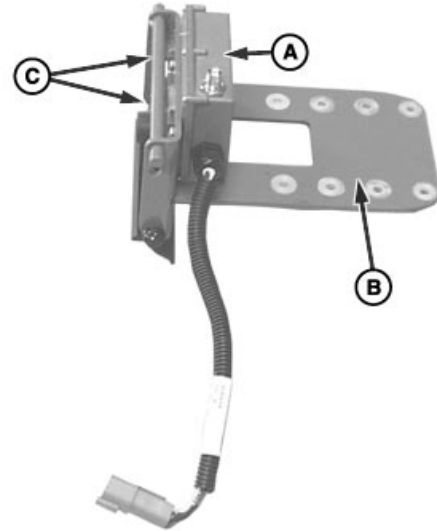

N64449 -UN-16DEC03

Continued on next page

OOU6050,0000501 -19-16DEC03-3/11

7. Connect RTK harness (A) to receiver (B).

A—RTK Harness
B—Receiver

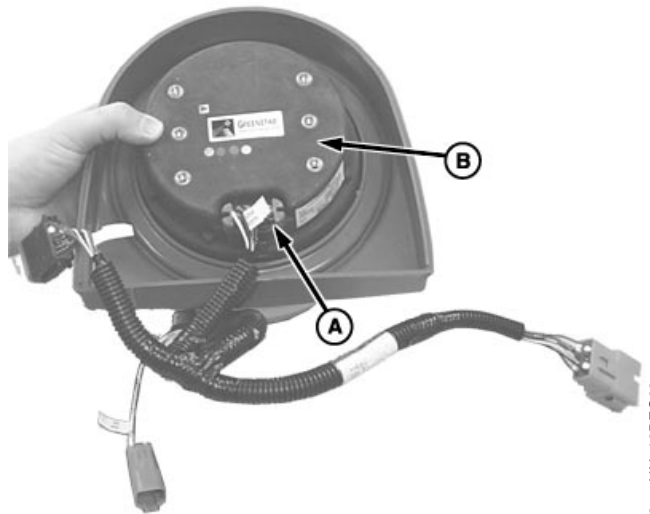

N64448 -UN-16DEC03

OOU6050,0000501 -19-16DEC03-4/11

8. Connect RTK harness (A) to radio harness (B).

A—RTK Harness
B—Radio Harness

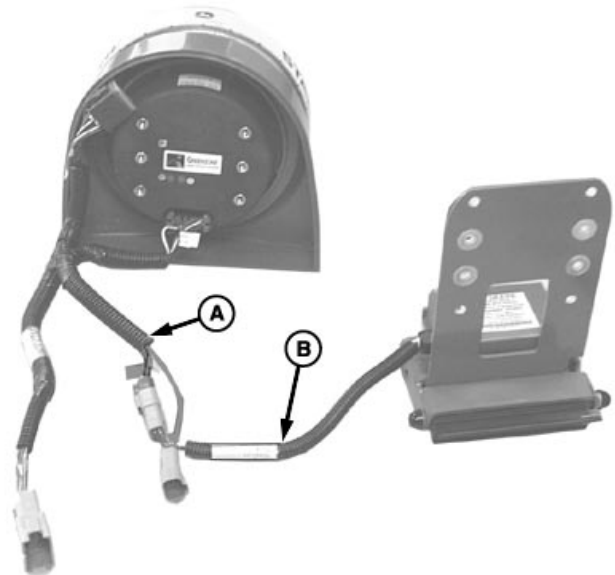

N64450 -UN-16DEC03

Continued on next page

OOU6050,0000501 -19-16DEC03-5/11

IMPORTANT: If base station does not have a TCM, a cap is required on TCM connector on harness or STARFIRE will not function.

NOTE: RTK Vehicles REQUIRE a TCM.

Base stations DO NOT REQUIRE a TCM.

9. **Receivers without TCM:** Connect RTK harness to TCM cap (A) and position section of harness in upper receiver shroud as shown.
10. Position radio harness (B) in upper receiver shroud as shown.
11. Position harness (C) as shown.
12. Attach receiver (D) and bracket (E) with screws (F).

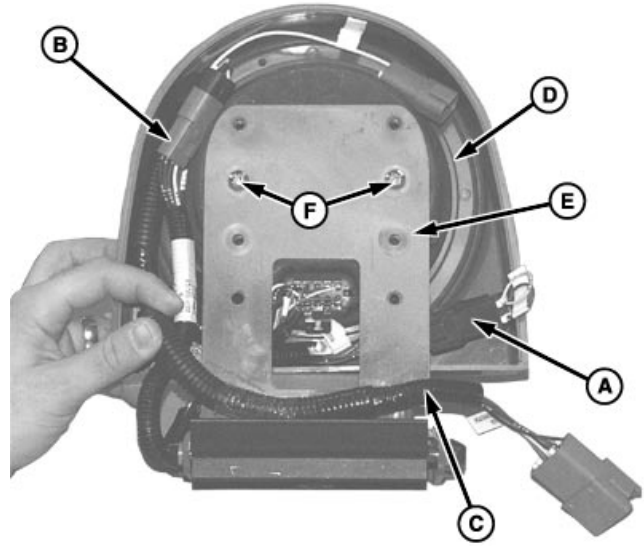

N64462 -UN-18DEC03

- A—TCM Cap
- B—Radio Harness
- C—Harness
- D—Receiver
- E—Bracket
- F—Screws (2 Used)

OUO6050,0000501 -19-16DEC03-6/11

13. **Receivers with TCM:** Connect RTK harness (A) to TCM (B).

- A—RTK Harness
- B—TCM

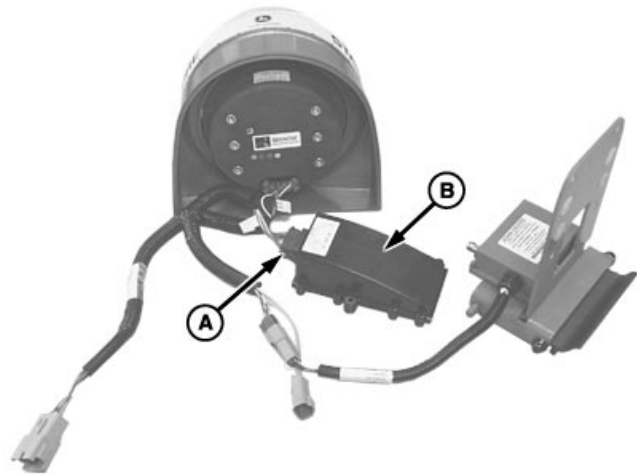

N64451 -UN-16DEC03

Continued on next page

OUO6050,0000501 -19-16DEC03-7/11

14. **Receivers with TCM:** Attach receiver (A), bracket (B), and TCM (C) with screws (D).

15. Route radio harness (E) in upper receiver shroud as shown.

16. Route harness (F) over bracket as shown.

- A—Receiver
- B—Bracket
- C—TCM
- D—Screw (2 Used)
- E—Radio Harness
- F—Harness

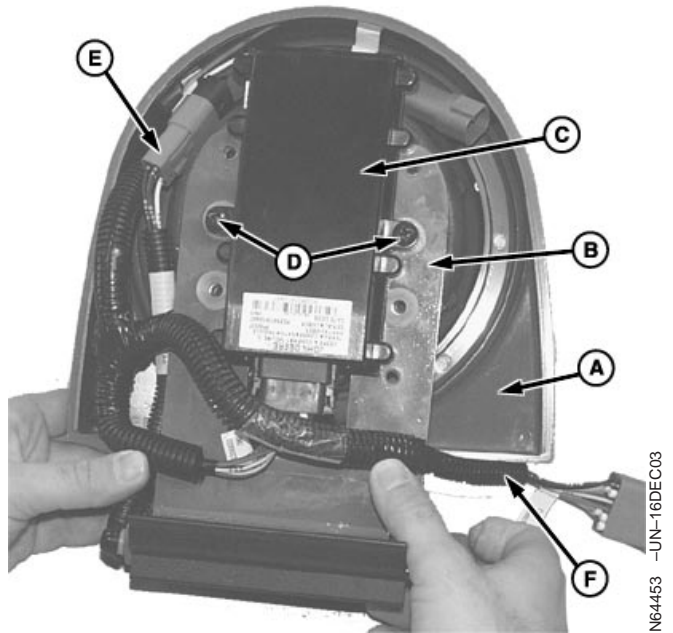

N64453 -UN-16DEC03

OOU6050,0000501 -19-16DEC03-8/11

IMPORTANT: System failure can occur if harness is pinched. Ensure harness is routed properly.

17. Position lower shroud (A) and upper shroud (B) together using care not to pinch any of the harnesses.

18. Harness connected to radio should have a drip loop (C) before going into receiver shroud.

19. Connector (D) is routed out of receiver on opposite side of bracket from harness connected to radio.

- A—Lower Shroud
- B—Upper Shroud
- C—Drip Loop
- D—Connector

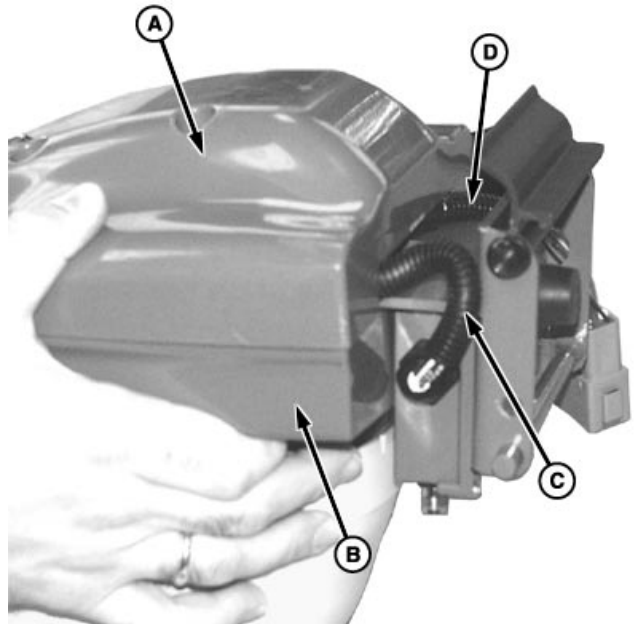

N64454 -UN-16DEC03

Continued on next page

OOU6050,0000501 -19-16DEC03-9/11

IMPORTANT: System failure can occur if harness is pinched. Ensure harness is routed properly prior to tightening hardware.

20. Attach shroud (A) with previously removed screws (B).

- A—Shroud
- B—Screws (Four Used)

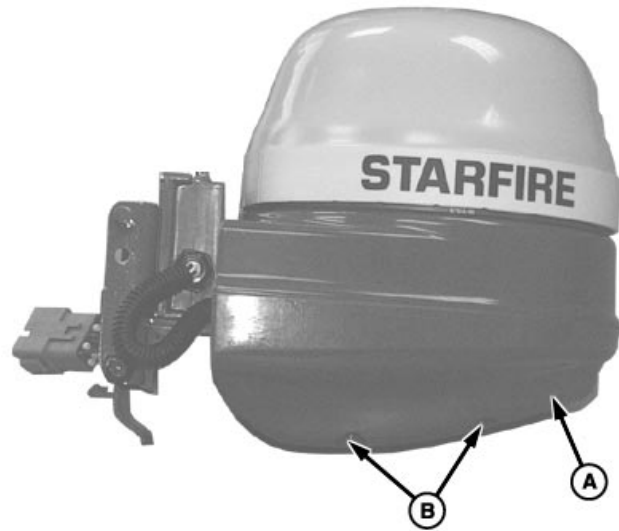

N64464 -UN-18DEC03

OUC6050,0000501 -19-16DEC03-10/11

21. Attach extension (A) and antenna (B) to radio (C).

- A—Extension
- B—Antenna
- C—Radio

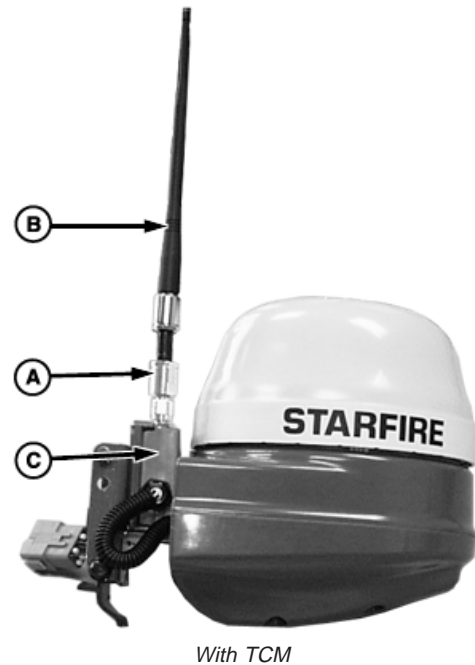

N64461 -UN-18DEC03

OUC6050,0000501 -19-16DEC03-11/11

Vehicle

1. Attach radio to receiver. (See RADIO INSTALLATION section.)
2. Attach bracket on receiver to bracket on vehicle.
3. Connect STARFIRE harness to GREENSTAR™ harness.
4. Calibrate TCM. See AutoTrac Operator's manual.



PC7866 -UN-26SEP03

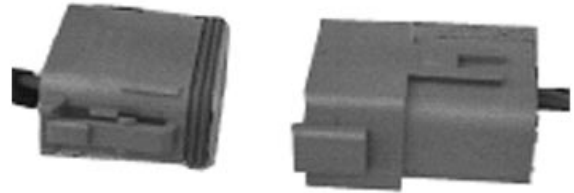

N64444 -UN-12DEC03

GREENSTAR is a trademark of Deere & Company

OUC6050,00004F6 -19-03DEC03-1/2

5. Enter RTK activation. See RTK Operator's manual.
6. Go to SETUP/STARFIRE/PAGE3.
 - Set RTK Operating Mode to VEHICLE.
 - Set RTK Network ID to match Base Station Network ID.
 - Set RTK Radio Channel to match Base Station Radio Channel.

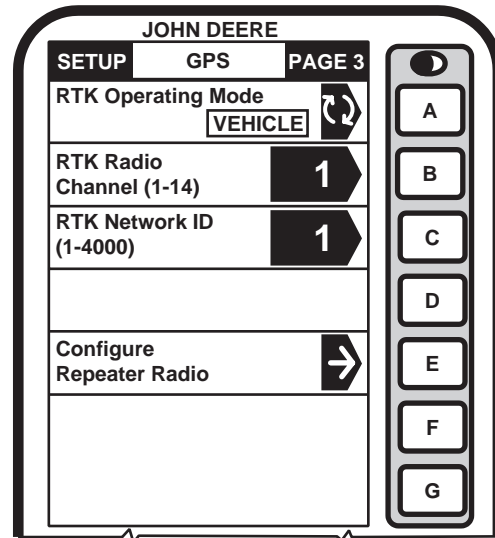

PC7883 -19-04NOV03

OUC6050,00004F6 -19-03DEC03-2/2

Absolute (24 Hour Survey) Base Station

⚠ CAUTION: Mounting location should be fixed firmly so movement of receiver is not possible. If base station receiver is allowed to move it will result in warnings and could result in vehicle movement. Mounting receiver on tall towers or grain legs, which can shift in wind, is not recommended. Radio and antenna assembly can be mounted in a higher location with optional harness (PF80652) to improve radio line of sight but receiver should be positioned so that it will not move. Mount a receiver close to a metal building can cause GPS interference. If GPS can not be acquired after installation change location or increase height of receiver.

1. Attach radio to receiver. (See RADIO INSTALLATION section.)
2. Attach universal bracket (A) to mounting location.
3. Attach receiver quick coupler (B) to universal mounting bracket.

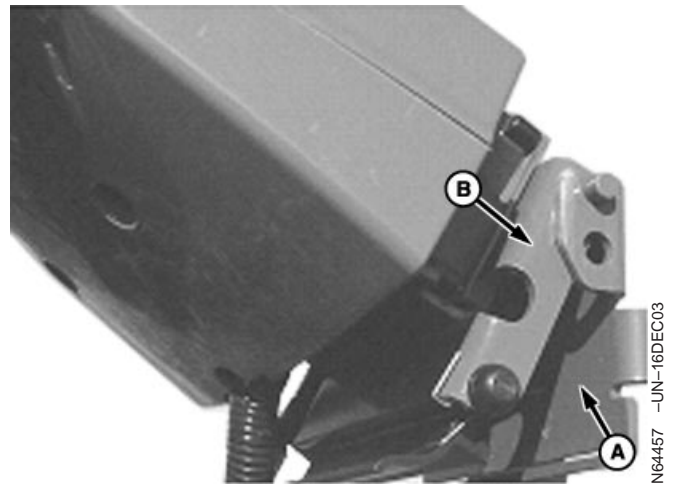

A—Universal Bracket
B—Receiver Quick Coupler

Continued on next page

OOU6050,00004FA -19-10DEC03-1/3



CAUTION: Always attach harness to power source before connecting STARFIRE receiver harness. Make sure power inverter has a minimum capacity of 3 amps. A smaller inverter could overheat or cause operational problems. If a battery is used, it is recommended to permanently attach eyelet terminals to 12V battery. Use of alligator type clips is not recommended as they can expose operators to sparks.

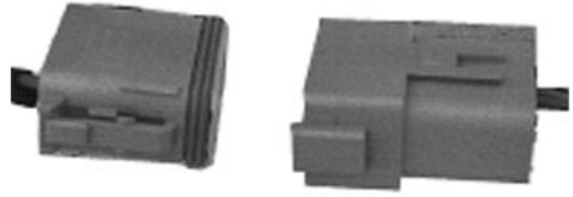

N64444 -UN-12DEC03

4. Connect receiver harness to power harness.
5. Connect power harness to power inverter or battery.
6. Use enclosed VELCRO™ straps to secure harness.
7. Attach GREENSTAR display to harness.
8. Power system.

VELCRO is a trademark of Velcro Industries B.V.

OUO6050,00004FA -19-10DEC03-2/3

9. Enter RTK activation. See RTK Operator's manual.
10. Go to SETUP/STARFIRE/PAGE3.
 - Set RTK Operating Mode to ABSOLUTE BASE.
 - Set RTK Network ID to match Vehicle Network ID.
 - Set RTK Radio Channel to match Vehicle Radio Channel.

IMPORTANT: Base station coordinates are stored in receiver. If receiver is changed these values can be entered into display for new receiver if operator does not want to perform another 24 hour survey.

11. Record base station location ID and coordinates.

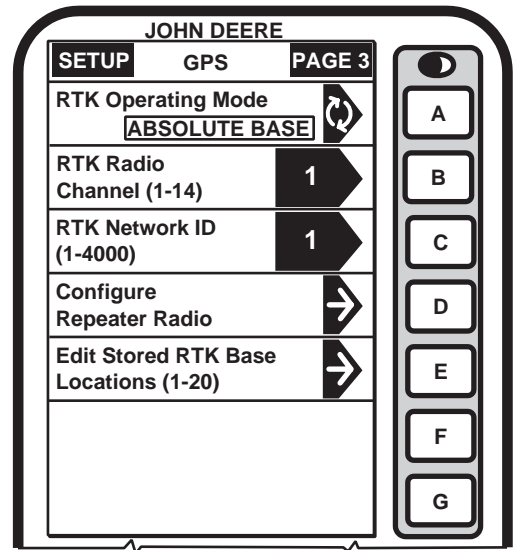

PC8022 -19-13NOV03

OUO6050,00004FA -19-10DEC03-3/3

Quick Survey Base Station



A—Tripod

N64460 -UN-16DEC03

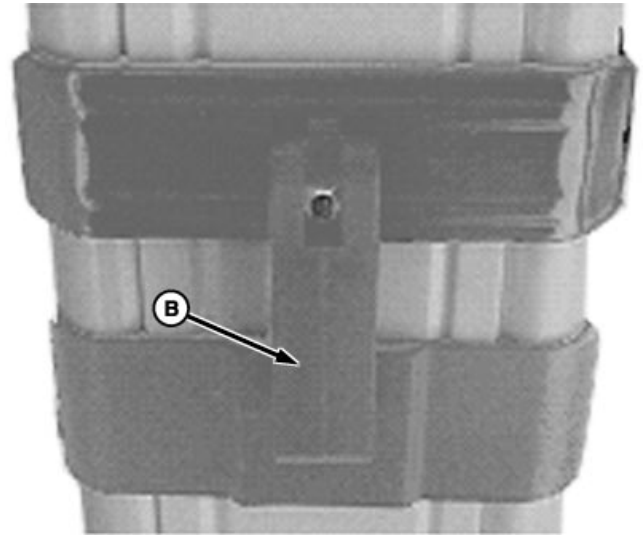

B—Latch

N64459 -UN-16DEC03



CAUTION: If tripod latches are loose, tighten hardware to ensure positive locking of tripod legs. Movement of tripod can cause unexpected vehicle motion.

1. Attach radio to receiver. (See RADIO INSTALLATION section.)

2. Position tripod (A) ensuring lever (B) is pushed down to fully lock each leg.

Continued on next page

OOU6050,00004FB -19-10DEC03-1/4

3. Attach bracket (A) to tripod (B).

A—Bracket
B—Tripod

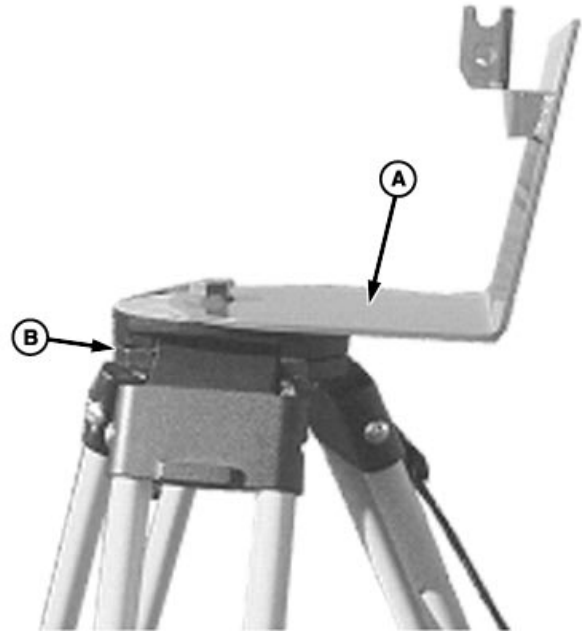

N64458 -UN-16DEC03

Continued on next page

OOU6050,00004FB -19-10DEC03-2/4

Repeater

1. Go to either RTK vehicle or base station.
2. Program Network ID and Radio channel as shown above.
3. Disconnect radio on vehicle (or base station).
4. Connect repeater radio.
5. Go to SETUP/STARFIRE/PAGE 3.
6. Press button next to "Configure Repeater Radio".
7. Wait for radio to configure.
8. Disconnect repeater radio.
9. Reconnect radio on vehicle (or base station).
10. Attach repeater to mounting location.
11. Connect repeater harness to repeater radio.
12. Connect to battery.
13. Use enclosed VELCRO straps to secure harness.

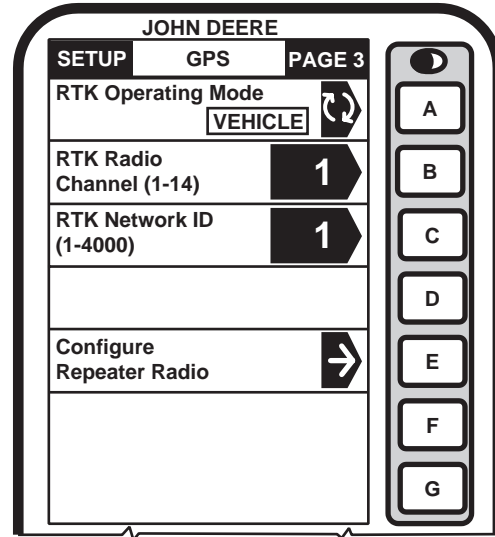

N64465 -UN-18DEC03

PC7983 -19-04NOV03

OUC6050,00004FC -19-10DEC03-1/1

