

GPSmile 53 Portable Automobile Navigation System

Product User Manual



Version: V1.00

April 2007

Registered info

HOLUX and GPSmile are trademarks of HOLUX Technology, Inc.

All other trademarks belong to each registered companies.

Note

- Contents of this manual will be modified without further notice.
- The proper operation temperature of the product is between 0°C~40°C. Operating or recharging in an environment with temperature over 45°C might cause system to stop functioning. yet this should be considered as a normal phenomenon. Please do not operate in an extreme temperature environment.



Declaration of Conformity

The following products is herewith confirmed to comply with the requirements set out in the Council Directive on the Approximation of the laws of the Member States relating to R&TTE Directive (1999/5/EC) that include the Electromagnetic Compatibility Directive (89/336/EEC) and Low Voltage Directive (73/23/EEC). The listed standard as below were applied:

The following Equipment:

Product : GPSmile53 Car Navigator
Trade name : **HOLUX**
Model Number : NAV-53A 、 NAV-53B

This product is herewith confirmed to comply with the requirements set out in the Council Directive on the Approximation of the laws of the Member States relating to R&TTE Directive (1999/5/EC) that include the Electromagnetic Compatibility Directive (89/336/EEC) and Low Voltage Directive (73/23/EEC), the following standards were applied:

1999/5/EC:

ETSI EN 300 328 :
ETSI EN 301 489-17 :
ETSI EN 301 489-1 :

73/23/EEC:

EN 60950-1 :

The following importer/manufacturer is responsible for this declaration:

Company Name : **HOLUX Technology, Inc**
Company Address : **1F, No.30, R&D Rd. II, Hsinchu City 300, Taiwan (R.O.C.)**
Telephone : **886-3-6687000** Facsimile : **886-3-6687111**

Person is responsible for marking this declaration:

Philip Yu
Name (Full Name)
October-24-2006
Date

Vice President
Position/ Title

Legal Signature

Safety Precautions

- Use the power adapter included with the package, using power adapters other than the one provided will result in malfunction and could prove dangerous.
- The device should only be used with the supplied batteries.
- About the power adapter
 1. Do not use the power adapter in a wet environment. When hands and feet are wet, do not touch the power adapter.
 2. While using the power adaptor ensure that the area is well ventilated. Do not let paper or other material cover the power adaptor, as this will interfere with cooling. Do not use the power adaptor whilst it is in a bag.
 3. Do not attempt to repair the device. If device is damaged or is in a wet environment, replace the device immediately.
- About the battery
 1. Use only the original factory approved charger.
 2. A Lithium battery is built in to the device. To prevent fire or skin burns, do not disassemble, pierce, impact, or expose the battery to fire. The battery will crack, explode, or release dangerous chemicals if placed in a fire.
- Important instructions
 1. Note: Replacing with an incorrect battery may result in an explosion. When disposing of the battery, follow the instructions. The replacement battery must be original factory approved.
 2. Regulations must be observed when recycling or disposing of batteries.
 3. The battery should only be used in this device.

Warranty Statement

- This warranty applies to parts and services of GPSmile53 manufactured and sold through Holux Technology Inc. The local area covered is Taiwan; the warrantee length is one year from date of purchase (counting from the date on the sales receipt). Under normal user operation, Holux Technology provides free repair services.
 - ❖ The replaced parts after repair are properties of Holux Technology Inc.
- Holux Technology is not responsible for providing repairs or replacements of any software; Holux Technology does not provide any warranty service for third party software/hardware.
- Important instructions

Note: This warranty does not cover damage or malfunction from the below causes: unauthorized disassembly/modification of unit, abuse or incorrect usage, accidental and other unpreventable causes, operation under variables mentioned other than in this product user manual, using parts not made or sold by Holux Technology, or repairs done by anyone other than Holux Technology and authorized retail/service provider.

- ❖ Expendable parts are not covered in the warranty.
- ❖ Any program, data, or portable storage media damages or loss are not responsible. Please contact your local Holux Technology authorized service provider to learn more about geographical limitations, proof of purchase requests, response time agreements, and other specific maintenance service requests.

Technical Support

- If there are any questions regarding the use of this product, please logon to the website www.holux.com and see the FAQ.
- If answers cannot be found on the website, please send us an e-mail at info@holux.com , stating your query and location.

Maintenance Service

HOLUX Technology, Inc.

+886-3-6687000

Web Site: www.holux.com

E-mail: info@holux.com

HOLUX Technology, Inc.

www.holux.com

Table of Contents

Warranty Statement	iv
Technical Support.....	v
Maintenance Service.....	v
Preface	1
Symbols	1
Important Notice	1
Other Functions	2
First time use.....	3
<i>Copyright</i>	3
<i>Important Notice</i>	3
Package Contents	4
Basic Operation	5
<i>Introduction</i>	5
Front View	5
Rear View	5
Left Side	6
Right Side	6
Top View	6
Getting Started	7
<i>SD memory card installation</i>	7
<i>Using the stylus</i>	8
<i>I/O interface</i>	8
<i>Charging</i>	9
Using Home / Travel adapter:	9
Using the car charger:	10
<i>Using the In Vehicle Bracket</i>	12

Operating Methods	14
<i>Startup</i>	<i>14</i>
<i>Shutdown.....</i>	<i>14</i>
Using Functions	15
<i>Function Menu Music Playback Function.....</i>	<i>16</i>
<i>Storing MP3 files onto SD memory cards.....</i>	<i>16</i>
<i>Starting music playback.....</i>	<i>16</i>
<i>Image Browsing Function.....</i>	<i>18</i>
Other	19
<i>Video (Optional).....</i>	<i>19</i>
<i>eBook.....</i>	<i>22</i>
<i>Setting.....</i>	<i>24</i>
Time.....	24
Volume	25
Startup Message.....	26
Stylus Adjustment.....	27
Backlight Setting	28
Version	29
About.....	30
Using the CD	31
Troubleshooting.....	31
<i>System reset.....</i>	<i>31</i>
<i>Quick Troubleshooting.....</i>	<i>32</i>
<i>Normal Care and Maintenance.....</i>	<i>32</i>
Keep dry.....	32
Do not drop the unit	32
Avoid sudden temperature changes	32
Keep away from strong magnetic fields	33
Operating temperature.....	33
Avoid exposure to sunlight.....	33

Using the stylus	33
Cleaning the screen.....	33
Do not disassemble.....	33
<i>Storage</i>	33
Appendix	34
<i>Specifications</i>	34
Federal regulations	35

Preface

We appreciate your purchase of the GPSmile 53.

Please read all instructions thoroughly for a full understanding of the products' features.

Symbols

For fast reference to the data you wish to find, this manual uses the following symbols.

- ✓ This icon means to take note to messages and to read for while during use.
- ☠ This icon means a warning and should take care not to damage the unit.
- ☞ This icon means useful tips for extra information while using.

Important Notice

- This system only provides a navigational reference. Do not use this system for any directional, distance, and geographic etc precise measurements.
- The first GPS positioning should be performed at a single set point, wide-open area without building shelters. Positioning time length will depend on the satellite signal strength, cloud levels; possibly taking up to 10 minutes.
- GPS (Global Positioning System) is the satellite system used by the United States of America Department of Defense. All maintenance and operations are also managed by the United States of America Department of Defense. Should the system be modified and adjusted, the precision and operation of GPS related systems might be affected.
- Any wireless communication products (mobile phone, radio, speed detection unit etc) might affect the GPS signal, resulting in a poor signal.
- For safety reasons, do not operate this system while driving a vehicle.

- Do not leave this unit under your front windshield after you leave the vehicle. Exposure to high temperatures might be dangerous and cause overheating to the battery, resulting in malfunction of the device.
- Window tinting might interfere with the reception of satellite signals. We recommend you install a vehicle antenna to strengthen and stabilize the signal.
- The planned navigational route is for reference only; changes in roadside conditions (one way streets, no right turns) may happen so please respond accordingly to the situation and decide whether or not to follow the planned course.
- When placing this system in the vehicle, please secure with brackets on the car to ensure safety. The recommended installation location is illustrated below.

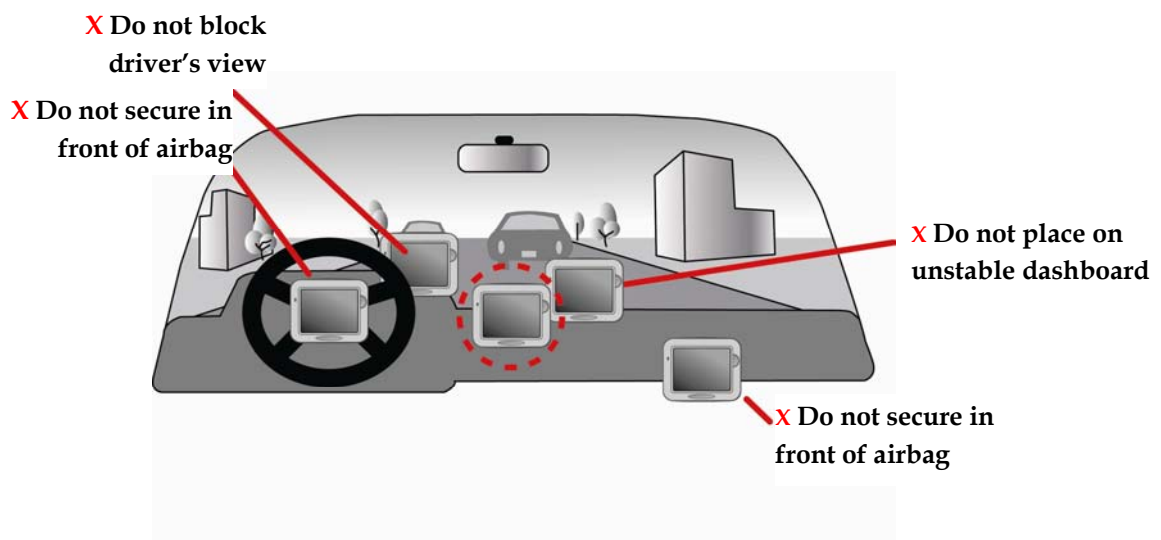

- Differences between manufactured and shipped versions may be present; this software may be updated frequently. If the descriptions in this manual are different from your software version, please follow the software version currently on hand.

Other Functions

- Music playback: plays MP3 music files.
- Image display: displays photographs or image files
- Video play films
- eBook display text file

First time use

Copyright

Without the written consent of HOLUX Technology, Inc, this manual including the product and the software may not be duplicated, transmitted, recorded or saved on storage devices; nor shall it be translated under any circumstances into any other languages.

Copyright ©2006 HOLUX Technology, Inc. All rights reserved.

Important Notice

Please read thoroughly this manual of operating instructions and explanations. Use only original factory approved batteries and accessories to prevent unexpected damage. If the correct procedures were not followed for operation or incompatible accessories were connected, this violates the warrantee agreement and will automatically void the warrantee; even causing personal safety issues.

Package Contents

Your product should include the following accessories:



NAV-53 Unit



In Vehicle Bracket



Bracket fixing



Car Adapter



Home / Travel Adapter
(Optional)



SD Memory Card
(Optional)



CD-ROM

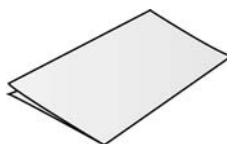

Quick Guide

Basic Operation

Introduction

Front View



Rear View



Left Side

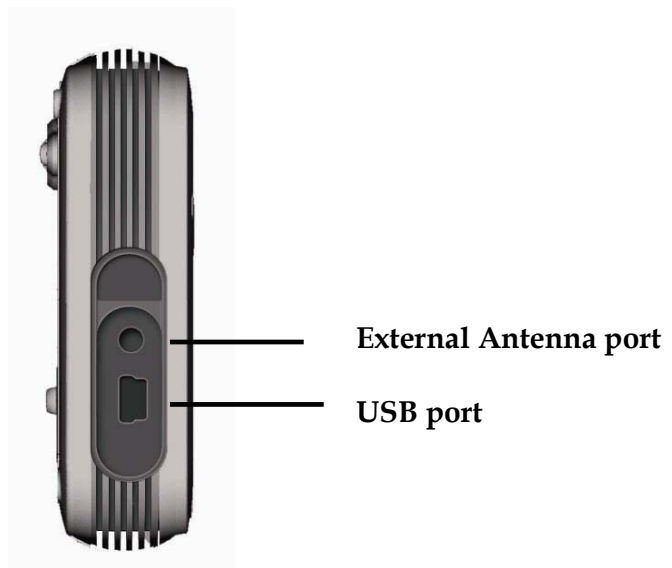

Right Side

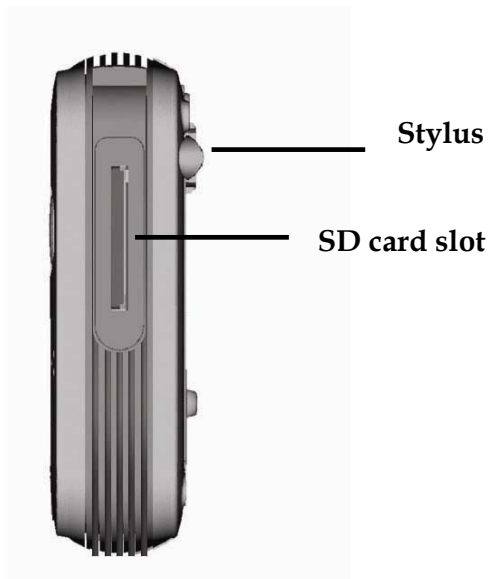

Top View



Getting Started

If you are a first-time system user, the following explanations will help you quickly understand the system operations, and experience the system's powerful and convenient functions.

SD memory card installation

This unit is equipped with a SD memory card slot; you can purchase SD (Secure Digital) Cards to expand the memory capacity.

To insert the memory card:

With the metal contacts of the memory card facing back, insert the card into the slot on the right side of the unit.

To remove the memory card:

1. Gently press the top of the memory card, and the card will eject automatically.
2. Then pull to remove the memory card.



- ✓ The included memory card contains the digital map files that are required for the GPS navigational data. Please do not delete.
- ✓ When removing the memory card, please make sure the card is not reading data, or it will cause a system crash.
- ✓ Do not set the SD memory card as write protected, or the system will not operate properly.
- ⚠ When operating, accidental removal of the memory card will result in showing an error message. Please reinsert the memory card and the system may need to be reset before further use.

Using the stylus

This unit can be controlled easily through the touch screen. The stylus is an assist tool for operating this unit and is concealed in a pen slot at the rear. Pull out to use.

Stylus



I/O interface

The I/O interface has five pins, and each pin function is described as below.



Pin	Function
1	VCCIN (DC 5.4 ± 0.2 1A)
2	TX Serial Data output port A (TTL Level ; $V_{oh} \geq 2.4V$, $V_{ol} \leq 0.4V$; $I_{oh} = I_{ol} = 2mA$)
3	RX Serial Data input port A (TTL Level ; $V_{ih} \geq 0.7 * VCC$; $V_{il} \leq 0.3 * VCC$)
4	GND
5	Outside device (Reserve of software program definition.)

Charging

Using Home / Travel adapter:

Before using the device for the first time, we strongly suggest you use a fully charged battery.

1. Insert the USB connector into the unit.
2. Plug the adapter into a power outlet.



Using the car charger:

While using the device in a vehicle, use the included car charger for long periods of usage.

1. Plug in the small plug into the power jack on the rear of the in vehicle bracket.
2. Insert the other end into the cigarette lighter.

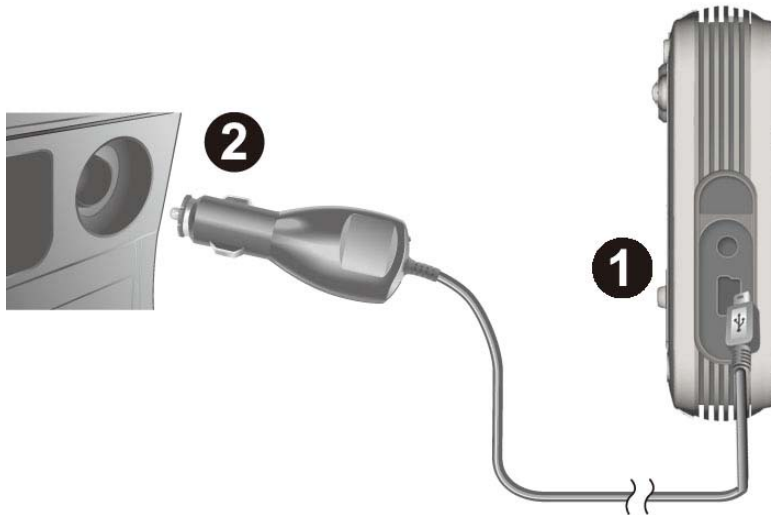

- ✓ This device uses a built-in rechargeable battery, please note the following:
- Please do not charge in a hot environment, such as on a balcony or expose to direct sunlight.
 - Do not wait until the battery is depleted to recharge.
 - When not using the unit for a long time, please turn off the system switch.
 - When charging a completely depleted battery, wait at least one minute before system startup. This will prevent excessive battery discharge.
 - When charging starts, the charging indicator light will be red, please wait for the charging to complete (this might take several hours). After charging is completed the indicator light will be green.

Charging indicator
LED



Using the In Vehicle Bracket

The included in vehicle bracket set can be securely suctioned on the front windshield, or using the adhesive plate, securing on top of the glove compartment. This device will effectively secure the GPS unit in the vehicle. Follow the procedures below to secure the bracket:

1. Follow the arrows and stable the unit into the in-vehicle bracket fitting holes to secure.
2. Gently push in the unit until the unit is tightly fixed with the bracket.



Note: Please note the directions of the arrows, when fitted the assembly should be tight. If these directions are not followed, a loose fit will result, and components must be reassembled.

3. Bend the bracket support to a proper angle. Suction the vehicle bracket securely to the windshield, ensuring its base is resting firmly on the dashboard.

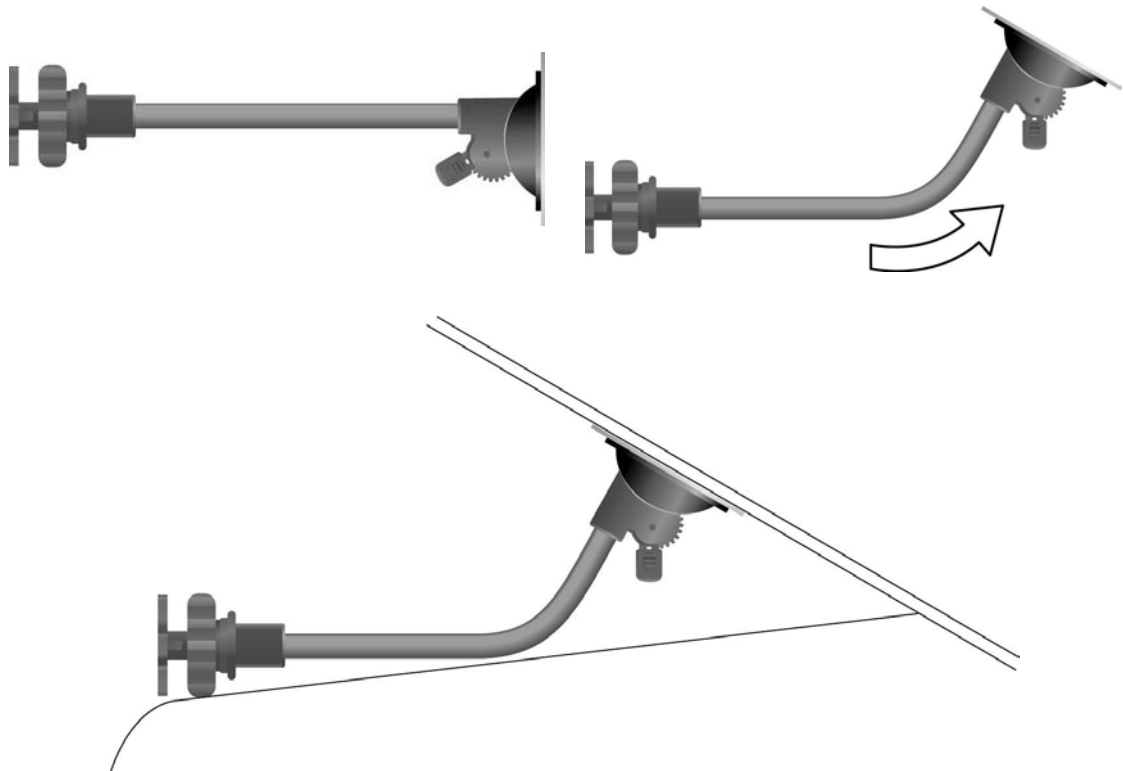

4. Follow the directions to insert the bracket into the slots on the bracket, and slide to fix the set (A → B).

5. The in vehicle bracket assembly is complete.

- ✓ When using the in-vehicle secure bracket, do not install in a location that will block the view of the driver

- ✓ Recommended installation requirements:

The bracket base should be resting securely on the dashboard to prevent excessive shock.



Operating Methods

Startup

1. For first time use, please turn the system power switch at the rear side **On**.
2. Press and hold the power button for about two seconds to turn on the power.

Note: Before the first time use, please switch the system power on.

Shutdown

1. While power is on, press the power button to turn off power.
2. If the unit will not be used for a long time, turn the system power switch at the rear side **Off**.



System power switch



Using Functions

During the first startup, the screen will show the main screen consisting of four functions: navigation, music, photo, and settings. Directly select the icon onscreen to use the function.



GPS

Loads the navigation program and navigation screen

Note: If the SD card with navigator software is inserted, the system will enter GPS function automatically after startup.

Music

Plays MP3 music

Photo

Plays images

Other

Enter expansive functions (Video, eBook) and system setup

Function Menu

Music Playback Function

This unit has an MP3 Music Playback function that is capable of playing back MP3 files stored on SD memory cards.

Storing MP3 files onto SD memory cards

On your computer, you must first convert the music from an audio CD into MP3 files, then save them onto the SD memory card.

All the files need to be stored under the **MP3** directory, and the file format needs to be ***.mp3**.

Starting music playback

1. Insert the SD memory card with stored MP3 files into the SD memory card slot on the unit.
2. Power on, and select the **[Music]** icon on the main menu.



3. The Music Playback Window. Use the buttons to control each playback function.



- | | | | |
|---|-------------------|----|-----------------------|
| 1 | Play / Pause | 8 | Progress bar |
| 2 | Stop | 9 | Timer |
| 3 | Previous | 10 | Music Status |
| 4 | Repeat mode | 11 | Repeat mode indicator |
| 5 | Next | 12 | Volume display |
| 6 | Battery indicator | 13 | Time |
| 7 | Exit | | |

Image Browsing Function

1. The system has an Image Browsing function that is capable of displaying images/photographs stored on SD memory cards.

All the files need to be stored under the **Image** directory, and the file format needs to be “*.jpg”.



2. Insert the SD memory card with stored image files into the SD memory card slot on the unit.
3. Power on, and select [Photo] icon on Main Menu.
4. The Image Browsing Window.

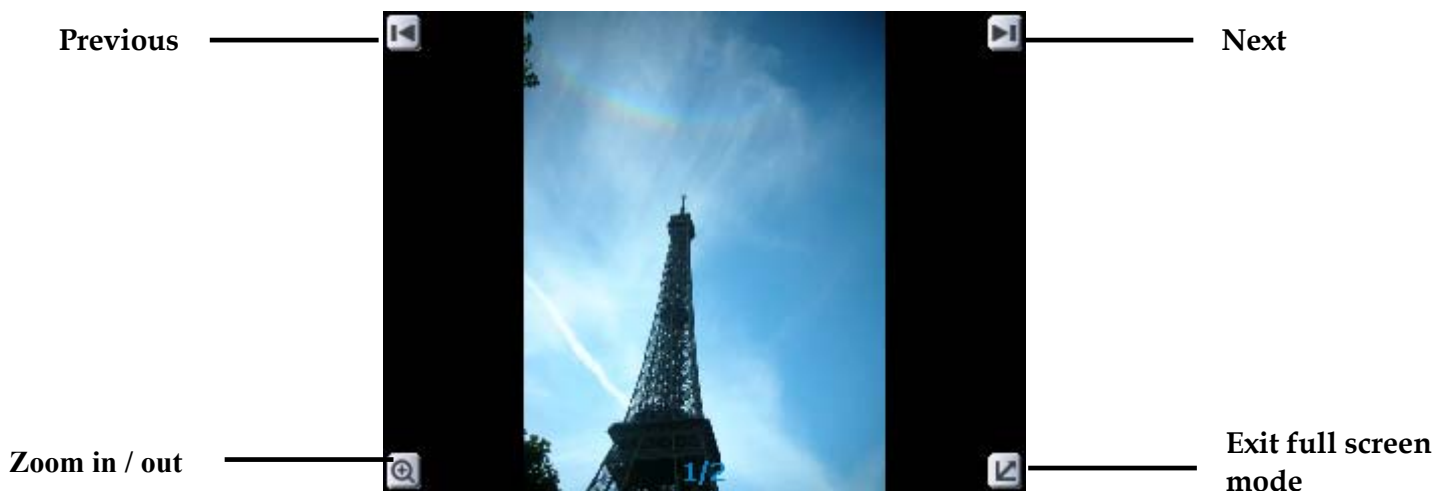
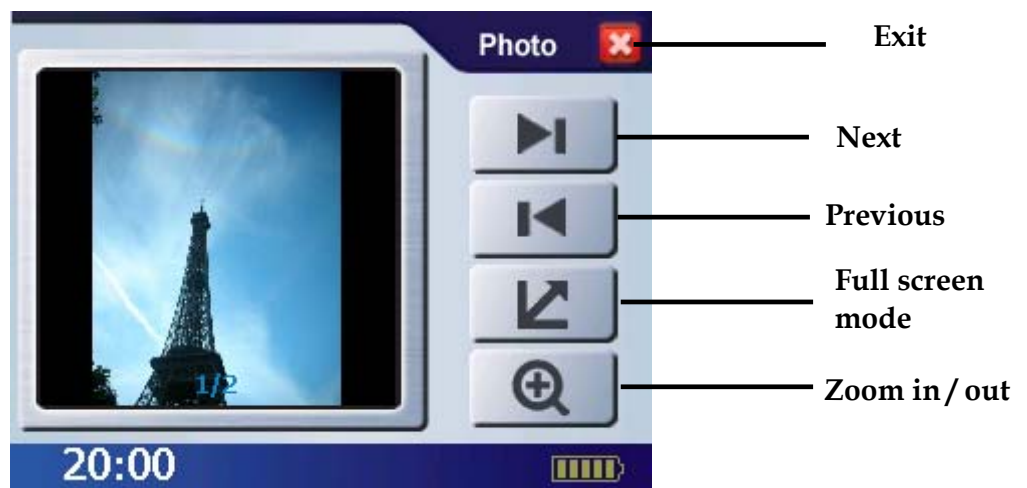

Other

The other function gives you the ability to adjust the basic system options, including time settings, volume control, screen calibration, startup message, backlight setting, version info, and GPS reset etc. You can modify the settings according to personal preferences.

Video (Optional)

Video can read the film with the following data format: __.wmv, __.asf. Please convert file into readable format and save them onto the SD memory card in a folder named "film".

1. Insert the SD memory card with Video files into the SD memory card slot on the unit.
2. Power on, and at the Main Menu Screen, select the [Other] icon.



3. On the sub menu, select [Video] icon to enter.

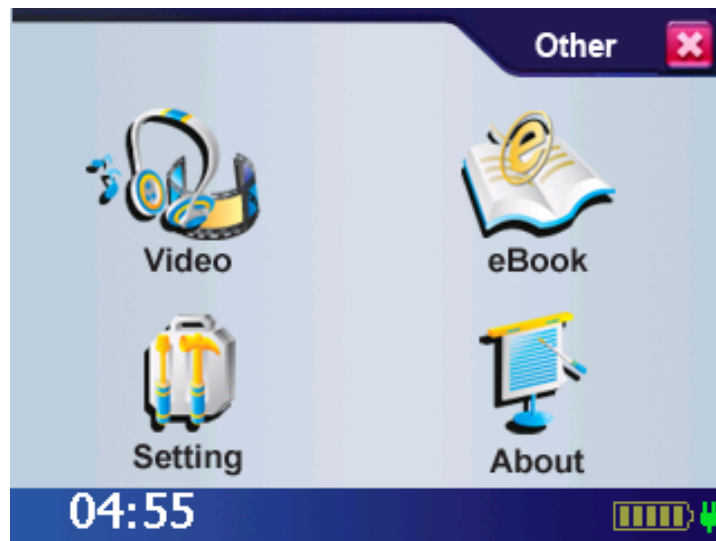

4. Use the arrow key right/left to forward/backward the film.



- | | | | |
|---|--------------------------|----|--------------|
| 1 | Video Title | 8 | Play / Pause |
| 2 | Video status | 9 | Stop |
| 3 | Screen | 10 | Forward |
| 4 | Volume | 11 | Next |
| 5 | Time | 12 | Full Screen |
| 6 | Exit | 13 | Previous |
| 7 | Timer / Total Video Time | 14 | Battery |

Full Screen Mode



Double click at anywhere on the screen to exit full screen mode

5. Press "X" to exit the film viewer.

eBook

eBook can only read file with __.txt format, please save them onto the SD memory card in a folder named "ebook".

1. Insert the SD memory card with ebook files into the SD memory card slot on the unit.
2. Power on, and at the Main Menu Screen, select the [Other] icon.



3. On the sub menu, select [eBook] icon to enter.

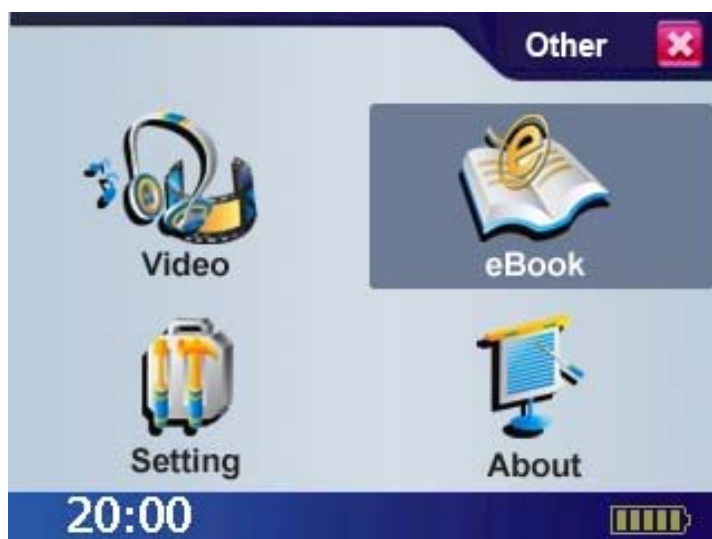

4. Use the arrow key up and down to change between books.

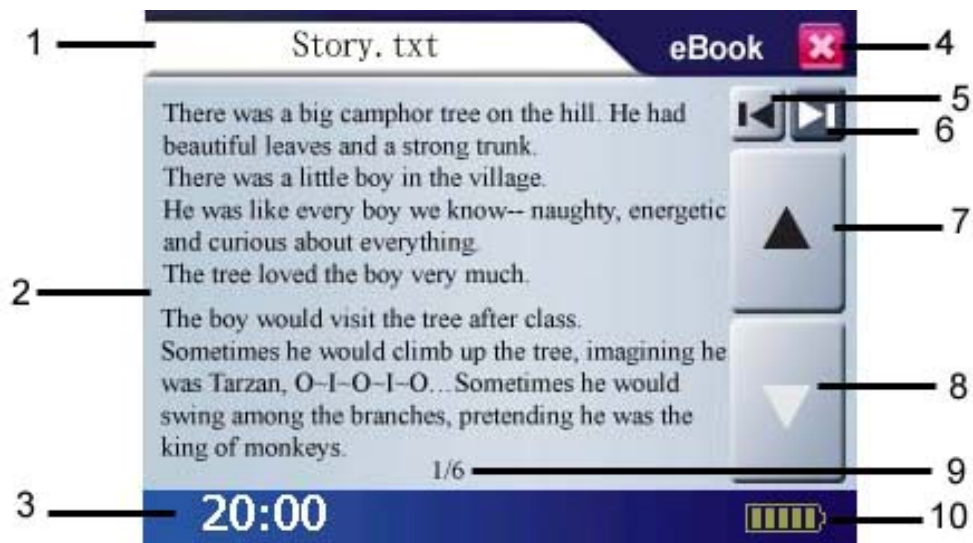

- | | | | |
|----------|-------------|-----------|-------------|
| 1 | eBook Title | 6 | Next |
| 2 | Screen | 7 | Page up |
| 3 | Time | 8 | Page down |
| 4 | Exit | 9 | Page Status |
| 5 | Previous | 10 | Battery |

5. Press "X" to exit the eBook reader.

Setting

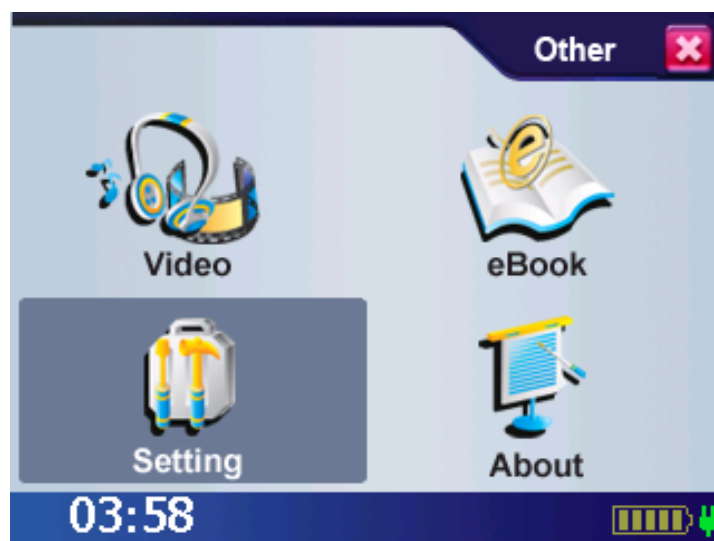

Time

1. After system startup, select **[Other]** from the main screen to go into the System Settings window.



2. Select from the **Hour** pull down menu and choose the correct value.
3. Select from the **Minute** pull down menu and choose the correct value.



4. Select  to confirm, or select  to keep original settings.
5. Select  to return to main menu screen.

Volume

1. Under the settings window, control the volume directly with the **scroll bar**. There are six levels of volume in total.



Startup Message

1. Under the settings window, check on the **Warning Voice** to / (check / uncheck) for whether the startup message is to be broadcast.



Stylus Adjustment

Control of the unit is accomplished primarily through the stylus by touching/writing on the screen. If the system cannot correctly identify your stylus' input, please run through the screen calibration procedure.

1. From the settings window, select [Stylus Adjustment] to start the screen calibration procedure.



2. Use the stylus and touch the cross at the center of the screen once.
3. Touch the cross in the second position once.
4. Touch the cross in the third position once.
5. Continue the calibration by touching the cross.

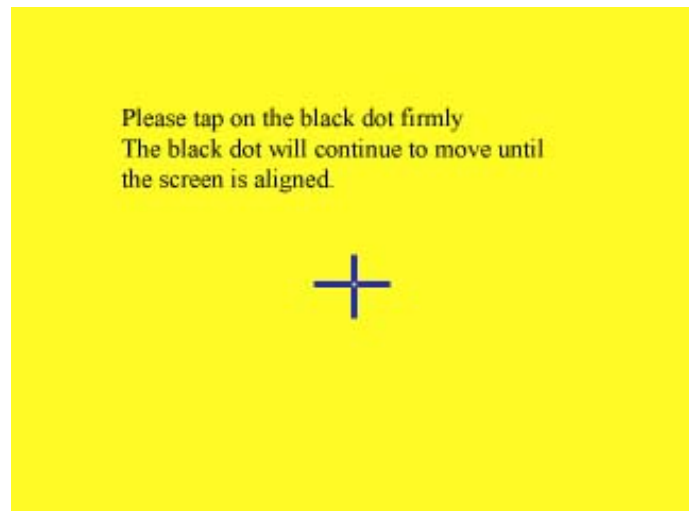

6. setting page will return when stylus adjustment is finished.

Backlight Setting

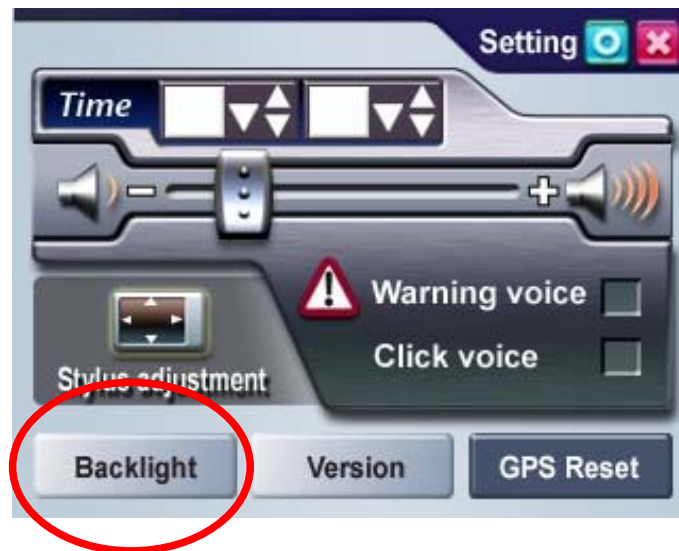

The backlight setting will adjust the brightness of the backlight and the auto-off time.

1. Under the setting window, select **Backlight** to enter the backlight setting window.



2. Select the time to turn off backlight when running off the battery / external power (1 min, 3 min, 5 min, 10 min, 30 min, Always).



3. Scroll the brightness bar to control backlight brightness. There are six levels in total.
4. Select  to confirm or select  to keep the original settings.
5. Select  to return to main menu screen.

Version

1. Under the setting window, select **Version** to enter the version window.
2. The screen display will show the version information.



3. Select  to exit the Version screen.

About

1. Under the Other window, select **About** to enter the about page.
2. The screen display will show instructions for all function.

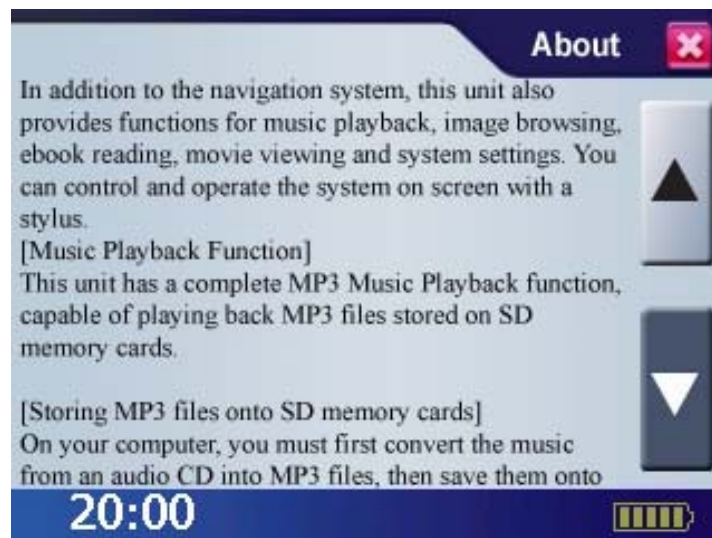

3. Select  to exit the Version screen.

Using the CD

Troubleshooting

System reset

Only under extremely few circumstances will it be required to reboot the system. Reset your system if the following situations occur:

1. Heavy lag experienced with screen refresh or operations, resulting in an inoperable system.
2. Cannot turn off the system with power button.
3. No response with selection on the screen.
 - Switch the system power to be off and switch it back on.



System Power switch

- The system will immediately reset.
- You will now see the main screen and the system is ready for use.



Quick Troubleshooting

Power	Cannot startup	Insufficient battery charge, please connect to the adapter and restart system.
Screen	No screen displayed	After powering up, if the system does not respond, try the following: 1. Connect adapter, restart system. 2. Reset system.
	Display speed is too slow	1. Check if the battery is low on power. 2. Reset system.
	Screen has no response	Reset system.
Navigation	GPS cannot display my current location	Make sure your current location is not obstructed by buildings or other interferences.

Normal Care and Maintenance

To ensure the unit's normal operation and extended life span, please note the following while using and storing:

Keep dry

This product is not waterproof. If it comes into contact with water spray or is submerged it will seriously damage the components, resulting in irreversible damage.

Do not drop the unit

If violently impacted or shocked, serious damage may be caused.

Avoid sudden temperature changes

Condensation may occur when entering a warm room on a cold day. To prevent condensation from damaging the unit, please place into an airtight plastic bag before sudden temperature changes.

Keep away from strong magnetic fields

When using or storing, please keep away from strong electromagnetic/radioactive or magnetic field equipment.

Operating temperature

The products operating temperature is between 0°C ~ 40°C; please do not operate under extreme temperatures.

Avoid exposure to sunlight

Please avoid long periods of sunlight or high temperature exposure.

Using the stylus

The LCD screen is easily scratched; please use only the stylus for operation. Do not use any other sharp objects on the screen to avoid damaging the LCD screen.

Cleaning the screen

Using a soft clean cloth to wipe the screen is recommended; do not use ordinary tissue to wipe the screen.

Do not disassemble

Please do not disassemble the product, this may void the warranty and damage the unit.

Storage

For storage, keeping the unit in a dry box is recommended.

Please do not keep the product in the following environments:

1. Unventilated and humid locations.
2. In a car window that is exposed to excessive amounts of sunlight.
3. In an environment where humidity is over 90%.

Appendix

Specifications

Integrated GPS Receiver	32 parallel channels
Acquisition Time	<ul style="list-style-type: none"> • Reacquisition : 0.1 sec. (AVG) • Hot start : 1 sec. (AVG) • Warm start : 33 sec. (AVG) • Cold start : 36 sec. (AVG)
Accuracy	Position: 3.0 m CEP without SA* Velocity: 0.1 m/s
GPS antenna	Built-in patch antenna
Handheld Software (Pre-loaded)	Companion CD:NAV-53 Handheld Manual
Processor	Samsung S3C2440A 400 MHz.
Operating System	Microsoft Windows CE 5.0 Core Version
Memory	32 MB NAND flash memory and 64MB SDRAM memory
Weight	≲ 170 g
Size	99 (L)x85 (W)x27 (H) mm
Car Holder / Charger	Input voltage: 11V. ~ 28V. Output voltage: 5.5V. ± 0.3V.
Battery	Rechargeable 1150mAh. Battery life: 2 ~ 4 hrs.
Extension Slot	SD / MMC
Display	3.5" high-brightness & contrast ratio transfective TFT LCD (16.7 M colors) with touch screen. 320 x 240 resolution
LED	Orange/Green LED for battery charging status
Audio	Built-in speaker. Software volume control.
Operation Temperature	-10°C ~ 60°C
Storage Temperature	-20°C ~ 70°C
Mini-USB Connector	USB client; DC power in
Optional Function	Bluetooth / Waterproof / TMC

* Cit. MTK original chipset spec.

Federal regulations

This device complies with Part 15 of the FCC Rules. Operation is subject to the following two conditions: (1) this device may not cause harmful interference, and (2) this device must accept any interference received, including interference that may cause undesired operation.

FEDERAL COMMUNICATIONS COMMISSION INTERFERENCE STATEMENT

This equipment has been tested and found to comply with the limits for a Class B digital device, pursuant to part 15 of the FCC Rules. These limits are designed to provide reasonable protection against harmful interference in a residential installation. This equipment generates, uses and can radiate radio frequency energy and, if not installed and used in accordance with the instructions, may cause harmful interference to radio communications. However, there is no guarantee that interference will not occur in a particular installation. If this equipment does cause harmful interference to radio or television reception, which can be determined by turning the equipment off and on, the user is encouraged to try to correct the interference by one or more of the following measures:

- Reorient or relocate the receiving antenna.
- Increase the separation between the equipment and receiver.
- Connect the equipment into an outlet on a circuit different from that to which the receiver is connected.
- Consult the dealer or an experienced radio/ TV technician for help.

CAUTION:

Any changes or modifications not expressly approved by the grantee of this device could void the user's authority to operate the equipment.

This equipment is in compliance with the essential requirements and other relevant provisions of directive 1999/5/EC.

RF exposure warning

This equipment must be installed and operated in accordance with provided instructions and the antenna(s) used for this transmitter must be installed to provide a separation distance of at least 20 cm from all persons and must not be co-located or operating in conjunction with any other antenna or transmitter. End-users and installers must be provide with antenna installation instructions and transmitter operating conditions for satisfying RF exposure compliance.