



OWNER'S MANUAL
AND REFERENCE

GPSMAP 135 Sounder™



Software Version 2.30 or above, Internal Database Version 2.01 © Navionics Corporation

G-chart™ cartridge data is copyrighted by Navionics Corporation and GARMIN Corporation and may not be copied or used for any other purpose without permission.

© 1997 GARMIN Corporation
1200 E. 151st Street, Olathe, KS USA 66062
Tel: 913-397-8200 or 800-800-1020
Fax: 913-397-8282
Web Site Address: www.garmin.com

GARMIN (Europe) LTD
Unit 5, The Quadrangle, Abbey Park Industrial Estate, Romsey, UK SO51 9AQ,
Tel: 011-44-1794-519944
Fax: 011-44-1794-519222

All rights reserved. No part of this manual may be reproduced or transmitted in any form or by any means, electronic or manual, including photocopying and recording, for any purpose without the express written permission of GARMIN.

Information in this document is subject to change without notice. GARMIN reserves the right to change or improve its products and to make changes in the content without obligation to notify any person or organization of such changes or improvements.



INTRODUCTION Warning

Warning

The GPSMAP 135 Sounder should not be used as a navigational aid or depth sounder to prevent collision, grounding, boat damage, or personal injury. The digital depth displayed is the depth under the back of your boat and not the front. By the time a depth is displayed most of your boat has already passed over that area. We recommend that you operate the boat at very slow speed if you suspect shallow water or submerged objects.

GARMIN, GPSMAP, G-chart, AutoLocate, TracBack and PhaseTrac12 are trademarks of GARMIN Corporation and may only be used with permission. All rights are reserved.



INTRODUCTION

Cautions

CAUTION!

The GARMIN GPSMAP 135 Sounder has no user-serviceable parts. Should you ever encounter a problem with your unit, please take it to an authorized GARMIN dealer for repairs.

The GPSMAP 135 Sounder is screwed shut and dry nitrogen sealed. Any attempt to open the case to change or modify the unit in any way will void your warranty and may result in permanent damage to the equipment.

Caution

The GPS system is operated by the United States government, which is solely responsible for its accuracy and maintenance. The system is subject to changes which could affect the accuracy and performance of all GPS equipment. Although the GARMIN GPSMAP 135 Sounder is a precision electronic NAVigation AID (NAVAID), any NAVAID can be misused or misinterpreted and, therefore, become unsafe.

Use the GPSMAP 135 Sounder at your own risk. To reduce the risk of unsafe operation, carefully review and understand all aspects of this Owner's Manual—and thoroughly practice operation using the simulator mode prior to actual use. When in actual use, carefully compare indications from the GPSMAP 135 Sounder to all available navigation sources, including the information from other NAVAIDs, visual sightings, charts, etc. For safety, always resolve any discrepancies before continuing navigation.

NOTE: This equipment generates, uses and can radiate radio frequency energy and, if not installed and used in accordance with the instructions, may cause harmful interference to radio communications. There is no guarantee that interference will not occur in a particular installation. If this equipment does cause harmful interference, the user is encouraged to try to correct the interference by relocating the equipment or connecting the equipment to a different circuit. Consult an authorized dealer or other qualified technician for additional help if these remedies do not correct the problem.

This device complies with Part 15 of the FCC limits for class B digital devices for home or office use. Operation is subject to the following conditions: (1) This device may not cause harmful interference, and (2) this device must accept any interference received, including interference that may cause undesired operation.



INTRODUCTION

Capabilities

Designed for detailed electronic charting and complete depth sounding capability, the GARMIN GPSMAP 135 Sounder is a powerful navigation device that can also give you the fishfinding information you need in fresh or saltwater:

Precision Performance

- High-contrast, four-level gray, LCD screen
- PhaseTrac12 receiver tracks and uses up to 12 satellites simultaneously for fast, accurate positioning
- Differential-Ready— just add the optional GBR 21 beacon receiver for better than 5-meter accuracy
- Dry nitrogen-sealed case for use in exposed locations

Advanced Navigating and Plotting

- 250 alphanumeric waypoints with selectable icons and comments
- Built-in worldwide database usable from 4096 to 64 nm scales
- 20 reversible routes with up to 30 waypoints each
- G-chart™ electronic charting with inland and offshore coverage
- TracBack™ route feature which allows you to quickly retrace your track log to a starting position
- Built-in simulator mode

Superior Fishfinding Ability

- Four zoom levels with a moving view window
- Underwater waypoint marking
- Map/Sounder split screen combines navigation and fishfinding information
- Fish and depth alarms
- Continuously shown digital depth display on all pages



INTRODUCTION

Warranty

WARRANTY

GARMIN warrants this product to be free from defects in materials and workmanship for one year from the date of purchase. GARMIN will, at its sole option, repair or replace any components which fail in normal use. Such repairs or replacement will be made at no charge to the customer for parts or labor. The customer is, however, responsible for any transportation costs. This warranty does not cover failures due to abuse, misuse, accident or unauthorized alteration or repairs. GARMIN assumes no responsibility for special, incidental, punitive or consequential damages, or loss of use.

The warranties and remedies contained herein are exclusive, and in lieu of all other warranties expressed or implied, including any liability arising under warranty of merchantability or fitness for a particular purpose, statutory or otherwise. This warranty gives you specific legal rights, which may vary from state to state.

To obtain warranty service, call the GARMIN Customer Service department (913-397-8200 M-F 8 a.m. to 5 p.m. CST) for a returned merchandise tracking number. The unit should be securely packaged with the tracking number clearly marked on the outside of the package and sent freight prepaid and insured to a GARMIN warranty service station. A copy of the original sales receipt is required as the proof of purchase for warranty repairs. GARMIN retains the exclusive right to repair or replace the unit or software at its sole discretion.

Preface



INTRODUCTION

Preface

Congratulations on choosing one of the most advanced depth sounding and marine navigation systems available! The GARMIN GPSMAP 135 Sounder combines the proven performance of GARMIN GPS, powerful G-Chart electronic charting, and full featured depth sounding into one unit to create an unsurpassed marine navigation and fishfinding package.

To get the most out of your new navigation and sounding system, take the time to go through this operator's manual and learn the operating procedures for your unit. This manual is broken down into two parts for your convenience.

Part One introduces you to the GPSMAP 135 Sounder and provides a Getting Started tour so that you may become more familiar with the unit. This section will provide you with a basic working knowledge necessary to use the unit to its fullest potential.

Part Two is divided into sections that provide detailed references to the advanced features and operations of the GPSMAP 135 Sounder. This allows you to concentrate on a specific topic quickly, without reading through entire portions of text that you may not need. This section can be used to look up detailed information about the GPSMAP 135 Sounder.

WARNING!

The electronic chart is an aid to navigation and is designed to facilitate the use of authorized government charts, not replace them. Only official government charts and notices to mariners contain all information needed for safe navigation – and, as always, the user is responsible for their prudent use.



INTRODUCTION

Packing List

Before installing and getting started with your unit, please check to see that your package includes the following items. If any parts are missing, please see your GARMIN dealer immediately.

Standard Package*:

- GPSMAP 135 Sounder Unit
- External Antenna and 30' cable
- Power/Data Cable
- Mounting Bracket
- Owner's Manual
- Quick Reference Card

*For assembly part number 010-00092-01, a standard transom-mount transducer is included.

Optional Accessories:

- G-chart Electronic Chart Cartridges
- PC Kit
- In-Hull and Transom-Mount Transducers with or without temperature and speed-over-water capability.

Warning	i
Cautions	ii
Capabilities/Warranty	iii-iv
Preface/Packing List	v-vi
Table of Contents/Keypad Usage	vii-viii
Getting Started	1-19
Section 1: GPSMAP Status Page	20-22
Satellite and receiver status, entering initial positions	
Section 2: Position Page.....	23-24
Position Page description and uses	
Section 3: Sounder Page	25-35
Sounder Page description, zooming, underwater waypoints, and options	
Section 4: Map Page.....	36-44
Map Page description, modes, scales, and options	
Section 5: Navigation Page	45-47
Navigation Page use and options	
Section 6: Main Menu Page	48
Viewing the main menu page and selecting submenus	
Section 7: Waypoints	49-57
Creating, using, and editing waypoints	
Section 8: GOTO/MOB/TracBack Functions.....	58-61
Going to a destination and using GOTO options/TracBack routes	
Section 9: Routes	62-69
Creating, editing, and using routes	
Section 10: Setup Menus.....	70-79
System and navigation setup; timers, alarms and track log	
Section 11: Using G-chart cartridges	80-81
Inserting, removing, and using electronic chart cartridges	



APPENDICES

Appendix A:	82-85
GPSMAP 135 Sounder Installation	
Appendix B:	86-87
Wiring and Specifications	
Appendix C:	88-89
Messages	
Appendix D:	90-92
Map Datums	
Appendix E:	93-94
Navigation/Depth Sounder Terms	
Appendix F:	95
Time Offset Chart	
Appendix G:	96-98
Index	











INTRODUCTION

Keypad Usage

The GPSMAP 135 Sounder's advanced keypad system is designed to allow for fast, convenient selection of navigation options and data entry.

The Getting Started Tour will introduce you to the keypad and provide a 'hands-on' lesson in using the GPSMAP 135 Sounder. We strongly encourage you to take the Getting Started tour before using your unit for actual navigation and fishing.

The GPSMAP 135 Sounder Quick Reference Card contains helpful tips on using the unit and performing various navigation and sounder tasks. It's a good idea to keep the Quick Reference Card nearby whenever you're operating your new GPSMAP 135 Sounder.

	Turns the unit on and off and controls 3-level screen backlighting.
	Scrolls the main pages in sequence and returns display from a submenu page to a main page.
	Captures your present position and displays the mark position window.
	Displays the GOTO waypoint window, allowing you to select the destination waypoint. Press GOTO twice to select a destination waypoint graphically from the map.
	Displays context-sensitive options window. Press MENU twice to display main menu page.
	Activates highlighted fields and confirms menu options and data entry.
	Returns display to a previous page or restores a data field's previous value.
	Adjusts the map and highway scales up and down, and controls the sounder page zoom function.
	Controls the movement of the cursor and is used to select options and positions, and to enter data.
	Marks your present GPS position and instantly sets a return course while providing steering guidance.

Initializing the Receiver

The first time you power up your new GPSMAP 135 Sounder is an important step in getting the best possible GPS performance. The receiver must be given an opportunity to collect satellite data and establish its present position. To ensure proper initialization, the GPSMAP 135 Sounder is shipped from the factory in AutoLocate™ mode, which will allow the receiver to “find itself” anywhere in the world. To speed up the initialization process, we recommend using the graphic initialization process described below, which will usually provide a position fix in about a minute.

Before you initialize, make sure the GPSMAP 135 Sounder unit and antenna have been correctly installed on your vessel according to the instructions in Appendix A.

To turn the GPSMAP 135 Sounder on:

1. Press and hold the  key until the power tone sounds.



The welcome page will appear while the unit conducts a self test. Once the internal test is complete, the mariner's warning will appear, asking you to read and acknowledge important information regarding the proper use of electronic charts.

To acknowledge the mariner's warning:

1. Press the  key.

A message alert and prompt will also appear to ask you to select an initialization method.

To view a system message:

1. Press the  key.
2. Press the  key again to return to the previous page.

GETTING STARTED

Initialization

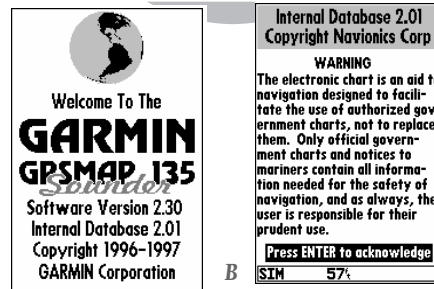

- A. The welcome page will be displayed while the unit performs a self-test.
- B. Confirm the Mariner's Warning before starting navigation. Remember that the electronic chart is designed as a supplement to local government charts, not as a replacement.

GETTING STARTED

Initialization

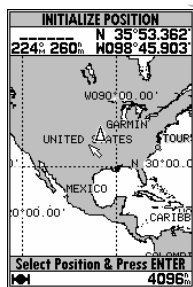

A

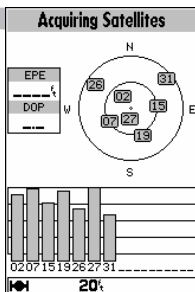

B

A. Use the arrow keypad to move the cursor to a location close to your present position.

B. Hollow signal strength bars will appear on the status page while the receiver collects satellite data.

The select initialization window will appear, with the 'select from map' option highlighted.

1. Press **EDIT ENTER** to initialize the receiver from the built-in worldwide map.

The map page will appear, prompting you to select your approximate present position with the map cursor.

1. Use the **⬇** keypad to move the map cursor to a location close to your present position. If you have difficulty identifying your exact position, use the bottom arrow of the **⬇** key to zoom in to a lower map scale.

2. Press **EDIT ENTER** to confirm your selection.

The GPSMAP 135 Sounder will now begin searching for the appropriate satellites for your present position and should acquire a fix within a minute or so. While the receiver searches for satellites, a flashing satellite icon will appear at the left-hand side of the status bar located at the bottom of the screen. The status bar is used to monitor the current status of functions such as satellite signal reception, activated alarms, and also constantly shows the digital depth. A signal strength bar for each satellite in view will appear on the lower half of the page, with the appropriate satellite number under each bar. The progress of satellite acquisition is shown in three stages:

- **No signal strength bars**— the receiver is looking for the satellites indicated.
- **Hollow signal strength bars**— the receiver has found the indicated satellite(s) and is collecting data.
- **Solid signal strength bars**— the receiver has collected the necessary data and the satellite(s) is ready for use.



Once the receiver has collected information from at least three satellites, the flashing satellite icon on the status bar will glow steadily, and the GPSMAP 135 Sounder is ready for use.

GPSMAP 135 Sounder Getting Started Tour

The GARMIN GPSMAP 135 Sounder is a powerful electronic navigation and depth sounding system that provides detailed chart coverage and convenient control of many advanced features right from the screen display. This tour is designed to take you through the basic pages and functions of the system using the simulator mode. Once you're familiar with the main pages and functions of the unit, refer to the reference section for instructions on performing specific tasks and functions.



The Getting Started tour assumes that the receiver has been properly installed and initialized, and you have not changed any of the default unit settings. If you have changed any settings (position formats, units of measure, etc.), the descriptions and pictures in the tour may not match your configuration.

To turn the GPSMAP 135 Sounder on:

1. Press and hold the  key until the power tone sounds. The welcome page will appear while the unit conducts a self test.
2. Once the self test is complete, press the  key to acknowledge the mariner's warning.

The satellite status page will appear as the receiver begins acquiring satellites. From the status page, you may also adjust the screen contrast and backlighting.

To adjust the screen contrast:

1. To increase the screen contrast, press the right arrow of the  keypad.
2. To decrease the screen contrast, press the left arrow of the  keypad.
3. Press the  key to finish.

The GPSMAP 135 Sounder's three-level screen backlighting is controlled with  key, and may be adjusted at any time from any page.

To turn on and adjust the backlighting:

1. Press the  repeatedly until the backlighting is at the desired level (off, 1, 2, or 3).

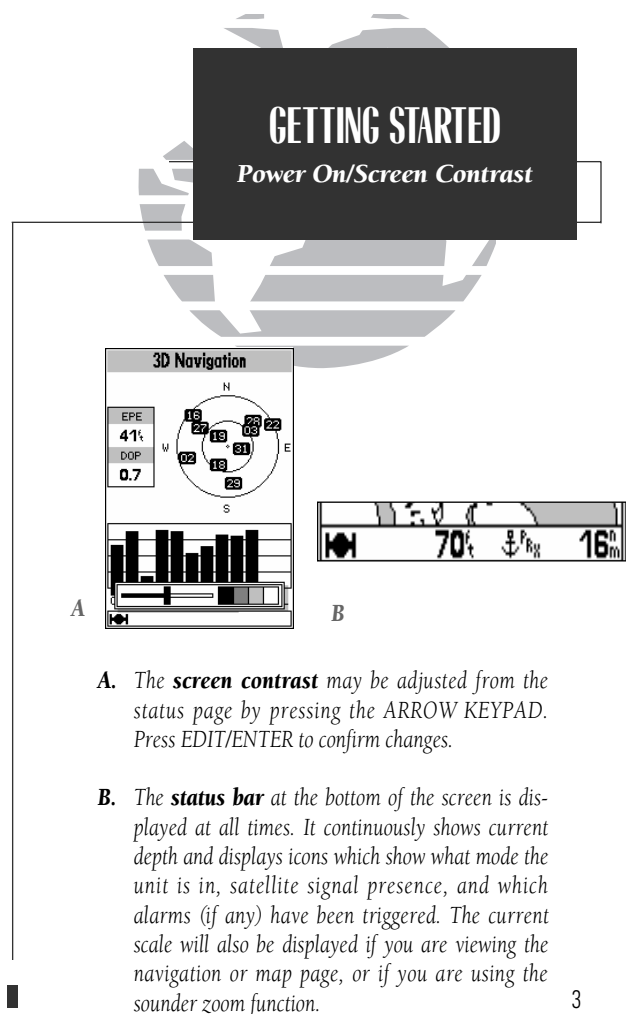

- A. The **screen contrast** may be adjusted from the status page by pressing the ARROW KEYPAD. Press EDIT/ENTER to confirm changes.
- B. The **status bar** at the bottom of the screen is displayed at all times. It continuously shows current depth and displays icons which show what mode the unit is in, satellite signal presence, and which alarms (if any) have been triggered. The current scale will also be displayed if you are viewing the navigation or map page, or if you are using the sounder zoom function.

GETTING STARTED

Status Page/Simulator Mode

Warning: Do not use this mode for navigation or fishing

Are You Sure?

YES **NO**

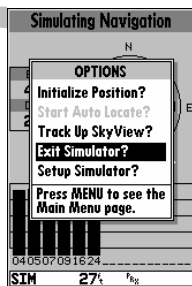

A

B

- A. To start the simulator, confirm the simulator warning. Simulator mode should never be used for actual navigation.
- B. Whenever the GPSMAP 135 Sounder is in simulator mode, a 'Setup Simulator?' option will appear on the options menu for each page. An 'Exit Simulator?' option will also appear on the status page options menu.

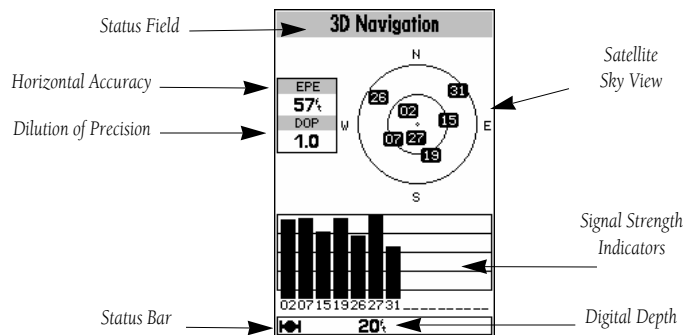

The GPSMAP 135 Sounder's **status page** provides a visual reference of satellite acquisition and receiver status, with a signal strength bar graph and a satellite sky view in the center of the page. Each page of the GPSMAP 135 Sounder's system also features an options page, which gives you access to other functions and features that relate to the specific page you are viewing. To get a feel for how the options pages work, let's put the GPSMAP 135 Sounder into simulator mode.

To place the GPSMAP 135 Sounder in simulator mode:

1. From the status page, press the **MENU** key. The options page will appear, displaying a menu of options and functions for the status page.
2. Use the UP or DOWN arrow of the **⬇** keypad to highlight the 'Start Simulator?' option and press **EDIT ENTER**.
3. Press the **EDIT ENTER** key to confirm the simulator warning.

Once the simulator has been started, the status field at the top of the page will display a 'Simulating Navigation' status. Now you're ready to continue the rest of the tour. Keep in mind that the GPSMAP 135 Sounder does not track satellites in simulator mode, and this mode should never be used for actual navigation or to determine the water depth. All the waypoint and route planning done in simulator mode will still be retained in memory for future use.

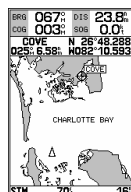
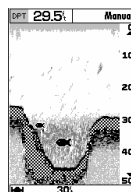
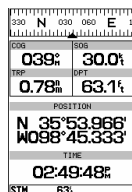
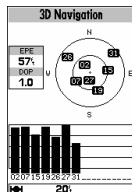

The satellite status page is one of five main pages used in the GPSMAP 135 Sounder's system. All five pages are linked together in a simple chain, which allows you to scroll through the pages in either direction using the **PAGE** and **QUIT** keys. To continue the tour, let's move on to the next page, the position page.

To scroll to the next page in sequence:

1. Press the **PAGE** key.

The GPSMAP 135 Sounder's **position page** shows where you are, what direction you're heading and how fast you're going. The compass tape at the top of the page indicates the direction you're moving. The four user-selectable data fields below the compass tape show your current course and speed over ground, along with a resettable trip odometer and depth display. Your current latitude and longitude, along with a 12/24-hour clock, appear at the bottom of the page.

Now that you've seen how the status and position pages can be used to monitor satellite acquisition and your present position, let's take a minute to learn how to mark and store our present position as a waypoint. (Since we're in simulator mode, the present position displayed will be the last position calculated by the receiver, which should be the spot where you've initialized the unit.) This will also give you an opportunity to see how the GPSMAP 135 Sounder's **EDIT/ENTER** key and **EDIT/ENTER** key are used for data entry.

Compass
Tape

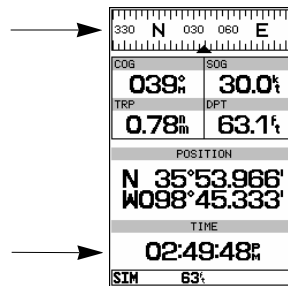

Data
Fields

Position
Coordinates

Time
of Day

Status Bar

GETTING STARTED

Marking A Position

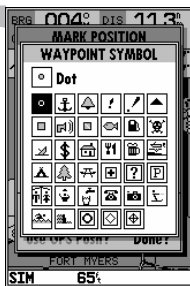
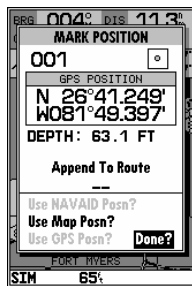

A

B

- A. The mark position page will automatically assign a default three-digit name for each waypoint, which can be changed at any time to an alphanumeric name containing up to six-characters.
- B. A complete set of waypoint symbols allows you to mark inland and offshore waypoints with a custom icon for fast waypoint recognition.

To mark your present position:

1. Press the **MARK** key. The mark position page will appear, with a default three-digit waypoint name, symbol, position, and depth (at this position).
2. Use the **0** keypad to highlight the waypoint name field (001) and press **EDIT ENTER**.
3. Press the LEFT ARROW of the **0** keypad to clear the name field.



4. Use the **0** keypad to enter the name 'DOCK', using the UP and DOWN arrows to select each letter, and the RIGHT arrow key to advance to the next character position. If you make a mistake and select an incorrect character, simply use the LEFT arrow key of the **0** keypad to backspace the cursor and correct the entry.
5. Press **EDIT ENTER** to confirm the name.
6. The field highlight will advance to the symbol field. Press **EDIT ENTER** to access the waypoint symbol page.
7. Use the **0** keypad to highlight the ANCHOR symbol.
8. Press **EDIT ENTER** to confirm the symbol.
9. Press **EDIT ENTER** again to confirm the 'DONE?' prompt and save the waypoint.

The waypoint is now stored in memory. Note that waypoints may also be created graphically from the map display, by manually entering position coordinates, or as underwater waypoints from the sounder page. Each of these techniques is described in the reference section of the manual and/or on your GPSMAP 135 Sounder quick reference guide. To continue our tour, let's move on to the sounder page.

1. Press the **PAGE** key.

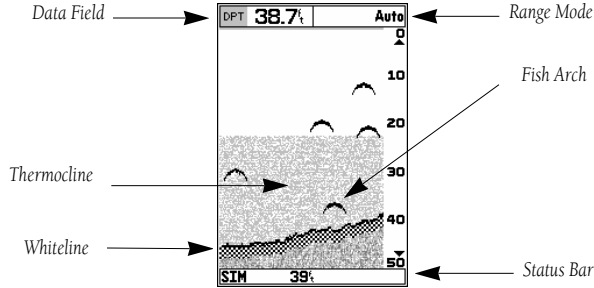

The **sounder page** lets you use the GPSMAP 135 as a fishfinder. The top of the screen contains any of seven selectable data field options, while the middle of the page contains a right-to-left moving sonar image of the water beneath your boat. (Note: Items appear on the screen as they pass under your transducer. Those objects appearing on the right side of the screen are closer to you than those on the left.) **Fish** are displayed as a darkened arch or a fish icon in three different sizes. **Thermoclines** (layers of water separating warmer water above from cooler water below) are shown as shades of gray.

The area of strongest sonar return (or **whiteline**) is displayed as a mix of light and dark checkering. Typically, the bottom will be the primary source of the whiteline. A thin whiteline indicates a softer bottom while a thick whiteline shows a harder bottom. A **black line** is used to show the point where water meets the whiteline. This black line will follow the bottom contour, along with any significant objects lying on the bottom. Along the right side of the screen is an **adjustable scale** which reflects the depth of the area being displayed. The **status bar** at the bottom of the page displays satellite signal status, digital depth, and any triggered alarms. More on the sounder page may be found on pages 25-35.

GETTING STARTED

Sounder Page

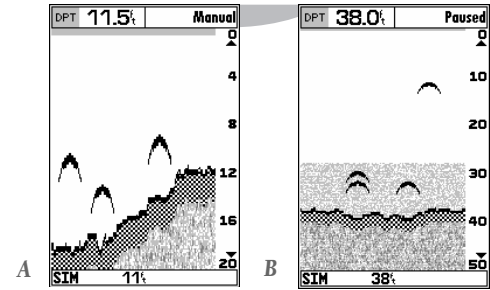

- A. When adjusted correctly, the bottom is outlined by the whiteline. To adjust the whiteline, see page 30.
- B. Pause the screen by pressing the EDIT/ENTER key at any time. To continue screen movement, press EDIT/ENTER again.

Pausing is used to allow more time to examine the screen display and is necessary when using the underwater waypoint function.

GETTING STARTED

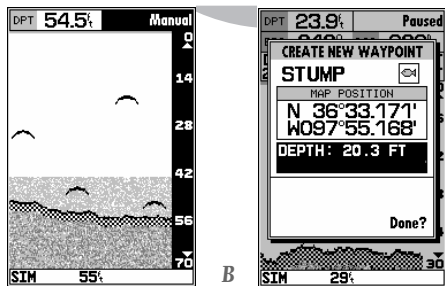

Sounder Page





- A. When switching between auto and manual modes, the range scale will be highlighted.
- B. The digital depth of the waypoint is captured with the underwater waypoint function.

The GPSMAP 135 Sounder uses three range modes: auto, manual, and window. **Auto** mode displays the most information possible while continuously showing the bottom. **Manual** mode lets you select the displayed depth. **Window** mode allows you to define a starting depth and length of the range window. You may switch between auto and manual modes by using the  keypad. Window range mode, however, must be activated from the sounder options menu (see page 31).

To switch from auto to manual mode:







1. Press the  keypad up or down until the desired depth range is displayed on the depth scale at the right side of the page.
2. Press  to confirm the selected range.

To switch from manual to auto mode:

1. Press the  up or down and hold it until you hear a repeated beep. 'Auto' will be displayed in the function field at the top right corner of the page.
2. Press .

The **underwater waypoint** feature marks a waypoint's position and its depth. This makes it easier to find and use an object such as a stump for a future fishing location.

To mark an underwater waypoint:

1. Press  to pause the screen movement.
2. Use the  keypad to move the cursor onto the target (underwater drop off, stump, etc.) you want to mark. A data field will appear with the cursor's depth and bearing and distance from your current position.
3. Press . A waypoint page will appear with the waypoint's coordinates, default three-digit name, and depth.
4. Enter any waypoint information such as name, comment, etc., and press .
5. When finished, press  or .



Another useful feature of the GPSMAP 135 Sounder is the **sounder zoom**, which allows you to instantly “zoom in” to look at a specific portion of the sounder display by using the  key. The sounder zoom function is divided into four display levels:

- 2X Split Screen—Shows two reduced-size sonar pictures at the same time. The top half of the display screen shows the complete sonar picture at its original scale. The bottom half shows a portion of the original picture at 1/2 depth scale.
- 2X Full Screen—Displays the 2X zoomed picture on the full GPSMAP 135 Sounder screen and does not show the original scale picture.
- 4X Split Screen—Shows two reduced pictures, with one at the original depth scale and one at 1/4 the original depth scale.
- 4X Full Screen—Displays only the 4X zoomed picture on the full GPSMAP 135 Sounder screen.

Once activated, the zoomed picture becomes the sounder page display. Note: the zoom function can only be deactivated by pressing the  key up until the original scale picture appears. Pressing **QUIT** will not turn off the zoom function.

The zoom function operates in either auto zoom or manual zoom. Auto zoom will follow the bottom contour while manual zoom will display the selected depth.

To access the sounder zoom function:

1. While viewing the sounder page, press  down once. The 2X split screen will appear. (Note: the current zoom scale will be displayed on the status bar at the bottom of the screen).
2. Continue to press  down to advance to further zoom screen levels.
3. To deactivate the sounder zoom function, press  up until the original scale picture appears and a triple beep sounds.

For more on the zoom function, see pages 27-29.

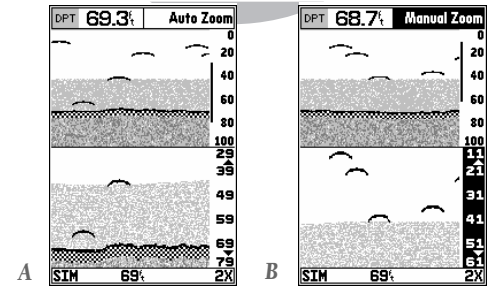

- A. Use the zoom window to view a smaller portion of the complete range in greater detail.
- B. Moving the zoom window allows you to view anywhere between the surface and the bottom quickly. See page 28 for directions on moving the zoom window.

GETTING STARTED

Map Page

Let's continue the Getting Started Tour with the map page.

1. Press the **PAGE** key.

The GPSMAP 135 Sounder's **map page** combines digital chartplotting with a user-selectable display of navigation data and a built-in worldwide database to 64 nm. It will also be the page you use most to create and edit waypoints and routes. Before we take off on our practice route, let's take a brief look at its various features and displays.

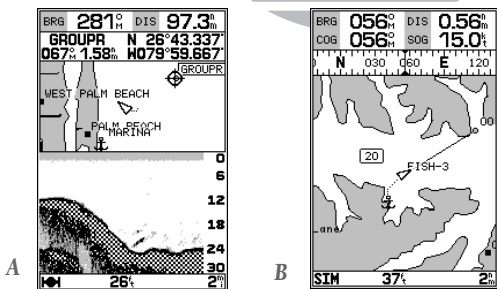

A. The map/sounder split screen displays cartography and sounder information at the same time. The split screen functions as a map page only and any changes to the sounder display must be made from the sounder page. Use the QUIT or PAGE key to quickly switch between the map split-screen and the sounder page.

B. The map page can also be configured to display additional data fields and a graphic course deviation scale or compass. See page 40 for more on map options.

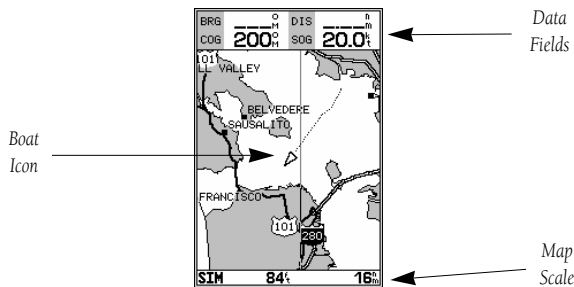





The **map display**, located in the middle of the page, shows your boat as a triangle marker on an electronically generated chart. Geographic names, markers and buoys that are provided by the G-chart cartridge you're currently using are also shown. It also displays your track, routes and nearby waypoints. An on-screen **cursor** lets you pan to other map areas, determine the range and bearing to a position, and perform various waypoint and route functions.

The **data window**, located at the top of the page, provides a user-selectable display of various navigation data, including course, speed over ground, and bearing and distance to the cursor or a particular waypoint. The status bar, located at the bottom of the page, displays the current map scale setting, as well as the status information described on page 21.

Using the Map Cursor

Working from the map page is a simple process that centers around the use of the cursor. Controlled by the  keypad, the cursor is an important tool that can be used to pan to other map locations, mark and edit waypoints and routes, and review position data of on-screen nav aids and waypoints.

To get a feel for using the map page and using the cursor, try the following exercise:

1. Use the DOWN arrow of the  key to set the map scale to the 64 nm setting. Your boat should be near the center of the map, at the receiver's last known position. (If your boat isn't where it should be, make sure that you have initialized the receiver and acquired a position as described on pages 1-2.)
2. Use the DOWN arrow of the  keypad to move the cursor down to the first lat/lon grid south of your boat's position.
3. Using the  keypad to move the cursor, try following the outline of the lat/lon grid closest to your boat. Notice how another data field appears at the top of the page, showing the bearing and distance from your boat to the cursor, along with the lat/lon of the cursor.
4. Press the  key to remove the cursor and recenter your boat on the map display.

As you become more familiar with the cursor, you'll see that the map display actively scrolls or 'pans', letting you explore areas around the world (even outside of your current G-chart coverage) and create waypoints and routes. Wherever you move the cursor, you'll always be just one  keystroke away from returning the map to your present position.

Now that you have a feel for how the cursor works, let's move on and see how the GPSMAP 135 Sounder works on the water. To help you practice using the map page and other features, we've stored a practice route in the receiver's permanent memory so you can see exactly what you'll experience when you're navigating with your new GPS chartplotter.

GETTING STARTED

Map Cursor

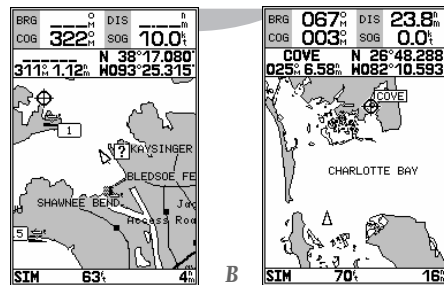

A. Whenever the cursor is active, the bearing and distance of the cursor from your present position will appear in a pop-up data window. To remove the cursor and recenter your vessel on the map, press the QUIT key.

B. To select an on-screen waypoint, simply move the cursor over the desired waypoint. The waypoint/navaid name and position, along with the bearing and distance from your present position, will be displayed. Note: Underwater waypoints are also shown on the map.

GETTING STARTED

Using the GOTO Function

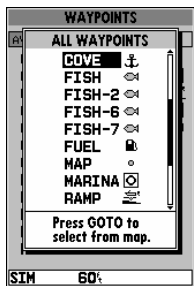

- A. Pressing GOTO once displays a list of all waypoints stored in memory. To pick a destination, select the desired waypoint and press EDIT/ENTER.
- B. The GOTO options page allows you to either start a TracBack route back home, select a destination from the nearest waypoints list, or select a route to navigate.

Going to a Destination

GPS is all about marking positions as waypoints and navigating to them using the receiver's steering guidance and map displays. We've already seen how to use the **MARK** key to store our present position, so it's time to move on to the fun part—going to a destination. The **GOTO** key, located on the left side of the keypad above the **QUIT** key, is the primary tool used to select a destination waypoint or a route to navigate. The **GOTO** key can be used in three primary ways:

- Pressing **GOTO** once displays a list of all waypoints in memory, from which you can select a single destination waypoint.
- Pressing **GOTO** followed by the **MENU** key provides a list of GOTO options that lets you start a TracBack™ route, select a destination waypoint from the nearest waypoints list, select a stored route to navigate, or cancel the current GOTO destination.
- Pressing **GOTO** twice allows you to graphically select an on-screen waypoint, navaid or cursor position as a destination directly from the map display.

For our simulated trip, we're going to select the pre-programmed tour route [the second method], which will automatically place our vessel at the first route waypoint. This will also give us an idea of how the **MENU** key is used throughout the GPSMAP 135 Sounder system to provide context-sensitive options and functions. Let's give it a try by activating the practice route stored in memory for navigation:

1. Press **GOTO**. The waypoint list page will appear. (If we were selecting a single waypoint to navigate to rather than a route, we would highlight the waypoint and press **EDIT/ENTER**.)
2. Press **MENU** to display the context-sensitive options available for the GOTO function.
3. Use the **DOWN** keypad to highlight the 'Select Route?' option. Press **EDIT/ENTER** to confirm.
4. The select route page will appear, with the 'GPSMAP TOUR' route highlighted.
5. Press **EDIT/ENTER**. The map page will reappear and display five waypoints chained together in a simple route, with your boat at the first route waypoint.

GETTING STARTED

Simulator Setup/Map Scales

A **data field** at the top of the page will now display the bearing and distance to the second route waypoint. To get started, let's enter a speed for our vessel, which we can do from the "Setup Simulator?" listing on the options page. The **setup simulator page** is also available from any other page in the main page sequence.

To enter a boat speed:

1. Press the **MENU** key to display the map options page.
2. Use the **⬇️** keypad to select the 'Setup Simulator?' option and press **EDIT**.
3. Once the setup simulator page appears, press **EDIT** to access the SOG field.
4. Use the **⬇️** keypad to enter a speed of 60 knots.
5. Press **EDIT** to finish, and **PAGE** to return to the map display.

Once a speed has been entered, you'll notice that the map will begin to move slowly, keeping your boat centered on the display. To get a better view of what's going on, zoom in to a closer map scale.

1. Press the DOWN arrow of the **⬇️** key to select the 16 nm scale.

You'll now have a clearer picture of the route we are navigating, along with an outline-only presentation of the surrounding shoreline. Because the usable range of the built-in database is only valid to 64 nm scale, we no longer have full cartography available. Keep in mind that whenever you do exceed the usable range of the built-in database or the G-chart cartridge in use, the range field will display 'OVR ZM' or 'NO MAP' to indicate that you should exercise extreme caution using the cartography data. See pages 39 and 81 for more information on map scales and using G-chart detailed cartography.

Now that we've zoomed in a little closer to our route, we can pan ahead of our vessel with the cursor to review and create on-screen waypoints and nav aids. Try moving the cursor to select the 'TOUR3' waypoint— just use the **⬇️** keypad to move the cursor as close as possible to the waypoint. (To move the cursor in small increments, try a series of short key presses.)

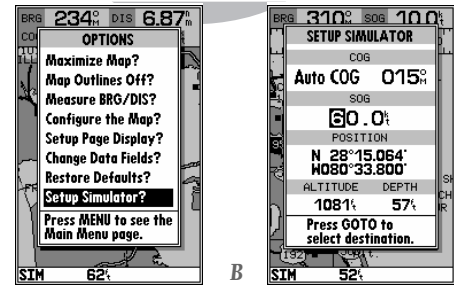

- A. To enter a boat speed or define the simulated course, highlight the "Setup Simulator?" option and press EDIT/ENTER.
- B. Enter a boat speed of 60 knots to begin the tour. This will allow you to complete the Getting Started tour in 10-15 minutes.

GETTING STARTED

Reviewing and Creating Waypoints on the Map

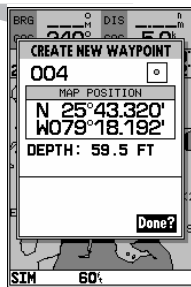
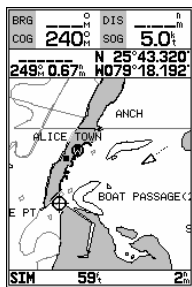

A

B

- A. Waypoints can be created from the map display by moving the cursor to the desired position and pressing the EDIT/ENTER key.
- B. The create new waypoint page will automatically assign the next available three-digit number as the default waypoint name. If you are creating a waypoint at an on-screen navaid, the navaid icon and name will be used as the default symbol and comment.

Once the cursor is over the TOUR3 waypoint, you'll notice that the waypoint symbol and name will become highlighted. The data field at the top of the page will display the waypoint name, the range and bearing from your present position, and the coordinates for the waypoint.



To review the waypoint page for a selected waypoint:

1. Press the **EDIT/ENTER** key.
2. To return to the map page, press **EDIT/ENTER** again.

The cursor can also be used to create new waypoints right from the map display.

To create a new waypoint using the cursor:

1. Use the **⬇** keypad to move the cursor as close as possible to the following position: N 35° 02.129'; W 076° 26.106' (Use the data window to verify the cursor position.)
2. Press the **EDIT/ENTER** key to capture the cursor position.
3. Use the **⬇** key to highlight the waypoint symbol field.
4. Press **EDIT/ENTER** to access the symbol page.
5. Press the DOWN arrow of the **⬇** keypad twice to select the wreck symbol.
6. Press **EDIT/ENTER** to confirm, and **EDIT/ENTER** again to finish.

Now that we're navigating to an actual destination, let's move on to the next page of the GPSMAP 135 Sounder system, the **navigation page**:

1. Press the **PAGE** key.

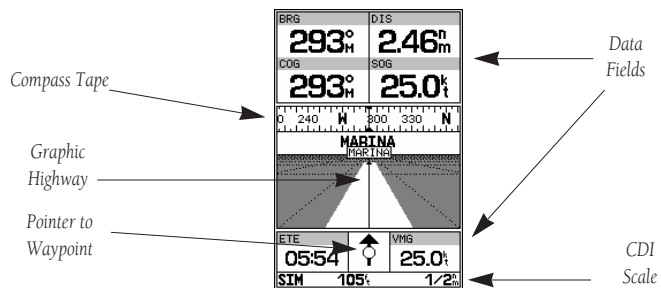

The navigation page provides graphic steering guidance to your destination. The **bearing (BRG)** and **distance (DIS)** to the destination, with your current **course (COG)** and **speed over ground (SOG)**, are displayed at the top of the page, along with a compass tape to indicate your cardinal heading. The **estimated time enroute (ETE)** and **velocity made good (VMG)**, or the rate you are closing in on your destination) are displayed at the bottom of the page.

As you head toward the destination, the middle section of the page gives you visual guidance to your waypoint on a **graphic highway**, which displays the route and nearby waypoints on screen. The moving arrow below the highway always points to the destination waypoint relative to the direction you're moving. The line down the center of the highway represents your desired track, while the bottom of the page provides a graphic indication of your **crosstrack error** (the distance and direction you are off course) according to the scale at the bottom right of the page.

Whenever the GPSMAP 135 Sounder is in simulator mode, you can adjust your speed and course from the navigation page using the **⬇** keypad. As you head toward each waypoint in the tour route, try adjusting your boat speed and course to get a feel for how the highway works.

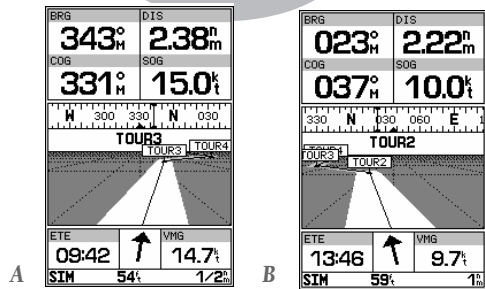

- In this example, our boat is off course to the left by about 1/8th of a mile (the base of the highway map is equal to the scale selected at the bottom right of the page). To get back on course, steer right.
- In this example, our boat is off course to the right. To get back on course, steer left. A digital readout of your exact crosstrack error can be displayed in any of the six data fields (see page 47).

GETTING STARTED

Using the Navigation Page

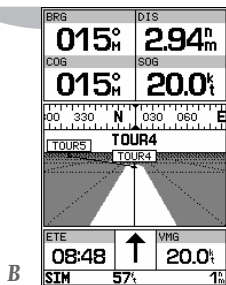

To adjust the simulated boat speed:

1. Press the UP arrow of the keypad to increase the speed in 5 knot/kph/mph increments. Press the DOWN arrow to decrease the speed in the same increments.

To steer the boat:

1. Press the LEFT and RIGHT arrows of the keypad.

Notice that as you get off course, the highway and waypoint pointer move to give you graphic guidance to get back on course. The scale in the lower right corner of the page represents the total distance (or the width) of the base of the highway display. The default graphic highway setting is 1/4 nm, but can be set for a 1/2-, 1-, 2- or 4-nm range.

To change the highway scale display:

1. Press the key in either direction (up to increase, down to decrease the scale).

The navigation page data fields may also be configured to display any of eight different navigation information categories. Let's change the ETE field to ETA (estimated time of arrival).

To change a data field:

1. Press the key to display the position page options.
2. Highlight the 'Change Data Fields?' option and press . The field highlight will now appear in the top-left data field (the COG field).
3. Use the keypad to move the field highlight to the ETE field and press .
4. Highlight the 'ETA' option and press , and press to finish.

Now that you've seen the five main pages, let's look at the **active route page**, which appears in the main page sequence whenever you are navigating a route:

1. Press the key.

- A. To reset the simulator to steer the desired course automatically, select the 'Auto COG' setting from the options page.
- B. The highway scale can be set to a 1/4-, 1/2-, 1-, 2-, or 4-nm/mi/km range with the ZOOM keys.

The active route page shows each waypoint of the active route in sequence, with the waypoint name, distance and estimated time enroute to each waypoint displayed. As you navigate the route, the active route list will be automatically updated, indicating the next destination waypoint.

The active route page also provides quick access to many route activation, editing and copying functions you'll use most often, like inverting and deactivating the active route. Let's go ahead and deactivate the active route.

To deactivate the active route and stop navigation:

1. Press the **MENU** key.
2. Highlight the 'Deactivate Route?' option.
3. Press **EDIT/ENTER** to confirm.

To reset the boat speed to zero:

1. Press the **MENU** key.
2. Highlight the 'Setup Simulator?' option.
3. Press **EDIT/ENTER**.
4. Press **EDIT/ENTER** to access the SOG field.
5. Press the LEFT arrow of the **0** keypad to clear the speed entry.
6. Press **EDIT/ENTER**.

As you've seen, the primary pages provide status, position, fishfinding, navigation and map information. The tour's last page is the **main menu** page, which allows access to the GPSMAP 135 Sounder's waypoint, route and planning functions, as well as various operational and navigation setup features. The main menu is available from any page, and is accessed through the **MENU** key.

GETTING STARTED

Active Route Page

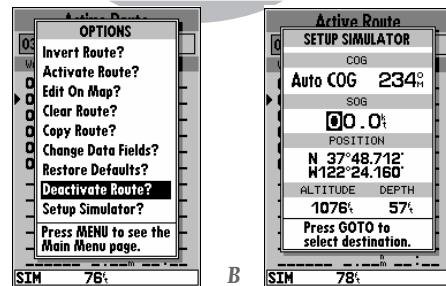

- A. To stop navigating the active route, select the 'Deactivate Route?' option and press EDIT/ENTER.
- B. Use the left arrow key to clear the SOG field and press EDIT/ENTER to confirm.

GETTING STARTED

Main Menu/Track Log

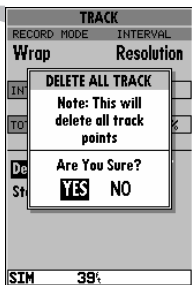
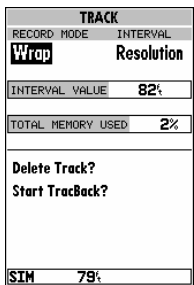

- A. The GPSMAP 135 Sounder's track page lets you clear the track log and start a TracBack route.
- B. To delete the track log, confirm the warning page by highlighting the 'YES' prompt and pressing EDIT/ENTER.

To access the main menu page:

1. Press the **MENU** key twice.

The main menu page's 11 submenus are divided into categories by function. You can select a particular submenu by simply highlighting the desired option and pressing **EDIT/ENTER**. To get a feel for how the main menu page works, let's clear out the track log we've created during our simulated tour. This will ensure that you have a clean slate once you start navigating in your home waters.

To select the track submenu:

1. Highlight the 'Track' menu option and press **EDIT/ENTER**.

The track log page allows you to specify whether to record a track plot and define how it is recorded. It also provides both an indicator of the total memory used and the individual functions to clear the track log and start a TracBack route.

To delete the track log:

1. Highlight the 'Delete Track' option and press **EDIT/ENTER**. A confirmation page will appear.
2. Highlight the 'Yes' prompt and press **EDIT/ENTER** to confirm.
3. Press **PAGE** to return to the main page sequence.

Congratulations! You've now gone through the basic operation of the GARMIN GPSMAP 135 Sounder. Your new digital chartplotter is a powerful tool with many advanced features not covered in the Getting Started tour. For detailed instructions on using these features or performing a specific task, please refer to the quick reference guide or the appropriate reference section of this manual.



To turn the GPSMAP 135 Sounder off:

1. Press and hold the  key for about 3 seconds, until the screen is blank.

The next section of the manual describes the pages and functions of the GPSMAP 135 Sounder in detail. If you are unable to locate a specific option or function, please refer to the index on pages 96-98.

Thank you for choosing the GARMIN GPSMAP 135 Sounder navigation and depth sounding unit. We hope that it will be a useful tool for you wherever you drop a line.

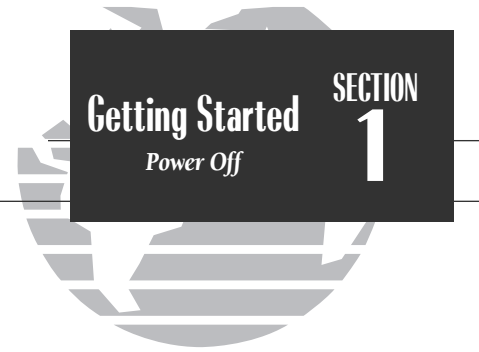

SECTION 1 STATUS PAGE

Receiver Status

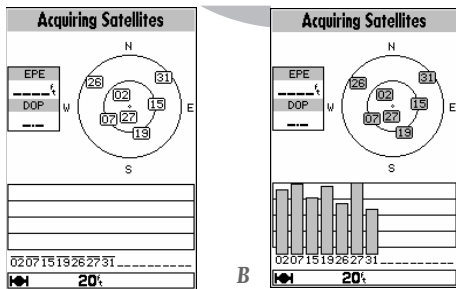

- A. Whenever the GPSMAP 135 Sounder is searching for satellites, no signal strength bars will appear.
- B. Once the receiver has found the satellite(s) indicated, a hollow signal strength bar will appear. After satellite data has been collected, the signal strength bars will become solid.

Status Page

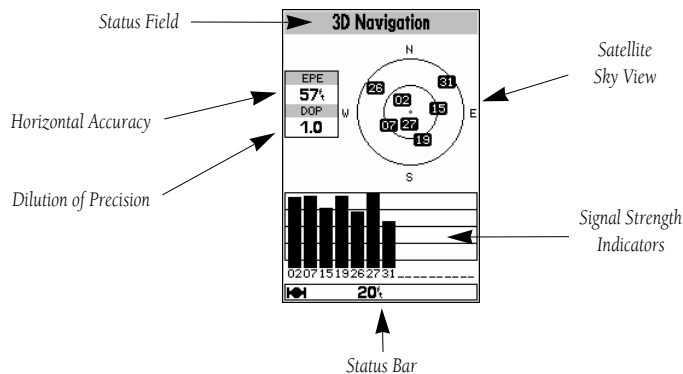

The GPSMAP 135 Sounder **status page** provides a visual reference of various receiver functions, including current satellite coverage, receiver operating mode and current receiver accuracy. The status information will give you an idea of what the receiver is doing at any given moment.

The **sky view** and **signal strength bars** give you an indication of what satellites are visible to the receiver and whether or not they are being tracked. The signal strength is shown on a bar graph for each satellite, with the satellite number below. When a satellite is visible but not being tracked, the strength bar will not be shown and the sky view indicator will not be highlighted.

The sky view shows a bird's-eye view of the position of each satellite relative to the receiver's last known position. The outer circle represents the horizon (track up), the inner circle 45° above the horizon, and the center point a position directly overhead. Use the sky view to determine if there are obstructions shading your reception of GPS signals.

Receiver Status, EPE & DOP

Receiver status is indicated at the top of the page, with the current **estimated position error (EPE)** and **dilution of precision (DOP)** to the left of the sky view. DOP is an indication of satellite geometry quality measured on a scale of one to ten (lowest numbers the best, highest numbers the poorest). EPE uses DOP and other factors to calculate a horizontal position error in feet or meters. The status field will show one of the following conditions:

- **Searching the Sky**— the receiver is looking for any satellites.
- **AutoLocate**— the receiver is looking for any satellite whose almanac has been collected. This process can take up to five minutes.
- **Acquiring Satellites**— the receiver is looking for and collecting data from satellites visible at its last known or initialized position, but has not collected enough data to calculate a fix.
- **2D Navigation**— at least three satellites with good geometry have been acquired and a 2 dimensional position fix (latitude and longitude) is being calculated. '2D Differential Navigation' will appear when you are receiving DGPS corrections in 2D mode.
- **3D Navigation**— at least four satellites with good geometry have been acquired and your position is now being calculated in latitude, longitude and altitude. '3D Differential Navigation' will appear when you are receiving DGPS corrections in 3D mode.
- **Poor GPS Coverage**— the receiver is no longer tracking enough satellites for a 2D or 3D fix.
- **Receiver Not Usable**— the receiver is unusable, possibly due to incorrect initialization or abnormal satellite conditions. Turn the unit off and back on to reset.
- **Simulating Navigation**— the receiver is in simulator mode.

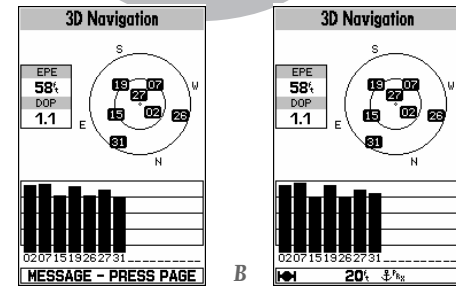
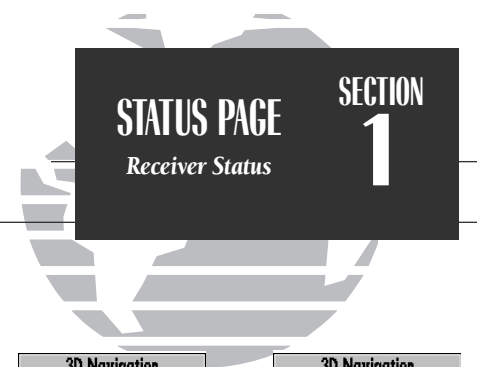

- A.** The status bar at the bottom of the page displays important status, alarm and map scale information. It also provides on-screen user and message prompts.
- B.** The status bar will display an anchor symbol or 'PRX' icon whenever the anchor drag alarm or proximity alarm has been triggered.

SECTION 1

STATUS PAGE Options

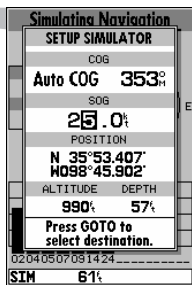
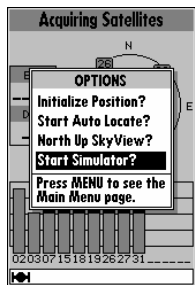

- A. Whenever the GPSMAP 135 Sounder is in simulator mode, the 'Setup Simulator?' option will appear on the option menu for each of the main pages.
- B. The setup simulator page allows you to define your speed and course over ground, as well as your position, altitude, and depth. The 'Auto COG' option will automatically steer the desired course to your destination. Your speed and course can also be selected from the navigation page using the rocker keypad (see page 16).

Status Page Options



The GPSMAP 135 Sounder's status page features a context-sensitive options page that provides access to functions and features relating to the status page.

To display the status page options:

1. Press **MENU**.

To select a menu option:

1. Highlight the desired option and press **EDIT/ENTER**.

The following options are available:

- **Initialize Position?**— allows you to initialize the receiver graphically or by text. See pages 1-2 for instructions on initialization.
- **Start AutoLocate?**— allows the receiver to locate your position automatically.
- **Track Up/North Up SkyView?**— allows you to select between a north up or track up sky view display.
- **Setup Simulator?**— allows you to define speed, course and position values while in simulator mode. See the Getting Started Tour for more on using simulator mode.

Position Page

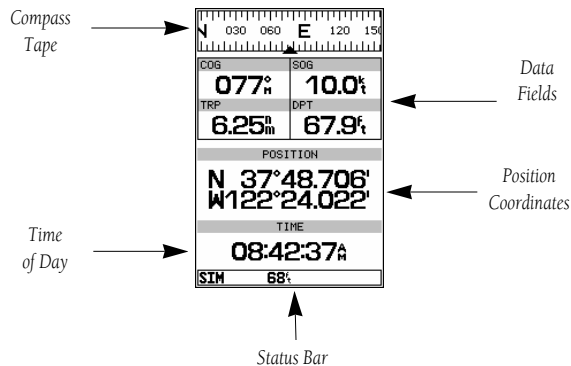

The GPSMAP 135 Sounder position page shows you where you are, what direction you are heading and how fast you are going. The top of the page features a compass tape to indicate the direction you're heading (while you're moving), and four user selectable data fields: course over ground (COG), speed over ground (SOG), distance traveled (TRP) and altitude (ALT). The bottom half of the page displays your present position's coordinates, along with the time of day as calculated using GPS satellites. The status bar at the bottom of the page indicates position fix status, and is described in detail on page 21.

The units of measure for speed, distance, position and altitude are all user-selectable through the navigation setup option on the main menu page. The time of day, shown in UTC (Universal Time Coordinated, or Greenwich Mean Time) may be set to display in a 12- or 24-hour time format (with a local offset) through the system setup option on the main menu page.

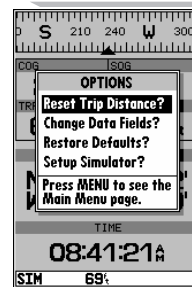

The trip odometer can be reset from the position page options window. To reset the odometer, select the "Reset Trip Distance?" option and press EDIT/ENTER.

SECTION 2 POSITION PAGE Options

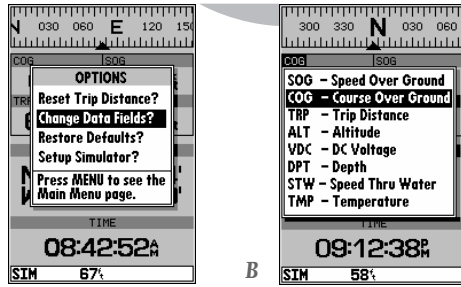

- A. The four data fields at the top of the position page can be changed by selecting the 'Change Data Fields?' option.
- B. Each data field can be set to display speed over ground, course over ground, distance traveled, altitude, DC voltage, depth, speed through water and temperature display are available if you are using a properly equipped transducer.

Position Page Options

The GPSMAP 135 Sounder's position page features a context-sensitive options page that provides access to functions and features relating to the position page.

To display the position page options:

1. Press **MENU**.

To select a menu option:

1. Highlight the desired option and press **EDIT ENTER**.

The following options are available:

- **Reset Trip Distance?**— resets the trip odometer (TRP) field to zero.
- **Change Data Fields?**— allows you to choose the data displayed in the four user-selectable data fields. Eight data types are available:
 - SOG— speed over ground
 - ALT— altitude
 - VDC— DC voltage
 - COG— course over ground
 - TRP— distance traveled
 - DPT— depth
 - STW— speed through water
 - TMP— temperature

To change a data field:

1. Highlight the 'Change Data Fields?' option and press **EDIT ENTER**.
2. Move the field highlight to the field you want to change and press **EDIT ENTER**.
3. Select the desired data field option and press **EDIT ENTER**.

- **Restore Defaults?**— resets all data fields to the factory settings.
- **Setup Simulator?**— allows you to define speed, course and position values while in simulator mode. See the Getting Started tour for more on using simulator mode.

Sounder Page

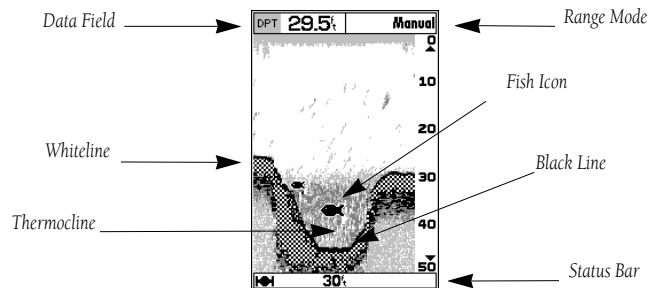

The **sounder page** is where your GPSMAP 135 Sounder becomes a powerful fishfinder. The top of the screen contains any of seven selectable data field options, while the middle of the page contains a right-to-left moving sonar image of the water beneath your boat. (Note: Items appear as they pass under your transducer. Those items on the right side of the screen are closer to you than those on the left.) **Fish** are displayed as a darkened arch or a fish icon in three different sizes. **Thermoclines** are shown as shades of gray.

The area of strongest sonar return (or **whiteline**) is displayed as a mix of light and dark checkering. Typically, the bottom will be the primary whiteline. A thin whiteline indicates a soft bottom while a thick whiteline shows a harder bottom. A **black line** is used to show the point where the water meets the whiteline. This black line will follow the contour of the bottom and show any objects of reasonable size. Along the right side of the screen is an **adjustable scale** which reflects the depth of the area being displayed. The **status bar** at the bottom of the page displays satellite signal status, digital depth, and any triggered alarms.

SOUNDER PAGE

Overview and Range Modes

SECTION 3

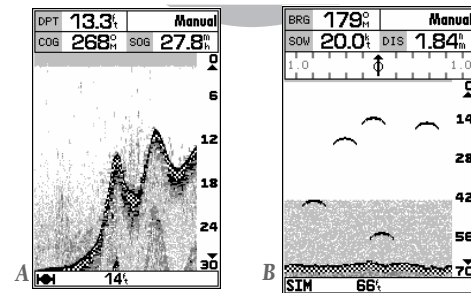

- A. The right side of the screen represents the transducer's location on your boat. Items appearing on the right side of the screen were passed by more recently than those on the left.
- B. The four-level gray LCD screen makes it possible to easily separate sonar targets from their surroundings.

SECTION 3

SOUNDER PAGE

Range Modes

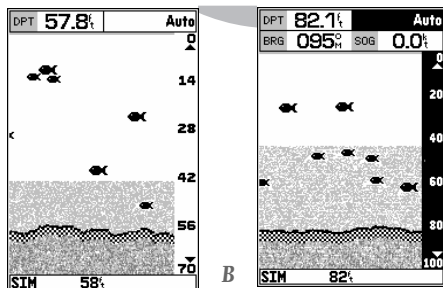

- A. Auto mode will show the most information available while always keeping the bottom in view.
- B. The range scale will be highlighted when using the arrow keypad to adjust manual range mode or when switching between auto and manual mode.



Range Modes

The GPSMAP 135 Sounder uses three depth range modes: auto, manual, and window. **Auto** is the default and continually adjusts the screen display to show the maximum amount of data possible, while always showing the bottom; **manual** allows you to adjust the sonar display's depth with the the  keypad; **window** lets you establish a starting depth (top) and length (span) for the sonar display.





Switching Between Ranges and Modes

The  keypad may be used for easy transition between manual and auto modes. Window mode, however, can only be activated from the sounder options menu (see page 31).



To switch from auto to manual mode:

1. Press the  keypad up or down until the desired depth range is displayed on the scale at the right side of the page.
2. Press  to confirm the selected range or  to return to Auto mode.

To adjust manual range or switch from manual to auto mode:

1. Press  keypad up or down until the desired depth range is displayed.
2. Press  to confirm the selected depth.
3. You can easily switch to Auto mode if you press and hold the  up or down until you hear a repeated beep. 'Auto' will be displayed in the function field at the top right corner of the page.
4. Press  to confirm.

To adjust the window range anytime after initial setup:

1. Press  once in any direction. The window range submenu will appear.
2. Enter values for the 'top' and 'span' fields and press .
3. When finished press .

Sounder Zoom Function

The sounder zoom function allows you to see the current display picture at 2 times (2X) and 4 times (4X) magnification. 2X means that the screen displayed will now cover 1/2 the depth you were originally viewing in twice the detail and 4X shows 1/4 the original depth at four times the detail. Because less area is being shown [in a zoom screen] objects can be seen in greater detail.



The sounder zoom function is accessed by using the  key when viewing the sounder page. The sounder zoom function is divided into four display levels:

- 2X Split Screen - Shows two reduced-size sonar pictures at the same time. The top half of the display screen will show the complete sonar picture at its original scale. The bottom half shows the original picture at 1/2 depth scale.
- 2X Full Screen - Displays the 2X zoomed picture on the full GPSMAP 135 Sounder screen and does not show the original scale picture.
- 4X Split Screen - Again shows two reduced pictures, with one showing the original scale and one at 1/4 the original depth scale.
- 4X Full Screen - Displays only the 4X zoomed picture on the full GPSMAP 135 Sounder screen.

Once activated, the zoomed picture replaces the sounder page display. Note: The zoom function can only be deactivated by using the  key and scrolling up to the original picture scale. **QUIT** will not turn off the zoom function.

The zoom function operates in either auto zoom or manual zoom. Auto zoom will follow the bottom contour while manual zoom will display the selected depth.

To activate the sounder zoom function:

1. While viewing the sounder page, press  down once. The 2X split screen will be displayed.
2. Continue to press  down to advance to further zoom screen levels.
3. To deactivate the zoom function, press  up until the original scale picture appears.

SOUNDER PAGE

Sounder Zoom

SECTION 3

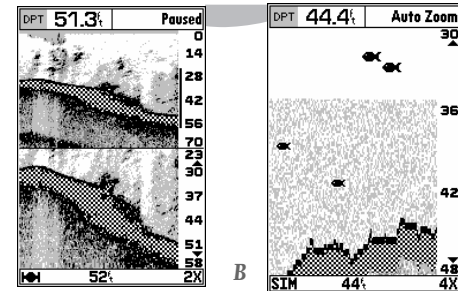

- A. The 2X zoom split screen allows you to view a smaller portion of the range while continuing to view the complete range.
- B. Use the 2X or 4X full screen zoom when you want to see the zoomed area displayed on the full screen.

SECTION 3

SOUNDER PAGE

Zoom Window

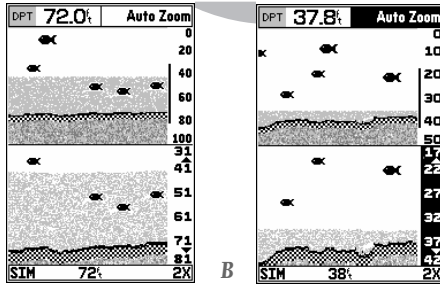

A

B

- A. Auto zoom will show the most information possible while continually showing the bottom on each half of the split screen.
- B. You can switch from manual to auto mode even while in the zoom mode, by pressing and holding the arrow keypad up or down until you hear a triple beep, and then pressing it once more.

Moving the Zoom Window

Once a zoom window has been activated, the zoom window can instantly be moved to show a different area. A zoom window indicator bar will be displayed on the right side of the original-scale picture (top). The bar's length and position will correspond to the zoomed picture displayed on the lower half of the screen.

To move the zoom window:

1. Press the keypad once in any direction to activate the movement function. The range scale on the right side of the zoomed picture will be highlighted.
2. Press the keypad up or right to move the window to view a shallower depth and down or left to view a deeper depth.
3. When the window reaches the desired position, press to accept or to return to the previous window position.

Underwater Waypoints

The underwater waypoint feature makes it possible to mark the position and depth of an object which you might want to return to, such as a stump, underwater ledge, etc. Note: Pressing QUIT returns you to the standard sounder screen.

To mark an underwater waypoint:

1. Press to pause the moving screen display.
2. Press the keypad in any direction to activate the on-screen cursor. A data field will appear with the cursor's depth, bearing and distance from your current position, and the waypoint's coordinates. Since the distance and bearing shown are measured from the boat to the waypoint, they will change as your boat moves, even if the cursor is stationary. Note: The cursor will not move off of the paused display and cannot show an area that has scrolled off the screen.
3. Use the keypad to move the cursor onto the target (stump, etc.) to be marked.
4. Press . A waypoint page will appear listing the waypoint's coordinates, default three digit name, and depth.

5. Enter any desired information for the waypoint such as name, comment, etc., and press **EDIT** **ENTER**.

6. To resume display movement, press **QUIT** or **EDIT** **ENTER**.

Note: In the event that you only want to find the depth of an object and not mark it as a waypoint, simply press **QUIT** once the depth has been displayed to return to normal operation.

Map/Sounder Page Split Screen

The GPSMAP 135 Sounder can be configured to display a split screen display of a sounder window and map page simultaneously to let you see cartography and sounder information at the same time. The split screen is activated from the **map** page only.

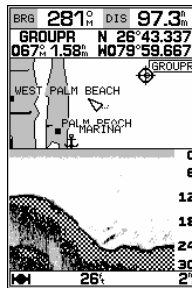
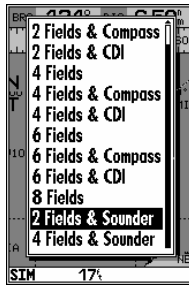

To select the map/sounder split screen display option:

1. Press the **MENU** key to display the map page options menu.
2. Highlight the 'Setup Page Display?' option and press **EDIT** **ENTER**.
3. Select either of the entries for "Fields & Sounder" and press **EDIT** **ENTER**.

The split screen map/sounder page functions as only a map page with sounder window for viewing only. To modify the sounder page, you must push **QUIT**, (to access the sounder page) make any desired changes, and then push **PAGE** to return to the map/sounder split screen. Note: For best results, it is recommended that you maximize the map portion of the sounder/map split screen. See page 40.

SOUNDER PAGE

SECTION

Underwater Waypoints and Map/Sounder Split Screen

3

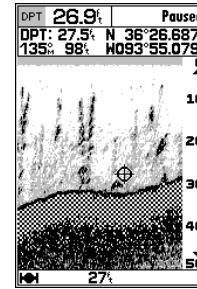

A

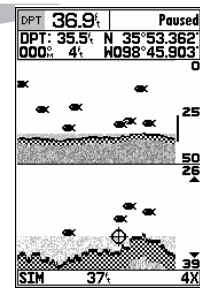

B

- A. Use the target cursor to mark an underwater waypoint and press **ENTER**.
- B. Underwater waypoints can be marked while using the zoom function by following the same steps used for a non-zoomed screen.

SECTION 3

SOUNDER PAGE Sounder Options

Sounder Page Options

The sounder options page lets you customize the sounder to your needs.

To display the sounder page options:

1. Press **MENU**.

The following options are available:

- **Sensitivity Adjust?**— determines how sensitive the sounder is to sonar echoes. High sensitivity may show clutter which can conceal fish, while low sensitivity may not show all fish.
- **Chart Speed Adjust?**— allows you to select the speed at which the sonar display scrolls across the screen.
- **Whiteline Adjust?**— enables you to select how the area of strongest sonar return is shown. A high setting will cause a thick whiteline while low settings show a thin whiteline.

To change the sensitivity, chart speed, or whiteline:

1. Highlight the specific option and press **EDIT ENTER**.
2. The operating display field in the upper right corner of the screen will be highlighted. Use the **⬇** keypad to select the desired value and press **EDIT ENTER**.

- **Set Range Mode?**— allows you to select from auto, manual, or window modes.

To set the range mode:

1. Highlight the 'Set Range Mode?' option and press **EDIT ENTER**.
2. Choose the desired mode and press **EDIT ENTER**. Nothing further is required to activate auto or manual modes. Window range mode, however, will require setup for first-time use or to change the existing window values.
3. Press the **⬆** keypad once in any direction to display a window range definition field. Enter a value for the TOP (depth at which the window will start) and the SPAN (length it will cover).
4. To finish press **QUIT**. Note: Previous window range values will be used whenever window range is activated unless changed from the window range definition field.

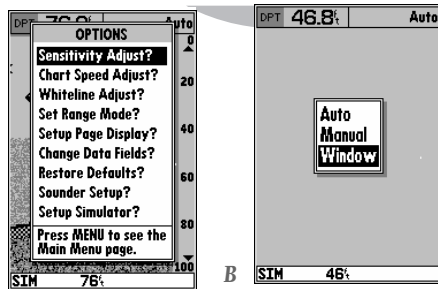

A

B

- A. Use the sounder options page to change the sounder page display to fit your needs.
- B. Three range modes may be selected.

• **Setup Page Display?**— allows you to select the fields displayed in the data section of the sounder page. The following options are available:

- 1 Field
- 1 Field & Compass
- 1 Field & CDI
- 3 Fields
- 3 Fields & Compass
- 3 Fields & CDI
- 5 Fields

To change the page display:

1. Highlight the 'Setup Page Display?' option and press **EDIT/ENTER**.
2. Highlight the desired field and press **EDIT/ENTER**.
3. Select a page display option and press **EDIT/ENTER**.

• **Change Data Fields?**— allows you to specify the data displayed in each data field used on the sounder page. The following options are available:

- BRG- bearing to active waypoint
- SOG- speed over ground
- ETE- estimated time enroute
- XTK- crosstrack error
- TRN- turn angle to waypoint
- DPT- depth
- STW- speed through water (transducer option)
- DIS- distance to active waypoint
- COG- course over ground
- ETA- estimated time of arrival
- VMG- velocity made good
- VDC- DC voltage
- TMP- temperature (transducer option)

To change a data field:

1. Highlight the 'Change Data Fields?' option and press **EDIT/ENTER**.
2. Move the field highlight to the desired field and press **EDIT/ENTER**.
3. Select a data field option and press **EDIT/ENTER**.
4. When finished press **QUIT**.

• **Restore Defaults?**— resets all sounder page options to the factory settings, except the sounder setup page options. Restoring defaults on the sounder setup page is addressed in the sounder setup page options menu (See page 35).

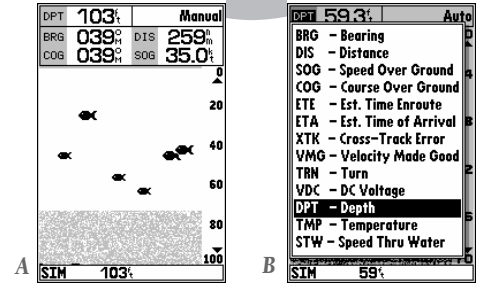

- A. The sounder page can be configured to display up to five data fields simultaneously.
- B. Any of thirteen information options may be shown in a designated data field.

SECTION 3

SOUNDER PAGE Sounder Setup



A

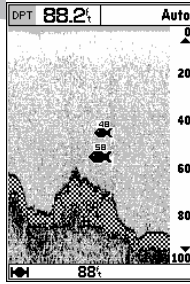

B

- A. The 'Off' fish id setting is the default setting and will display raw sonar data and show all targets as arches.
- B. The depth of each target is displayed by setting the 'TARGET DEPTH' field to 'On'.

Sounder Setup

The next sounder page menu option is 'Sounder Setup?'. This option allows you to setup the sounder for your specific needs. Five operational settings/functions may be accessed: fish ID, water type, noise rejection, keel offset, and speed calibration.

To access sounder setup:

1. Highlight the 'Sounder Setup?' option and press **EDIT ENTER**. The sounder setup page will appear.

- **Fish ID**— determines how the GPSMAP 135 Sounder identifies and labels sonar targets on the viewing screen. Three settings are available:
 - Off—is the default setting and shows all sonar target information as arches.
 - On—shows small, medium, or large fish icons in place of arches and displays other echo information (thermoclines, thin stumps, etc.) as shades of gray.
 - Fish Only—shows fish icons.

To select fish ID:

1. Highlight the 'Fish ID' option and press **EDIT ENTER**. The fish id submenu will appear.
2. Highlight the desired setting and press **EDIT ENTER**.

- **Target Depth**—Displays the digital depth of each fish icon.
 - On—shows fish icons with digital depth.
 - Off—does not display depth.

To select target depth:

1. Use the **ENTER** keypad to highlight the target depth field and press **EDIT ENTER**. A corresponding submenu will appear.
2. Highlight your submenu selection and press **EDIT ENTER**.



SOUNDER PAGE

Sounder Setup

SECTION 3



- **Water Type** - Maximizes the sounder's operation in cold, cool, or warm water and salt or freshwater. Has one field for water temperature and one for water composition. Set the water temperature option to 'Cold' if the water is below 40°F, 'Cool' if it is between 40°- 80°F, and 'Warm' if it is above 80°F. Set the water composition field to salt or freshwater depending on where you are fishing.

To select water temperature or composition:

1. Use the  keypad to select either the temperature or water composition field and press . A corresponding submenu will appear.
2. Highlight your submenu selection and press .



- **Noise Rejection** - Removes cross talk from other sounders or ignition noise due to poor boat motor installation (non-shielded plugs, etc.). The 'AUTO' setting is the default and identifies the presence of crosstalk noise, and turns rejection on when it needs to. When the noise disappears, it turns the rejection off. The 'OFF' setting prevents the unit from removing any perceived noise from the display. The 'ON' setting removes anything the unit thinks is cross talk noise and attempts to "repair" the damage done by suspected interference with real echoes.

To set noise rejection:

1. Highlight the "Noise Rejection" field and press . A submenu will appear.
2. Select from OFF, AUTO, or ON and press .

- **Keel Offset** - allows you to set the point from which the GPSMAP 135 Sounder will measure depth. This makes it possible to measure depth from the bottom of your keel instead of from the transducer's location. A positive number will measure depth from a deeper point while a negative number reflects a shallower point.

To set keel offset:

1. Highlight the "Keel Offset" field and press . Use the  to enter the keel offset value and press .

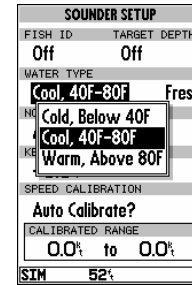

A

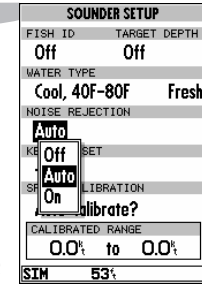

B

- A. The correct temperature setting will ensure that the sounder gives more accurate depth measurements.
- B. Use the noise rejection feature to minimize interference from nearby electronics.

SECTION 3 SOUNDER PAGE

3 Sounder Setup and Calibration

SOUNDER SETUP	
FISH ID	TARGET DEPTH
Off	Off
WATER TYPE	
Cool, 40F-80F	Fresh
NOISE REJECTION	
Auto	
KEEL OFFSET	
+0.0'	
SPEED CALIBRATION	
Auto Calibrate?	
CALIBRATED RANGE	
0.0'	to 0.0'
SIM 53%	

AUTO CALIBRATION	
INSTRUCTIONS	
Speed over water will be calibrated using GPS speed over ground as the basis. Therefore calibration should take place in water having little or no current.	
GPS - SOG	
0.0'	
SOG	CR
0.0'	0%
Press ENTER to Start	
SIM 66%	

A

B

- Calibration is required to use the GPSMAP 135 Sounder with a transducer equipped for accurate speed through water readings.
- Follow instructions for auto calibration carefully.

- Speed Calibration - If you are using a transducer equipped to display speed through water (STW)**, calibration is required to ensure that the STW displayed by your GPSMAP 135 Sounder will be accurate. The unit may be calibrated automatically or manually, but auto calibration is recommended and is the default setting.

To calibrate the unit:

- Press the **MENU** key to display the sounder options page.
- Using the **⬇** keypad, highlight 'Sounder Setup?' and press **EDIT ENTER**.
- Choose between auto and manual calibration.

To use Auto Calibration:

- Ensure 'Auto Calibrate?' is displayed in the speed calibration field. If it is not, press **MENU** to display the calibration menu.
- Highlight 'Auto Calibrate' and press **EDIT ENTER**.
- Press **EDIT ENTER** again and an instruction message will appear.
- After reading the instructions, and when you are ready to begin the calibration, press **EDIT ENTER**.
- Slowly accelerate your boat to a maximum safe cruising speed and then back down to a stop and press **EDIT ENTER**. The minimum and maximum speed which the unit is now calibrated for will be displayed in the 'calibrated range' field.
- Auto calibration is complete.

When **manual calibration** mode is selected, the speed calibration bar will appear as a white horizontal strip, with a black slider bar positioned in the middle.

Before entering the calibration, you will need to compare the value shown on the speed calibration field's STW display, with your boat's actual speed as determined by the speedometer or by using a stop watch. Accelerate to a safe speed and compare the two speed readings.

To use Manual Calibration:

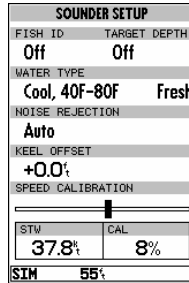
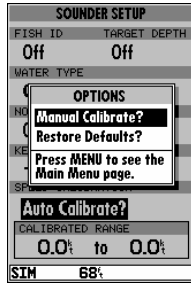

1. Ensure manual calibration mode is selected in the speed calibration field, if not, press **MENU**, highlight 'Manual Calibrate?', and press **MENU**.
2. Press **EDIT/ENTER**. The slider bar will turn black and the calibration range bar will turn to white.
3. Use the **0** keypad to move the selector bar until the speed displayed in the 'STW' field matches the speed of your boat. Move the bar to the left for negative values and right for positive values.
4. When the desired speed is displayed, press **EDIT/ENTER**.
5. Press **QUIT** to return to the sounder page.

Two options may be accessed from the sounder setup options menu: 'Manual or Auto Calibration' (whichever one currently is not selected) and 'Restore Defaults'. Access the options menu by pressing **MENU**, select an option, and press **EDIT/ENTER**.

- **Setup Simulator?**— This sounder page option will appear only when the unit is in simulator mode. It allows you to define simulator speed, course, altitude, depth, and position values. See the Getting Started Tour for more on the simulator.

SOUNDER PAGE

Sounder Setup and Calibration

SECTION 3

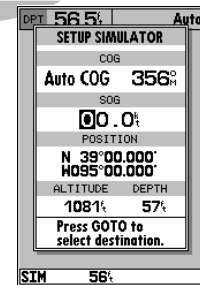
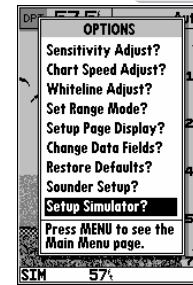

- A. The 'Setup Simulator?' option is included in the options menu for each of the five main pages when in simulator mode.
- B. Each simulator data field may be modified to display user-selected values and navigational information.

SECTION 4

MAP PAGE Overview

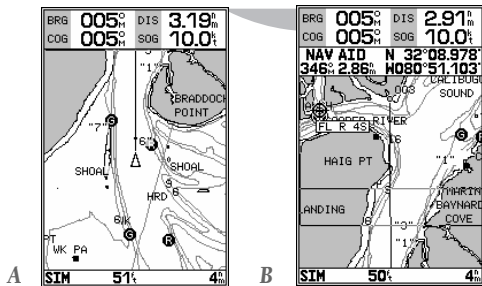

- A. Use the cursor to pan ahead to other map areas. The map display will automatically scroll forward when you reach the edge of the map.
- B. To select or 'highlight' an on-screen navaid or waypoint, simply move the cursor over the waypoint symbol. The cursor will 'snap' to the waypoint, and display its name and position in the data field.

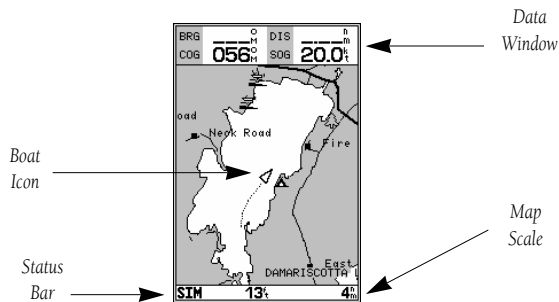

Map Page



The GPSMAP 135 Sounder's map page provides a comprehensive display of electronic cartography, plotting and navigational data. The **map display** shows your boat on a digital chart, complete with geographic names, navaids, depth contours and a host of other chart features. It also plots your track and displays any routes and waypoints you create. An on-screen cursor lets you pan and scroll to other map areas, determine the distance and bearing to a position, and perform various route and waypoint functions.

The **data window**, located at the top of the page, provides a user-selectable display of your current course and speed over ground, along with the bearing and distance to a destination waypoint. Whenever the cursor is active, an additional data window will appear below to indicate the position, range and bearing to the cursor or a selected waypoint or navaid. Each data field may be configured to display any one of thirteen data options. The data window may also be changed to display additional data fields, a compass tape, or a CDI scale. The **status bar** at the bottom of the page displays the map scale currently in use.

Map Modes

The map display uses the cursor keypad and a set of hard keys to control most map display functions. The  keys, combined with the  keypad, let you select zoom ranges and move the cursor. Two basic map operating modes, position mode and cursor mode, determine what cartography is shown on the map display. Position mode pans the cartography to keep the present position marker within the display area, while cursor mode pans the cartography to keep the cursor within the display area.

The GPSMAP system will always power up in the position mode, with your vessel centered on the map display.

- Whenever sufficient map coverage is not available to keep the boat centered, the boat icon will move toward the edge of the display.
- If the boat icon attempts to go off the display, the zoom level may need to be adjusted to keep cartography on screen.

Whenever the  keypad is pressed, the GPSMAP 135 Sounder will enter cursor mode. In cursor mode:

- The cursor can be moved over the map display using the  keypad.
- Whenever the cursor reaches the edge of the display, the map will scroll forward under the cursor. Keep in mind that the boat icon will move with the map scrolling and may go off the display screen (you may not be able to see your present position).
- When the cursor is stationary, a fixed coordinate position will appear in the position field. Note that the distance and bearing will change as the boat's position changes.
- Whenever you zoom in cursor mode, the cursor will be centered on screen.
- To return to position mode, press the **QUIT** key.

MAP PAGE

Map Modes

SECTION 4

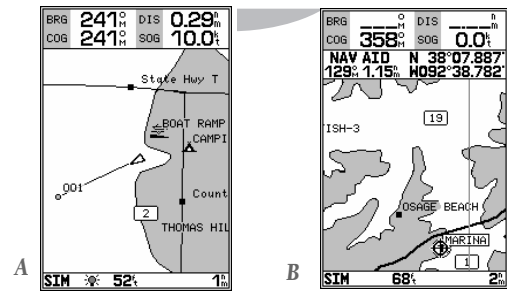

A. Position mode on inland water cartography.

B. Cursor mode on inland water cartography.

SECTION 4

MAP PAGE Using the Cursor

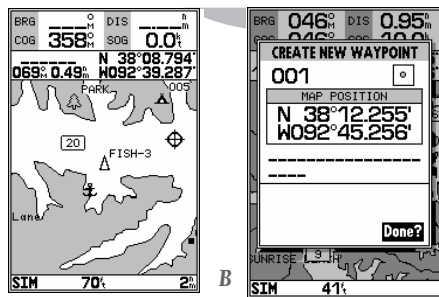

A

B

- A.** To create a new waypoint at the cursor, move the cursor to the desired position and press EDIT/ENTER.
- B.** The create new waypoint page will appear, where you may change the waypoint name, symbol and comment before saving the waypoint.

Using the Cursor

The cursor allows you to pan away from your present position and scroll to other map areas around the world (even outside of your current G-chart coverage). As you pan past the edge of the current map display, the screen will actively scroll forward to provide continuous map coverage.

To move the cursor:

1. Press the keypad to move the cursor in an up, down, left or right direction.

As you move the cursor, the distance and bearing from your present position to the cursor will be displayed in the data window, along with the cursor's position coordinates. Keep in mind that when the cursor is stationary, the distance and bearing from your present position will change as your boat moves. The cursor may also be used to 'snap' to on-screen waypoints and nav aids, allowing you to review a selected position directly from the map display.

To select an on-screen waypoint or nav aid with the cursor:

1. Use the keypad to move the cursor to the desired waypoint or nav aid (if there are several waypoints grouped closely together, zoom in closer for a better view).
2. When a waypoint or nav aid is selected, it will become highlighted on screen, with the name and position displayed.

To eliminate the cursor and re-center your position on-screen:

1. Press the key.

The cursor may also be used to create new waypoints directly from the map.



To create a waypoint with the cursor:

1. Use the keypad to move the cursor to the desired map position.
2. Press .
3. Press to confirm the new waypoint using the default three-digit name.

Selecting Map Scales

The map display has 16 available range scales from 1/8th to 4096 n.m. (1/4 to 7500km). The map scale is controlled by the  keys, with the current scale displayed at the bottom of the data window.

To select a map scale:

1. Press the up  key to zoom out and the down  key to zoom in.

The GPSMAP 135 Sounder's system has a built-in worldwide database to 64 n.m.(see Appendix D for a built-in coverage map), with more detailed coverage available through the use of G-chart™ data cartridges (see pages 80-81 for installing and using G-chart™ cartridges). The GPSMAP 135 Sounder will display cartography as long as there is chart information available for the range you've selected. Map coverage will conform to the following conditions:

- When the selected zoom range is covered by either the internal database or a G-chart data cartridge, cartography will be displayed.
- When the selected zoom range is covered by both the internal database and a G-chart cartridge, cartography will be displayed using the data with the best resolution.
- When the selected zoom range exceeds the resolution of the chart in use by up to two settings, overzoom cartography will be displayed. The display will not show any filled landmass areas, and an 'Ovr Zm' warning will appear in the scale field. The lat/lon grid will also be turned on regardless of the map configuration setting.
- When the selected zoom range exceeds the resolution of the chart in use by more than two settings, all cartography will be replaced by a track plot display, and a 'No Map' warning will appear in the scale field. The lat/lon grid will be displayed regardless of the map configuration setting. Additional caution should be used while navigating in track plot mode.

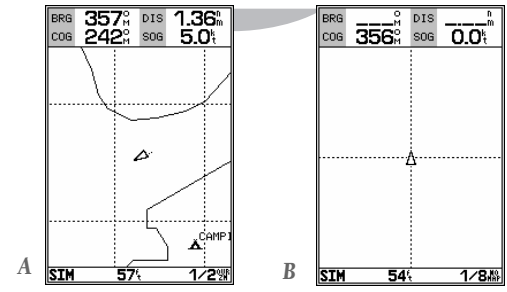
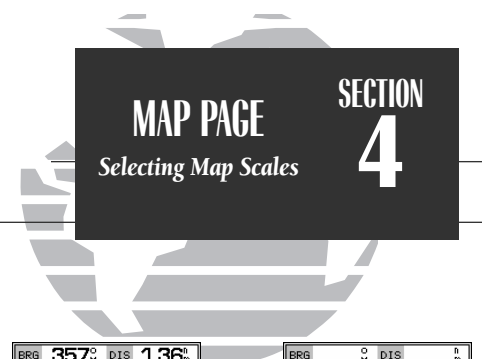

- A. Whenever the selected map scale exceeds the resolution of the chart by up to two settings, an 'Ovr Zm' warning will appear in the scale field.
- B. Whenever the selected map scale exceeds the resolution of the chart by more than two settings, a 'No Map' warning will appear in the scale field.

SECTION

4

MAP PAGE

Map Page Options

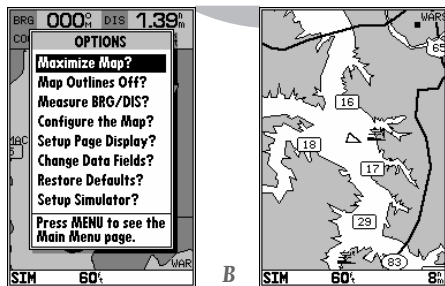

A. The map options page provides access to all map configuration, page display and data field options.

B. The 'Maximize Map?' option will eliminate the data fields and show full-screen cartography.

Map Page Options

The GPSMAP 135 Sounder map page is designed to be a flexible tool that can be custom-tailored to your exact navigation needs. The map options page provides access to many of the features and functions that will help you configure the map page to your own preferences.

To display the map page options:

1. Press **MENU**.

To select a menu option:

1. Highlight the desired option and press **EDIT ENTER**.

The following options are available:

- **Maximize/Normal Map?**— allows you to select between a full-screen map display or the default map display with data window.
- **Map Outlines Off/On?**— allows you to specify whether coverage outlines for G-chart cartography are displayed or not. The default setting is on.
- **Measure BRG/DIS?**— allows you to measure the bearing and distance between any two points on the map display.

To measure the BRG/DIS between two points:

1. Highlight the 'Measure BRG/DIS?' option and press **EDIT ENTER**. An on-screen pointer will appear on the map display at your present position.
2. Move the cursor to the desired reference point (the point that you want to measure from) and press **EDIT ENTER**.
3. Move the cursor to the point that you want to measure to. The bearing and distance from the reference point will be displayed at the bottom left of the data window.
4. Press the **QUIT** key to finish.

- **Configure the Map?**— allows you to determine what chart features are displayed on a particular map scale to prevent excessive clutter. The map configuration page features an on/off grid with a list of chart features down the left side. The zoom scales are displayed across the top of the grid with the chart scale currently in use also indicated. The far-left scale setting represents all map scales 64 nm and above. A check mark in a grid box indicates that the chart feature listed will be displayed at the corresponding scale.

Individual grid boxes may be turned on and off through a popup scale window, while entire rows may be controlled by using the map configuration options page (accessible through the **MENU** key).

To use the map configuration grid:

1. Use the **0** keypad to select the desired map item and press **EDIT/ENTER**.
A popup window will appear with the current settings displayed.
2. Use the **0** keypad to highlight the scale you want to change.
3. Press **EDIT/ENTER** to change the on/off setting.
4. Press **QUIT** to finish.

To turn an entire row on or off:

1. Use the **0** keypad to select the desired map item.
2. Press the **MENU** key.
3. Select the 'Enable Row?' or 'Disable Row?' option and press **EDIT/ENTER**.

The map configuration page also allows you to set the moving map display to a North Up, Track Up or Desired Track Up orientation.

To change the map orientation:

1. Use the **0** keypad to highlight the 'Orientation' field and press **EDIT/ENTER**.
2. Select the desired setting and press **EDIT/ENTER**.

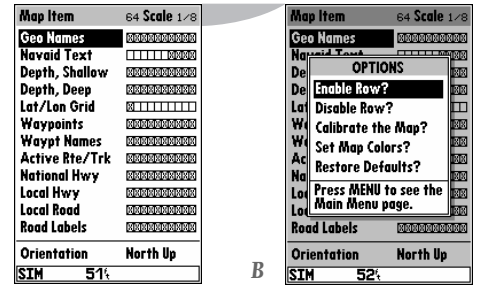
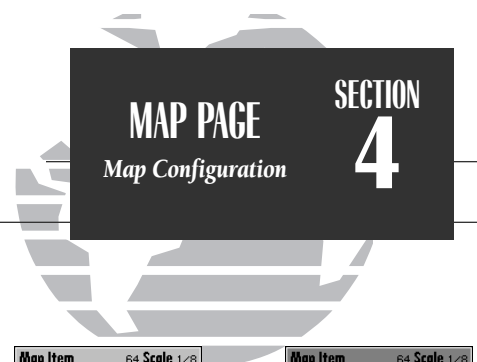

- A. The map configuration grid allows you to define what items appear on the display at each map scale.
- B. To turn an entire row on for the selected map item, highlight the 'Enable Row?' option and press **EDIT/ENTER**.

SECTION 4

MAP PAGE

Map Configuration & Map Colors

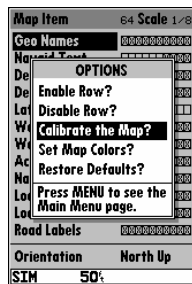

A

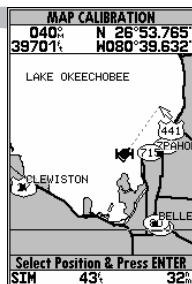

B

- A. To calibrate the map, highlight the 'Calibrate the Map?' option and press EDIT/ENTER.
- B. A satellite icon will remain on the map to indicate the GPS position, while the boat marker will reflect the calibration changes.

CAUTION!

The map calibration function should never be used to attempt corrections to Selective Availability errors.

The map configuration options page also features a map calibration function that allows you to calibrate the map display with your exact physical surroundings or correct data from older charts. Before using the map calibration function, check to make sure that your map datum selected on the GPS matches the datum on the chart you are using (see page 76). To calibrate the map display, you must know exactly where you are, and understand that the correction is generally valid only in a limited range from the point of correction.

Map calibration should only be performed while the vessel is not moving, and should never be used to attempt SA corrections, which can degrade accuracy up to 330' (100 meters). The maximum correction is 16,400 feet (5000m).

To calibrate the map:

1. Select the 'Calibrate the Map?' option and press **EDIT/ENTER**.
2. Use the **⬇** keypad to move the arrow cursor from the satellite position (indicated by the satellite icon) to your exact position. The bearing, distance and position will be indicated in the data window.
3. Press **EDIT/ENTER** to confirm the calibration offset.

The next option available from the map configuration page is the set map colors option, which allows you to define the fill color (grayscale) of the land and water used on the map display. Three options are available: no color (no fills for land or water), gray land/white water (the default setting), and white land/gray water.

To select a map colors option:

1. Select the 'Set Map Colors?' option and press **EDIT/ENTER**.
2. Highlight the desired map color option and press **EDIT/ENTER**.

The map configuration options page also features a 'restore defaults' function that can be used to quickly restore all map configuration options to the factory settings.

To restore the map configuration options to the factory defaults:

1. Highlight the 'Restore Defaults?' settings and press **EDIT/ENTER**.

- **Setup Page Display?**— allows you to specify the fields displayed in the data window section of the map page by selecting one of the following display options:

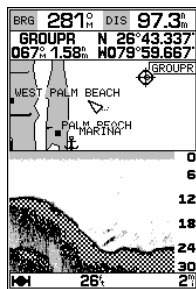
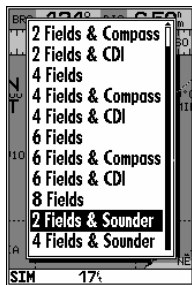

Note: The last two display options make it possible to display both the map page and sounder page simultaneously as a split screen. The top half of the page will show a reduced-size map page while the sounder page be displayed in the lower half of the screen. The sounder page portion of the split screen is only for viewing and cannot be accessed in this mode. To modify or access the sounder page display, press **QUIT** or **PAGE** until the actual sounder page appears, make any desired changes, and then return to the split screen map page.

- | | |
|----------------------|----------------------|
| • 2 Fields | • 2 Fields & Compass |
| • 2 Fields & CDI | • 4 Fields |
| • 4 Fields & Compass | • 4 Fields & CDI |
| • 6 Fields | • 6 Fields & Compass |
| • 6 Fields & CDI | • 8 Fields |
| • 2 Fields & Sounder | • 4 Fields & Sounder |

To select a page display option:

1. Highlight the 'Setup Page Display?' option and press **EDIT ENTER**.
2. Select the desired option and press **EDIT ENTER**.

MAP PAGE SECTION 4

Page Display & Data Fields

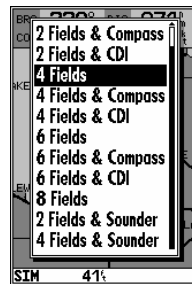

A

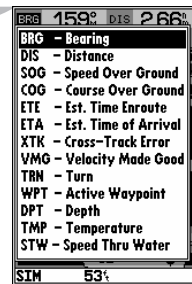

B

- A. The map page can be configured to display a variety of navigation data.
- B. Each data field can be set to display one of 13 data options.

SECTION



4

MAP PAGE

Options

- **Change Data Fields?**— allows you to specify the data displayed in each data field used on the map display. The following options are available:
 - BRG- bearing to active wpt
 - SOG- speed over ground
 - ETE- estimated time enroute
 - XTK- crosstrack error
 - TRN- turn angle to wpt
 - DPT- depth
 - STW- speed through water
 - DIS- distance to active wpt
 - COG- course over ground
 - ETA- estimated time of arrival
 - VMG- velocity made good
 - WPT- active wpt name
 - TMP- temperature

To change a data field:

1. Highlight the 'Change Data Fields?' option and press .
2. Move the field highlight to the desired field and press .
3. Select a data field option and press .

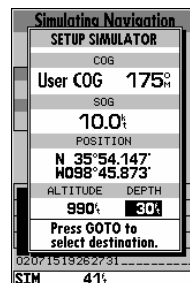
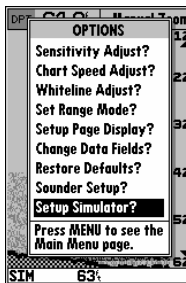

- **Restore Defaults?**— resets all map page options (except map configuration options, see pages 41-42) to the factory settings.
- **Setup Simulator?**— allows you to define simulator speed, course, altitude, depth, and position values.

See the Getting Started Tour for more on the simulator mode.

GPSMAP 135 Sounder Navigation Page

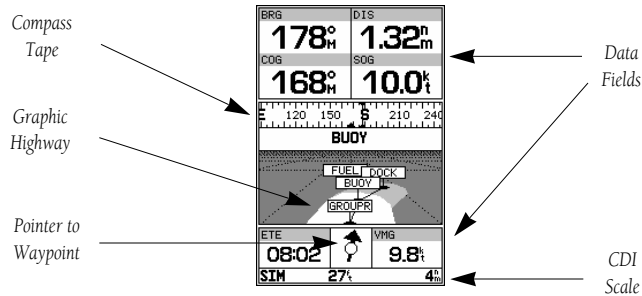

Whenever a GOTO, MOB, TracBack or route has been activated, the GPSMAP 135 Sounder will provide digital and graphic steering guidance to the destination with the navigation page. The top half of the nav page features four user-selectable **data fields** that display the bearing (BRG) and distance (DIS) to waypoint, along with your current course (COG) and speed over ground (SOG). In addition, there is a moving compass tape to indicate the direction you're heading. Two additional data fields at the bottom of the page show the estimated time enroute (ETE) and velocity made good (VMG) to your destination.

The middle section of the screen provides visual guidance to the waypoint on a **graphic highway** display. The line down the center of the highway represents your desired track, while a graphic indication of the distance and direction you are off course is shown on a scale at the bottom right of the page (the selected scale represents the distance from side to side). The **arrow pointer** below the highway always points to the destination waypoint relative to the direction you are moving.

NAVIGATION PAGE SECTION 5

Overview

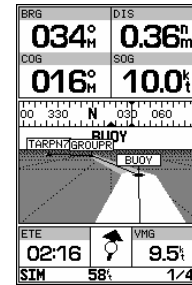

The navigation page can be configured to show the active waypoint, all route waypoints and/or nearby waypoints on the graphic highway.

SECTION NAVIGATION PAGE

5

Highway Scale & Nav Page Options

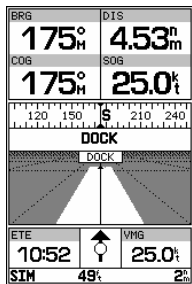

A



B

- To change the highway scale perspective, press the ZOOM keys.
- The navigation options page lets you set up the navigation page to your own preferences.



As you head toward your destination, the highway perspective will move to indicate your progress to the waypoint and which direction you should steer to stay on course. If you are navigating a route, the navigation page will show each route waypoint in sequence, with the active leg indicated by the white portion of the highway. Nearby waypoints not in the active route will also be displayed. The highway perspective scale may also be zoomed in or out to display a larger or smaller view of the highway. Five settings are available from 1/4 to 4 nm, with a default setting of 1/4 nm.

To change the highway perspective scale:

- Press the up or down arrow of the key to select the desired setting.

Navigation Page Options

The GPSMAP 135 Sounder's navigation options page allows you to define the nav data fields and select what waypoints are displayed on screen.

To display the navigation page options:

- Press .

To select a menu option:

- Highlight the desired option and press .

The following options are available for the navigation page:

- **Change Data Fields?**— allows you to define the data displayed in any of the six user-selectable data fields. Thirteen data options are available:
 - BRG
 - SOG
 - ETE
 - XTK
 - CTS
 - DIS
 - COG
 - ETA
 - VMG
 - DPT
 - STW
 - TMP
 - TRN

To change a data field:

1. Highlight the 'Change Data Fields?' option and press **EDIT/ENTER**.
2. Highlight the field you want to change and press **EDIT/ENTER**.
3. Select the desired data field option and press **EDIT/ENTER**.

- **Configure Highway?**— allows you to select what waypoints are shown on the highway display. Four options are available:

- Nav & Nearest Waypoints— all route and nearest waypoints displayed
- Nav Waypoints— only waypoints in the active route will be displayed
- Active Waypoint— only the active waypoint will be displayed
- No Waypoints— no waypoints will be displayed

To configure the highway display:

1. Highlight the 'Configure Highway?' option and press **EDIT/ENTER**.
2. Select the desired option and press **EDIT/ENTER**.

- **Restore Defaults?**— resets all navigation page options to the factory settings.
- **Setup Simulator?**— allows you to define simulator speed, course, altitude, depth, and position values . See pages 4-19 for more details on using simulator mode.
- **Auto COG?**— allows you to reset automatic steering while simulating navigation and cancel any course adjustments made with the **⏪** keypad.

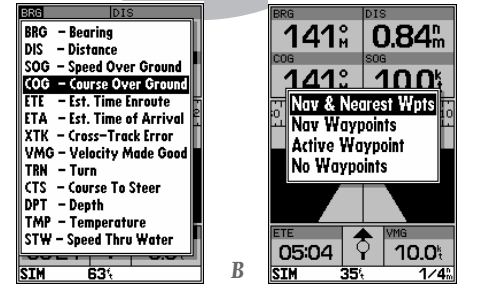

A. Thirteen data options are available for each data field on the navigation page. The digital crosstrack error option is especially useful to display the exact distance you are off course in feet/miles or meters.

B. To select what waypoints appear on the graphic highway, highlight the desired setting and press EDIT/ENTER.

SECTION 6 MAIN MENU PAGE

Overview

MAIN MENU
Nearest Waypoints
Proximity Waypoints
Create Waypoint
Waypoints
Routes
Track
Trip & Fuel Planning
System Setup
Navigation Setup
Timers & Alarms
Input/Output
SIM 25%

MAIN MENU
Nearest Waypoints
Proximity Waypoints
Create Waypoint
Waypoints
Routes
Track
Trip & Fuel Planning
System Setup
Navigation Setup
Timers & Alarms
Input/Output
SIM 23%

A

B

- A. The waypoint category options on the main menu page are described in the Waypoints section on pages 55-59.
- B. The routes category options are described on pages 62-69.

Main Menu Page

The GPSMAP 135 Sounder's main menu page provides access to various waypoint, system, navigation and interface management and setup menus. The main menu page is available from any page in the GPSMAP 135 Sounder's system, and is accessed through the **MENU** key.

MAIN MENU
Nearest Waypoints
Proximity Waypoints
Create Waypoint
Waypoints
Routes
Track
Trip & Fuel Planning
System Setup
Navigation Setup
Timers & Alarms
Input/Output
SIM 18%

To access the main menu page:

1. Press **MENU** twice.

The 11 submenus are divided into categories by function.

To select a submenu from the main menu page:

1. Highlight the submenu you want to view and press **EDIT/ENTER**.

For specific instructions on using a submenu, see the waypoints, route or setup sections of this manual.

Creating and Using Waypoints

The GARMIN GPSMAP 135 Sounder stores up to 250 alphanumeric waypoints with a user-defined icon and comment available for each waypoint. Waypoints can be created using three basic methods:

- **MARK key**— used primarily for marking your present position, the **MARK** key also provides options that allow you to select a map or navaid position from the map display.
- **Graphically**— allows you to define a new waypoint position from the map or sounder display using the cursor.
- **Text Entry**— allows you to enter a new waypoint's position coordinates manually (from a chart, etc.) or by referencing it's bearing and distance from a stored waypoint or your present position.

Mark Key

The GARMIN GPSMAP 135 Sounder's **MARK** key lets you quickly capture your present position— or cursor or navaid position— in order to create a new waypoint. You must have a valid position fix to mark your present position.

To mark your present position:

1. Press the **MARK** key. The mark position page will appear, with a default three-digit name for the new waypoint.
2. To accept the waypoint with the default name, symbol and comment (the depth at the waypoint's position), press **EDIT/ENTER** to confirm the 'Done?' prompt.
3. To enter a different name, symbol or comment, highlight the appropriate field and press the **EDIT/ENTER** key.
4. After entering and confirming your changes, move the field highlight back to the 'Done?' prompt and press **EDIT/ENTER**.

WAYPOINTS

SECTION

7

Creating Waypoints & MARK Key

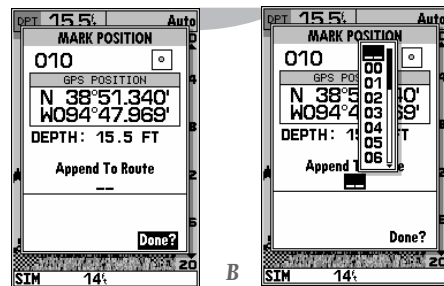

A

B

- A. The mark key is used primarily to mark your present position, but it can also be used to mark the cursor or a navaid position from the map page.
- B. The mark position page also allows you to add the new waypoint to the end of any route. If you're heading out without a planned route, you can create a series of waypoints along the way with the mark key and save them to an open storage route. When you're ready to head back, simply invert the route to get back (see page 66).

SECTION 7

WAYPOINTS

Using the MARK Key

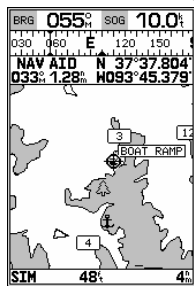

A



B

- A. To create a waypoint at an on-screen navaid, move the cursor over the desired navaid.
- B. Press the MARK key and select the 'Use Navaid Posn?' option. Press EDIT/ENTER to finish.

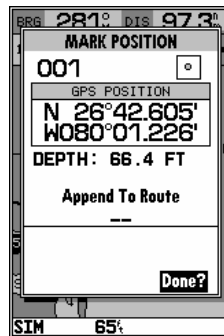

The mark key may also be used on the map page to mark the cursor position or an on-screen navaid. To mark a navaid, select the desired navaid with the cursor. The GPSMAP 135 Sounder will use the navaid text shown on the cartography as the default comment.





To mark the cursor or navaid position with the **MARK** key:

1. Use the **⬅** keypad to move the cursor to the desired position or navaid.
2. Press the **MARK** key.
3. Highlight the 'Use Map Posn?' or the 'Use NAVAID Posn?' option and press **EDIT/ENTER**.
4. To accept the waypoint with the default name, symbol and comment (the depth at that position), press **EDIT/ENTER**.
5. To enter a different name, symbol or comment, highlight the appropriate field and press the **EDIT/ENTER** key.
6. After entering and confirming your changes, move the field highlight back to the 'Done?' prompt and press **EDIT/ENTER**.

Creating Waypoints Graphically

Waypoints may also be quickly created from the map display, which allows you to 'point and shoot' at any map position to create a new waypoint.







To create a new waypoint graphically:

1. Use the  keypad to move the cursor to the desired map position. If you want to create the new waypoint at an on-screen navaid, highlight the navaid on the map display.
2. Press .
3. To accept the waypoint with the default name, symbol and comment, press . If you are creating a waypoint at an on-screen navaid, the default symbol and comment will automatically reflect the selected navaid's name and symbol.
4. To change the name, symbol or comment, highlight the appropriate field and press .
5. After entering and confirming your changes, move the field highlight back to the 'Done?' prompt and press .

Creating Waypoints By Text Entry

Waypoints may also be created by manually entering a position's coordinates or referencing a stored waypoint through the 'Create Waypoint' submenu option on the main menu page.

To create a new waypoint by manually entering its coordinates:

1. Press  twice to display the main menu page.
2. Highlight the 'Create Waypoint' option and press . The waypoint definition page will appear, with the next available waypoint number and the receiver's last known position as the default name and position.
3. Use the  keypad to enter the new waypoint name, icon, position, and comment. Press  after the last character in each section.
4. When you have finished entering all your waypoint data, use the  keypad to highlight the 'Done?' prompt and press .

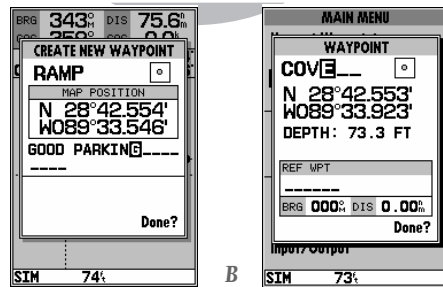
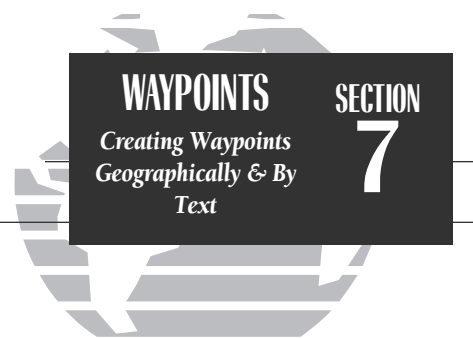

A

B

- A. Once a position has been selected graphically, the create new waypoint page will appear. Here you can change the waypoint name, symbol or comment before saving the waypoint.
- B. To create a waypoint by text entry, start by entering the new waypoint's name.

SECTION 7

WAYPOINTS

Creating a Waypoint by Reference

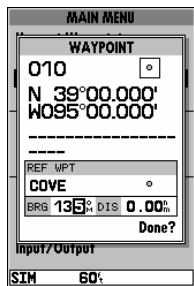

A

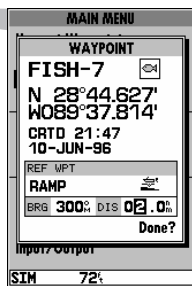

B

- A. Enter the bearing from the reference waypoint to the new waypoint in the 'BRG' field.
- B. Enter the distance from the reference waypoint to the new waypoint in the 'DIS' field.

Reference Waypoints

A new waypoint may also be created without knowing position coordinates by entering its range and bearing from an existing waypoint or your present position. The GPSMAP 135 Sounder will then calculate the position coordinates for you, using the reference selected.

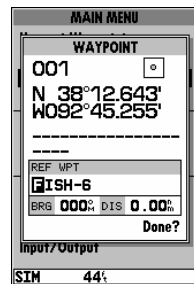

To create a new waypoint using a reference waypoint:

1. Select the 'Create Waypoint' option from the main menu page and press **EDIT ENTER**.
2. Enter the name, icon, and comment, for the new waypoint.
3. Highlight the reference waypoint field and press **EDIT ENTER**.
4. Enter the name of the reference waypoint using the **0** keypad, or press **MENU** to select the waypoint from the nearest list, waypoint list, or map display. Leave the reference field blank to use your present position.
5. Press **EDIT ENTER** to begin entry of the bearing from your reference waypoint to the new waypoint position. Enter the bearing and press **EDIT ENTER**.
6. Press **EDIT ENTER** to begin entry of the distance from your reference waypoint to the new waypoint position. Enter the distance and press **EDIT ENTER**. The position for the new waypoint will automatically be calculated.
7. Highlight the 'Done' prompt and press **EDIT ENTER** to finish.

Reviewing & Editing Waypoints

Once you have created and stored a waypoint, it may be modified, reviewed, renamed or deleted at any time through the waypoint definition page. The waypoint definition page is available for any stored waypoint by highlighting the desired waypoint from the map display or selecting it from waypoint or nearest waypoint lists and pressing the **EDIT ENTER** key once. The waypoint definition page can also be accessed from the proximity waypoint page by highlighting the desired waypoint and pressing **EDIT ENTER** twice.

To access the waypoint definition page:

1. Use the **▲** keypad to highlight the desired waypoint on the map display (or any waypoint list).
2. Press **EDIT ENTER** to display the waypoint definition page.

From the waypoint definition page, you may change the waypoint symbol, position coordinates, waypoint comment, or depth for the selected waypoint.

To change the waypoint symbol:

1. Highlight the waypoint symbol field and press **EDIT ENTER**.
2. Use the **▲** keypad to select the desired symbol and press **EDIT ENTER** to confirm.

To change the position coordinates:

1. Highlight the coordinates field and press **EDIT ENTER**.
2. Use the **▲** keypad to edit the coordinates and press **EDIT ENTER** to confirm.

To change the waypoint comment:

1. Highlight the comment field and press **EDIT ENTER**.
2. Use the LEFT arrow of the **▲** keypad to clear the comment field.
3. Use the **▲** keypad to enter a comment (up to 16 characters).
4. Press **EDIT ENTER** to confirm.

WAYPOINTS

Reviewing & Editing
Waypoints

SECTION 7

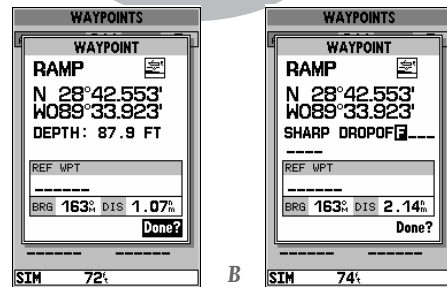

- A. The waypoint definition page will appear whenever a waypoint is selected from the map or a waypoint list.
- B. A 20-character custom comment may be assigned to every waypoint. The default comment is the depth at the waypoint's position for waypoints marked with the MARK button and underwater waypoints. For all other waypoints (those created with the ENTER button), the current date will be the default comment.

SECTION 7

WAYPOINTS

Waypoint Definition Page Options



A



B

- A. To review or edit a waypoint on the map display, select the 'Edit Wpt On Map?' option.
- B. To move the selected waypoint, press **EDIT/ENTER**. Use the arrow keypad to select the new position, and press **EDIT/ENTER** to finish.

Waypoint Definition Page Options

The waypoint definition page also features an options page that allows you to edit the selected waypoint on the map display, rename the selected waypoint or delete the waypoint from memory.

To display the waypoint definition page options:

1. Press the **MENU** key.

To review/edit the selected waypoint from the map display:

1. Highlight the 'Edit Wpt On Map?' option and press **EDIT/ENTER**.
2. The selected waypoint will appear on the map display, with the waypoint name and coordinates shown at the top of the map, along with the distance and bearing to the waypoint from your present position.
3. To move the selected waypoint's position, press **EDIT/ENTER**. A 'MOVE' label will now appear under the cursor arrow.
4. Use the **▲** keypad to move the cursor arrow to the desired position. The cursor's coordinates, along with the distance and bearing from the waypoint's position, will be displayed at the top of the map display.
5. Press **EDIT/ENTER** to set the waypoint's new position, and **QUIT** to return to the waypoint definition page.

To rename the selected waypoint:

1. Highlight the 'Rename Waypoint?' option and press **EDIT/ENTER**.
2. Enter the new waypoint name and press **EDIT/ENTER**.
3. Press **EDIT/ENTER** to confirm the 'Yes' prompt.

To delete the selected waypoint:

1. Highlight the 'Delete Waypoint?' option and press **EDIT/ENTER**.
2. Press **EDIT/ENTER** to confirm.

Waypoint Submenus

The GPSMAP 135 Sounder's main menu page features four waypoint submenu that let you manage a large number of waypoints quickly and efficiently. The submenus also provide a continuously updated nearest waypoints list and a proximity waypoint alarm function that can be used to define an alarm circle around submerged hazards, shallow waters, etc.

To access the main menu page/waypoint submenus:

1. Press **MENU** twice.

The first waypoint submenu is the **nearest waypoints list**, which shows the nine nearest waypoints that are within 100 miles of your present position. The nearest waypoints are continuously updated to your present position, and provide quick access to the closest points of safety in emergency situations.

To scroll through and review the nearest waypoint list:

1. Highlight the 'Nearest Waypoints' option and press **EDIT/ENTER**.
2. Use the **▲** keypad to scroll through the list in either direction.
3. Press **EDIT/ENTER** to review the highlighted waypoint.
4. To return to the waypoint list, highlight the 'Done?' prompt and press **EDIT/ENTER**.
5. The field highlight will automatically scroll to the next waypoint. If you want to review each waypoint, you can scroll through any waypoint list by pressing the **EDIT/ENTER** key repeatedly.

To select a nearest waypoint as a GOTO destination:

1. Use the **▲** key to select the desired GOTO waypoint.
2. Press **GOTO**, followed by **EDIT/ENTER**.

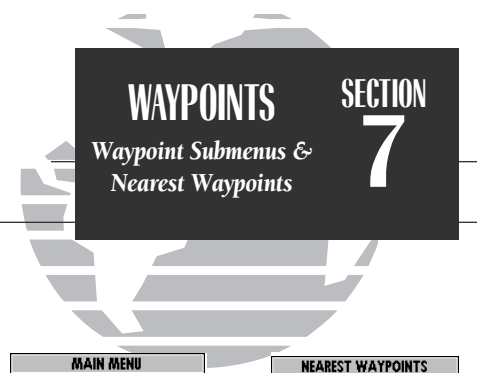

MAIN MENU	
Nearest Waypoints	
Proximity Waypoints	
Create Waypoint	
Waypoints	
Routes	
Track	
Trip & Fuel Planning	
System Setup	
Navigation Setup	
Timers & Alarms	
Input/Output	
SIM	35%

NEAREST WAYPOINTS			
WAYPOINT	BRG	DIS	
BUOY	!	179°	2.15%
STUMP4	☒	179°	2.91%
TOUR-3	◦	179°	3.62%
TOUR2	◦	179°	3.83%
TOUR1	◦	179°	4.22%
FUEL	📍	179°	4.50%
FISH-6	☒	179°	8.48%
FISH-2	☒	179°	9.00%
006	◦	179°	9.17%
SIM		57%	

A. The main menu page features four waypoint submenus.

B. The nearest waypoint list continuously updates to show the nine nearest waypoints to your present position.

SECTION 7

WAYPOINTS

Proximity Waypoints

PROXIMITY WAYPOINTS

WAYPOINT	DIS
COVE	1.00n
FISH-2	0.40n
STUMP4	0.20n
BUOY	2.00n
-----	-----
-----	-----
-----	-----
-----	-----
-----	-----
-----	-----
-----	-----

ALARMS

On

SIM 49%

PROXIMITY WAYPOINTS

WAYPOINT	DIS
COVE	1.00n

CLEAR ALL ALARMS

Note: This will clear all proximity alarms

Are You Sure?

YES NO

ALARMS

On

SIM 55%

A

B

- A. Whenever you enter a proximity waypoint's alarm circle, a 'PRX' indicator will appear in the status bar (the alarms option must be set to the 'On' position). Once you've left the alarm circle, the proximity indicator will automatically reset.
- B. To clear all proximity waypoints, select the 'Clear All?' option from the proximity options page. Finish the deletion by confirming the 'Yes' prompt.

Proximity Waypoints

The **proximity waypoints list** lets you define an alarm circle around a stored waypoint position, and can be used to help you avoid reefs, rocks or restricted waters. Up to nine waypoints may be listed, with a maximum alarm radius of 99.99 nautical or statute miles or kilometers. If a proximity alarm circle overlaps with an existing alarm circle, a 'Proximity Overlap' message will appear each time the unit is turned on. If you enter an alarm circle overlap, you will only be alerted to the closest proximity waypoint.

To enter a proximity waypoint:

1. Highlight the Proximity Waypoint option and press
2. Use the key to highlight the first blank waypoint field and press .
3. Enter the name of the proximity waypoint using the keypad, or press to select the waypoint from the nearest waypoint list, waypoint list, or map display.
4. Press to confirm. The distance field will now be highlighted.
5. Press to begin entry of the proximity radius.
6. Use the keypad to enter a distance value (to 99.99 units) and press .

To turn proximity alarms on or off:

1. Use the keypad to highlight the alarms on/off field and press .
2. Select the desired setting and press .

To remove a proximity waypoint from the list:

1. Use the keypad to highlight the waypoint to be removed.
2. Press .
3. Highlight the 'Clear Alarm?' field and press .
4. To clear all proximity waypoints, select the 'Clear All' option and press .





Create Waypoint

The third waypoint submenu available from the main menu page is the 'Create Waypoint' submenu, which allows you to create a new waypoint by manually entering coordinates. Instructions for using the create waypoint submenu are provided on page 36.





Waypoint List

The last waypoint category available from the main menu is the **waypoints list**, which displays a master list of all waypoints currently stored in memory. From the waypoints list, you may review, edit, rename or delete individual waypoints; or delete all user waypoints. The total number of stored and available waypoints is displayed at the top of the waypoints page, with the stored waypoints arranged in numerical/alphabetical order and listed in two columns in the center of the page.





To scroll through and review the waypoint list:

1. Highlight the 'Waypoints' option from the main menu page and press .
2. Use the  keypad to scroll through the list in the desired direction.
3. Press  to review the highlighted waypoint.
4. Press  to return to the list.

To delete an individual waypoint from the list:

1. Use the  keypad to highlight the waypoint to be deleted and press .
2. Press .
3. Press the  key to confirm the deletion warning.

To delete all TracBack waypoints or the entire waypoint list:

1. Press the  key to select the options window.
2. Highlight the 'Delete TracBack' or 'Delete All User Wpts?' option and press .
3. Use the  keypad to highlight the 'YES' prompt and press  to confirm.



WAYPOINTS	
AVAILABLE	USED
003	PARK
005	T001
006	T002
007	T003
008	T004
009	-----
DIVE-5	-----
FISH-3	-----
GROUP	-----
KEYHST	-----
MARINA	-----
NASSAU	-----
SIM	75%

A

WAYPOINTS	
AVAILABLE	USED
001	FUEL
OPTIONS	
Delete Waypoint?	
Delete TracBack?	
Delete All User Wpts?	
Press MENU to see the Main Menu page.	
FISH-2	-----
FISH-6	-----
FISH-7	-----
SIM	61%

B

- A. The waypoints list displays all waypoints stored in memory in a two-column format. Temporary waypoints created by the TracBack feature are assigned a 'TXXX' name and a footprint symbol.
- B. The waypoints list options page lets you delete individual waypoints, delete TracBack waypoints or the entire waypoint list.

SECTION 8

GOTO/MOB Selecting a GOTO Destination

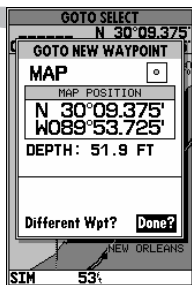

- A. Press GOTO once to select a destination from a list of waypoints.
- B. Press GOTO twice to select a destination waypoint with the map cursor. If you are not selecting an existing waypoint as your destination, a new waypoint named 'MAP' will be created. Keep in mind that the MAP waypoint will be overwritten for each MAP GOTO. This allows you to navigate to on-screen navaid's without permanently storing the navaid as a waypoint. If you want to save the MAP waypoint, rename it following the steps on page 39.

Going to a Destination

The GPSMAP 135 Sounder provides four ways to navigate to a destination: **GOTO, MOB, TracBack and route navigation**. The easiest method for selecting a destination is the GOTO function, which lets you select a destination waypoint and quickly sets a direct course from your present position. The **GOTO** key can be used in three ways: from a list of waypoints, graphically from the map display and from a list of GOTO options. Pressing the **GOTO** key once shows a list of all waypoints in memory, from which you can select a single destination waypoint.

To activate a GOTO from the waypoint list:

1. Press the **GOTO** key.
2. Select a waypoint and press **EDIT/ENTER**.

Selecting a GOTO Graphically

Pressing the **GOTO** key twice allows you to graphically select an on-screen waypoint, navaid or cursor position as a destination. A graphical GOTO may be used to select one of three options from the map display: an existing waypoint, an on-screen navaid, or a cursor position. If you are selecting a navaid or a new position as the GOTO destination, the GPSMAP 135 Sounder will automatically create or move the waypoint named 'MAP' at the navaid or map position.

To activate a GOTO from the map display:

1. Press the **GOTO** key twice.
2. To select an existing user waypoint, highlight the waypoint on screen and press **EDIT/ENTER**.
3. To select a navaid, highlight the navaid on screen and press **EDIT/ENTER**. The GOTO new waypoint page will appear, displaying the navaid position as a 'MAP' waypoint, with the navaid symbol and text as the default icon and waypoint comment. Press **EDIT/ENTER** to save the waypoint and begin navigation.
4. To select a cursor position as your destination, move the arrow cursor to the desired position and press **EDIT/ENTER**. The GOTO new waypoint page will appear and display the position as the 'MAP' waypoint. Press **EDIT/ENTER** to save the waypoint and begin navigation.

GOTO Key Options

The GOTO options page provides a list of additional GOTO options that let you start a TracBack route, select a destination waypoint from the nearest waypoints list, select a route to navigate, or cancel the current GOTO destination.

To display the GOTO options:

1. Press **MENU**.

To select a menu option:

1. Highlight the desired option and press **EDIT/ENTER**.

The following options are available:

- **Start TracBack?**— allows you to create and start navigation of a TracBack route back to the oldest track log point in memory (see pages 60-61 for more on using the TracBack function).
- **Show All Wpts?**— displays the GOTO waypoint list.
- **Show Nearest Waypoints?**— allows you to select the GOTO destination from a list of the nine nearest waypoints to your present position.

To select a nearest waypoint as a GOTO destination:

1. Highlight the 'Show Nearest Waypoints' option and press **EDIT/ENTER**.
2. Select the desired waypoint and press **EDIT/ENTER**.

- **Select Route?**— allows you to quickly select a stored route for navigation.

To select a route to navigate:

1. Highlight the 'Select Route' option and press **EDIT/ENTER**.
2. Select the desired route and press **EDIT/ENTER**.

- **Cancel GOTO?**— cancels the current GOTO destination and resumes navigation of any previously selected route.

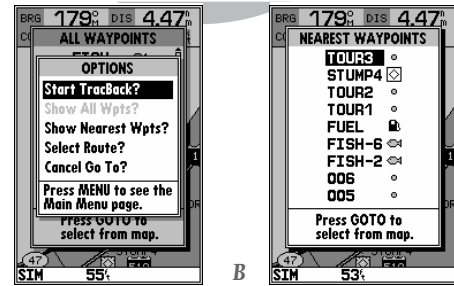

- A. The GOTO options page lets you start a TracBack route, select a destination from the nearest list, select a route to activate, or cancel the current GOTO destination.
- B. The nearest waypoints list limits the list to provide quick access to nearby anchorages, facilities, etc. which are stored as waypoints.

SECTION 8

GOTO/MOB MOB & TracBack Navigation

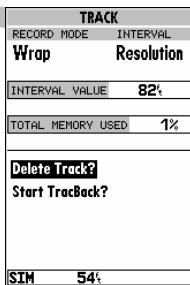
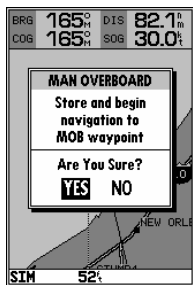

- A. The GPSMAP 135 Sounder's MOB mode can be used to set a course to a passing spot for quick response to emergency situations, fish strikes, etc.
- B. To define a starting point for a TracBack route, clear the track log.

MOB

The GPSMAP 135 Sounder's **man overboard function** (MOB) lets you simultaneously mark and set a course to a position for quick response to emergency situations.

To activate the MOB function:

1. Press the **MOB** key.
2. Press the **EDIT/ENTER** key to confirm and begin navigating to the MOB position.

Once a MOB has been activated, a MOB icon will appear on the map display, and the destination field on the map page will display the bearing, distance, and ETE to the MOB position based on your present speed and course.

To stop navigation to the MOB position:

1. Press the **GOTO** key, followed by **MENU**, to display the GOTO options page.
2. Select the 'Cancel GOTO' option and press **EDIT/ENTER**.

TracBack Navigation

The third method of navigating to a destination is by using the GPSMAP 135 Sounder's **TracBack** feature. The TracBack function allows you to retrace your path using the track log automatically stored in the receiver's memory, which will eliminate the need to store waypoints along the way. TracBack routes are created by reducing your track log into a route of up to 30 waypoints and activating an inverted route along those points. Once activated, a TracBack route will lead you back to the oldest stored track log point, so it's good idea to clear the existing track log at the start of your current trip (e.g., your dock) before you get started.

To clear the track log and define a starting point for a TracBack route:

1. Press the **MENU** key twice to display the main menu page.
2. Highlight the 'Track' option and press **EDIT/ENTER**.
3. Select the 'Delete Track?' option and press **EDIT/ENTER**.

TracBack Navigation (continued)

4. Highlight the 'Yes' field and press **EDIT** **ENTER**.

To activate a TracBack route:

1. Press the **GOTO** key, followed by the **MENU** key.

2. Highlight the 'Start TracBack?' option and press **EDIT** **ENTER**.

Once a TracBack has been activated, the GPSMAP 135 Sounder will take the track log currently stored in memory and divide it into segments called 'legs'. Up to 30 temporary waypoints (e.g. T001) will be created to mark the most significant features of the track log in order to duplicate your exact path as closely as possible. To get the most out of the TracBack feature, remember the following tips:

- Always clear the track log at the point that you want to go back to (dock, etc.).
- The 'RECORD' option on the track log setup page must be set to 'Fill' or 'Wrap'.
- There must be at least two track log points stored in memory to create a TracBack route.
- If there are not enough available waypoints in memory to create a TracBack route, you will be alerted with a 'waypoint memory full' message, and the receiver will use available waypoints to create a route with an emphasis on the track log closest to the destination.
- If the track log interval is set to the 'Time' option, the route may not follow your exact path (keep the interval set to 'resolution' for best performance).
- If the receiver is turned off or satellite coverage is lost during your trip, the TracBack will draw a straight line between any point where coverage was lost and where it resumed.
- If your track log's changes in distance and direction are too complex, 30 waypoints may not mark your path accurately. The receiver then assigns the 30 waypoints to the most significant points of your track, and simplifies segments with fewer changes in direction.
- Whenever a TracBack route is activated, the receiver will automatically erase any temporary waypoints (e.g., 'T001') that are not contained in routes 1-20. If there are temporary waypoints stored in routes 1-20, the receiver will create any new temporary waypoints using the first three digit number available.

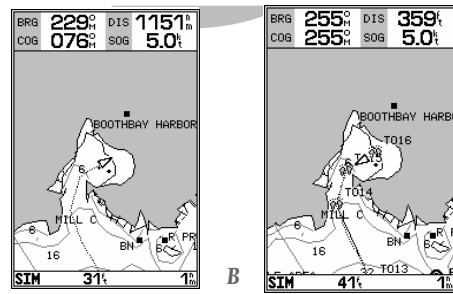
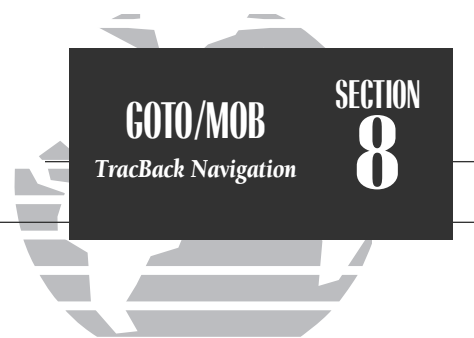

- A.** The TracBack feature uses your track log to create a route back to where you started.
- B.** Once a TracBack is activated, the track log is divided into segments using temporary waypoints, and an inverted route is activated back to the oldest track log point in memory.

SECTION 9

ROUTES Creating a Route Graphically

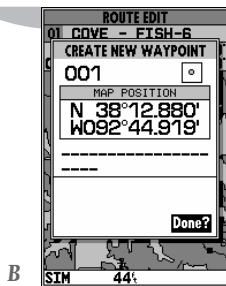
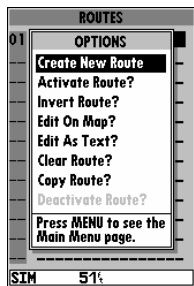

A

B

- A. The route options page provides access to the GPSMAP 135 Sounder's route functions.
- B. Use the arrow pointer and EDIT/ENTER to add waypoints to the route. The create waypoint page will appear whenever you have selected a position that is not already stored as a waypoint.

Routes

The last way to navigate to a destination is to create a user-defined route. The GARMIN GPSMAP 135 Sounder system lets you create and store up to 20 reversible routes (numbered 1-20), with up to 30 waypoints each. Routes can be created and modified right from the map page, allowing you to see each route graphically on-screen as you create, review, modify or navigate the route. All of the GPSMAP 135 Sounder's route functions are accessed through the main menu.

To create a route graphically:

1. Press the **MENU** key twice to display the main menu page.
2. Highlight the 'Routes' field and press **EDIT/ENTER**. The routes page will appear, showing all the routes currently stored in memory.
3. Press the **MENU** key to display the route options page.
4. Press **EDIT/ENTER** to select the 'Create New Route' option.

The route edit page will appear, with the cursor displayed as an arrow pointer, and will allow you to select your route waypoints using one of two methods:

5. To add an existing waypoint or navaid to the route, use the arrow pointer to highlight the desired waypoint on screen and press **EDIT/ENTER**.
6. To add a new waypoint to the route, use the arrow pointer to select the desired map position and press **EDIT/ENTER**. Press **EDIT/ENTER** again to confirm the new waypoint.

As you add each new waypoint to the route, the data window at the top of the map display will show the route number you are creating, along with the first and last route waypoints of the route. A route line will appear on the map to indicate each completed leg, and a dotted line will appear to indicate the distance and bearing to the arrow pointer from the last route waypoint.

7. Repeat steps 5 and 6 until you have finished defining all route waypoints.
8. Press **QUIT** to finish and enter review mode, or **PAGE** to return to the main page sequence.

Once a route has been created graphically (and the **QUIT** key has been pressed to finish), the map display will automatically enter the route review mode. The arrow pointer will be replaced by the map cursor, located at the last route waypoint. The route edit mode allows you to review and modify the route displayed through a pop-up window menu for each waypoint. You may also use the cursor to select an individual route leg and insert a new route waypoint.

To edit a route waypoint:

1. Use the cursor to highlight the desired route waypoint and press **EDIT/ENTER**.

A pop-up menu of editing choices will appear, with options for reviewing, removing, moving or inserting a route waypoint.

To review a route waypoint:

1. Highlight the 'Review?' option and press **EDIT/ENTER**.

To remove a route waypoint:

1. Highlight the 'Remove?' option and press **EDIT/ENTER**.

To move a route waypoint:

1. Highlight the 'Move?' option and press **EDIT/ENTER**.
2. Move the cursor to the new map position and press **EDIT/ENTER**.

To insert new route waypoint(s) at the beginning or end of the route:

1. Select the first (to add waypoints to the beginning of the route) or last (to add waypoints to the end of the route) route waypoint with the map cursor, and press **EDIT/ENTER**.
2. Highlight the 'Insert?' option and press **EDIT/ENTER**.
3. Move the cursor to the new waypoint position and press **EDIT/ENTER**.
4. If you are not inserting an existing waypoint, press **EDIT/ENTER** to confirm the new waypoint.
5. Repeat steps 3 and 4 to insert additional waypoints, or press **QUIT** to finish.

ROUTES SECTION 9

Reviewing & Editing Routes Graphically

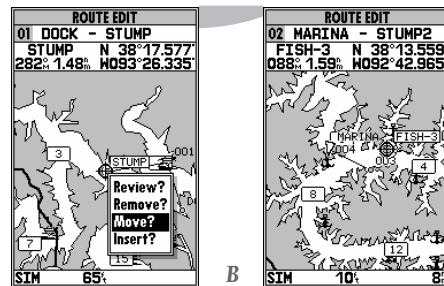

A

B

- A. To move a route waypoint, select the 'Move?' option and press **EDIT/ENTER**.
- B. Move the arrow cursor to the new waypoint position and press **EDIT/ENTER** to confirm.

SECTION 9

ROUTES Route Edit Mode

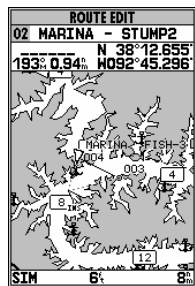

A

A. A new route waypoint may be inserted into any route leg by pointing to the new waypoint or position and pressing **EDIT/ENTER**.

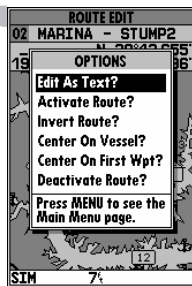

B

B. The 'Edit As Text?' option allows you to review and modify waypoints by text entry.

The GPSMAP 135 Sounder's route edit mode also allows you to insert a new route waypoint in any route leg using the map cursor.

To insert a new waypoint between two existing route waypoints:

1. Use the cursor to select the leg you want to insert the new waypoint in (the route line will change to a dotted line when the leg is selected) and press **EDIT/ENTER**.
2. Move the cursor to the new map position and press **EDIT/ENTER**.
3. If you are not inserting an existing waypoint, press **EDIT/ENTER** to confirm the new waypoint.

The route edit options page provides access to a variety of functions which can be used to review, activate, invert or edit the route as text and adjust the map view of the selected route.

To display the route edit options:

1. Press **MENU**.

To select a menu option:

1. Highlight the desired option and press **EDIT/ENTER**.

The following options are available:

- **Edit As Text?**— allows you to modify a route by text entry.

To edit a route by text entry:

1. Highlight the 'Edit As Text?' option and press **EDIT/ENTER**. The text edit page will appear, showing a list of all route waypoints, with the desired track and distance of each leg displayed.
2. Select the route waypoint you want to review or change and press **EDIT/ENTER**. A pop-up menu with four route editing options will appear.

To review the selected waypoint:

1. Highlight the 'Review?' option and press **EDIT/ENTER**.

ROUTES

Editing Routes & Route Edit Options

SECTION 9

To insert a new waypoint before the selected route waypoint:

1. Highlight the 'Insert?' option and press **EDIT/ENTER**.
2. Enter the name of the new waypoint using the **NUM** keypad, or press **MENU** to select the new waypoint from the nearest list, waypoint list, or map display.
3. Press **EDIT/ENTER** to finish.

To remove the selected route waypoint:

1. Highlight the 'Remove?' option and press **EDIT/ENTER**.

To change the selected route waypoint:

1. Highlight the 'Change?' option and press **EDIT/ENTER**.
2. Enter the name of the new waypoint using the **NUM** keypad, or press **MENU** to select the new waypoint from the nearest list, waypoint list, or map display.
3. Press **EDIT/ENTER** to finish.

The **route edit options page** features five more functions. These functions may be selected by highlighting the desired function and pressing **EDIT/ENTER**:

- **Activate Route?**— activates the route you are editing and begins navigation.
- **Invert Route?**— activates the route you are editing in reverse order and begins navigation.
- **Center On Vessel?**— redraws route edit map with your vessel in the center of the display.
- **Center On First Wpt?**— redraws route edit map with the first route waypoint in the center of the display.
- **Deactivate Route?**— stops navigation of the route currently selected.

To exit the route edit mode and return to the route list page, press the **QUIT** key.

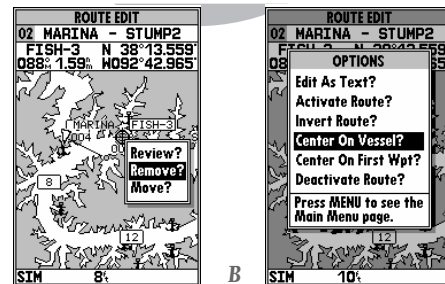

A. To remove a route waypoint, highlight the waypoint on the map, press **EDIT/ENTER**, and select the remove option from the pop-up window.

B. The route edit options page lets you activate, invert or deactivate the route you are editing. The 'Center On Vessel' and 'Center On First Wpt' options redraw the map to display the desired option.

SECTION

9

ROUTES

Route List Page

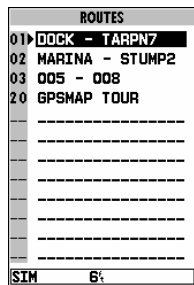

A

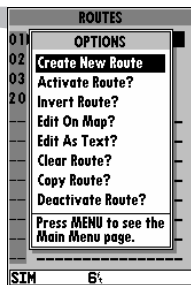

B

A. The route list page displays each route stored in memory, along with a 16-character user comment. The default comment is the name of the first and last route waypoint.

B. The route list options page provides quick access to many route functions, including activating and deactivating a selected route.

Route List Page

The GPSMAP 135 Sounder's **route list page** numerically lists all the routes currently stored in memory, with the route number and comment displayed. Route 00 is always reserved for the TracBack route, while routes 1-20 serve as storage routes (route 20 is stored as the GPSMAP tour route, which may be deleted at any time). From the list, you may enter your own 16-character route comment and select a specific route for activation, editing or other management functions.

To enter a custom route comment:

1. Highlight the desired route and press **EDIT ENTER**.
2. Press the left arrow key of the **0** keypad to clear the comment field.
3. Use the **0** keypad to enter the new route comment and press **EDIT ENTER**.

Once you have selected a route from the route page, additional functions for that route are available from the route options page.

To display the route options:

1. Press **MENU**.

To select a menu option:

1. Highlight the desired option and press **EDIT ENTER**.

The following options are available from the route list page:

- **Create New Route?**— allows you to create a new route (see page 62).
- **Activate Route?**— activates the selected route and begins navigation.
- **Invert Route?**— activates the selected route in reverse order and begins navigation.
- **Edit On Map?**— allows you to edit the selected route graphically (see pages 63-64 for specific instructions).
- **Edit As Text?**— allows you to edit the selected route by text (see pages 64-65 for specific instructions).

Route List Page Options (cont.)

- **Clear Route?**— allows you to clear all waypoints from the selected route.

To clear the selected route:

1. Highlight the 'Clear Route?' option and press **EDIT/ENTER**.
2. Press **EDIT/ENTER** to confirm the clear route warning.

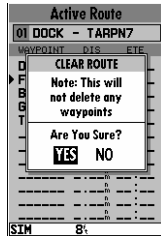

- **Copy Route?**— allows you to copy the waypoints of a selected route to another route. The route copy function can be used to copy a TracBack route (route 00) to another route in order to either prevent losing the route the next time a TracBack route is activated, or save a modified version of an existing route without losing the original.

To copy a route:

1. Highlight the 'Copy Route?' option and press **EDIT/ENTER**. The selected route will appear as the 'copy from' route, and the first open storage route will appear as the 'copy to' route.
2. Press **EDIT/ENTER** to confirm. (If you'd like to change the route number that is being copied or the open route which is being copied to, highlight the appropriate field and press **EDIT/ENTER**; select the new route number and press **EDIT/ENTER**.)

- **Deactivate Route?**— stops navigation of the route you are currently navigating.

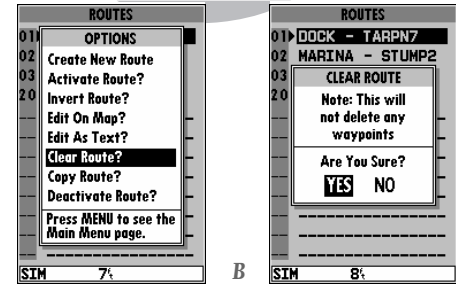

- A. To delete all waypoints from a selected route, highlight the 'Clear Route?' option and press **EDIT/ENTER**.
- B. Once a route is cleared, all waypoints are removed from the route. They are still stored in memory, however.

SECTION

9

ROUTES

Active Route Page

Active Route		
01 DOCK - TARP7		
WAYPOINT	DIS	ETE
DOCK	h	---
▶ FUEL	1.73h	10:25
BUOY	3.67h	22:02
GRUPR	5.01h	30:07
TARP7	6.00h	36:03
---	h	---
---	h	---
---	h	---
---	h	---
---	h	---
---	h	---
---	h	---
---	h	---
---	h	---
---	h	---
SIM	13:	

BUOY
 Review?
 Insert?
 Remove?
 Change?

Each waypoint on the active route page may be reviewed, deleted or changed right from the active route page. To edit an active route waypoint, highlight the desired waypoint and press **EDIT/ENTER**.

Select the desired function from the pop-up menu and press **EDIT/ENTER**.

Active Route Page

Active Route		
01 DOCK - TARP7		
WAYPOINT	DIS	ETE
DOCK	h	---
▶ FUEL	1.73h	10:25
BUOY	3.67h	22:02
GRUPR	5.01h	30:07
TARP7	6.00h	36:03
---	h	---
---	h	---
---	h	---
---	h	---
---	h	---
---	h	---
---	h	---
---	h	---
---	h	---
SIM	16:	

Whenever you have activated a route in the GPSMAP 135 Sounder system, the **active route page** will appear in the main page sequence. The active route page shows each waypoint of the active route, with the waypoint name, desired track, cumulative distance and ETE or ETA for each waypoint from your present position. The current destination waypoint, the 'active' waypoint, is marked with an arrow icon. As you navigate a route, the waypoint list will automatically update to indicate the next 'active' waypoint first.

From the active route page, you can:

- **Change the route comment**- see page 66 for instructions.
- **Edit the route as text**- see pages 64-65 for instructions.

Additional functions for the active route are available from the **active route options page**.

To display the active route options:

1. Press **MENU**.

To select a menu option:

1. Highlight the desired option and press **EDIT/ENTER**.

Active Route Page Options



The following options are available from the active route page:

- **Invert Route?**— activates the active route in reverse order and begins navigation.
- **Activate Route?**— reactivates the active route and selects the route leg closest to your current position as the new active leg.
- **Edit On Map?**— allows you to edit the selected route graphically (see pages 63-64 for specific instructions).
- **Clear Route?**— allows you to clear all waypoints from the selected route.
- **Copy Route?**— allows you to copy the waypoints of the active route to another route.
- **Change Data Fields?**— allows you to define the data displayed in the distance and ETE fields. four data options are available:
 - DIS— distance to active wpt
 - DTK— desired track
 - ETE— estimated time enroute
 - ETA— estimated time of arrival
- **Restore Defaults?**— resets all active route page options to the factory settings.
- **Deactivate Route?**— stops navigation of the route you are currently navigating.
- **Setup Simulator?**— allows you to define speed, course and position values while in simulator mode. See the Getting Started Tour for more on using the simulator mode.

ROUTES

Active Route Page Options

SECTION 9

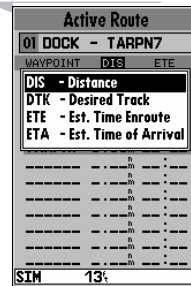

The 'Change Data Fields?' option lets you specify what information is displayed for each route waypoint. Four data options are available: distance, desired track, and ETA or ETE to each route waypoint.

SECTION 10 SETUP MENUS

Track Log Setup

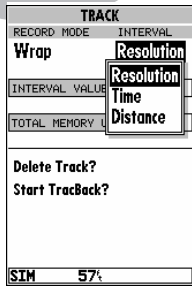

Track Log Submenu

The GPSMAP 135 Sounder's **main menu page's track submenu** lets you specify whether or not to record a track plot (an electronic recording of your path) and define how it is recorded. It also provides an indicator of the track memory used and selects functions to clear the track memory and start a TracBack route. The following functions are available:

- **Record Mode**— lets you select one of three track recording options:
 - Off— No track log will be recorded. Note that selecting the 'Off' setting will prevent you from using the TracBack feature.
 - Fill— a track log will be recorded until the track memory is full.
 - Wrap— A track log will be continuously recorded, wrapping through the available memory (replacing the oldest track data with new data).
- **Interval**— defines the frequency with which the track plot is recorded. Three interval settings are available:
 - Time— records track plot based on a user-defined time interval.
 - Resolution— records track plot based upon a user-defined variance from your course over ground. The resolution option is the default setting and is recommended for the most efficient use of memory and TracBack performance. The distance value (entered in the interval field) is the maximum error allowed from the true course before recording a track point.
 - Distance— records track based on a user-defined distance between points.
- **Interval Value**— defines the distance or time used to record the track log.
- **Delete Track?**— allows you to clear the track log currently stored in memory.
- **Start TracBack?**— converts the current track log into an inverted route and begins route navigation along the track log.

To reset all track options to the default settings:

1. Press **MENU**, followed by **EDIT ENTER**.

A. The 'Wrap' option will continuously record a track log, and replace the oldest track log point with new data. The 'Fill' option will record a track log until the memory is full.

B. The track submenu's default settings may be quickly restored from the track options page.

Trip and Fuel Planning

The GPSMAP 135 Sounder's **trip and fuel planning submenu** lets you plan and review distance, fuel, and ETE/ETA information between any two waypoints; your present position and a stored waypoint; or any part of a stored route. Sunrise and sunset information is also provided. Two planning modes are available: point-to-point and route planning.

To use the point-to-point planning mode:

1. Highlight the 'Trip & Fuel Planning' option from the main menu page and press **EDIT/ENTER**.
2. If the plan field is not set to 'Point-To-Point', press the **MENU** key and select it from the options page.
3. Highlight the first waypoint field and press **EDIT/ENTER**. Press the left arrow key to clear the field, and use the **⊙** keypad to enter the name of the starting waypoint. You may leave the waypoint field blank to use your present position, or press the **MENU** key to select the waypoint from the nearest list, the waypoint list, or the map display. Press **EDIT/ENTER** to confirm the waypoint.
4. Move the field highlight to the second waypoint field and follow the steps above to select the destination waypoint.
5. Enter a speed for your trip in the speed field, or press **MENU** to select your current SOG for the speed value.
6. Enter an hourly fuel flow (if desired) in the fuel field, and press **EDIT/ENTER**.
7. Enter the date and time of your departure (the default date and time will be the current date and time in UTC or local time, whichever you have selected) and press **EDIT/ENTER**.

The bottom of the page will now display the desired track and distance between the two points; the estimated time enroute and fuel required; the date and time of your arrival; and the sunrise and sunset times at the destination for the date of arrival.

The **route planning mode** lets you calculate the same planning information for any route stored in memory, in leg or cumulative leg or route totals.



A

TRIP & FUEL PLANNING	
PLAN	Point-To-Point
KEYWST to	NASSAU
SPEED	0.0
FUEL FLOW	0.0/hr
DEPART	18-JUN-96 12:25
DTK	086% FUEL
DIS	238.9% ETE
ETA	DATE
DATE	SET
SIM	55%

B

TRIP & FUEL PLANNING	
PLAN	Point-To-Point
KEYWST to	NASSAU
SPEED	35.0
FUEL FLOW	23.0/hr
DEPART	18-JUN-96 12:25
DTK	086% FUEL 157.0
DIS	238.9% ETE 06:49
ETA	07:14 RISE 05:20
DATE	18-JUN SET 07:02
SIM	57%

A. To perform point-to-point planning, enter a 'TO' and 'FROM' waypoint, or leave the field blank if you want to use your present position.

B. Enter a date and time for your departure. The sunrise/sunset and ETA at the 'TO' waypoint will be displayed at the bottom of the page.

SECTION 10 SETUP MENUS

Route & Trip Planning

A

TRIP & FUEL PLANNING		
PLAN	ROUTE	LEG
Route	04	ALL
BUOY05 to DIVE-4		
SPEED	35.0:	
FUEL FLOW	30.0 _{hr}	
DEPART	11-JUN-96 07:16:	
DTK	FUEL	224.5
DIS	ETE	07:29
ETA	RISE	06:36:
DATE	SET	08:15:
SIM	17:	

B

TRIP & FUEL PLANNING		
PLAN	ROUTE	LEG
Route	04	05
010 to DIVE-4		
SPEED	35.0:	
FUEL FLOW	30.0 _{hr}	
DEPART	11-JUN-96 07:16:	
DTK	FUEL	43.6
DIS	ETE	01:27
ETA	RISE	06:36:
DATE	SET	08:15:
SIM	23:	

- A.** To plan cumulative totals for an entire route, select the 'All' option from the leg field.
- B.** To plan cumulative totals through a particular leg, select the 'Hold First Waypoint?' option from the Trip and Fuel Planning options page. Then enter the last leg you want to plan in the leg field.

To use the route planning mode:

1. Highlight the 'Trip & Fuel Planning' option from the main menu and press **EDIT ENTER**.
2. If the plan field is not set to 'Route', press **MENU** and select it from the options page.
3. Highlight the route number field and press **EDIT ENTER**.
4. Use the **0** keypad to select the route you want to plan and press **EDIT ENTER**.
5. Highlight the leg field and press **EDIT ENTER**.
6. To plan the cumulative totals for the all route legs, select the 'ALL' option—or use the **0** keypad to select a specific route leg to plan. Press **EDIT ENTER** to confirm.
7. Enter a speed for your trip, or press **MENU** to select your current SOG for the speed value.
8. Enter an hourly fuel flow (if desired) in the fuel field, and press **EDIT ENTER**.
9. Enter the date and time of your departure (the default date and time will be the current date and time in UTC or local time, whichever you have selected) and press **EDIT ENTER**.

The bottom of the page will now display the planning information for the route leg selected or the cumulative values for the entire route. The route planning mode will also let you plan cumulative totals for multiple route legs by using the 'Hold First Waypoint?' selection from the options window.

To plan multiple route legs:

1. Follow steps 1 through 6 above to select the last route leg you want to plan. For example, select leg 03 if you want to plan cumulative totals for the first three legs of the route (without including the rest of the route).
2. Enter the speed, fuel and date/time values as described in steps 7-9 above.
3. Press the **MENU** key to display the options page.
4. Select the 'Hold First Waypoint?' option and press **EDIT ENTER**. The cumulative totals from the first route waypoint to the end of the selective leg will appear at the bottom of the page.

The fuel and trip planning submenu also allows you to calculate the sunrise and sunset times for your present position or any waypoint for a selected date.

To use the sunrise/sunset planner:

1. Highlight 'Trip & Fuel Planning' option from the main menu and press **EDIT ENTER**.
2. Highlight the first waypoint field and press **EDIT ENTER**. Press the left arrow key to clear the field, and use the **0** keypad to enter the name of the desired waypoint. You may leave the waypoint field blank to use your present position, or press the **MENU** key to select the waypoint from the nearest list, the waypoint list, or the map display. To calculate the sunrise/sunset for your present position, leave both waypoint fields blank.
3. Press **EDIT ENTER** to confirm.
4. Highlight the date field and press **EDIT ENTER**.
5. Enter the date you want sunrise/sunset information for (the current date and year will be used as the default setting) and press **EDIT ENTER**. The sunrise and sunset times for the arrival date will be displayed at the bottom right of the planning page.

Setup Submenus

The last four options available from the main menu page provide access to the various system, navigation, alarm and interface settings of the GPSMAP 135 Sounder. The **system setup submenu** is used to select the operating mode, date and time formats, tone preferences, backlight timeout and display contrast.

- **Operational Mode** lets you select between normal, simulator, sounder only, or GPS only mode. In normal mode both GPS and sounder functions operate at the same time. In simulator mode, the GPSMAP 135 Sounder's system only pretends to track satellites to allow you to learn how the unit works. Simulator mode should not be used for actual navigation. Waypoints and routes created in simulator mode are saved in memory and are available for use in normal mode. The sounder only and GPS only modes allow you to determine what type of information the GPSMAP 135 Sounder will give you. GPS only mode is useful when using the unit for land navigation while enroute to the water. Sounder only mode is an option if you do not want GPS information (such as position, speed, heading, and map functions) while on the water.

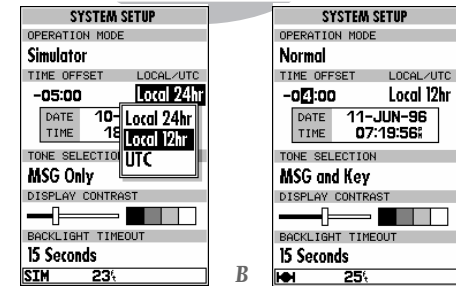
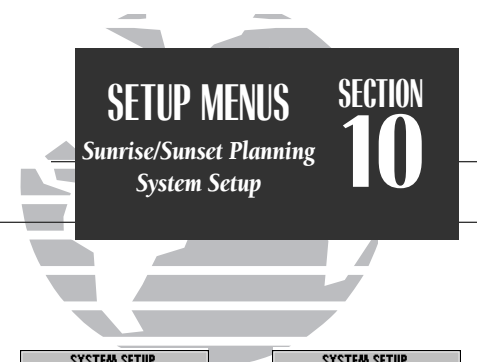

- A. The system setup submenu provides access to the GPSMAP 135 Sounder's time formats and contrast/backlight controls.
- B. When entering a time offset, be sure to select a positive or negative indicator to the left of the offset value.

SECTION 10 SETUP MENUS

System Setup & System Setup Options

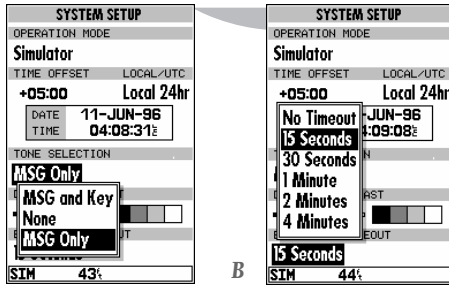

- A. The 'None' tone setting will prevent an audible tone from sounding for any key presses, messages, or alarms. Regardless of the tone setting, 'MESSAGE -PRESS PAGE' will continue to be flashed on the status bar for any system messages or alarms.
- B. Keeping the backlight timeout at the lowest acceptable setting will prolong the useful life of the backlight.

- **Time Offset** provides a data entry field to enter the time difference between UTC time and the local time. (See Appendix F for a list of time offsets.) When entering a time offset, be sure to select a positive or negative offset. Note that entering an offset will not automatically display local time. The *local* setting from the Date/Time Selection submenu must be selected.
- **Local/UTC** lets you choose to display the date and time in UTC (Greenwich Mean Time) time or local time offset from UTC time. The default setting is local with a '0' offset. (If you are boating in the United States, be sure to enter a negative time indicator in front of the appropriate time offset for your location).
- **Tone Selection** lets you select an audible tone to sound for either messages and keystroke confirmation (the default setting), messages only, or not to sound at all. Note: Setting the tone selection for no sound will prevent an audible tone for all alarms, including shallow water and proximity waypoints.
- **Display Contrast** provides a slide bar to adjust the LCD screen contrast in order to compensate for changes in temperature or lighting conditions.
- **Backlight Timeout** provides an automatic shutoff for the GPSMAP 135 Sounder's screen backlighting. Six settings are available: No Timeout (the backlight will stay on until it is turned off), 15 seconds (default setting); 30 seconds; and 1, 2, or 4 minutes. Keeping the timeout at the lowest acceptable setting will prolong the life of the backlight.

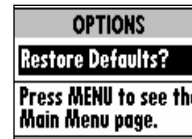

The system setup page also features an options page that allows you to quickly reset all the system setup options to the factory default settings and define speed, course and position values while in simulator mode (see Getting Started Tour).

To view the system setup page options:

1. Press the **MENU** key.

To restore the default settings:

1. Highlight the 'Restore Defaults?' option, and press **EDIT ENTER**.

Navigation Setup

The navigation setup submenu is used to select a variety of navigation information including: position format, units of measure, and heading preferences. This submenu is also used to select map datums, set the CDI scale and adjust the built-in velocity filter. The following options are available:

- **Position Format** lets you select the coordinate system used to display position. The following formats are available:
 - hddd.dddd° (degrees)
 - hddd°mm.mmm' (degrees and minutes)
 - hddd°mm'ss.s" (deg/min/sec)
 - British grid
 - German grid
 - Irish grid
 - Maidenhead
 - Swedish grid
 - Swiss grid
 - Taiwan grid
- **Navigation Units** selects the format for speed and distance measurements. You may select from nautical, statute or metric formats. (The default setting is nautical.)
- **Depth Units** selects the format for depth contour display on G-chart offshore chart cartridges and the sounder display. Depth contours and sounder depth units can be displayed in feet, meters or fathoms. (The default setting is feet.)
- **Heading** lets you select what reference is used in calculating heading information. You can select to reference automatic magnetic variation, true north, grid heading or user magnetic variation. (The default setting is automatic.)

To enter a user magnetic variation:

1. Highlight the 'Heading' field and press **EDIT ENTER**. Select the 'User Mag Var' option and press **EDIT ENTER**.

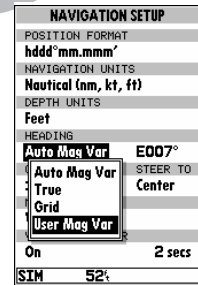
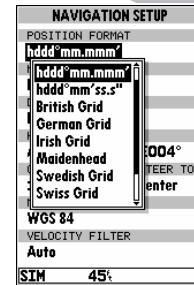

- A. The GPSMAP 135 Sounder will also display position coordinates in eight grid formats.
- B. To enter a user magnetic variation, select the 'User Mag Var' option and enter a direction and value in the variation field.

SECTION 10 SETUP MENUS

Navigation Setup

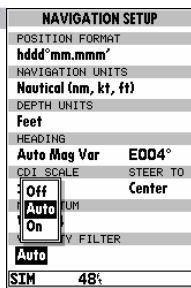
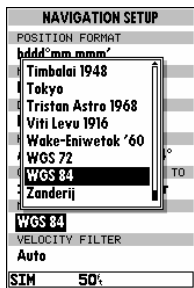

- A. **CAUTION!** Using the incorrect map datum can seriously effect the accuracy of your GPS receiver. The GPS datum should always match the datum of the local chart you are using. If no datum information is indicated on the charts you are using, contact the chart manufacturer.
- B. Keeping the velocity filter on the 'Auto' setting will allow the GPSMAP 135 Sounder to automatically monitor and adjust the response time for track and speed calculations.

2. Press **EDIT ENTER** to access the variation field, and use the **0** keypad to enter the desired variation. Press **EDIT ENTER** to confirm.

- **CDI Scale** provides a list of six CDI scale settings for the map page CDI: +/-0.10, 0.50, 1.0 (default). 5.0, 10.0 and 25.0 miles or kilometers. The scale represents the distance from the center of the scale to either end of the scale.
- **CDI Steer To** allows you select a steer-to-center or steer-to-D-Bar orientation for graphic steering guidance. The steer-to-center selection displays your position as the vertical line on the scale, and your desired track as the center of the scale. The steer to D-Bar option displays your position as the center of the scale, with the desired track as the vertical line. The default setting is steer to center.
- **Map Datum** provides a list of the available map datums for use with the GPSMAP 135 Sounder system. For a list of the available map datums, see Appendix D. The default setting is WGS 84.
- **Velocity Filter** allows you to select the GPSMAP 135 Sounder's response time to changes in track or ground speed. Three settings are available: automatic, on, or off. The 'auto' (default) setting will monitor the changes in your current track and speed and adjust the receiver's response time automatically. The 'on' setting allows you to manually enter a response time up to 240 seconds. Selecting a higher setting may be desirable in slow-speed applications with frequent changes in track.



To enter a user defined velocity filter value:

1. Highlight the 'Velocity' field and press **EDIT ENTER**. Select the 'On' option and press **EDIT ENTER**.
2. Highlight the time value field.
3. Press **EDIT ENTER**.
4. Enter a value in seconds (up to 240) and press **EDIT ENTER** to confirm.

Timers & Alarms Setup

The timer & alarms submenu is used to control various alarm/timer settings.

- **Timer** sounds an alarm when an entered interval (up to 99:59:59) has expired, or provides a continuous running clock timer to 99:59:59.

To use the countdown timer:

1. Select the 'Count Down' menu option.
2. Enter the desired time interval in the interval field, and press **EDIT ENTER**.
3. Once the count down time has expired, an alarm message will appear, and the timer will automatically switch to the count up mode.
4. To reset the timer, select the reset option and press **EDIT ENTER**.

- **Clock Alarm** provides an alarm for the system clock. To use the clock alarm, select the 'On' option and enter the desired time of day in the time field.
- **Arrival Alarm** lets you specify an alarm to sound when you're a specified distance away from a destination waypoint. Three options are available:
 - Off- No arrival alarm will sound.
 - Auto- An arrival alarm will sound one minute before the destination, based upon your current speed and course over ground.
 - On- An arrival alarm will sound at the alarm distance specified in the distance field for the destination waypoint (the 'On' setting will only provide an arrival alarm for the final destination waypoint of the active route).
- **Crosstrack Alarm** provides an alarm for crosstrack error (XTK) when your vessel is off course by more than a specified distance, up to 99.99 (units).
- **Anchor Drag Alarm** lets you specify an alarm to sound when you've exceeded a specified drift distance, up to 9999 (units). Whenever the anchor alarm is triggered, an anchor icon will appear in the status bar.

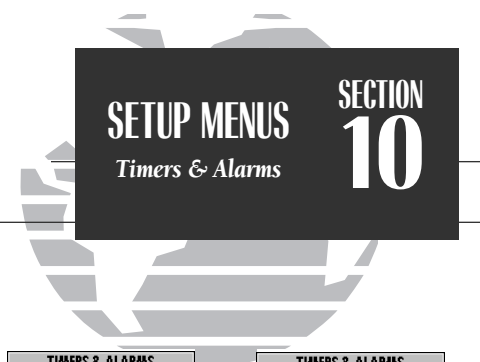

A

TIMERS & ALARMS	
TIMER	
Stop	03:54:32
Count Down	
Count Up	14:00
Reset	
Stop	
ALARM	
Off	2.00%
ANCHOR DRAG ALARM	
Off	10%
SOUNDER ALARMS	
Shallow Off	10.0%
Deep Off	200.0%
Fish Off	Med-Lrg Targets
SIM	47%

B

TIMERS & ALARMS	
TIMER	
Stop	03:54:32
CLOCK ALARM	
Off	14:00
ARRIVAL ALARM	
Off	
CROSS-TRACK ALARM	
Off	2.00%
ALARM	
Shallow Off	
Shallow On	10%
SOUNDER ALARMS	
Shallow Off	10.0%
Deep Off	200.0%
Fish Off	Med-Lrg Targets
SIM	45%

- A. The timer field can be set to count down from a specified interval or provide a running count of elapsed time.
- B. The sounder alarms can be set to warn you of deep or shallow water and sounder targets of various sizes.

SECTION 10 SETUP MENUS

Input/Output Setup

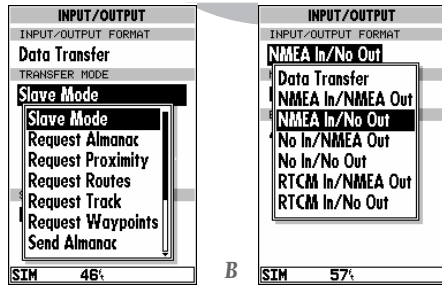

A. The data transfer options allow you to send or receive almanac data, proximity waypoints, routes, track log data and waypoints to another GARMIN GPS or PC Kit.

B. The NMEA In setting allows you to accept NMEA data from a Yeoman plotter or other compatible device.

- **Sounder Alarms** allows you to set shallow and deep depth alarms and an alarm for specific sized fish/targets. Three options are available:
 - Shallow On/Off- Sounds if depth equals or is less than the selected value.
 - Deep On/Off- Sounds if depth equals or is more than the selected value.
 - Fish On/Off- Select from All Targets, Medium-Large Targets, or Large Targets.

Input/Output Submenu

The Input/Output submenu lets you control interface settings for connecting external NMEA devices, a DGPS receiver or a personal computer. The 'Input/Output Format' field, at the top of the page, lets you specify one of seven interface formats:

Data Transfer is a proprietary interface that allows you to exchange data such as waypoints, routes and track logs between GPSMAP units or a GARMIN PC kit.

No In/NMEA Out provides navigation information to a compatible NMEA device such as an autopilot or radar. NMEA 0180, 0182, 0183 v.1.5 and 0183 v.2.0 output options are available. See Appendix A for additional NMEA sentence information.

No In/No Out provides no interfacing capabilities.

RTCM In/NMEA Out allows DGPS beacon receiver input and also provides selectable NMEA output.

RTCM In/No Out allows DGPS beacon receiver input, with no output capabilities.

NMEA In/No Out allows input from a NMEA compatible external device, such as a Yeoman© Plotter, with no output capabilities.

NMEA In/NMEA Out provides the same input capabilities as NMEA IN, with selectable NMEA output.

When the 'Data Transfer' option is selected, you'll need to specify what information to request or send to the remote unit through the Transfer Mode field. The 'slave' setting lets you control all data transfer from the 'external' GPS receiver, or PC while the other settings request or send specific data from the primary unit.

Using NMEA & DGPS Interface Settings

If you are using an NMEA interface format, the NMEA format must be specified in the NMEA format field that will automatically appear when an NMEA option is selected. The appropriate baud rate will be set automatically.

To select a NMEA format:

1. Select a NMEA IN/OUT format from the options page.
2. Highlight the NMEA Format field and press **EDIT ENTER**.
3. Select a NMEA sentence format and press **EDIT ENTER**.
4. The baud rate will automatically be set to the appropriate speed. If you have selected an NMEA IN/OUT setting, you must use the same NMEA format for both the input and output device.

Tuning DGPS Stations

If the I/O Format is set to accept RTCM input/NMEA Output for connecting a differential-ready GPS beacon receiver, you will need to tune a frequency in the tuning field and select a bit rate. The default frequency will be 304.0 kHz, with a bit rate of 100 bps, or the last DGPS frequency/bit rate selected.

To tune a DGPS frequency:

1. Select the 'RTCM In/NMEA Out' format from the options page.
2. Highlight the beacon receiver frequency field and press **EDIT ENTER**.
3. Enter the desired frequency and press **EDIT ENTER**. If you are using an automatically-tuned DGPS receiver, you may enter 000.0 for the frequency.
4. Press **EDIT ENTER** to select a bit rate. Five bit rates are available: 0 (used for automatically-tuned DGPS receivers), 25, 50, 100 and 200 bps. Press **EDIT ENTER** to confirm. The DGPS status, along with the signal-to-noise ratio of the tuned station, will be displayed at the bottom of the page.

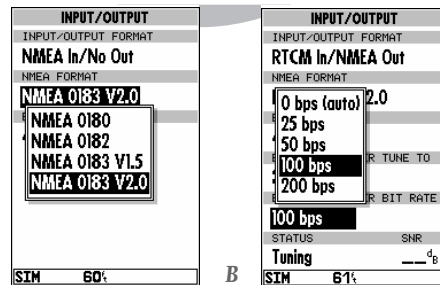
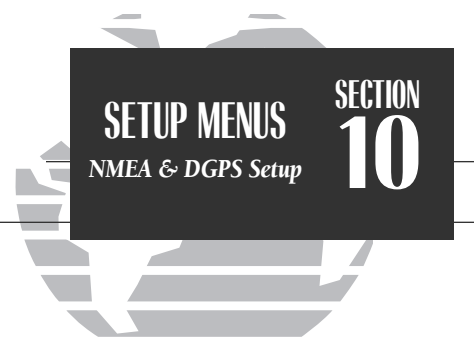

- A. Select the desired format from the NMEA field. The baud rate will automatically be set to the appropriate speed.
- B. After entering a DGPS frequency, set the bit rate to the speed indicated on the USCG station chart. DGPS coverage, frequencies and bit rates are available from the Coast Guard's automated FAX service (703-313-5920).

SECTION 11

G-CHARTS Loading & Removing G-Charts

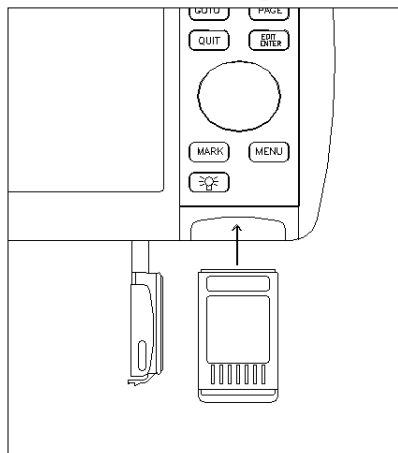

Installing & Removing G-chart Cartridges

The GARMIN GPSMAP 135 Sounder system uses G-chart offshore or inland cartography to display digital charts on-screen. G-chart cartridges are installed in the card slot located at the bottom right of the GPSMAP 135 Sounder unit. G-chart cartridges may be installed or removed at any time, whether the unit is on or off.

To install a G-chart cartridge:

1. Open the cartridge door.
2. Insert the card (label facing front and G-chart logo at top) into the slot.
3. Use your thumb to firmly push the cartridge into place (until the cartridge will not go any further into the unit). If your GPSMAP 135 Sounder is on, a confirmation tone will sound when the cartridge has been properly installed and accepted.
4. Close the cover.



If you insert a G-chart cartridge and get a 'card format not recognized' message, try removing the card and reinserting it. If the card is still not recognized, contact the dealer you purchased it from for assistance. G-chart cartridges are not waterproof, should not be exposed to moisture or excessive static charges, and should be stored in the anti-static bag supplied with the cartridge.

To remove a G-chart cartridge:

1. Open the cartridge door.
2. Grasp the card at the bottom groove and pull firmly.
3. If your GPSMAP 135 Sounder is on, a confirmation tone will sound when the G-chart cartridge has been removed.

Using G-chart Cartography

Once a G-chart cartridge has been inserted, the map coverage outlines for the cartridge will automatically appear on-screen. Keep in mind that the display will not automatically scroll to the map area or zoom to a level where you can see the coverage outlines. If you do not immediately see the outlines, scroll the cursor to the broad geographic area covered by the chart and zoom out to another map scale.

The large outlined box shown is the main chart, which serves as the boundary area for the entire cartridge. The small outlined box inside the main box are sub-charts, which provide more detailed coverage of the area indicated. To view the detailed cartography of any subchart, scroll the cursor to the subchart outline and use the  key to zoom in to smaller range scales. If the map outlines still do not appear, check the 'Map Outlines' setting on the map options page to make sure they are set to appear (see page 40).



Whenever you zoom past the usable range of the current electronic chart, the range field will display 'Ovr Zm' or 'No Map'. These warnings indicate that although you may still have cartography, you should exercise extreme caution using the data. See page 39 for more information on Overzoom and No Map modes.

When a G-chart cartridge is installed, the GPSMAP 135 Sounder's system will automatically use the best available chart for display. As you enter and exit various subcharts, the system will automatically display the appropriate chart for the area you are in. When you leave the area covered by the main map of a cartridge, the GPSMAP 135 Sounder will default back to using the built-in 64 nm database if it is available at the current scale.

If you are not seeing certain map items (navaids, depth contours, etc. on offshore cartridges; highways, boat ramps, etc. on inland cartridges), check the map configuration settings available from the map options page.

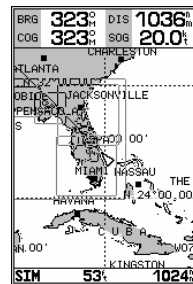
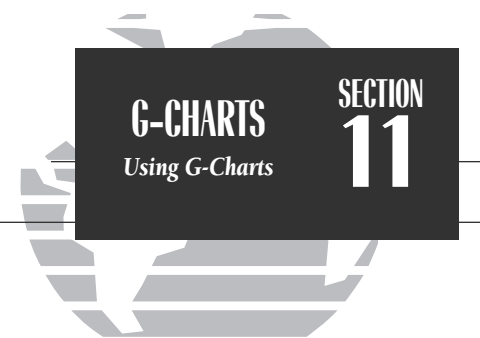

A

B

- A. Map outlines for G-chart offshore cartography.
- B. Map outlines for G-chart inland cartography.

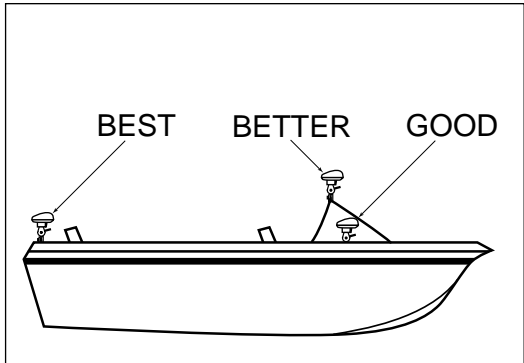

Installing the GPSMAP 135 Sounder

The GPSMAP 135 Sounder must be properly installed according to the following instructions to get the best possible performance. Included with your sounder is GARMIN power data cable (part no. 320-00023-06) and transducer with cable (part no. 493-10000-00) which must be used to comply with FCC regulations. To complete the installation, you'll need the appropriate fasteners and a 1" x 14-thread marine antenna mount available at most marine dealers. Also included are ferrite bead filter clamps (part no. K00-00036-00) which filter RFI radiation from interfering with nearby electronics. (See appendix C for ferrite clamp installation.)

Mounting the GPS antenna

The antenna should be mounted in a location that has a clear, unobstructed view of the sky in all directions to ensure the best reception. Avoid mounting the antenna where it will be shaded by the boat's superstructure, a radome antenna, or mast. Sailboat users should avoid mounting the antenna high on the mast to prevent inaccurate speed readings caused by excessive heeling. Most marine VHF and loran antennas will not seriously degrade the GPS antenna's reception. Never paint the antenna or clean it with harsh solvents.

The GARMIN antenna screws directly onto any standard 1" x 14-thread antenna mount. If you need to raise the antenna to avoid shading, try using a 1" x 14-thread extension mast available at most marine dealers.

To install the GPS antenna:

1. Screw the antenna directly onto the 1" x 14-thread mount.
2. Route the cable to the mounting location of the display unit. Use the appropriate tie-wraps, escutcheon plates and sealant to secure the cable along the route and through any bulkhead or deck.
3. Once the GPSMAP 135 Sounder unit has been installed, connect the cable to the antenna connector on the back of the display unit. Make sure that you turn the antenna cable connector 1/4 turn clockwise to lock the cable into place.

Mounting the GPSMAP 135 Sounder Unit

The GPSMAP 135 Sounder's compact, waterproof case is suitable for mounting in exposed locations or at the nav station. The unit comes with a gimbal bracket that can be used for surface or overhead mounting. When choosing a location for the display unit, make sure you consider the following conditions:

- There should be at least a 3" (5 cm) clearance behind the case to allow connection of the antenna, power/data cables, and ferrite clamps.
- The unit should not be mounted where it is exposed to excessive temperatures for extended periods (see page 84).
- You should provide adequate clearance for the G-chart cartridge cover to swing open freely. You may have to swivel the unit to get a firm grip on the cartridge.
- The mounting surface should be heavy enough to support the unit and protect it from excessive vibration and shock.
- For flush mounting, make sure the flat panel is between 0.08" and 0.30" (2 to 7.7mm) thick to use the cam lobe built into the mounting bracket.

To install the GPSMAP 135 Sounder unit:

1. Place the mounting bracket in the desired location.
2. Mark and drill the four mounting holes for the fastener you are using.
3. Fasten the bracket to the surface using the appropriate fastener.
4. Insert the GPSMAP 135 Sounder into the mounting bracket. The bracket is designed for a tight fit to provide additional support when swiveling the unit.
5. Screw the two mounting knobs through the bracket and into the display case.
6. Connect the power/data and antenna cables to the back of the unit, making sure the locking rings are fully tightened on both connectors.

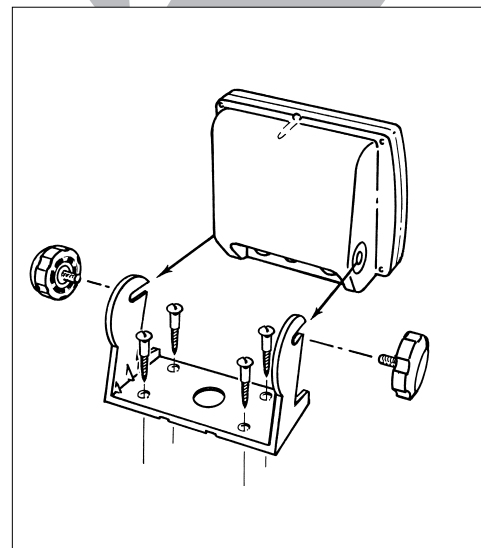

APPENDIX

Installation

SECTION A

WARNING!

The temperature range for the GPSMAP 135 Sounder is -4 to +158°F (-20 to 70°C). Extended exposure to temperatures exceeding this range (in storage or operating conditions) may cause failure of the LCD screen. This type of failure and related consequences are NOT covered by the manufacturer's limited warranty.

To flush mount the GPSMAP 135 Sounder:

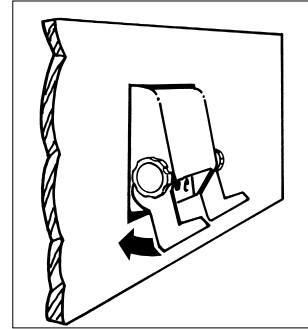

1. Cut a 4.15" W x 4.67" H (105.4 x 118.6mm) hole in panel.
2. Place GPSMAP 135 Sounder into hole from the front until its flange rests against the mounting surface.
3. From the back side of the panel, loosely attach the bracket so that the slot in the ratchet area points away from the mounting panel.
4. Rotate the bracket downward until the panel is pinched tightly between the unit's flange and bracket lobe.
5. Tighten knobs and connect the power/data and antenna cables.

Transducer Installation

For installation, please refer to the booklet included with the transducer unit.

Installing the Ferrite Clamps

In order to filter Radio Frequency Interference (RFI) radiation which would possibly interfere with items such as televisions, radios, or other depth sounders which are operating in close proximity to the GPSMAP 135 Sounder, two ferrite bead filter clamps are included for attachment to the unit's cables. The clamps attach to your transducer and power cables near the point at which they connect to the back of your GPSMAP 135 Sounder.

To install the ferrite bead filter clamps:

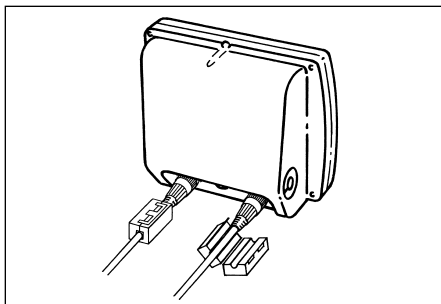

1. Choose a location which is no more than two inches from the back of the GPSMAP 135 Sounder.
2. Open each filter clamp by slightly pulling out on the latch and opening the filter halves.
3. Position each clamp and squeeze it shut around the cable until the latch is securely fastened.

The clamps should not need to be replaced under normal use.

If you have any questions or require replacement filter clamps, contact your local GARMIN dealer.

APPENDIX Installation

SECTION A

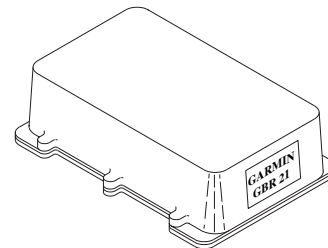

DGPS corrections are accepted in RTCM-104 v. 2.0 format through the NMEA In (BROWN) harness lead. The GARMIN GBR 21 is the recommended beacon receiver for use with the GPSMAP 135 system. Other receivers with the correct RTCM format may be used, but may not correctly display status or allow tuning control from the sounder unit.

Connecting the Power/Data Cable

The power/data cable connects the GPSMAP 135 Sounder to a 10-40 volt DC system and provides interface capabilities for connecting external devices, including an external alarm. The color code in the diagram below indicates the appropriate harness connections.

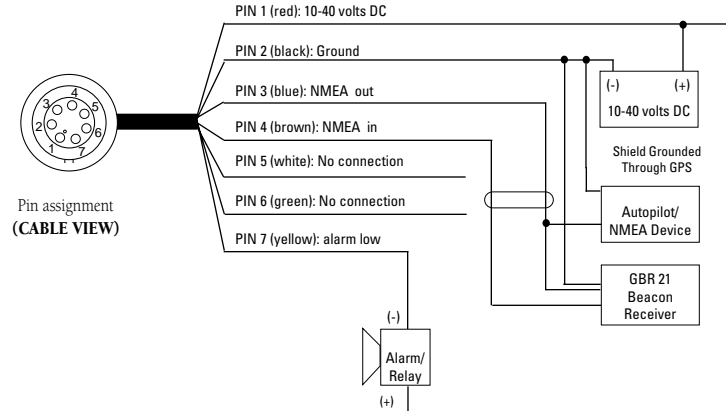

The following formats are supported for connection to up to 3 NMEA devices:

- NMEA 0180/NMEA 0182
- NMEA 0183 version 1.5
 - Approved sentences— GPBWC, GPGLL, GPRMB, GPRMC, GPXTE, GPVTG, GPWPL, GPBOD
 - Proprietary sentences— PGRMM, PGRMZ (alt.), PSLIB (beacon receiver control input)
- NMEA 0183 version 2.0
 - Approved sentences— GPGGA, GPGLL, GPGSA, GPGSV, GPRMB, GPRMC, GPRTE, GPWPL, GPBOD
 - Proprietary sentences— PGRME (estimated error), PGRMM (map datum), PGRMZ (altitude), PSLIB (beacon rec. control input)

GPSMAP 135 Sounder Specifications

PHYSICAL

Case:	Screwed shut and dry nitrogen-filled
Size:	4.9"H x 5.3"W x 2.4"D (12.5 x 13.5 x 2.4 cm)
Weight:	Less than 1 lb. (454g)
Temperature Range:	-4° to +158°F (-20° to 70°C)

PERFORMANCE (GPSMAP 135 Sounder)

Receiver:	12-channel PhaseTrac12
Acquisition Time:	Approx. 15 seconds (warm) Approx. 45 seconds (cold) Approx. 5 minutes (AutoLocate™) Approx. 5 minutes (Search the sky)
Update Rate:	1/second, continuous
Position Accuracy:	1-5 meters (3-16 ft.)* 15 meters (49 ft.) RMS**
Velocity Accuracy:	0.1 knot RMS steady state, 999 knots max.
Dynamics:	6g's
Sounder Power Output:	300 WRMS 2400 W peak to peak
Frequency:	200 kHz

POWER

Input:	10-40v DC
Usage:	10 watts max.

Specifications subject to change without notice.

* With optional GARMIN GBR 21 Beacon Receiver Input.

** Subject to accuracy degradation to 100m 2DRMS under the U.S. DOD-imposed Selective Availability Program.

SECTION B

APPENDIX Wiring & Specifications

Note: For transducer specifications, see the booklet included with your transducer.

The GPSMAP 135 Sounder uses an on-screen message prompt to alert you to important information. Whenever a message appears, press the **PAGE** key to view the message.

Alarm Clock—The alarm clock has sounded.

Anchor Drag Alarm—You have drifted out of the specified distance range.

Approaching—You are less than one minute away from reaching a destination waypoint at your present speed over ground.

Arrival At—You have arrived at the destination waypoint.

Can't Change An Active Waypoint—You have attempted to change the 'active to' or 'active from' waypoint. Clear the active route or GOTO before making your changes.

Card Format is Not Recognized—The cartridge inserted is not readable by the GPSMAP 135 Sounder system and may be damaged. Reinsert the cartridge to make sure it is properly installed. If the cartridge is still not recognized, call the G-chart information line at 1-800-427-6460.

Cross-Track Alarm—You have exceeded the off-course distance specified in the CDI setup.

Data Transfer is Complete—The receiver is finished uploading or downloading information to the connected device.

Database Memory has Failed—The built-in 64 nm database has failed. See an authorized service center for repair.

Deep Water Alarm—The current depth is equal to or more than the set alarm depth.

Degraded Accuracy—The accuracy of your GPSMAP 135 Sounder system has been degraded beyond 500 meters due to poor satellite geometry or data quality. You should check

other navigational sources to verify the position indicated.

Max Calibration Is 5000mt (16,400 ft)—You have exceeded the maximum possible map calibration.

Memory Battery Power is Low—The internal battery that stores waypoints, routes and track plots needs to be replaced. Take your unit to an authorized GARMIN service center for installation of a new battery.

Need Altitude—Your GPSMAP 135 Sounder system needs the altitude to maintain a position fix due to poor satellite coverage. Enter your approximate altitude on the initialize position page.

Need to Select Init Method—The GPSMAP 135 Sounder needs to be initialized to your present position. See pages 1-2 for complete instructions on initialization.

No Differential GPS Position—Not enough data is being received to compute a DGPS position.

Oscillator Needs Adjustment—The GPSMAP 135 Sounder has detected excessive drift in its internal oscillator, which may result in longer acquisition times. Take the unit to an authorized GARMIN service center for adjustment.

Poor GPS Coverage—The GPSMAP 135 Sounder cannot acquire the necessary number of satellites to compute a position.

Power Down and Re-init—The GPSMAP 135 Sounder cannot calculate a position due to abnormal satellite conditions. Power down and verify the last position shown by other means.

Proximity Alarm—You have entered the alarm radius for the proximity waypoint indicated.

Proximity List Full—You have used all nine proximity waypoints.

Proximity Overlaps Another Prox Wypt—The alarm radius specified overlaps the area specified for another proximity waypoint. (See section 10 for more information on proximity overlaps.)

RAM has Failed—The random access memory has failed and the unit is not operable. Take your unit to an authorized GARMIN service center for repairs.

ROM has Failed—The unit's permanent memory has failed and the unit is not operable. Take your unit to an authorized GARMIN service center for repairs.

Received Invalid Waypoint—A waypoint was received during upload transfer that has an invalid identifier.

Receiver has Failed—A failure in receiver hardware has been detected. If this message persists, do not use the unit and take it to an authorized dealer for repair.

Route Already Exists—The route number you are trying to copy to is already used.

Route Does Not Exist—The route number you are trying to use or copy is not defined.

Route is Full—You have attempted to add more than 30 waypoints to a route.

Route Memory is Full—You have attempted to create more than 20 routes.

Route Waypoint was Deleted—A route waypoint entered does not exist in the database and has been deleted from the route.

RTCM Input has Failed—DGPS data being received has been lost. You are no longer receiving the beacon signal.

Searching the Sky—The GPSMAP 135 Sounder is searching the sky for almanac data.

Shallow Water Alarm—The depth is equal to or less than the set alarm depth.

Sonar ASIC has Failed—The unit's internal monitoring system indicates a malfunction. Send in for service as soon as possible.

Stored Data was Lost—All waypoints, routes and almanac data has been lost due to internal battery failure.

There is No RTCM Input—The beacon receiver is not properly connected or baud rates do not match.

Timer Has Expired—The countdown timer has expired.

Track Memory is Full—The track memory is full and no additional track plot will be recorded until the track memory has been cleared or set to wrap mode.

Transducer-Sounder Turned Off—The transducer signal is not reaching the unit because of a loose connector, bad wiring, or transducer malfunction.

Wypt Already Exists—The waypoint name you've entered already exists in memory.

Waypoint Memory is Full—You have used all 250 waypoints in the GPSMAP 135 Sounder system.

SECTION D

APPENDIX Map Datums

The GPSMAP 135 Sounder's built-in worldwide database includes chart coverage down to 64 nm (120 km) for the areas outlined above. Note that the database is only valid to 68°15' of latitude. The maximum cursor latitude is 85°05', and the maximum waypoint latitude is 89°24.543 north or south.

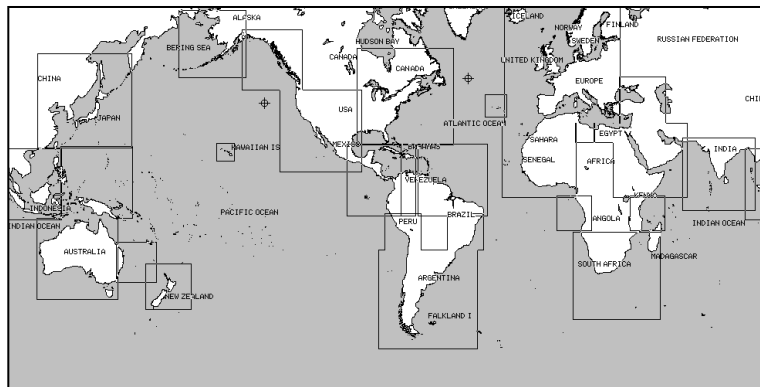

Adindan	Adindan- Ethiopia, Mali, Senegal, Sudan	Astrln Geod '84	Australian Geod '84- Australia, Tasmania Island
Afgooye	Afgooye- Somalia	Austria	Austria
AIN EL ABD '70	AIN EL ANBD 1970- Bahrain Island, Saudi Arabia	Bellevue (IGN)	Efate and Erromango Islands
Anna I Ast '65	Anna I Astro '65- Cocos I.	Bermuda 1957	Bermuda 1957- Bermuda Islands
ARC 1950	ARC 1950- Botswana, Lesotho, Malawi, Swaziland, Zaire, Zambia, Zimbabwe	Bogata Observ	Bogata Observatry- Colombia
ARC 1960	Kenya, Tanzania	Campo Inchspe	Campo Inchauspe- Argentina
Ascnsn Isld '58	Ascension Island '58- Ascension Island	Canton Ast '66	Canton Astro 1966- Phoenix Islands
Astro B4 Sorol	Sorol Atoll- Tern Island	Cape	Cape- South Africa
Astro Bcn "E"	Astro Beacon "E"- Iwo Jima	Cape Canavrl	Cape Canaveral- Florida, Bahama Islands
Astro Dos 71/4	Astro Dos 71/4- St. Helena	Carthage	Carthage- Tunisia
Astr Stn '52	Astronomic Stn '52- Marcus Island	CH-1903	CH 1903- Switzerland
Astrln Geod '66	Australian Geod '66- Australia, Tasmania Island	Chatham 1971	Chatham 1971- Chatham Island (New Zealand)
		Chua Astro	Chua Astro- Paraguay

**Corrego Alegre
Jakarta**

Dos 1968

**Easter Isld 67
European 1950**

European 1979

**Finland Hayfrd
Gandajika Base**

Geod Datm '49

**Guam 1963
Gux I Astro**

**Hjorsey 1955
Hong Kong '63**

**Hu-Tzu-Shan
Indian Bngldsh**

**Indian Thailand
Indonesia '74**

**Ireland 1965
ISTS 073 Astro**

**Johnston Island
Kandawala**

Corrego Alegre- Brazil
Jakarta (Batavia)- Sumatra
Island (Indonesia)

Dos 1968- Gizo Island
(New Georgia Islands)

Easter Island 1967
European 1950- Austria,
Belgium, Denmark,
Finland, France, Germany,
Gibraltar, Greece, Italy,
Luxembourg, Netherlands,
Norway, Portugal, Spain,
Sweden, Switzerland

European 1979- Austria,
Finland, Netherlands,
Norway, Spain, Sweden,
Switzerland

Finland Hayford- Finland
Gandajika Base- Republic
of Maldives

Geodetic Datum '49-
New Zealand

Guam 1963- Guam Island
Guadalcanal Island

Hjorsey 1955- Iceland
Hong Kong

Taiwan
Indian- Bangladesh, India,
Nepal

Indian- Thailand, Vietnam
Indonesia '74

Ireland 1965- Ireland
ISTS 073 ASTRO '69-
Diego Garcia

Johnston Island Kandawala
Kandawala- Sri Lanka
Sri-Lanka

**Kerguelen Isld
Kertau 1948
L. C. 5 Astro
Liberia 1964
Luzon Mindanao
Luzon Philippine**

**Mahe 1971
Marco Astro
Massawa
Merchich
Midway Ast '61
Minna
NAD27 Alaska**

NAD27 Bahamas

NAD27 Canada

NAD27 Canal Zone

NAD27 Caribbean

NAD27 Central

NAD27 CONUS

NAD27 Cuba

Kerguelen Island
West Malaysia, Singapore
Cayman Brac Island
Liberia 1964- Liberia
Luzon- Mindanao Island
Luzon- Philippines
(excluding Mindanao Isl.)
Mahe 1971- Mahe Island
Marco Astro- Salvage Isl.
Massawa- Eritrea (Ethiopia)
Merchich- Morocco
Midway Astro '61- Midway
Minna- Nigeria
North American 1927-
Alaska

North American 1927-
Bahamas (excluding San
Salvador Island)

North American 1927-
Canada and Newfoundland
North Am. 1927- Canal
Zone

North American 1927-
Caribbean (Barbados,
Caicos Islands, Cuba,
Dom. Rep., Grd. Cayman,
Jamaica, Leeward and
Turks Islands)

North American 1927-
Central America (Belize,
Costa Rica, El Salvador,
Guatemala, Honduras,
Nicaragua)

North Am. 1927- Mean
Value (CONUS)

North American 1927-
Cuba

**APPENDIX
Map Datums**

**SECTION
D**

SECTION

D

APPENDIX

Map Datums

NAD27 Greenland	North American 1927- Greenland (Hayes Peninsula)	Rome 1940 RT 90	Rome 1940- Sardinia Isl. Sweden
NAD27 Mexico	N. American 1927- Mexico	Santo (Dos)	Santo (Dos)- Espirito Santo
NAD27 San Salvadr	North American 1927- San Salvador Island	Sao Braz	Sao Braz- Sao Miguel, Santa Maria Islands
NAD83	North American 1983- Alaska, Canada, Central America, CONUS, Mexico	Sapper Hill '43	Sapper Hill 1943- East Falkland Island
Nahrwn Masirah lnd	Nahrwn- Masirah Island (Oman)	Schwarzeck	Schwarzeck- Namibia
Nahrwn Saudi Arbia	Nahrwn- Saudi Arabia	South American '69	S. American '69- Argentina, Bolivia, Brazil, Chile, Colombia, Ecuador, Guyana, Paraguay, Peru, Venezuela, Trin/Tobago
Nahrwn United Arab	Nahrwn- United Arab Emirates	South Asia	South Asia- Singapore
Naparima BWI	Naparima BWI- Trinidad and Tobago	Southeast Base	Southeast Base- Porto Santo and Madiera Islands
Obsrvtorio '66	Observatorio 1966- Corvo and Flores Islands (Azores)	Southwest Base	Southwest Base- Faial, Graciosa, Pico, Sao Jorge and Terceira Islands
Old Egyptian	Old Egyptian- Egypt	Timbalai 1948	Timbalai 1948- Brunei and E. Malaysia (Sarawak and Sabah)
Old Hawaiian	Old Hawaiian- Mean Value	Tokyo	Tokyo- Japan, Korea, Okinawa
Oman	Oman- Oman	Tristan Astro '68	Tristan Astro 1968- Tristan da Cunha
Ord Srvy Grt Britn	Old Survey Grt Britn- England, Isle of Man, Scotland, Shetland Isl., Wales	Viti Levu 1916	Viti Levu 1916- Viti Levu/ Fiji Islands
Pico De Las Nieves	Canary Islands	Wake-Eniwetok	Wake-Eniwetok- Marshall
Potsdam	Germany	WGS 72	World Geodetic System 72
Pitcairn Astro '67	Pitcairn Astro '67- Pitcairn	WGS 84	World Geodetic System 84
Prov So Amrcn '56	Prov So Amrcn '56- Bolivia, Chile, Colombia, Ecuador, Guyana, Peru, Venezuela	Zanderij	Zanderij- Surinam
Prov So Chilean '63	So Chilean '63- S. Chile		
Puerto Rico	Puerto Rico & Virgin Isl.		
Qatar National	Qatar National- Qatar		
Qornoq	Qornoq- South Greenland		
Reunion	Reunion- Mascarene Island		

Almanac Data—The satellite constellation information (including location and health of satellites) that is transmitted to your receiver from every GPS satellite. Almanac data must be acquired before GPS navigation can begin.

Bearing (BRG)—The compass direction from your position to a destination.

Course Over Ground (COG)—Direction of movement relative to a ground position.

Crosstrack Error (XTK)—The distance you are off a desired course in either direction.

Desired Track (DTK)—The compass course between the 'from' and 'to' waypoints.

Differential GPS (DGPS)—An extension of the GPS system that uses land-based radio beacons to transmit position corrections to GPS receivers.

Estimated Time of Arrival (ETA)—The time of day of your arrival at a destination.

Estimated Time Enroute (ETE)—The time remaining to your destination at your present speed.

Grid—A coordinate system that projects the earth on a flat surface, using square zones for position measurements.

Ground Speed (SOG)—The velocity you are traveling relative to a ground position.

Latitude—A north/south measurement of position perpendicular to the earth's polar axis.

Longitude—An east/west measurement of position in relation to the Prime Meridian, an imaginary circle that passes through the north and south poles.

Position—An exact, unique location based on a geographic coordinate system.

Sensitivity—A measure of how sensitive the sounder is to sonar echoes.

Speed Through Water (STW)—The speed you are traveling relative to the water's surface.

SECTION E

APPENDIX Glossary

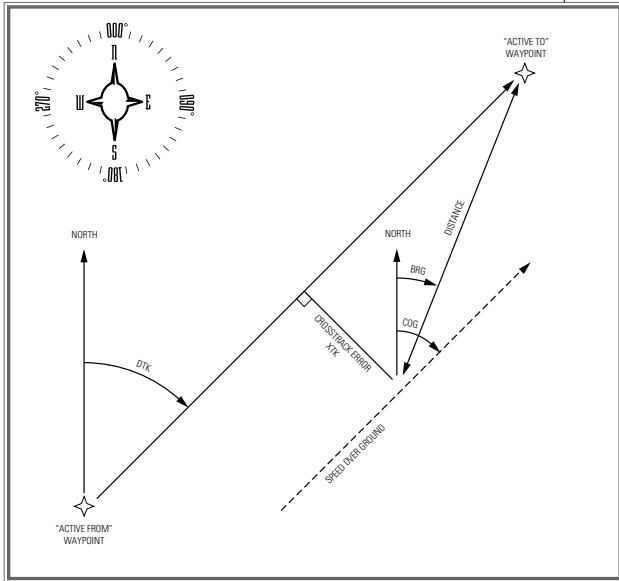

Thermocline— A layer of water separating warmer water above from cooler water below.

Turn (TRN)— The difference and direction in degrees between the bearing to your destination and your course over ground. The TRN value is used to indicate what direction, and how many degrees, to turn to get back on course.

Universal Time Coordinated (UTC)— The time of day at the prime meridian (0° longitude) in Greenwich, England.

Universal Transverse Mercator- (UTM)— A grid coordinate system that projects global sections onto a flat surface to measure position in specific zones.

Velocity Made Good (VMG)—The speed you are traveling in the direction of the destination.

Waypoint—A specific location saved in the receiver's memory.

Whiteline—A term applied to the portion of the sonar display which shows the area of strongest sonar return (typically the bottom).

The chart below gives an approximate UTC time offset for the various longitudinal zones. Check with local charts for more detailed information. If you are in daylight savings time, add one hour to the offset.

Longitudinal Zone	Offset
W180.0° to W172.5°	-12
W172.5° to W157.5°	-11
W157.5° to W142.5°	-10
W142.5° to W127.5°	-9
W127.5° to W112.5°	-8
W112.5° to W097.5°	-7
W097.5° to W082.5°	-6
W082.5° to W067.5°	-5
W067.5° to W052.5°	-4
W052.5° to W037.5°	-3
W037.5° to W022.5°	-2
W022.5° to W007.5°	-1
W007.5° to E007.5°	0
E007.5° to E022.5°	1
E022.5° to E037.5°	2
E037.5° to E052.5°	3
E052.5° to E067.5°	4
E067.5° to E082.5°	5
E082.5° to E097.5°	6
E097.5° to E112.5°	7
E112.5° to E127.5°	8
E127.5° to E142.5°	9
E142.5° to E157.5°	10
E157.5° to E172.5°	11
E172.5° to E180.0°	12

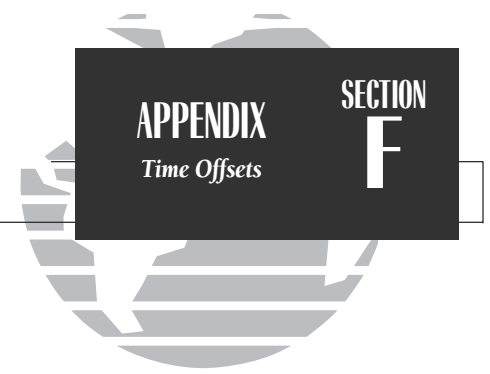

SECTION
G

APPENDIX
Index

A		Definitions	93-94
Alarm Setup	77	Desired Track (DTK)	93
Anchor Drag Alarm	77	Depth Contours	75
Antenna Installation	82	Depth Units	75
Arrival Alarm	77	Dilution of Precision (DOP)	21
AutoLocate	1,21-22	DGPS Setup	78-79
		DGPS Status	21
B		E	
Backlight Level	3	Entering Initial Position	2,22
Beacon Receiver Setup	78-79	Estimated Position Error (EPE)	21
Bearing	93	Estimated Time of Arrival (ETA)	45,93
Bearing/Distance Calculation	40	Estimated Time Enroute (ETE)	45,93
Boat Icon	10		
Built-in Map Coverage	2,90	F	
C		Ferrite Clamps	85
Calibrations, Map	42	Full Page Mapping	41
Cancelling Active GOTOs	59	G	
Capabilities	iii	G-chart Cartridges	80-81
Cautions	ii	GOTO Key	12,58-59
Clock Alarm	62	Ground Speed	93
Configurations, Map	41-42	H	
Contrast Setting	3,74	Heading Selection	75-76
Countdown Timer	77	Highway Scale	16,46
Course Deviation Indicator (CDI)	16	I	
CDI Scales	36,76	Initialization	1-2
Crosstrack Error	93	Installation	82-85
Cursor Mode	37-38	Interface Options	78
Cursor Movement	11,38	Interface Setup	78-79
D		Interval, Track Storage	70
Data Field Entry	13		
Data Window	62		
Date/Time Formats	74		
Datums	90-92		

K		P	
Keypad Tone	74	Packing List	vi
Keypad Usage	viii	Page Sequence	5
L		Physical Specifications	87
Local Time Offset	74	Point-to-Point Planning	71
M		Position Format	75
Magnetic Variation	75-76	Position Mode	37
Main Menu	48	Position Page	23-24
Man Overboard Function	60	Velocity Filters	76
Map Calibration	42	Power Off	19
Map Configuration	41-42	Power On	1
Map Datum List	90-92	Proximity Alarm	56
Map Datum Selection	76		
Map Page	36-44	R	
Map Scales	39	Removing G-chart Cartridges	80
Map/Sounder Split Screen	29,43	Routes	62-69
Marking a Position	6,49-50	Activating A Route	65
Measuring Bearing & Distance	40	Active Route Page	17,68-69
Menu Selection	18	Clearing	67
Message Descriptions	88-89	Copying	67
Messages, Viewing	1	Creating	62
		Deactivating	65,67,69
N		Editing By Text	64-65
Navigation Page	15-16,45-47	Editing Graphically	63
Navigation Setup	46-47	Modifying Route Waypoints	63-65
Navigation Units	75	Modifying Routes	63-67
NMEA Formats	86	Moving Route Waypoints	63
NMEA Setup	78-79	Removing Route Waypoints	65
No Map Mode	39	Reviewing Routes	63
		Route Comments	66
O		Route Planning Mode	72
Offset, local time	64,81	Stopping Route Navigation	17
Operation Setup	73-75		
Overzoom Mode	39	S	
		Satellite Acquisition	2,20-21

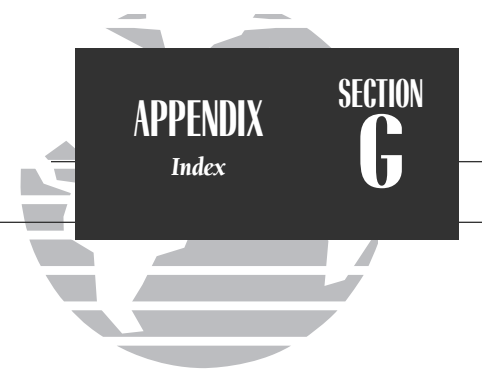

SECTION
G

APPENDIX
Index

Satellite Sky View	20	Track Log	70
Signal Strength Bars	2,20	Track Memory	70
Simulator Mode	4	Track Plot Resolution	70
Simulator Tour	4-19	Track Recording	70
Sounder Page	7-9,25-35	Trip Odometer	23-24
Chart Speed	30	Turn (TRN)	31,47,94
Fish Id	32		
Keel Offset	33	U	
Map/Sounder Split Screen	29,43	Units of Measure	75
Noise Rejection	33	UTC time	74,95
Range Modes	25,30	UTM/UPS Coordinates	95
Auto	25-26		
Manual	25-26	V	
Window	25,31	Velocity Filter	76
Sensitivity	30,93	Velocity Made Good (VMG)	31,47,94
Sounder Setup	32-35		
Speed Calibration	33-35	W	
Thermocline	7,25,94	Waypoints	49-57
Transducer	vii,7,25,84	Active Waypoints	68
Underwater Waypoint	7-8,28-29	Creating	49-52
Water Type	33	Deleting	54
Whiteline	7,25,30,94	Editing By Text	53
Zoom Function	9,27-28	Editing Graphically	54
Zoom Window Movement	28	Modifying	53-55
Status Bar	3	Moving Route Waypoints	63
Status Page	20-22	Nearest Waypoints	55
Steering Guidance	16,45-47	Proximity Waypoints	56
Sunrise/Sunset Calculation	73	Reference Waypoints	52
		Removing Route Waypoints	65
T		Renaming	54
Table of Contents	vii	Reviewing	53
Time Offsets	73-74,95	Submenus	55
Timer/Alarm Setup	77	Underwater Waypoints	7-8,28-29
Tone Selection	74	Waypoint List	57
TracBack Function	60-61	Wiring Installation	96



© 1997 GARMIN Corporation

1200 E. 151st Street, Olathe, KS 66062 USA

GARMIN (Europe) LTD Unit 5, The Quadrangle, Abbey Park Industrial Estate, Romsey SO51 9AQ UK

Part Number 190-00107-00 Rev. C Printed in Taiwan