

GPS 120XL

MARINE NAVIGATOR



OWNER'S MANUAL
&
REFERENCE



Software Version 2.0 or above

© 1997 GARMIN Corporation
1200 E. 151st Street, Olathe, KS USA 66062
Tel: 913-397-8200 or 800-800-1020
Fax: 913-397-8282
Web Site Address: www.garmin.com

GARMIN (Europe) Ltd.
Unit 5,
The Quadrangle, Abbey Park Industrial Estate,
Romsey, SO51 9AQ, U.K.
Tel: 011-44-1794-519944
Fax: 011-44-1794-519222

GARMIN (Asia) Corp.
4th Fl., No. 1., Lane 45,
Pao-Hsing Road,
Hsin Tein,
Taiwan R.O.C.
Phone: 886.02.917.3773
Fax: 886.02.917.1758

All rights reserved. No part of this manual may be reproduced or transmitted in any form or by any means, electronic or manual, including photocopying and recording, for any purpose without the express written permission of GARMIN.

Information in this document is subject to change without notice. GARMIN reserves the right to change or improve its products and to make changes in the content without obligation to notify any person or organization of such changes or improvements.

GARMIN, Personal Navigator, AutoLocate, TracBack, and MultiTrac 8 are all trademarks of GARMIN Corporation and may not be used without the expressed permission of GARMIN.

GPS 120XL OPERATOR'S MANUAL

Welcome to the easiest-to-use fixed-mount GPS on the water!
The GPS 120XL represents GARMIN's continuing commitment to provide mariners with quality navigation information in a versatile, accurate and user-friendly design which will be useful for years to come. To get the most from your new GPS unit, it is important that you take the time to read through the operator's manual to understand the operating features of the GPS 120XL. The manual is organized into four sections for your convenience:

Introduction gives a quick overview of the manual and contains the table of contents and glossary of navigation terms.

Getting Started takes you through step-by-step instructions to initialize the receiver for first-time use and introduces you to the basic features of the unit with a quick-start orientation to the GPS 120XL. This section has been designed to acquaint you with the unit and provide a basic working knowledge necessary to use the unit in typical conditions.

Reference provides detailed explanations of the advanced features and operations of the GPS 120XL in a topical format. This allows you to concentrate on a specific topic quickly, without reading through entire sections of text that you may not need.

The **Appendix** section contains installation instructions and items with multiple listings, such as: map datams, time offsets, and the index.

Packing List

Before getting started with your GPS receiver, check to see that your GARMIN GPS 120XL package contains the following items. If you are missing any parts, please contact your dealer immediately.

Standard Package:

- GPS 120XL Unit
- External Antenna with 30' cable
- Power/Data Cable
- Mounting Bracket with knobs
- Owner's Manual
- Quick Reference Card

See your GARMIN dealer for accessories, including our PC kit.

Thanks for choosing the GARMIN GPS 120XL. We hope it will help you meet all of your navigation needs.



Caution

The GPS system is operated by the government of the United States, which is solely responsible for its accuracy and maintenance. The system is subject to changes which could affect the accuracy and performance of all GPS equipment. Although the GPS 120XL is a precision electronic NAVigation AID (NAVAID), any NAVAID can be misused or misinterpreted and, therefore, become unsafe.

Use the GPS 120XL at your own risk. To reduce the risk of unsafe operation, carefully review and understand all aspects of this Operator's Manual and thoroughly practice operation using the simulator mode prior to actual use. When in actual use, carefully compare indications from the GPS 120XL to all available navigation sources including the information from other NAVAIDs, visual sightings, maps, etc. For safety, always resolve any discrepancies before continuing navigation.

NOTE: This device meets requirements for Part 15 of the FCC limits for Class B digital devices for home or office use. It has been tested for compliance with all necessary FCC standards. This equipment generates, uses, and can radiate radio frequency energy and, if not installed and used in accordance with the instructions, may cause harmful interference to radio communications. However, there is no guarantee that interference will not occur in a particular installation. If this equipment does cause harmful interference to other equipment, which can be determined by turning the equipment off and on, the user is encouraged to try and correct the interference by relocating the equipment or connecting the equipment to a different circuit than the affected equipment. Consult an authorized dealer or other qualified service technician for additional help if these remedies do not correct the problem. Operation is subject to the following conditions: (1) This device cannot cause harmful interference, and (2) this device must accept any interference received, including interference that may cause undesired operation. The GPS 120XL does not contain any user-serviceable parts. Repairs should only be made by an authorized service center. Unauthorized repairs or modifications could void your warranty and your authority to operate this device under Part 15 regulations.

Table of Contents

SECTION ONE Introduction

Glossary/Navigation Basics	2-4
----------------------------------	-----

SECTION TWO Getting Started

Turning On and Initializing the Receiver	5-7
Primary Page Overview	8-9
Marking a Position	10-11
Position and Map Page Basics	11-12
Going To a Waypoint	13
Using the Highway Page	14
Cancelling a GOTO and Clearing Maps	15

SECTION THREE Reference

Satellite Page	16-17
Position Page	18
Marking, Saving, and Using Waypoints	19-26
TracBack Navigation	27-28
Creating and Using Routes	29-34
Using the Compass and Highway Navigation Pages	35-37
Map Plotting, Zooming, and Cursor Movement	38-40
Menu Page and Distance/Sun Calculation	41
Track Log Setup and TracBack	42
Interface Setup and DGPS Interface	43-45
System Setup	46-47
Navigation Setup	48-50
Map Page Setup	51-52
Alarms Setup	53
Navigation Simulator	54
Appendix A—Unit and Antenna Installation	55-57
Appendix B—Specifications and Wiring	58-59
Appendix C—Messages/Time Offsets	60-61
Appendix D—Map Datums	62-64
Appendix E—Index	65-66

Glossary

The GPS 120XL is a powerful navigation tool that can guide you anywhere in the world. To better understand its operation and capabilities, it may be helpful to review the basic terms and concepts briefly explained below.

Other navigation and GPS definitions used in the manual are defined in the appropriate reference sections of the manual.

Almanac Data

Satellite constellation information (including location and health of satellites) that is transmitted to your receiver from every GPS satellite. Almanac data must be acquired before GPS navigation can begin.

Bearing

The compass direction from your position to a destination.

Course Made Good (CMG)

The bearing from the “active from” position (your starting point) to your present position.

Crosstrack Error (XTE)

The distance you are off a desired course in either direction.

Desired Track (DTK)

The compass course between the “from” and “to” waypoints.

Differential GPS (DGPS)

An extension of the GPS system that uses land-based radio beacons to transmit position corrections to GPS receivers.

Estimated Time of Arrival (ETA)

The time of day of your arrival at a destination.

Estimated Time Enroute (ETE)

The time left to your destination at your present speed.

Grid

Coordinate system that projects the earth on a flat surface, using square zones for position measurements. UTM/UPS and Maidenhead formats are grid systems.

Ground Speed

The velocity you are traveling relative to a ground position.

Latitude

The north/south measurement of position perpendicular to the earth's polar axis.

Longitude

An east/west measurement of position in relation to the Prime Meridian, an imaginary circle that passes through the north and south poles.

Navigation

The process of traveling from one place to another and knowing where you are in relation to your desired course.

Position

An exact, unique location based on a geographic coordinate system.

Track (TRK)

The direction of movement relative to a ground position.

Universal Transverse Mercator (UTM)

A grid coordinate system that projects global sections onto a flat surface to measure position in specific zones.

Velocity Made Good (VMG)

The speed you are traveling in the direction of the destination.

Waypoint

A specific location saved in the receiver's memory.

Navigation
Basics

The GPS 120XL provides steering guidance and navigation information using degrees, a measurement measured in a clockwise direction from a north reference. North is described as 000°, east as 090°, south as 180°, and west as 270°. The diagram and compass rose below provide a graphic illustration of the navigation terms used by the GPS 120XL. More information on basic navigation and GPS are available at your local library or bookstore.

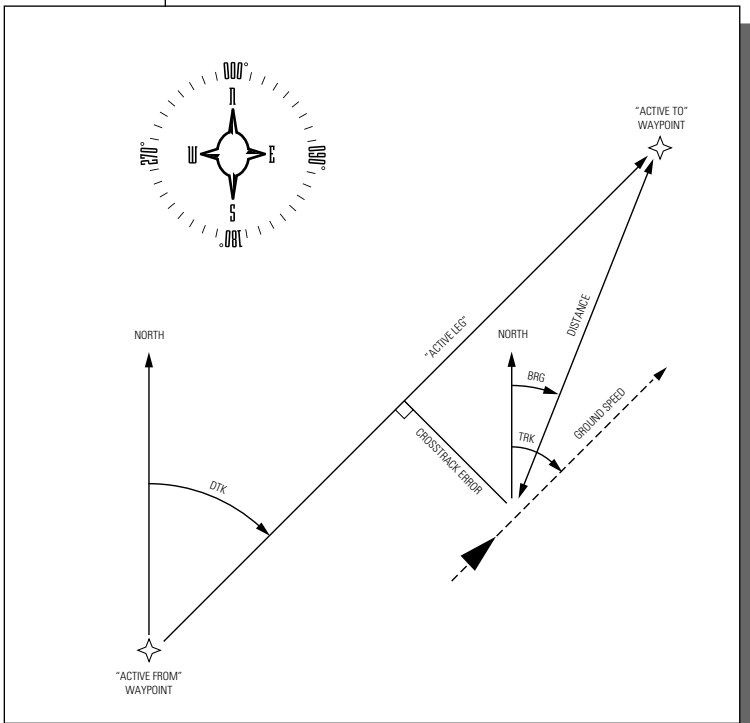

Getting Started with your GPS

Welcome to the exciting world of GARMIN GPS! The GPS 120XL represents GARMIN's continuing commitment to provide marine users with quality navigation information in a versatile, user-friendly design they will enjoy for years to come. To get the most out of your GPS receiver, be sure to read through the initialization and Getting Started sections of this manual, and refer to the reference section for complete details on the GPS 120XL's advanced features.

Initializing Your GPS for First-Time Use

The first time you power up your new GPS 120XL is an important step in getting the best possible future GPS performance.

Because a GPS receiver can only receive signals from satellites above the horizon, it needs to know what satellites to look for at any given time. By using an almanac (a timetable of satellite numbers and their orbits) stored in the receiver's memory, the GPS 120XL can determine the distance and position of any GPS satellite and then use this information to determine your position.

To obtain this almanac data, your GPS receiver needs to be initialized -- or given the opportunity to "find itself"-- the very first time it is turned on. Once you have initialized the unit, the GPS 120XL will compute future fixes more rapidly, usually in a few minutes.

Remember that initializing the unit is only necessary under the following conditions:

- First-time use from the factory
- If the receiver has been moved over 500 miles from the last calculated position with power off
- If the receiver's memory has been cleared and all stored data has been lost



Welcome Page

The welcome page will appear as soon as the GPS 120XL is turned on and remain while the unit conducts a brief self-test.

Initialization



The EZinit prompt will automatically appear if the receiver needs to be initialized. The prompt may also appear during normal use if the antenna is shaded.



Use the arrow keypad to highlight the country, region or state of your present position from the list and press ENTER. If the country is not listed, select the closest country instead.

Initializing the Receiver

The receiver is shipped from the factory in AutoLocate™ mode, which enables the GPS 120XL to determine its location anywhere in the world. To speed up the initialization process, we recommend using the graphic initialization described below, which will usually provide a fix in 7.5 to 15 minutes.

Before you initialize, make sure your GPS 120XL unit and antenna have been correctly installed on your boat according to the instructions in Appendix A.

To turn the GPS 120XL on:

1. Press and hold  until the receiver turns on.

The welcome page will be displayed while the unit conducts a self test.

Once testing is complete, the welcome page will be replaced by the Satellite Page, with the EZinit prompt ready for you to select one of two initialization methods:



- **Select Country**—allows you to initialize the receiver by selecting your present position from a list of countries in the GPS 120XL's internal database. This usually provides a position fix in a few minutes.
- **Autolocate™**—allows the GPS 120XL to initialize itself and calculate a position fix without knowing your present position. This usually provides a position fix in 7.5-15 minutes.

If the EZinit prompt has not automatically appeared on the Satellite Page:

1. Press the  key.

Note: If the EZinit prompt ever appears after you have initialized the receiver (due to the antenna's view of satellites being obstructed by trees, etc.), highlight the 'no re-init' selection with the arrow keypad and press ENTER.

To initialize the receiver:

1. If the 'country' option is not highlighted, press the  key repeatedly to move the field highlight to the 'country' option.
2. Press the  key.

Initialization

Initializing the Receiver (cont)

- Use the ▼ key to scroll through the list options until the country of your present position appears.
- Use the ▲ key to highlight the country/state/region you're in. If the country you're in is not listed, select another country within 500 miles of your present position.
- Press **ENTER** to finish.

The GPS 120XL will now begin searching for the appropriate satellites for your location and should acquire a position within 3-5 minutes. You can verify that you have acquired a position by watching the Satellite Page transition to the Position Page (provided you haven't pressed any other buttons) or by looking for a '2D NAV' or '3D NAV' status at the top left corner of the Satellite Page.

Initialization Troubleshooting

If you have trouble initializing the receiver or acquiring a position, check the following:

- **Does the antenna have a clear view of the sky?**

If there are large buildings or mountains nearby, or if there is heavy tree cover, the receiver may not be receiving enough satellite signals to calculate a position.

- **Have you selected the right country/state/region from the EZinit list?**

Check for the correct approximate lat/lon on the Position Page, or reselect the appropriate country from the list to restart the initialization.

- **Have you moved more than 500 miles from the last calculated position with the receiver off?**

Reinitialize the receiver, selecting the country/state/region of your new location from the EZinit list.

Your unit should now be initialized. If you want to complete the Getting Started Tour at another time, you may now turn the GPS 120XL off (see below) or you may continue.

To turn the GPS 120XL off:

- Press and hold **OFF** for approximately three seconds until the receiver turns off.

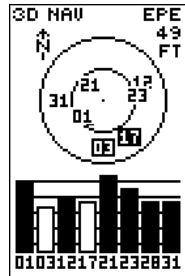

The GPS 120XL's Satellite Page will help you determine which satellites are in view and whether or not any satellites are being "shaded" or blocked from the receiver's antenna.

By monitoring the signal strength bars at the bottom of the page and the sky view, you'll be able to see how moving to another area with a clearer view of the sky will improve satellite reception and speed up signal acquisition.

GETTING STARTED

Primary Pages

Primary Pages

Before we start the tour, let's briefly look at the five primary information pages used for the GPS 120XL. Note: Switch between pages by pressing either the **QUIT** or **PAGE** keys.

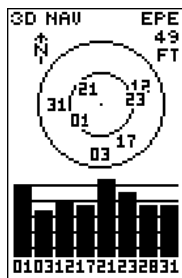
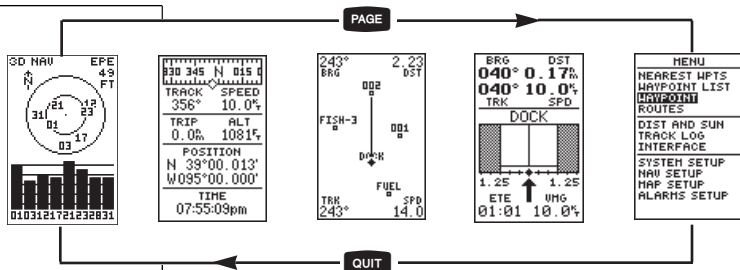

Satellite Page

The Satellite Page will allow you to monitor satellite signal reception and strength.

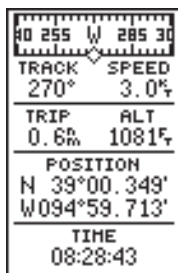

Position Page

Satellite Page

The **Satellite Page** shows satellite positions and signal strength. Satellite positions are displayed using two circles and a center point. The outer circle shows satellites on level with the horizon; the inner circle is 45° above the horizon; and the center point represents satellites directly overhead. Knowing satellite positions will show you the direction of any blocked signals.

The bottom of the page contains a row of signal strength bars corresponding to each satellite being used.

Position Page

The **Position Page** shows you where you are, what direction you're heading and how fast you're going.

The top of the page contains a compass tape which is a graphic representation of your heading. Your track and speed are indicated immediately below.



The graphic compass tape reflects your heading only while you are moving.

The rest of the page shows your current position in three dimensions: latitude, longitude and altitude. A trip odometer and 12/24 hour clock are also provided.

Map, Navigation
& Menu Pages**Map Page**

The **Map Page** acts as a window. It allows you to view your position, the “path” you have traveled over, and nearby waypoints.

A diamond icon in the center of the screen represents your current position. As you move, you will see a thin line-- called a *track log*-- appear along the path you have just covered. Names of stored waypoints can also be shown on the map.

The bottom corners of the screen will always display your current track and speed. When going to a waypoint, highlighting an on-screen waypoint, or using the panning target crosshair, the corresponding distance and bearing are shown at the top corners of the screen.

Navigation Page

A navigation page gives you steering guidance when going to a waypoint. The GPS 120XL has two navigation page choices: the Highway Page and the Compass Page. The Highway Page is the default and will be briefly explained here. The Compass Page is covered on pages 35 and 37.

The **Highway Page** uses a graphic highway to show your movement in relation to your desired course. The upper section shows bearing and distance to the waypoint and your current track and speed. The middle portion contains the actual highway. The highway indicates the crosstrack error, or distance and direction, you are off-course from your waypoint. Always turn in the direction the highway is pointing. For example, if the highway points straight up, no turn is required. If the highway points right, you need to turn right until the highway points straight up. The remainder of the page contains the estimated time enroute (ETE) and your velocity made good (VMG).

Menu Page

The last primary page is the **Menu Page**. The Menu Page gives you access to the GPS 120XL's waypoint management, route, track log, and setup features through a list of submenus.

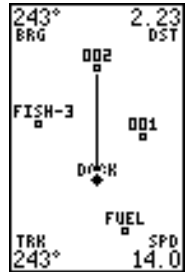
**Map Page**

Shows your progress on a moving track plotter and get a bird's-eye-view of surrounding waypoints with the Map Page.

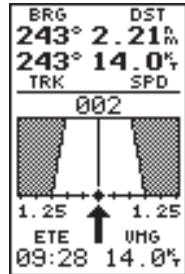
**Highway Page**

With the Highway Page, you will get graphic steering guidance in navigating a route or to a single waypoint.

Marking A Position

SYSTEM SETUP
MODE: Simulator
DATE 22 FEB 97
TIME 07:53:48pm
OFFSET: -06:00
HOURS: 12
CONTRAST: █
TOPE: MSG, Key

The simulator mode will allow you to practice navigation and become familiar with the GPS 120XL without leaving your slip.

GPS POSITION
Waypoint: 001
N 39°00.000'
W 095°00.000'

Add to route number: --
SAVE?

To save a waypoint with the default three-digit name, simply press the MARK key followed by the ENTER key. The GPS 120XL will then return to the page previously displayed.

Getting Started Tour

Now that your GPS receiver has been initialized and you are familiar with the primary pages, it's time to take a tour. This is a live tour and is to be conducted with your unit installed and with the boat in the water. The tour will take you through the receiver's basic features and functions as you move about on the water and assumes that the GPS 120XL is turned on, initialized, and that you have not changed any of the factory settings (units of measure, selectable fields, etc.). If these settings have been changed, the pictures and descriptions in this manual may not match what you see on your screen.

Navigation Simulator

If you are not able to take the Getting Started Tour with your boat in the water, you may use the built-in navigation simulator to practice using the GPS 120XL. To use the simulator, see page 54.

Marking a Waypoint

To begin the tour, let's take the position you have acquired (either by just initializing the unit or by having turned the unit on) and mark it as a waypoint for future reference.

1. Press the **MARK** key to capture and hold your position.



To mark a position, you must have obtained a 2D or 3D fix, or have the receiver in simulator mode. If you try to mark a position without a position fix, you will be alerted with a 'No GPS Position' message.

Marking A Position

The mark position page will appear, showing the captured position and a default 3-digit waypoint name. Let's change the default name to something a little more meaningful, like 'DOCK'.

1. Press the **▲** key twice to move the field highlight from the 'save' field to the name field.
2. Press **ENTER** and **◀** to clear the default waypoint name.
3. Press and hold the **▲** key to scroll through the alphabet until the letter 'D' appears.
4. Press the **▶** key once to move the character highlight to the next character space.
5. Repeat steps 3 and 4 until the word 'DOCK' is displayed.
6. Press **ENTER** to complete entry of the name.
7. Press the **▼** key once to return the field highlight to the 'save' field.
8. Press the **ENTER** key to confirm that you want to save the position as a waypoint named 'DOCK'.

The mark position page will now be replaced by the Position Page (or whatever page was displayed prior to pressing the **MARK** key). The 'DOCK' waypoint is now stored in the GPS 120XL's memory, and will remain there until you manually remove it or clear the receiver's memory. For more on waypoint management, see pages 19-25.

Using the Position and Map Pages

Now that you've marked a position, let's see how the Position and Map Pages can be used to monitor your progress as you head out in to the open water.



As always, ensure your primary focus is on boating traffic and monitor the GPS120XL briefly when operating your boat.

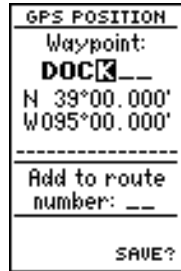

The arrow keypad is used for all data entry. Use the UP and DOWN keys to select letters, numbers, or menu options, and use the LEFT and RIGHT keys to move the cursor forward or backward along the line.

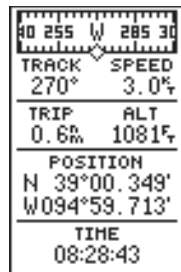

Position Page

GETTING STARTED

Position & Map Pages

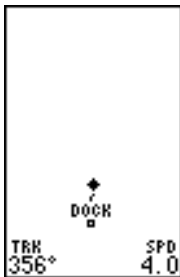

The Map Page displays your present position as a diamond icon and provides real-time graphic "bread-crum" display of your track right on the screen.

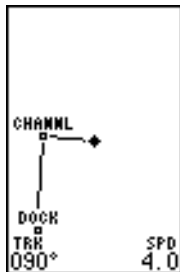

The moving map's default screen orientation is track up orientation. "Track up" means that your current direction of travel is always up (or towards the top of) the screen. It can also be set for north up, or desired track orientation through the map setup page.

Using the Position and Map Pages (continued)

As you head out, the Position Page will help you monitor your movement.

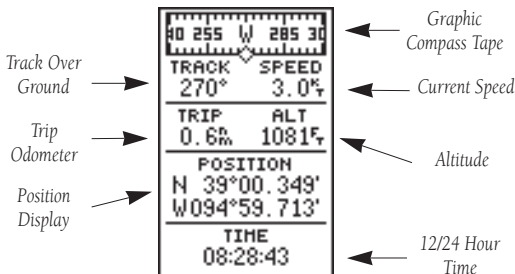

The direction you are moving (your track) and your speed are displayed on the upper part of the page, just below the graphic compass tape. The latitude, longitude and approximate altitude of your position, along with a resettable trip odometer, are continuously displayed in the middle of the page, and the time of day is displayed below.

Now let's change the display to the Map Page and watch the track log of our tour:

1. Press the **PAGE** key to change from the Position Page to the Map Page.

To get a larger view of the Map Page, let's change the zoom scale from .2 (default) to 1.0 nautical mile.

To select a larger zoom scale on the Map Page:

1. Press the **OUT** key until '1.0 n.m. zoom scale' appears.

Your current position is shown as the diamond in the middle of the screen. The dark circle below the diamond represents the position you created, with the line between the two showing your track.

1. Once you have reached an area that allows for general changes in direction without interfering in the passage of other boats, mark your current position again and name this waypoint "CHANNL". (See 'Marking a Waypoint' on pages 10-11)
2. Next, make a moderate turn in any direction safe for navigation and proceed for another 3 minutes.

Going To a Waypoint

Once you've stored the "CHANNL" waypoint in memory, you can use the GPS 120XL to guide you to it by performing a simple GOTO. A GOTO is nothing more than a straight-line course from your present position to the destination you've selected.



Use caution when navigating. A "straight-line" course reflects the shortest distance to a waypoint, and does not navigate around obstructions, such as land or buoys, etc.

Now that you have moved away from 'CHANNL' for three minutes, let's try navigating back to it.

To select a GOTO destination:

1. Press the **GOTO** key.
2. The GOTO waypoint page will appear, displaying all the waypoints in memory in alphabetical order.
3. Use **▲** or **▼** to highlight the 'CHANNL' waypoint.
4. Press the **ENTER** key to confirm that you want to navigate to the displayed waypoint. The Highway Page (default) will appear.

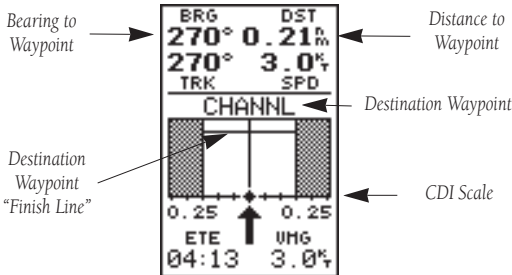

The GPS 120XL's Highway Page provides graphic steering guidance to a destination, with an emphasis on a straight-line course to the desired waypoint and the distance and direction you are off course. The bearing and distance to a waypoint, along with your current track and speed are displayed at the top of the screen, with your estimated time enroute (ETE) and velocity made good (VMG), or the speed you are approaching your destination, shown at the bottom.

Going To A Waypoint



The GOTO waypoint page allows you to select your destination from a list of all available waypoints in the GPS 120XL's memory.



Once a GOTO is activated, the GPS 120XL will provide steering guidance until the GOTO is cancelled. To cancel a GOTO, highlight the cancel prompt at the bottom of the page and press **ENTER**.

GETTING STARTED

Using The Highway Page

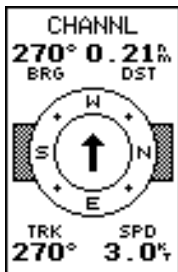

The 120XL will also provide steering guidance with a graphic compass page.

To change the display from the highway page, press ENTER twice.



Once you are one minute from the destination (based on your present speed and course), an arrival message will appear on the message page.

Using the Highway Page (continued)

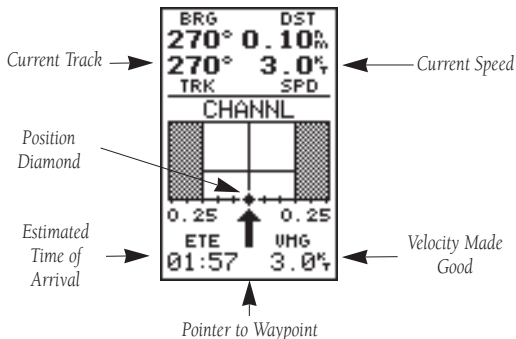

As you head toward your destination, the middle section of the screen provides visual guidance to your waypoint on a moving graphic “highway”. The moving arrow just below the course deviation scale always points to your selected waypoint relative to the direction you are moving.

Your present position is represented by the diamond in the center of the course deviation scale. The line down the middle of the highway represents your desired track. As you navigate toward a waypoint, the highway will actually move, indicating the direction you’re off course, relative to the position diamond on the CDI scale. To stay on course, simply steer toward the center of the highway.

While navigating, you may decide to use the Compass Page (see picture above left) instead of the Highway Page.

To select the Compass Page:

1. While viewing the Highway Page press **ENTER**, twice.

The Compass Page will now become the displayed navigation page. This page provides a directional pointer to your destination, by using a rotating compass display to show direction of travel. It provides better steering guidance at slower speeds for travel with many directional changes.

To switch back to the Highway Page, press ENTER twice.

**Cancelling A
GOTO &
Clearing Maps****Cancelling a GOTO**

If you decide to stop navigating to the active way-point, all you have to do is cancel the GOTO.

To cancel an active GOTO:

1. Press the **GOTO** key.
2. Use the arrow keypad to move the field highlight to the 'CANCEL GOTO?' prompt at the bottom of the page and press **ENTER**.

Clearing a Cluttered Map Display

After you've used the GPS 120XL for a few trips, you may find that your map display has become a bit messy from keeping track of your every move. For practice, let's clean up the screen by clearing the track log (the plot points left on the Map Page) we've just created during the Getting Started Tour.

1. Press **PAGE** or **QUIT** until the Menu Page appears.
2. Use the **▼** key to move the field highlight to the 'TRACK LOG' option.
3. Press **ENTER** to access the track log page.
4. Press the **▲** key twice to highlight the 'CLEAR LOG?' option. The clear log confirmation page will appear.
5. Use the **◀** key to highlight the 'Yes' prompt.
6. Press **ENTER** to finish.

Turning the Receiver Off

You've now gone through the basic operation of your new GPS receiver and probably know a little more than you think about how it works. We encourage you to experiment with the GPS 120XL until it becomes an extension of your own navigation skills. If you encounter any problems using the unit or want to take advantage of the GPS 120XL's more advanced features, refer to the reference section.

To turn the GPS 120XL off:

1. Press and hold the **POWER** key for 3 seconds.

TRACK LOG
RECORD: Yes
CRITERIA: Automatic
MEMORY USED 0 of 768 points (0%)
CLEAR LOG? TRACKBACK?

Highlight the 'CLEAR LOG?' prompt and press **ENTER** to clear the track log. Once all 1024 points are used, the oldest point will be continuously deleted to make room for the latest track log point.



Holding the **POWER** key for three seconds ensures against accidental shut-off by accidentally pressing the button.

Satellite Page
Overview

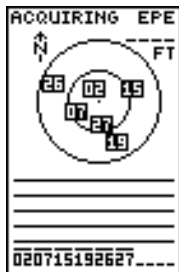

As soon as a satellite has been found and the GPS 120XL is acquiring position data, the satellite number will turn to normal presentation and a hollow bar will appear.

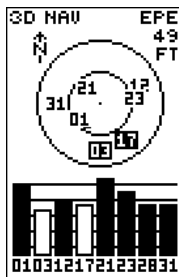

Satellites being tracked but blocked from use (03,17) will be displayed in reverse video, with the corresponding signal strength bar hollow.

Satellite Page

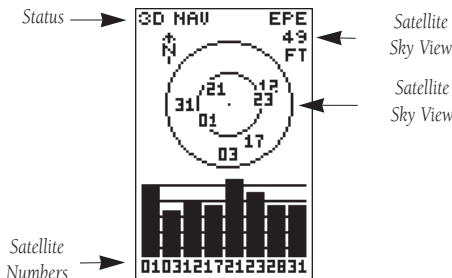

The Satellite Page displays the status of various receiver functions. The status information will help you understand what the GPS 120XL is doing at any given time, and will tell you whether or not the receiver has calculated a position fix.

Sky View and Signal Strength Bars

The sky view and signal strength bars give you an indication of what satellites are visible to the receiver, whether or not they are being used to calculate a position fix, and the signal quality. The sky view in the center of the page shows a bird's-eye view of the position of each satellite relative to the receiver's last known position. The outer circle represents the horizon (north up); the inner circle is 45° above the horizon; and the center point is a position directly overhead.

When the receiver is looking for a particular satellite, the corresponding signal strength bar will be blank and the sky view indicator will remain highlighted in reverse video. Once the receiver has found the satellite, a hollow signal strength bar will appear, indicating that the satellite has been found and the receiver is collecting data from it. The satellite number in the sky view will also change from reverse video to normal presentation. As soon as the GPS 120XL has collected the necessary data to use the satellite for positioning, the hollow bar will become solid.

Receiver Status & EZinit

Receiver Status and EPE

Receiver status is indicated at the top left of the screen, with the current horizontal accuracy (estimated position error, in feet or meters) at the top right. The status will show one of the following conditions:

Searching— the GPS 120XL is looking for any available satellites in view.

AutoLocate™— the GPS 120XL is initializing and collecting new almanac data. This process can take 7.5 to 15 minutes.

Acquiring— the receiver is collecting data from available satellites, but has not collected enough data to calculate a 2D fix.

2D Nav (2D Navigation)— at least three satellites with good geometry have been locked onto and a 2-dimensional position fix (latitude and longitude) is being calculated. '2D Diff' will appear when you are receiving DGPS corrections in 2D mode.

3D Nav (3D Navigation)— at least four satellites with good geometry have been locked onto, and your position is now being calculated in latitude, longitude and altitude. '3D Diff' will appear when you are receiving DGPS corrections in 3D mode.

Poor CVG (Poor GPS Coverage)— the receiver is no longer tracking enough satellites for a 2D or 3D fix.

Not Usable— the receiver is unusable, possibly due to incorrect initialization or abnormal satellite conditions. Turn the unit off and back on to reset.

SIM (Simulating Navigation)— the receiver is in simulator mode.

EZinit Option Prompt

The Satellite Page also provides access to the GPS 120XL's initialization menu, the EZinit prompt. The EZinit prompt will appear automatically the first time the unit is turned from the factory, after 10 minutes of unsuccessful satellite acquisition, or if you push the ENTER key while viewing the Satellite Page with the unit in searching, AutoLocate, acquiring, simulator, or poor coverage modes. (See pages 6-7 for more on EZinit.)

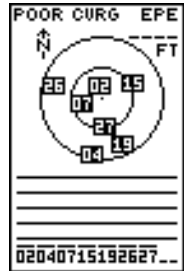

A 'POOR CVRG' status will appear on the Satellite Page if the receiver has lost the satellites required to compute a fix. Make sure the external antenna is not covered and is connected to the GPS 120XL.



If you travel more than 500 miles with the receiver off, reinitialize the unit to your new position by using the EZinit feature. To access EZinit, press ENTER from the Satellite Page before any satellites are acquired.

Backlighting & Position Page

N 015 030 NE	
TRACK	SPEED
019°	0.0%
TRIP	ALT
0.0%	976'
POSITION	
N 37°31.470'	
W048°20.080'	
TIME	
12:05:31pm	

The speed and track displayed on the Position Page may fluctuate at slow speeds (or when you're standing still) because of position errors caused by Selective Availability.

N 015 030 NE	
TRACK	SPEED
019°	0.0%
TRIP	ALT
0.0%	976'
POSITION	
N 37°31.470'	
W048°20.080'	
TIME	
12:05:33pm	

To reset the trip odometer, highlight the trip field and press ENTER. Use the LEFT arrow key to clear the distance field, and press ENTER to confirm.

Screen Backlighting

The GPS 120XL features three levels of backlighting. Activate the backlight by pressing the POWER key briefly. Each press of the button advances the backlighting to the next level and then turns it off. Backlighting will remain on until turned off. Note: a bulb icon will appear on the Satellite Page when backlighting is on.





Position Page

The GPS 120XL's Position Page shows you where you are, the direction you are heading, and your speed, and is most useful when you are traveling without an active destination waypoint. A compass tape at the top of the page displays your cardinal heading (while moving), with current track and speed over the ground indicated below. The rest of the page shows your present position in three dimensions (latitude, longitude and altitude). The units of measure for speed, distance, position and altitude are all user-selectable through the navigation setup menu (see pages 48-50). The 12/24 hour clock and time offset options are available from the system setup menu (see page 47).

Trip Odometer



The Position Page also features a resettable trip odometer to measure your total distance traveled.

To reset the trip odometer:

1. Press the  key until the trip field is highlighted.
2. Press , followed by .
3. Press  to finish.

Altitude Display

When the GPS 120XL is acquiring satellites or navigating in the 2D mode, the last known altitude will be used to compute your position. If the altitude shown is off by several hundred feet, you can manually enter your altitude for greater accuracy. Note that GPS altitudes can fluctuate due to errors.

1. Press the  key until the altitude field is highlighted and press .
2. Use the arrow keypad to enter the altitude and press .

Marking and Saving Waypoints

Knowing your present position is only part of any navigation equation. You also need to keep track of where you've been and where you are going. Waypoints serve as electronic markers that let you keep track of starting points, destinations, nav aids and any other important position.

The GPS 120XL allows you to mark, store and use up to 250 waypoints. A waypoint position can be entered by taking an instant electronic fix or by manually entering a coordinate or range and bearing in reference to an existing waypoint. If you try to mark a waypoint without having a position fix, you'll be notified with a 'No GPS Position' message.

To mark your present position:

1. Press the **MARK** key to capture your position.

The mark position page will appear, showing the captured position and a default 3-digit waypoint name.

To change the default position name:

1. Press the **▲** key twice to move the field highlight from the 'save' field to the name field.
2. Press **ENTER** to begin entry of the name. Pressing the **◀** key will clear any existing data.
3. Use the arrow keypad to enter the name.
4. Press **ENTER** to confirm the waypoint name. The field highlight will move to the 'route' field.

If you'd like to add this waypoint to a route:

1. Press the **ENTER** key.
2. Use the **▲** or **▼** keys to enter a route number and press **ENTER**.
3. Press the **ENTER** key again to save the waypoint.

If you do not want to add this waypoint to a route:

1. Highlight the 'save' field and press the **ENTER** key.

Marking & Saving Waypoints

GPS POSITION
Waypoint:
001
N 37°31.470'
W048°20.080'

Add to route
number: __
SAVE?

The GPS 120XL will automatically name new waypoints with a default three-digit name. You may then highlight the name field, press **ENTER**, and enter your own waypoint name.

GPS POSITION
Waypoint:
FISH-5
N 37°31.470'
W048°20.080'

Add to route
number: __
SAVE?

To add a waypoint to a route as you are marking its position, enter the desired route number, highlight 'SAVE?' and press **ENTER**.

Nearest Waypoints Page

MENU
NEAREST WPTS
WAYPOINT LIST
WAYPOINT
ROUTES
DIST AND SUM
TRACK LOG
INTERFACE
SYSTEM SETUP
NAV SETUP
MAP SETUP
ALARMS SETUP

To select a waypoint sub-menu, highlight the desired option and press ENTER.

NEAREST WPTS		
WAYPNT	BRG	DST
002	063'	0.04
FISH-3	107'	1.63
001	031'	1.67
DOCK	063'	2.30
FUEL	054'	3.30
COVE	120'	3.95
----	----	----
----	----	----
----	----	----

The compass heading (BRG) and distance (DST) to the nine nearest waypoints are updated continuously.

Waypoint Submenus

The GPS 120XL has three waypoint submenu pages that let you manage a large number of waypoints quickly and efficiently. The nearest waypoints, waypoint list and waypoint definition pages are accessed through the Menu Page.

To select a waypoint submenu page:

1. Press **PAGE** or **QUIT** until the Menu Page appears.
2. Use the **▲** and **▼** keys to highlight the waypoint submenu page you want to use.
3. Press **ENTER** to display the submenu page.
4. To return to the Menu Page, press the **PAGE** key.

Nearest Waypoints Page

The nearest waypoints page shows the nine nearest waypoints that are within 100 miles of your present position, with the bearing and range noted for each waypoint. During an emergency, the nearest waypoints page can give you the closest points of safety in your area at a glance.

The nearest waypoints page will also let you retrieve a waypoint definition page or GOTO a selected waypoint right from the list.

To review the waypoint definition page of a highlighted waypoint from the list:

1. Press the **ENTER** key.

To return to the nearest waypoint page (when the 'done' field is highlighted):

1. Press the **ENTER** key.

To go to a highlighted list waypoint:

1. Use the **▲** and **▼** keys to highlight a listed waypoint.
2. To select a highlighted nearest waypoint as a destination, press the **GOTO** key.
3. Once the GOTO waypoint page appears, press the **ENTER** key to confirm the selected waypoint as your destination.

Waypoint List Page

Waypoint List Page

The waypoint list page provides you with a complete list of all waypoints currently stored in the GPS 120XL. The total number of used and empty waypoints is indicated above the waypoint list. From the waypoint list page, you can retrieve a waypoint definition page, delete all user-defined waypoints, or GOTO a selected waypoint. If a waypoint is currently used in a route, the lowest route number will be indicated to the left of the waypoint name.

To review the waypoint definition page of a highlighted list waypoint:

1. Press the **ENTER** key.

To return to the waypoint list page (with the 'done' field highlighted):

1. Press the **ENTER** key.

To GOTO a list waypoint:

1. Use the **▲** and **▼** keys to scroll through the list and select a waypoint.
2. To select a highlighted waypoint as a destination, press the **GOTO** key.
3. Once the GOTO waypoint page appears, press the **ENTER** key to confirm the selected waypoint as your destination.

To delete all user-defined waypoints:

1. Use the **▲** or **▼** keys to move the cursor highlight to the 'delete all waypoints' field.
2. Press the **ENTER** key.

A warning page will appear, asking if you are sure you want to delete all user-defined waypoints and routes. If you want to continue and delete:

1. Press the **◀** key to highlight the 'Yes' field.
2. Press the **ENTER** key.
3. Press the **QUIT** key to return to the Menu Page.

If you do not want to delete all waypoints:

1. Press **ENTER** with the 'no' field highlighted.

WAYPOINT LIST	
243 EMPTY	7 USED
	001
	002
R03	COVE
R03	DOCK
R03	FISH-3
	FISH-7
R03	FUEL

DEL ALL WPTS?	

The total number of used and available waypoints is indicated at the top of the page. Route waypoints are indicated by an 'R_'. Above, R03 means route 3.

DEL ALL WPTS
WARNING!
all user defined waypoints and routes will be deleted
Are you sure Yes? or No?

Deleting all user waypoints will also delete all routes stored in memory.

Waypoint Definition Page

WAYPOINT	
NAME: DAM	
N 37°30.650'	
W048°22.093'	

REF: -----	
BRG	DST
000°	0.00%
RENAME? NEW?	
DELETE? DONE?	

Use the waypoint definition page to review, rename, or delete stored waypoints and to create new waypoints manually.

WAYPOINT	
NAME: █	

REF: -----	
BRG	DST
---	---
RENAME? NEW?	
DELETE? DONE?	

To create a new waypoint by manually entering coordinates or by referencing an existing waypoint, highlight the 'NEW?' prompt and press the ENTER key.

Waypoint Definition Page

The last of the three waypoint management pages is the waypoint definition page. This page lets you create new waypoints manually, or review and edit existing waypoints.

WAYPOINT		
Waypoint Name	NAME: FISH-6	Position Coordinates
	N 39°00.000'	
	W095°02.992'	Waypoint Comment
	BARBERS POINT	
Reference Waypoint	REF: DOCK	Distance from Reference Waypoint
	BRG DST	
Bearing from Reference Waypoint	266° 2.33%	
	RENAME? NEW?	
	DELETE? DONE?	Function Prompts

To create a new waypoint manually, you'll need to know its position coordinates or its distance and bearing from an existing waypoint.

To create a waypoint by entering coordinates:

1. If a waypoint is currently displayed in the name field, highlight 'NEW?' and press **ENTER**. Then press the **◀** key to clear the name field.
2. Use **▲** and **▼** to enter your waypoint name and use **◀** and **▶** to move to the next character position.
3. Press **ENTER** to confirm the waypoint name. The position field will now become highlighted, with the receiver's last known position shown, if one exists.
4. Press **ENTER** to begin entry of the position.
5. Use the **▲** and **▼** keys to enter your position, and use the **◀** and **▶** keys to move to each character field.
6. Press **ENTER** to confirm and save your coordinates. The default waypoint comment (UTC date and time of creation) will appear, and the highlight will move to 'DONE?'.

7. Press the **ENTER** key to return to the Menu Page.

Reference Waypoints

To create a new waypoint manually without knowing its position coordinates, you'll need to enter its bearing and distance from an existing waypoint. The GPS 120XL will then calculate the position coordinates for you.

WAYPOINT	
NAME:	DAM
N	37°30.650'
W	048°22.093'

REF:	<input checked="" type="checkbox"/> COVE
BRG	DST
000°	0.00%
RENAME?	NEW?
DELETE?	DONE?

To create a new waypoint by referencing a stored waypoint:

1. Press **▲** until the 'NEW?' field is highlighted.
2. Press **ENTER**.
3. Enter the name of your new waypoint.
4. Press the **ENTER** key to confirm the waypoint name.
The position field will now become highlighted, with the receiver's last known position shown.
5. Press **▼** to move the cursor to the reference field.
6. Press **ENTER** to begin entry of the reference waypoint or leave this field blank to use your present position.
7. Use the arrow keypad to enter the waypoint name.
8. Press the **ENTER** key to confirm your entry.
9. Enter the bearing and distance of your new waypoint from the reference waypoint. Remember to use the **ENTER** key to begin entry and confirm each field. The coordinates will be calculated and saved for your new waypoint.
10. Press the **ENTER** key (with the 'done' field highlighted) to return to the Menu Page.

REFERENCE

Reference Waypoints

WAYPOINT	
NAME:	COVE
N	37°29.939'
W	048°17.204'

REF:	-----
BRG	DST
120°	<input checked="" type="checkbox"/> 0.00%
RENAME?	NEW?
DELETE?	DONE?

The GPS 120XL's advanced waypoint and planning features allow you to create new waypoints and practice navigation without ever leaving the slip.

If you create a new waypoint by entering coordinates from a map, you may want to re-mark the waypoint's exact position once you get there. To re-define an existing waypoint's position coordinates from the waypoint definition page, simply highlight the 'DST' field and press ENTER. Use the LEFT arrow key to set the distance to 0.00, and press ENTER to confirm.

The old coordinates will be replaced by the coordinates of your present position (you must have a valid 2D or 3D position fix).

Editing, Deleting & Renaming Waypoints

WAYPOINT	
NAME: COVE	
N 37°29.939'	
W048°17.204'	
---SHALLOW AREA---	
REF: -----	
BRG	DST
120°	3.95%
RENAME?	NEW?
DELETE?	DONE?

The waypoint comment field will automatically display the date and time of creation of the waypoint. You may replace this with a 16-character custom comment at any time.

WAYPOINT	
NAME: COVE	
N 37°29.939'	
W048°17.204'	
SHALLOW AREA	
REF: -----	
BRG	DST
120°	3.95%
RENAME?	NEW?
DELETE?	DONE?

To access the rename function from the waypoint definition page, highlight the 'RENAME?' prompt and press ENTER.

Editing Existing Waypoints

The waypoint definition page also allows you to change the name, coordinates, comment or reference waypoint field for a stored waypoint (Fields shown on page 22).

To edit the name, coordinates, comment, or reference waypoint field:

1. Use ▲ and ▼ to highlight the field you want to edit.
2. Press **ENTER** to begin entry in the selected field.
3. Enter your new data.
4. Press the **ENTER** key to confirm your changes.

Waypoint Comments

Each waypoint stored in the GPS 120XL has a user-defined 16-character comment field. The default comment is the UTC date and time of the waypoint's creation.

To change or add a comment:

1. Use the ▲ and ▼ keys to highlight the comment field.
2. Press **ENTER** to begin entry of your comment.
3. Enter the comment and press the **ENTER** key to confirm.

Renaming and Deleting Waypoints

RENAME WAYPNT
From
001
To:
COVE---
Are you sure Yes? or No?

The rename and delete function fields are located at the bottom left of the waypoint definition page (you'll need to use the ◀ key to move the field highlight out of its standard up-and-down scrolling sequence).

Editing and Scanning Waypoints

To rename a stored waypoint:

1. Highlight the 'RENAME?' field and press **ENTER**.
2. Enter the new waypoint name and press **ENTER**.
3. Press the **ENTER** key to confirm your changes.

To delete a stored waypoint:

WAYPOINT	
NAME: FISH-3	
N 37°30.715'	
W048°20.048'	
23-FEB-97 00:18	
REF: -----	
BRG	DST
107°	1.63%
RENAME?	NEW?
DELETE?	DONE?

1. Highlight the 'DELETE?' field and press **ENTER**.
2. Press the **◀** key to select the 'YES' prompt.
3. Press **ENTER** to delete the waypoint.

Scanning Waypoints

As you manually enter a waypoint's name, the GPS 120XL's waypoint scanning feature will automatically display the first numerical or alphabetical match of the character you have entered to that point. This helps eliminate the need to always enter a waypoint's complete name.

To scan waypoints from a waypoint field:

1. Highlight the waypoint name field and press **ENTER**.
2. Press the **◀** key to clear the name field.
3. Use the **▲** and **▼** keys to scroll through waypoints.
4. If you have more than one waypoint that begins with the same letter or number, you must use the **▶** key to move to the next character positions as needed. Only the first character match is listed for each name.
5. Once you've found the desired waypoint, press **ENTER**.

DELETE WAYPNT	
WARNING!	
FISH-7	
will be deleted	
Are you sure	
Yes? or No?	

A warning page will ask you for confirmation to delete the selected waypoint.

Note: If a waypoint is part of a route, it must be removed before it can be deleted. (See p 34)

WAYPOINT	
NAME:	FISH-3
N 37°32.032'	
W048°23.909'	
23-FEB-97 00:33	
REF: -----	
BRG	DST
333°	2.00%
RENAME?	NEW?
DELETE?	DONE?

Waypoint names will appear alphabetically when scanning waypoints. If two waypoints begin with the same letter(s) you must move the cursor to the first letter they do not have in common for them to appear.

Starting/Stopping a GOTO & MOB

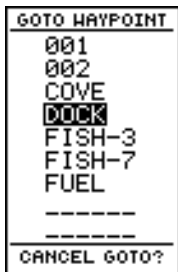

Select a destination waypoint from the GOTO waypoint list.

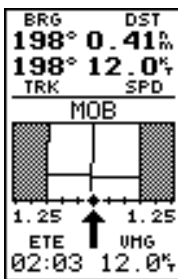

Once the MOB mode has been activated, steering guidance will be provided by the highway or compass page. Activating another MOB will replace the previous MOB waypoint.

Selecting a GOTO Destination

The GPS 120XL provides four ways to navigate to a destination: GOTO, MOB, TracBack and route navigation. The most basic method of selecting a destination is the GOTO function, which lets you choose any stored waypoint as the destination and quickly sets a direct course from your present position.

To activate the GOTO function:

1. Press the **GOTO** key. The GOTO waypoint list, an alphabetical list of all available waypoints, will appear.
2. Use the **▲** and **▼** keys to select the waypoint you want to navigate to (it may already be highlighted).
3. Press the **ENTER** key to confirm, or **QUIT** to stop selection of a GOTO destination and return to the previous page.

Once a GOTO waypoint has been activated, the Compass Page or Highway Page will provide steering guidance to the destination until either the GOTO is cancelled or the unit has resumed navigating the active route (see page 34).

To cancel an active GOTO:

1. Press the **GOTO** key.
2. Use the arrow keypad to move the field highlight to the 'CANCEL GOTO?' prompt at the bottom of the page and press **ENTER**.

Man Overboard Function

The GPS 120XL's man overboard function (MOB) lets you simultaneously mark and set a course to a position for quick response to passing positions (like the spot where your hat blew overboard).

To activate the MOB mode:

1. Press the **MOB** key. The GOTO waypoint page will appear with 'MOB' selected as the default destination.
2. Press the **ENTER** key to begin MOB navigation.

The GPS 120XL will now guide you to the MOB waypoint until the MOB GOTO is cancelled (see "to cancel an active GOTO" above). If you want to save the MOB waypoint, be sure to rename it, because it will be overwritten the next time a MOB is executed.

TracBack Navigation

TracBack Navigation

The third method of navigating to a destination is by using the GARMIN'S patented TracBack feature. The TracBack function allows you to quickly and easily retrace your path using the track log automatically stored in the receiver's memory. The advantage of the TracBack feature is to eliminate the need to mark waypoints along the way and manually create and activate a route back to where you began your trip.

The TracBack route is created by reducing your current track log into a route of up to 30 waypoints, and activating an inverted route along those points. Once activated, a TracBack route will lead you back to the oldest track log point stored in memory, so it's usually a good idea to clear the existing track log at the starting point of your current trip (e.g. your car or the dock) *before* you get started.

To clear the track log and define a starting point for a TracBack route:

1. From the Menu Page, highlight 'TRACK LOG'.
2. Press **ENTER** to access the track log page.
3. Use the **▲** key to highlight the 'CLEAR LOG?' option.
4. Press **ENTER**. A confirmation page will appear.
5. Use **◀** to highlight the 'Yes?' prompt and press **ENTER**.

To activate a TracBack route:

1. From the Menu Page, highlight 'TRACK LOG' option.
2. Press **ENTER** to access the track log page.
3. Highlight the 'TRACBACK?' option and press **ENTER**.

Once the TracBack function has been activated, the GPS 120XL will take the track log currently stored in memory and divide it into segments called legs. Up to 30 temporary waypoints (e.g., 'T001') will be created to mark the most significant features of the track log in order to duplicate your exact path as closely as possible. A TracBack route from your present position to the oldest track log point will be created as the active route (the active route page will appear), and provide steering guidance to each waypoint back to the starting point of your track log.

TRACK LOG
RECORD: Yes
CRITERIA: Automatic
MEMORY USED 16 of 768 points (2%)
CLEAR LOG? TRACBACK?

Clearing the log before you get started will define the position the TracBack function will return you to.

TRACK LOG
RECORD: Yes
CRITERIA: Automatic
MEMORY USED 16 of 768 points (2%)
CLEAR LOG? TRACBACK?

Highlight 'TRACBACK?' and press ENTER to begin TracBack navigation.

TracBack Navigation

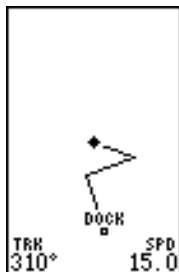

The TracBack feature will navigate your track log back to the oldest point in the receiver's memory.

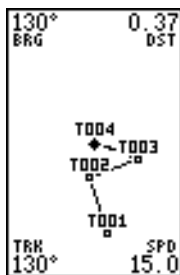

The track log will be divided into segments with temporary waypoints to create a route back to the beginning of the track log.

Tips on Creating and Using the TracBack Feature

The GPS 120XL's TracBack feature is designed to help you quickly create and activate a route that follows your path back to a user-defined starting point. To get the most out of the TracBack feature, remember the following tips:

- Always clear your track log at the exact point that you want to go back to (truck, dock, etc.).
- The 'RECORD' option on the track log setup page must be set to the 'Yes' position.
- There must be at least two track log points stored in memory to create a TracBack route.
- If there are not enough available waypoints in memory to create a TracBack route, you will be alerted with a 'waypoint memory full' message, and the receiver will use any available waypoints to create a TracBack route with an emphasis on the track log closest to the destination (the oldest track log point in memory).
- If the 'CRITERIA' option on the track log setup page is set to a time interval, the TracBack route may not follow your exact path (the automatic setting will provide the best TracBack route).
- If the receiver is turned off or you lose satellite coverage during your trip, the TracBack route will simply draw a straight line between any point where coverage was lost and where it resumed.
- If the changes of direction and distance of your track log are very complex, 30 waypoints may not be enough to accurately mark your exact path. The receiver will then assign the 30 waypoints to the most significant points of your track.
- If you want to save a TracBack route, copy route 0 to an open storage route before activating another TracBack. Activating another TracBack or storage route will overwrite the existing TracBack route.
- Whenever a TracBack route is activated, temporary waypoints (e.g., 'T001') that are not contained in routes 1-19 are erased. If there are temporary waypoints stored in routes 1-19, the receiver will create any new temporary waypoints using the first three-digit number available.

Creating and Navigating Routes

The last form of navigating to a destination with the GPS 120XL is by creating a user-defined route. The route navigation feature lets you plan and navigate a course from one place to another using a set of pre-defined waypoints. Routes are often used when it's not practical, safe or possible to navigate a direct course to a particular destination (e.g., through a body of water or impassable terrain).

Routes are broken down and navigated in smaller segments called "legs". The waypoint you are going to in a leg is called the "active to" waypoint, and the waypoint immediately behind you is called the "active from" waypoint. The line between the "active to" and the "active from" waypoint is called the "active leg".

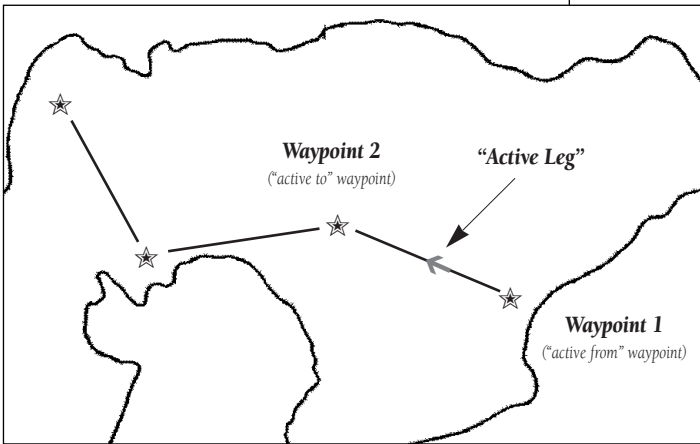

Whenever you activate a route with the GPS 120XL, it will automatically select the route leg closest to your position as the active leg. As you pass each waypoint in the route, the receiver will automatically sequence and select the next waypoint as the "active to" waypoint.

Defining a Route

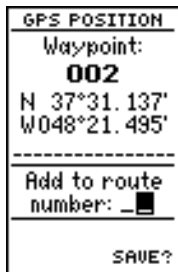

If you're heading out without a planned route, the mark function can be used to quickly create a route back to your starting point.

Create a series of waypoints along the way with the MARK key and save them to an open route from the mark position page. When you're ready to head back, simply activate the route you created in inverted order (see page 32).

Route Definition Page

The GPS 120XL lets you create and store up to 20 routes of 30 waypoints each. Routes are created, copied and edited through the route definition page, which is accessed through the Menu Page.

To select the route definition page:

1. Press **PAGE** until the Menu Page appears.
2. Use the **▲** and **▼** keys to highlight the 'ROUTES' option.
3. Press the **ENTER** key to display the route definition page.
4. To return to the Menu Page, press **PAGE**.

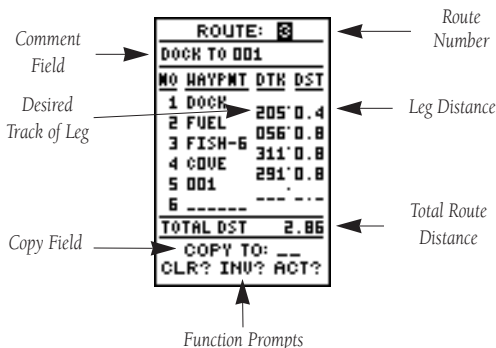

The route number field is displayed at the top of the page, with a 16-character user comment below. If no user comment is entered, the field will display the first and last waypoint in the route. The waypoint list in the middle of the page accepts up to 30 waypoints for each route, with fields for desired track and distance between legs. The total distance of the route is indicated below the waypoint list.

The bottom of the route definition page features several function fields which let you copy, clear, invert or activate the displayed route. Routes 1-19 are used as storage routes, with route 0 always serving as the active route you are navigating. If you want to save a route currently in route 0, be sure to copy it to another open route, as it will be overwritten by the next route activation.

Creating, Copying & Clearing Routes

To create a route from the route definition page:

1. Highlight the route number field and press **ENTER**.
2. Enter a route number and press the **ENTER** key to confirm.
3. Press **ENTER** to begin entry of a route comment. (Note that the default [first and last waypoint] comment will only appear if the comment field is blank.)
4. Enter your comment and press the **ENTER** key.
5. Highlight the No. 1 waypoint field and press **ENTER**.
6. Enter the first waypoint of your route and press **ENTER**.
7. Continue entering the rest of your waypoints in order, using the **ENTER** key to start and confirm each field entry. The list will automatically scroll down.
8. After you have entered all your waypoints, press **PAGE**.

Copying and Clearing Routes

The route definition page is also used to copy a route to another route number. This feature is useful when you make changes to the active (or TracBack) route and want to save the route for future use.

To copy a route:

1. Highlight the route number field and press **ENTER**.
2. Enter the route number to be copied and press **ENTER**.
3. Highlight the 'COPY TO' field and press **ENTER**.
4. Scroll through the available routes and select a destination route number. Only open routes will be available as choices. Press the **ENTER** key to copy the route.
5. Press the **PAGE** key to return to the Menu Page.

To clear a route from memory:

1. Highlight the route number field and press **ENTER**.
2. Enter the route number and press **ENTER**.
3. Select the 'CLR?' prompt and press **ENTER**.

ROUTE: 4			
NO	WAYPNT	DTH	DST
1	DOVE	---	---
2	---	---	---
3	---	---	---
4	---	---	---
5	---	---	---
6	---	---	---
TOTAL DST			0.00
COPY TO: --			
CLR? INV? ACT?			

Enter each waypoint in the order you would like to navigate them. If you enter a waypoint not stored in memory, you'll need to define the position on the waypoint definition page.

ROUTE: 3			
DOCK TO 001			
NO	WAYPNT	DTH	DST
1	DOCK	205'	0.4
2	FUEL	056'	0.8
3	FISH-6	311'	0.8
4	DOVE	291'	0.8
5	001	---	---
6	---	---	---
TOTAL DST			2.86
COPY TO: 10?			
CLR? INV? ACT?			

To copy a route, select an open storage route and press the **ENTER** key. If you select a route that is already used, you'll be alerted with a 'Roue Full' Message.

Clearing, Activating and Inverting Routes

CLEAR ROUTE
WARNING!
all waypoints will be removed from this route
Are you sure Yes? or No?

Clearing a route only removes the waypoints from the route selected. The waypoints used for the route will still remain in memory individually.

ROUTE: 3			
DOCK TO 001			
NO	WAYPNT	DTH	DST
1	DOCK	205'	0.4
2	FUEL	056'	0.8
3	FISH-6	311'	0.8
4	COVE	291'	0.8
5	001		
6	-----		
TOTAL DST			2.86
COPY TO: --			
CLR? INV? ACT?			

To activate a route, highlight the 'ACT?' prompt and press ENTER.

Clearing Routes (continued)

The clear route warning will appear, asking you to confirm that you want to remove all waypoints from the route.

1. Highlight the 'Yes?' field with the ◀ key.
2. Press **ENTER** to confirm your action.
3. Press **PAGE** to return to the Menu Page.

Activating and Inverting Routes

After a route has been entered, it can be activated in its defined sequence or inverted from the route definition page. The process of activating or inverting a stored route takes a storage route (routes 1-19) and copies it into the active route (route 0) for navigation.

This system allows you to have an active route that you may edit during navigation and save as an entirely new route from the original. You will have to copy the active route to an unused storage route to save it, since new route or TracBack activation overwrites route 0.

To activate a route:

1. Select the route definition page and press the **ENTER** key to activate the route number field.
2. Enter the route number to be activated and press **ENTER**.
3. Move the field highlight to the 'ACT?' prompt and press the **ENTER** key.

Inverting a route allows you to navigate route legs in reverse order without editing the original route.

To activate a route in inverted order:

1. Follow the steps above, but select the 'INV?' prompt and press **ENTER**.

Active Route Page

Active Route Page

Once a route has been activated, the active route page will appear, displaying the waypoint sequence of your route with the estimated time enroute (ETE) at your present speed and distance to each waypoint. As long as you are navigating an active route, the active route page will become part of the primary page sequence of the unit.

The active route page will also allow you to change the ETE field to display desired track (DTK) or estimated time of arrival (ETA) for each leg. In addition you can also clear or invert the active route.

To display DTK or ETA for each leg:

1. Highlight the estimated time enroute (ETE) field and press the **ENTER** key.
2. Use the **▲** or **▼** keys to select 'DTK' or 'ETA' and press the **ENTER** key.

The active route page also allows you to clear (stop navigating) or invert the active route without using the route definition page.

To invert a route from the active route page:

1. Press the **▲** key once to move the field highlight to the 'INVERT?' prompt.
2. Press the **ENTER** key to invert the route.

To clear the active route from the active route page and stop route navigation:

1. Use the **▲** and **◀** keys to select the 'CLEAR?' prompt.
2. Press the **ENTER** key to clear the active route.

Editing Routes

Once a route has been created and stored, it can be edited at any time, even if it is the active route.

To edit a route from the active route page or the route definition page:

1. Use the **▲** and **▼** keys to select the waypoint you want to edit and press **ENTER**.

ACTIVE ROUTE		
DOCK TO 001		
WAYPNT	ETE	DST
DOCK	--:--	----
FUEL	04:45	0.40
FISH-6	14:21	1.20
GOVE	24:10	2.01
001	34:14	2.85
-----	----	----
-----	----	----
-----	----	----
CLEAR? INVERT?		

Whenever you have activated a route, the active route page will appear in the primary page sequence after the highway/compass page.

ACTIVE ROUTE		
DOCK TO 001		
WAYPNT	ETE	DST
DOCK	--:--	----
FUEL	04:41	0.39
FISH-6	14:17	1.19
GOVE	24:06	2.01
001	34:10	2.85
-----	----	----
-----	----	----
-----	----	----
CLEAR? INVERT?		

To edit or review a route waypoints from the active route page, highlight the desired waypoint and press **ENTER**.

Editing Routes & On-Route GOTO's



Use the on-screen menu to select the desired editing function.

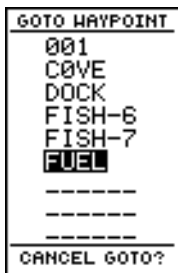

You can skip ahead and navigate to any route waypoint by highlighting the desired waypoint and pressing the GOTO key.

Editing Routes (continued)

An on-screen menu of editing choices will appear, with options for reviewing, inserting, deleting or changing the waypoint field highlighted. Use the ▲ and ▼ arrow keys to select among the editing choices.

Once you've selected a waypoint from the route list, choose a menu function:

1. To review the definition page for the waypoint, highlight the 'REVIEW?' prompt and press **ENTER**.
2. To add a new waypoint preceding the selected waypoint, highlight the 'INSERT?' prompt and press **ENTER**.
3. To remove the selected waypoint, highlight the 'REMOVE?' prompt and press the **ENTER** key.
4. To replace the selected waypoint with a new waypoint, highlight the 'CHANGE?' prompt and press **ENTER**.

Use the route waypoint editing instructions described earlier for creating a route to complete your changes. If you are editing the active route (route 0), copy your new route version to an empty route to save it, because the active route will be overwritten by a new route activation.

If you add, delete or change the first or last waypoint of a route, the default comment (first and last waypoint) will automatically be updated.

On-Route GOTOs

At the beginning of this section, we mentioned that the GPS 120XL will automatically select the route leg closest to your position as the active leg. This will give you steering guidance to the desired track of the active leg. If you would prefer to steer directly to a route waypoint, you can perform an "on-route GOTO" from the active route page.

1. Use the ▲ and ▼ keys to highlight the desired route waypoint and press the **GOTO** key.
2. Once the GOTO waypoint page appears, press **ENTER** to confirm the on-route GOTO waypoint.

Note that after you reach the on-route GOTO waypoint, the GPS 120XL will automatically resume navigating the rest of the route in sequence.

Highway & Compass Pages

User-Defined Navigation Pages

Once you've selected a GOTO destination or activated a MOB or route, the GPS 120XL will provide graphic steering guidance to the destination with one of two navigation pages:

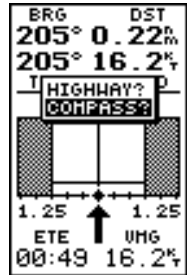
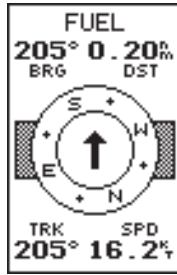
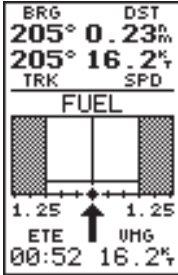

To switch the navigation page to the Compass Page, press **ENTER** twice.

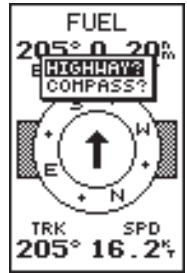

To switch the navigation page to the Highway Page, press **ENTER** twice.

- The Highway Page (the default navigation page) provides a graphic highway that shows your movement relative to the desired course, with an emphasis on your crosstrack error (the distance and direction you are off course). The Highway Page is well suited for boating and other activities with higher speeds and straight line courses to a destination.
- The Compass Page provides a directional pointer to the destination, with a rotating compass graphic to display your direction of travel. The Compass Page is ideal for activities like trawling or entering a harbor, and provides better steering guidance for slow-speed (e.g., walking) travel with many directional changes.

Both pages provide a digital display of the bearing and distance to the destination, your current speed and track over the ground, and course deviation indicator (CDI). Select the desired navigation page at any time.

To select the Compass or Highway Page:

1. Press **PAGE** until the current navigation page appears.
2. Press **ENTER**. An on-screen box will appear, with the navigation page not currently in use highlighted as the default.
3. Press **ENTER** to switch the navigation screen.

Highway Page

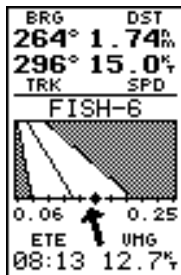

In this example, the Highway Page indicates that you are off course to the right. Steer left to get back on course. Notice the emphasis of the Highway Page is on the desired course.



If you get too far off course, a message box will appear to indicate what course to steer to get back on course most efficiently.

Using the Highway Page

The GPS 120XL's Highway Page also provides graphic steering guidance to a destination, with a greater emphasis on the straight-line desired course and the distance and direction you are off course. The bearing and distance to a waypoint, along with your current track and speed are displayed at the top of the screen, with your estimated time enroute (ETE) and velocity made good (VMG, or the rate you are closing in on your destination) at the bottom.

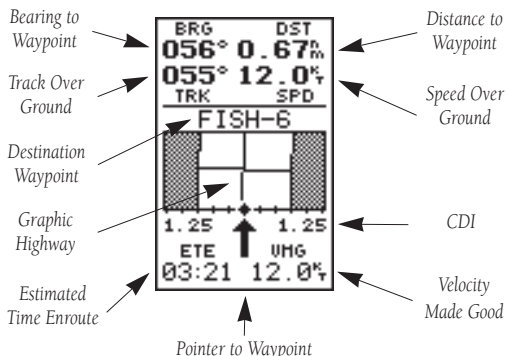

As you head toward your destination, the middle section of the screen provides visual guidance to your waypoint on a moving graphic "highway". The moving arrow just below the course deviation scale always points to your selected waypoint relative to the direction you are moving.

Your present position is represented by the diamond in the center of the course deviation scale. The line down the middle of the highway represents your desired track. As you navigate toward a waypoint, the highway will actually move, indicating the direction you're off course, relative to the position diamond on the CDI scale. To stay on course, simply steer toward the center of the highway.

If you do get off the desired course by more than 1/5th of the selected CDI range, the exact distance you are off course will be displayed where the CDI scale setting normally appears (see the example at left). If you get too far off course (the highway has disappeared), a message box will appear to indicate what course to steer to get back on course.

Compass Page

Using the Compass Page

The GPS 120XL's Compass Page provides graphic steering guidance to a destination waypoint. The bearing (BRG) and distance (DST) to the waypoint are displayed at the top of the page, right below the destination waypoint field. The distance displayed is always the straight-line distance from your present position to the destination waypoint. The bearing indicates the exact compass heading from you to the destination.

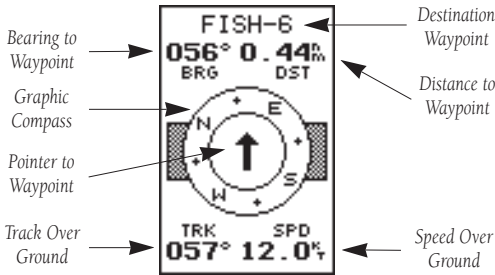

The middle of the page features a rotating “compass” that shows your current cardinal heading while you’re moving (track up), with a pointer arrow in the center to indicate the direction of the destination relative to the direction you are moving. The compass rose and pointer arrow combine to show current direction and current destination at a glance.

The bottom of the Compass Page shows your current track (TRK) and speed (SPD) over the ground.

When you are one minute away from the destination (based on your current speed and track over the ground), the GPS 120XL will alert you with a flashing on-screen message box.

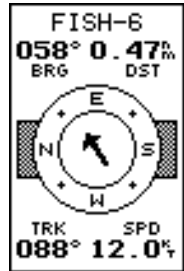

In this example, the Compass Page indicates that you are traveling in an easterly (088 degrees) direction and the destination waypoint is northeast (058 degrees) of your current direction of travel.

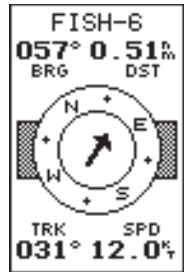

In this example, the Compass Page indicates that you are traveling in a northerly (031 degrees) and the destination waypoint is east (057 degrees) of your current direction of travel.

Map Page

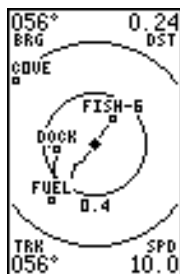

The GPS 120XL has on-screen range rings to help you estimate distances relative to your present position. The value of each ring is determined by the current zoom scale, and is equal to 1/5 of the selected scale.

To turn the range rings display on or off (the default setting is OFF) see the map setup instructions on pages 51-52.

Map Page

The GPS 120XL features a powerful real-time moving map that can do much more than just plot your course and route. The Map Page also provides you with a target cursor that will let you pan ahead to nearby waypoints, determine the distance and bearing to any map position, and mark new waypoints while you navigate.

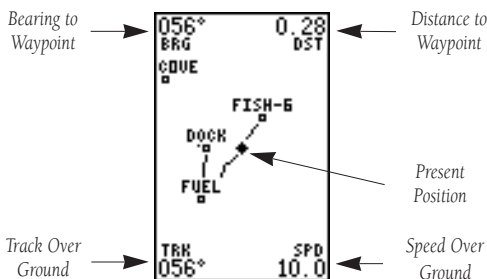

The map contains 12 selectable range scales from 0.2 to 320 miles (0.5 to 600 km). The scale represents the distance shown from the top of the screen to the bottom. Move from scale to scale by using the dedicated zoom keys (IN and OUT). Pressing IN decreases the scale and pressing OUT increases the scale.

A diamond icon in the center of the page represents your present position, with your track and/or route displayed as a solid line. Nearby waypoints are shown as squares, with the corresponding name listed. You may select which items are shown through the map setup submenu page (see pages 51-52 for more information).

The four corners of the Map Page are used to display various navigation data, including the bearing and distance to a destination waypoint and your current track and speed over the ground. The two fields at the top corners of the map show your bearing and distance to one of three selectable destinations: an active destination waypoint; a highlighted on-screen waypoint; or the panning target crosshair. If you are not navigating to a waypoint or using the panning function, the top data fields will not be displayed. The bottom corners of the display always show your current track and speed.

Map Zooming, Panning, & Pointing

Zooming, Panning, and Pointing

There are three main functions you can perform from the Map Page: zooming, panning, and pointing. Zooming is increasing or decreasing the display scale of the map. Panning is using a target crosshair and the arrow keypad to “slide” the map window in any direction, including diagonally, to view the surrounding area. Pointing is the act of highlighting a waypoint on the map in order to find out more about the waypoint and conduct a GOTO, or highlighting a position on the map to create a new waypoint and conduct a GOTO.

To select a zoom scale (even while panning):

1. Press **IN** or **OUT** once for each level of increase or decrease desired.
2. Press and hold down either key to increase or decrease by more than one scale.

To activate the pan function:

1. Press the arrow keypad in any direction, including diagonally.

As you begin to move the map, a crosshair will appear. This crosshair will now serve as a target marker for the moving map. The distance and bearing from your present position to the target crosshair will appear in the upper corners of the map. If you are conducting a GOTO at the time you activate the panning function, the crosshair bearing and distance will replace the bearing and distance of the GOTO waypoint.

As you pan around the map, you’ll notice that the target crosshair will point to on-screen waypoints and highlight the waypoint name. Once a waypoint name is highlighted, you can review its waypoint definition page or execute a GOTO function right from the Map Page.

To review the definition page for a waypoint highlighted on the map:

1. Press **ENTER**. The waypoint definition page will appear. Review and make any desired changes to the highlighted waypoint.
2. When finished, highlight the ‘DONE?’ field and press **ENTER**.

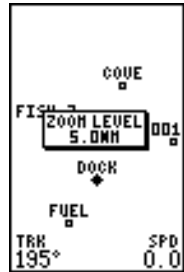

To change the map scale, press the **IN** or **OUT** key once for each level desired. An on-screen window will display the current zoom scale.

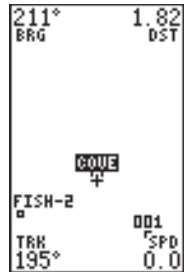

The crosshair will “snap” to waypoints highlighted on the map, which allows you to quickly review or GOTO the selected waypoint right from the Map Page.

Using the Cursor on the Map

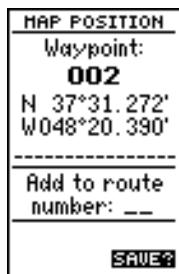

To mark a waypoint with the crosshair, simply pan to the desired position and press the ENTER key.

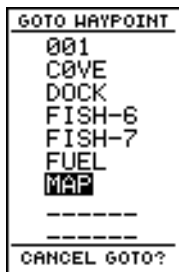

The crosshair may also be used to define a GOTO destination by panning to the desired position and pressing the GOTO key. To save the MAP waypoint, rename it, as it will be overwritten by the next MAP waypoint.

Zooming, Panning, & Pointing (continued)

To go to a waypoint highlighted on the map:

1. Press the **GOTO** key. The GOTO waypoint page will appear with the waypoint's name highlighted.
2. Press the **ENTER** key to confirm.

To stop the panning function and display your present position:

1. Press the **QUIT** key.

Using the Cursor to Mark and GOTO Waypoints

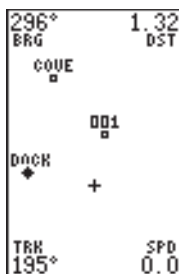

During panning, the crosshair represents a target position right on the moving map, with the range and bearing to the target displayed at the top corners of the screen.

To mark the target crosshair position as a new waypoint:

1. Press the **ENTER** key to capture the position.
2. Enter a new name and route number and press **ENTER**.

You can also use the target crosshair as an instant GOTO destination. This function will mark and instantly set a course for a new waypoint called 'MAP'.

To GOTO the target crosshair:

1. Press the **GOTO** key to capture the position.
2. Press the **ENTER** key to confirm the MAP GOTO.

To save the MAP waypoint, rename it, as it will be overwritten the next time a map GOTO is executed.

Menu Page & Distance/Sun Calculation

Menu Page

The GPS 120XL Menu Page provides access to submenu pages that are used to select and customize operation and navigation setup. The 11 submenus are divided into categories by function. See pages 19-34 for a discussion of waypoint and route management submenus. We'll now address the rest of the submenus in the order they appear on the Menu Page.

To select a submenu page from the Menu Page:

1. Highlight the submenu page you want to view.
2. Press the **ENTER** key to display the submenu page.
3. To return to the Menu Page, press the **QUIT** key.

Distance and Sun Calculation

The distance and sun calculation page will give you the distance and bearing between any two waypoints and will calculate the sunrise and sunset (in local time) at a destination waypoint for a particular date.

To perform a distance and sun calculation:

1. Highlight the 'from' field and enter the desired waypoint. Press **ENTER** to move to the next field.
2. Highlight the 'to' field and enter the destination waypoint. Press the **ENTER** key to calculate the range and bearing to the destination waypoint.
3. Highlight the 'date' field and enter the date for your destination. Press the **ENTER** key to display the sun information.

Message Page

The message page is used to display all messages in the GPS 120XL. There are two types of messages: temporary alerts (e.g. approaching a waypoint) and condition alerts (e.g., battery power is low). All messages are indicated by a flashing on-screen box. After a temporary alert has been viewed, it is cleared. Condition alerts are displayed on the message page until the condition has been resolved.

To view the message page:

1. Highlight the 'MESSAGES' field and press **ENTER**.

See Appendix C for a complete list of messages.



To select a submenu, use the UP and DOWN arrow keys to highlight a menu option and press ENTER.

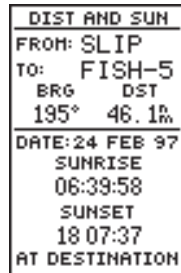

The GPS 120XL will calculate the sunrise and sunset times of any stored waypoint or your present position. To calculate, enter the date and year and press ENTER.

Track Log Setup

TRACK LOG	
RECORD:	Yes
CRITERIA:	
Automatic	
MEMORY USED	
16 of 768	
points (2%)	
CLEAR LOG?	
TRACBACK?	

Turning the track recording option off will prevent you from using the TracBack option.

TRACK LOG	
RECORD:	Yes
CRITERIA:	
Time Interval:	
00:00:30	
MEMORY USED	
19 of 768	
points (2%)	
CLEAR LOG?	
TRACBACK?	

Entering a time interval in to the track recording criteria will plot your position points further apart than they would be in the "Automatic" setting. This will increase the distance you can travel without using up your track log, but will greatly reduce the effectiveness of TracBack.

Track Log Setup Page

The track log setup page lets you manage the GPS 120XI's tracking data. From this page, you can select whether or not to record a track and define how it is recorded. Note: Track display options (showing or not showing a recorded track log on the Map Page). are addressed on page 52.

To turn track log recording on or off:

1. Highlight the 'RECORD' field and press **ENTER**.
2. Select 'Yes' or 'No' and press **ENTER**. NOTE: Turning the track recording off will disable the TracBack feature.

Track Criteria

The stored track criteria determines how often positions are stored in the track log. The default setting is automatic, which will store a track based on resolution. This setting gives you the most efficient use of track memory and provides the most accurate TracBack route.

To change the criteria to record points based upon a specific time interval:

1. Highlight the 'CRITERIA' field and press **ENTER**.
2. Use **▲** or **▼** to select 'Time Interval' and press **ENTER**.
3. Press **ENTER** to begin entry of the interval.
4. Enter a value in hours, minutes and seconds, and press the **ENTER** key.

Managing and Clearing the Track Log

The rest of the track log setup page displays the percentage of available memory currently used to store track log data and function fields in order to clear the track log memory and activate the TracBack feature.

To clear the track log:

1. Highlight 'CLEAR LOG?' and press **ENTER**.
2. A warning page will appear, and ask you to confirm your actions. Use the **◀** key to move the field highlight to the 'Yes?' field and press **ENTER**.

TracBack & Interface Options

TracBack Function

The TracBack option lets you activate a TracBack route using the track log (see pages 29-30 for more information).

To activate a TracBack route:

1. Highlight the 'TRACBACK?' option and press **ENTER**.

Interface Setup

The interface setup page lets you specify the interfacing formats for connecting external devices. There are five interface options: GRMN/GRMN, None/NONE, None/NMEA, RTCM/None, and RTCM/NMEA. Each option lists the input format first, followed by the output format.

To select I/O format:

1. Highlight the I/O field and press **ENTER**.
2. Use the **▲** and **▼** keys to toggle through and select the desired setting, and press **ENTER**.

The GRMN/GRMN setting is a proprietary format that lets you exchange information such as waypoints, routes and track logs between two GARMIN GPS devices or a PC. During data transfer, the number of packets being exchanged will be displayed on screen.

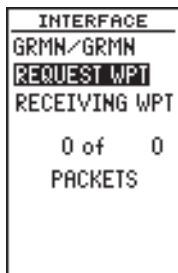

To select a transfer option:

1. Highlight the 'host' field and press **ENTER**.
2. Use **▲** and **▼** to select a setting and press **ENTER**.

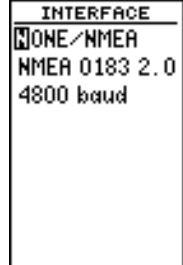

A field for additional information will be displayed when required for the selected interface option. Above, the None/NMEA option will allow input of NMEA versions and a baud rate.



Chose a 'HOST' field based upon the type of information transfer you want to occur between the two interfacing devices.

DGPS Interface

The 'NONE/NMEA?' setting makes it possible to output data to output information to devices like chart-plotters and autopilots.



The selectable baud rate is available for all RTCM interface options.

To disable all interfacing capabilities, select the None/None setting. If you want to output NMEA data to compatible external devices without any differential input capability, select the None/NMEA setting. Once a NMEA output setting has been selected (with or without RTCM input), the NMEA field will become highlighted. NMEA formats 0180, 0182 or 0183 (1.5 or 2.0) are available.

**To select a NMEA format:**

1. Press **ENTER** to begin a NMEA selection.
2. Use **▲** and **▼** to select a format, and press **ENTER**.

DGPS Interface

The last two format settings allow the differential-ready GPS 120XL to accept RTCM DGPS corrections in RTCM 104 version 2.0 format. Using DGPS corrections will improve receiver accuracy to 5-10 meters, regardless of errors induced by the U.S. government's Selective Availability (SA) program. The RTCM/NONE format will allow connection to any manually tuned beacon receiver by using the proper output interface. The baud rate is selectable from the GPS 120XL.

The RTCM/NMEA selection controls the GARMIN GBR-21 differential beacon receiver. Once a RTCM setting has been selected, the GPS 120XL will either automatically try to tune the last frequency and bit rate you selected or will switch to the default frequency of 304.0 kHz with a bit rate of 100 bps if no previous beacon has been tuned. You may also enter your own frequency and bit rate if desired.

DGPS Interface & System Setup

DGPS Interface (continued)

To enter a DGPS beacon frequency:

1. Highlight the 'freq' field and press **ENTER**.
2. Enter the desired frequency and press **ENTER**.
3. Highlight the 'rate' field and press **ENTER**.
4. Use **▲** and **▼** to select the desired transmission rate.
5. Press the **ENTER** key to confirm your entry.

When the GPS 120XL is receiving DGPS corrections from the GBR-21, the 'beacon receiver' section of the I/O setup page will display the beacon frequency and signal strength, as well as the distance from the transmitter to the beacon receiver. At the bottom of the beacon receiver field, a status message will keep you informed of DGPS activity:

- A 'Tuning' message will be displayed while a beacon signal is being tuned.
- Once the beacon signal has been tuned, a 'Receiving' message will be displayed.
- If a beacon signal is tuned and no corrections are being received, a 'No Data' message will be displayed.
- If a beacon signal cannot be tuned, a 'No Status' message will be displayed.

The GPS 120XL will also display one of three alert messages concerning DGPS operation through the message page:

No DGPS Position— not enough data is available to compute a DGPS position.

No RTCM Input— the beacon receiver is not properly connected or the baud rates do not match.

RTCM Input Failed— DGPS data was being received but has been lost.

```

INTERFACE
-----
RTCM/NMEA
NMEA 0183 2.0
4800 baud
-----
BEACON RECV
FREQ: 304.0KHz
RATE: 100bps
DIST  --.m
SNR   --dB
Tuning
  
```

Once a RTCM option is selected, you must manually tune the beacon receiver from the frequency field.

```

MESSAGES
-----
No DGPS
Position
-----
PRESS PAGE
  
```

Alert messages will signal any problems with DGPS operation.

Setting Time, Screen Contrast, & Tone

SYSTEM SETUP	
MODE:	Normal?
DATE	22 FEB 97
TIME	07:51:00pm
OFFSET:	-06:00
HOURS:	12
CONTRAST:	█
TOINE:	MSG, Key

The GPS 120XL's two operating modes are accessed through the system setup submenu.

SYSTEM SETUP	
MODE:	Simulator
DATE	22 FEB 97
TIME	07:51:16pm
OFFSET:	-06:00
HOURS:	12
CONTRAST:	█
TOINE:	MSG, Key

To display the correct local time, you must enter the appropriate offset from the chart at the end of Appendix C.

System Setup

MENU	
NEAREST WPTS	
WAYPOINT LIST	
WAYPOINT	
ROUTES	
DIST AND SUM	
TRACK LOG	
INTERFACE	
SYSTEM SETUP	
NAV SETUP	
MAP SETUP	
ALARMS SETUP	

The next setup page is the system setup page, which is used to select the operating mode, time offset and screen preferences. The GPS 120XL has two operating modes:

- **'Normal' Mode** operates the unit at maximum performance, and provides a battery of life up to 12 hours on alkaline batteries.
- **'Simulator' Mode** allows you to operate the unit without acquiring satellites, and is ideal for practicing or entering waypoints and routes while at home.

To select an operating mode:

1. Highlight the 'MODE' field and press **ENTER**.
2. Use the arrow keypad to select a mode and press **ENTER**.

Date and Time Setup

The date and time field is located directly below the mode field. Because the time shown is UTC time, you will need to enter a time offset to display the correct local time for your area. To determine the time offset for your area, note your position and refer to the chart in Appendix C.

To enter the time offset:

1. Highlight the 'OFFSET' field and press the **ENTER** key.
2. Enter the time offset and press **ENTER**. Remember to select a positive or negative indicator for your offset.

Navigation Setup

Time Format

The time display shown on the system setup and Position Pages may be set to display the time in a 12 or 24-hour format.

To select the time format:

1. Highlight the 'HOURS' field and press the **ENTER** key.
2. Select 12-or 24-hour display, and press **ENTER** to confirm.

Screen Contrast

The GPS 120XL features adjustable screen contrast and is controlled by using an on-screen bar scale.

To set the screen contrast:

1. Move the field highlight to the 'CONTRAST' field and press the **ENTER** key.
2. Use the **◀** and **▶** keys to adjust the bar scale for the desired contrast and press the **ENTER** key.

Tone Setting

SYSTEM SETUP
MODE: Simulator
DATE 03 JUL 97
TIME 17:59:52
OFFSET: +00:00
HOURS: 24
CONTRAST: ██████
TONE: None

You may choose from three settings for audible tone: messages only, messages and keystrokes, or no tone at all.

To specify a tone setting:

1. Highlight the 'TONE' field and press the **ENTER** key.
2. Use the **▲** and **▼** keys to select the desired tone and press **ENTER**.

SYSTEM SETUP
MODE: Simulator
DATE 03 JUL 97
TIME 06:00:36pm
OFFSET: +00:00
HOURS: 12
CONTRAST: ██████
TONE: MSG Only

Choose 24-hour (military) or 12-hour time display from the 'HOURS' field.

SYSTEM SETUP
MODE: Simulator
DATE 22 FEB 97
TIME 07:51:20pm
OFFSET: -06:00
HOURS: 12
CONTRAST: ██████
TONE: MSG, Key

Screen contrast may be adjusted to your lighting conditions with the contrast bar.

Navigation Setup

MENU
NEAREST HPTS
WAYPOINT LIST
WAYPOINT
ROUTES
DIST AND SUN
TRACK LOG
INTERFACE
SYSTEM SETUP
NAU SETUP
HAP SETUP
ALARMS SETUP

NAU SETUP
POSITION FRMT: hddd°mm.mmm'
MAP DATUM: WGS 84
CDI: ±0.25
UNITS: Nautical
SPEED FILTER: Auto
HEADING: Auto Mag E004

The position format may be set to display your choice of many formats. Note: degree and minutes is the default setting.

NAU SETUP
POSITION FRMT: hddd°mm.mmm'
MAP DATUM: European 1979
CDI: ±0.25
UNITS: Statute
SPEED FILTER: Auto
HEADING: Auto Mag E004

Use any of the 106 separate map datums to maximize the operation of the GPS 120XL with your specific map or chart.

Navigation Setup

The navigation setup page is used to select units of measurement for position format, map datum, CDI scale, and distance, speed and heading information.

Position Formats

The default position setting for the GPS 120XL is latitude and longitude in degrees and minutes (hddd°mm.mmm'). You may also select degrees, minutes and seconds (hddd°mm'ss.s"); degrees only (hddd.dddd°); UTM/UPS coordinates; or British, German, Irish, Maidenhead, Swedish, Swiss or Taiwan grid formats.

To select a position format:

1. Highlight the 'POSITION FRMT' field and press **ENTER**.
2. Use the **▲** and **▼** keys to select the desired setting. Confirm the setting by pressing **ENTER**.

Map Datums

The map datum field is located just below the position format field, and comes with a WGS 84 default setting. Although 104 total map datums are available for use (see the map datum listing in appendix B), you should only change the datum if you are using maps or charts that specify a different datum than WGS 84.

To select a map datum:

1. Highlight the 'MAP DATUM' field and press **ENTER**.
2. Use the **▲** and **▼** keys to toggle through and select the desired setting. Confirm the setting by pressing **ENTER**.

Units of Measure & Speed Filter

CDI Scale Settings

The course deviation indicator (CDI) scale definition field lets you select the +/- range of the CDI bar scale on the Highway Page. Three scales are available: +/- 0.25, 1.25 and 5.0 miles or kilometers, with 0.25 being the default setting.

To enter a CDI scale setting:

1. Highlight the 'CDI SCALE' field and press **ENTER**.
2. Use the **▲** and **▼** keys to select the desired setting.
3. Press the **ENTER** key to confirm the selection.

Units of Measure

The GPS 120XL lets you select nautical (default), statute or metric units of measure for all speed and distance fields.

To change the unit of measure:

1. Highlight the 'units' field and press the **ENTER** key.
2. Use **▲** and **▼** to select the desired unit of measure.
3. Press the **ENTER** key to confirm the selection.

Speed Filter

NAV SETUP
POSITION FRMT: hddd°mm. mmm'
MAP DATUM: WGS 84
CDI: ±0.25
UNITS: Statute
SPEED FILTER: Auto
HEADING: Auto Mag E004

NAV SETUP
POSITION FRMT: hddd°mm. mmm'
MAP DATUM: WGS 84
CDI: ±0.25
UNITS: Nautical
SPEED FILTER: Auto
HEADING: Auto Mag E004

Adjusting the CDI Scale will determine the value used in the Highway Page and for the range rings on the Map Page (if displayed).

NAV SETUP
POSITION FRMT: hddd°mm. mmm'
MAP DATUM: WGS 84
CDI: ±0.25
UNITS: Statute
SPEED FILTER: Auto
HEADING: Auto Mag E004

Choose a navigation unit you are familiar with or that may be appropriate to the situation in which the GPS 120XL is used.

Speed Filter & Magnetic Heading

NAU SETUP
POSITION FRMT: hddd°mm.mmm'
MAP DATUM: WGS 84
CDI: ±0.25
UNITS: Statute
SPEED FILTER: On 030 SEC
HEADING: User Mag:E000

Setting the speed filter to 'On' makes it possible for you to select the receiver's time response to changes in track or ground speed.

NAU SETUP
POSITION FRMT: hddd°mm.mmm'
MAP DATUM: WGS 84
CDI: ±0.25
UNITS: Nautical
SPEED FILTER: On 012 SEC
HEADING: Auto Mag E004

The number entered represents a window of time the GPS 125 Sounder considers in adjusting to changes in speed and track. For example, if 12 seconds is entered, the speed displayed will constantly represent the speed averaged over the last 12 seconds.

Speed Filter (continued)

The speed filter allows you to determine how the GPS 120XL responds to changes in track or ground speed. Three settings are available: automatic, on, or off. The 'Auto' setting is the default and will monitor the changes in your current track and speed and adjust the receiver's response time automatically. The 'On' setting allows you to manually enter a response time up to 300 seconds. Selecting a higher setting may be desirable in slow-speed applications with frequent changes in track.

To enter a value for the speed filter:

1. Highlight the 'SPEED FILTER' field and press **ENTER**.
2. Select the 'ON' option and press **ENTER**.
3. Highlight the "speed value" field and press the **ENTER** key.
4. Use **▲** and **▼** to select the desired number of seconds.
5. Press the **ENTER** key to confirm the selection.

Magnetic Heading Reference

The GPS 120XL's heading information can be displayed referencing magnetic north (auto or user-defined), true north or calculated grid headings. The default setting is automatic magnetic north, which is suitable for most applications.

NAU SETUP
POSITION FRMT: hddd°mm.mmm'
MAP DATUM: WGS 84
CDI: ±0.25
UNITS: Statute
SPEED FILTER: Off
HEADING: True

Magnetic Heading & Map Setup

Magnetic Heading Reference (continued)

To select a heading reference:

1. Highlight the 'HEADING' field and press **ENTER**.
2. Select the desired heading preference.
3. Press the **ENTER** key to confirm the selection.

To enter a user-defined magnetic heading:

1. Select the 'USER MAG' option and press **ENTER**.
2. Use the **▲** and **▼** keys to enter the degrees and direction of magnetic variation.
3. Press the **ENTER** key to confirm the magnetic variation value.

Map Setup and Orientation

The map setup page lets you select map orientation and specify what items are displayed. The map may be oriented to north up, the direction of current travel (track up) or the direction of an active route leg (desired track up). The default setting is track up.

To change the map orientation:

1. Highlight the 'ORIENTATION' field and press **ENTER**.
2. Use the **▲** and **▼** keys to toggle through and select the desired setting, and press **ENTER**.

Selecting Displayed Items on the Map Page

The rest of the map setup page lets you specify what items are displayed or plotted on the Map Page. The first four plot items may be turned on or off by selecting 'yes' or 'no' in the appropriate field:

- The 'RINGS' selection will display the three present position range rings on the map.
- The 'ROUTE' selection will plot the straight leg lines between waypoints of an active route and display all route waypoint names.

NAV SETUP
POSITION FRMT: hddd°mm.mmm'
MAP DATUM: WGS 84
CDI: ±0.25
UNITS: Statute
SPEED FILTER: Off
HEADING: User Mag:W000

To enter a user-defined magnetic variation, select the 'User Mag' option and enter the desired direction and value.

MAP SETUP
ORIENTATION: North Up
PLOTTED ITEMS
RINGS: No
ROUTE: Yes
NEAREST: Yes
NAMES: Yes
TRACK LOG: 250

The 'North Up' orientation causes the top-center of the Map Page to represent 000°, the right-center to be 090°, the bottom-center 180°, and the left-center to be 270°.

Map Page Setup & Track Log Display

MAP SETUP	
ORIENTATION:	Track Up
PLOTTED ITEMS	
RINGS:	Yes
ROUTE:	No
NEAREST:	No
NAMES:	Yes
TRACK LOG:	250

On-screen range rings will appear on the map when the 'RINGS' option is set to the 'Yes' position.

MAP SETUP	
ORIENTATION:	Track Up
PLOTTED ITEMS	
RINGS:	No
ROUTE:	Yes
NEAREST:	Yes
NAMES:	Yes
TRACK LOG:	150

The screen resolution of the track log may be changed by increasing the number of tracklog points displayed. However, displaying too many points may clutter your screen .

Selecting Displayed Items on the Map Page (cont.)

- The 'NEAREST' selection will display the nine nearest waypoints to your present position (not to the target cursor on the map).
- The 'NAMES' selection will display the waypoint name for the nine nearest waypoints.

To turn a plotted item on or off:

1. Highlight the confirmation (Yes or No) field for the plotted item and press **ENTER**.
2. Use ▲ or ▼ to select 'Yes'/'No', and press **ENTER**.

Track Log Display

The track log option sets the number of points the unit will attempt to display on the Map Page. The default setting of 250 points provides good resolution with minimal screen clutter. The maximum setting is 768 points. Once the maximum number of track points is reached, the older points will be lost as new points are added. Note that adjusting the points displayed will not affect whether or not the receiver records a track log or the ability to create a TracBack route.

To enter a log setting:

1. Highlight to the 'track log' field and press **ENTER**.
2. Enter a value in the 3-digit field and press **ENTER**. If you do not want to display a track, enter '000'.

Alarms Setup

MENU
NEAREST WPTS
WAYPOINT LIST
WAYPOINT
ROUTES
DIST AND SUN
TRACK LOG
INTERFACE
SYSTEM SETUP
NAV SETUP
MAP SETUP
ALARMS SETUP

The alarms setup page is used to set the three alarms available on the GPS 120XL: the anchor drag alarm, arrival alarm, and CDI alarm.

The anchor drag alarm will sound if your boat has moved outside a range measured from a central point (your position). The arrival alarm sounds when you are approaching a waypoint and have reached the user defined distance. The CDI alarm will alert you when your track varies from the shortest distance to a waypoint by the defined range.

The arrival and CDI alarms may be set from 0.0 to 9.9 units. The anchor drag alarm may be set up to 9.99 distance units.

To set the alarms:

1. Move the highlight to 'ALARMS SETUP' and press **ENTER**.
2. Select the desired alarm distance field and press **ENTER**.
3. Enter the distance for the alarm and press **ENTER**.
4. If you would like to change the 'On/Off' setting, press the **ENTER** key and use the **▲** and **▼** keys to turn the alarm on or off.
5. Enter a setting and press the **ENTER** key.



When setting the anchor drag alarm, remember that Selective Availability can degrade your GPS position as much as 100 meters and may cause false anchor drag alerts.

Alarms Setup

ALARMS SETUP	
Anchor Drag:	0.00 <input type="checkbox"/> Off
Arrival:	1.0 <input checked="" type="checkbox"/> On
CDI Alarm:	0.1 <input type="checkbox"/> Off

When activated, the arrival alarm will sound when you reach the specified distance from your destination waypoint.

ALARMS SETUP	
Anchor Drag:	0.00 <input type="checkbox"/> Off
Arrival:	1.0 <input type="checkbox"/> On
CDI Alarm:	0.1 <input checked="" type="checkbox"/> On

Use the CDI alarm to ensure you maintain a straight-line course to the destination waypoint.

Nav Simulator

SYSTEM SETUP
MODE: Simulator
DATE 22 FEB 97
TIME 07:53:48pm
OFFSET: -06:00
HOURS: 12
CONTRAST: █
TONE: MSG, Key

Select the simulator mode from the operation mode choices and press ENTER. You may return to normal operation by changing the operation mode or by turning the unit off.

Navigation Simulator

The GPS 120XL's simulator mode lets you practice all aspects of its operation without active satellite acquisition. You can also plan and practice trips, enter new waypoints and routes, and save them for use during normal operation. The simulator is activated from the system setup page, with speed and heading controlled from the Position, Compass or Highway Pages.

To activate the simulator:

1. Highlight 'SYSTEM SETUP' and press **ENTER**.
2. Highlight the 'MODE' field and press **ENTER**.
3. Use **▲** or **▼** to select the simulator mode and press **ENTER**.
4. Press **ENTER** to return to the Menu Page.

Once the simulator mode has been activated, use the Position, Compass or Highway Page to set your speed and track. You may also enter a new position if you desire (only from the Position Page).

To enter track, speed and position:

1. Highlight the 'TRACK' field and press the **ENTER** key.
2. Enter a track heading and press **ENTER**.
3. Highlight the 'SPEED' field and press **ENTER**.
4. Enter a speed and press **ENTER**.
5. Highlight the 'POSITION' field (Position Page only) and press **ENTER**.
6. Enter a position and press the **ENTER** key.



The GPS 120XL does not track satellites in simulator mode. Although you can create and save waypoints and routes while using the simulator mode, never attempt to use the simulator mode for actual navigation.

Installation

The GPS 120 XL must be properly installed according to the following instructions to get the best possible performance.

To complete the standard installation, you will need the following pieces:

- 1 amp in-line fuse (may be included with Power/Datacable)
- Four 1/4" (6mm) diameter mounting screws
- 1" x 14 marine antenna mount and screws

Several optional accessories are also available to provide flexible installation on any vessel. See your GARMIN dealer for more information on these items:

- AC Adapter
- Antenna Cable Extension
- Cigarette Lighter Adapter

To begin installation, you'll need to select a suitable mounting position for the antenna and the unit. Once you've identified the best mounting location, install the antenna and cable first, then the unit and wiring harness.

Mounting the GPS antenna

The antenna should be mounted in a location that has a clear, unobstructed view of the sky in all directions to ensure the best reception in all conditions. Avoid mounting the antenna where it will be shaded by the boat's superstructure, a radome antenna, or mast. Most marine VHF and loran antennas will not seriously degrade the GPS antenna's reception. Never paint the antenna or clean it with harsh solvents.

To install the GPS antenna:

1. Screw the antenna directly onto the 1" – 14 mount.
2. Route the cable to the location of the display unit, using the appropriate tie-wraps, escutcheon plates and sealant to secure the cable along the route and through any bulkhead or deck.
3. Once the GPS 120XL unit has been installed, connect the cable to the antenna connector on the back of the display unit. Turn the antenna connector 1/4 turn clockwise to lock the cable into place.

Mounting the GPS 120XL

The GARMIN GPS 120XL's compact case is suitable for mounting in exposed locations or at the nav station. The unit comes with a gimbal bracket that can be used for surface, overhead, or flush mounting. When choosing a location for the display unit, make sure you consider the following conditions:

- There should be at least 2.00" (5.0 cm) clearance behind the case to allow connection of the antenna and power/data cables.
- The mounting surface should be rigid enough to support the unit and protect it from excessive vibration and shock.

To surface mount the GPS 120XL:

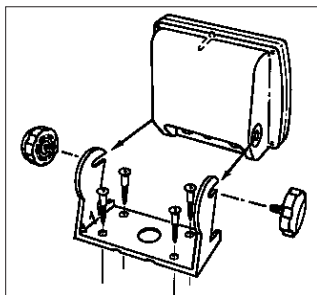

1. Place the mounting bracket in the desired location.
2. Mark and drill the four mounting holes for the fasteners you are using.
3. Fasten the bracket to the surface using the appropriate fasteners.
4. Insert the GPS 120XL into the mounting bracket.
5. Screw the two mounting knobs through the bracket and into the GPS 120XL.
6. Connect the power/data and antenna cables to the back of the unit, making sure the locking rings are fully tightened on both connectors.

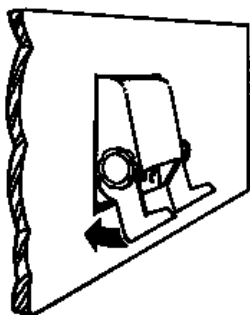
To flush mount the GPS 120XL:

The GPS 120XL can be mounted flush with a flat panel of .08-.52" thickness using the cam lobe feature on its mounting bracket.

1. Cut a 4.15" W x 4.67" H hole in panel.
2. Place GPS 120XL into hole from the front until its flange rests against the mounting surface.
3. From the back side of the panel, loosely attach the bracket such that the slot in the ratchet area points away from the mounting panel.
4. Rotate the bracket downward until the panel is pinched tightly between the units flange and bracket lobe.
5. Tighten knobs and connect the power/data and antenna cables. *Note: If the panel is too thick to allow use of the knobs supplied, use two M6 screws to secure the bracket.*

Connecting the power/data cable

The power/data cable connects the GPS 120XL system to a 10-40 volt DC power source and provides interface capabilities for connecting NMEA devices and an external alarm. The diagram below indicates the appropriate harness connections.

To connect the GPS 120XL to a power source:

1. Connect the RED harness lead to the positive side of a 10-40 volt DC power source. Make sure the power lead has an in-line 1-amp fuse installed.
2. Connect the BLACK harness lead to a ground strip or the negative side of a 10-40 volt DC power source.

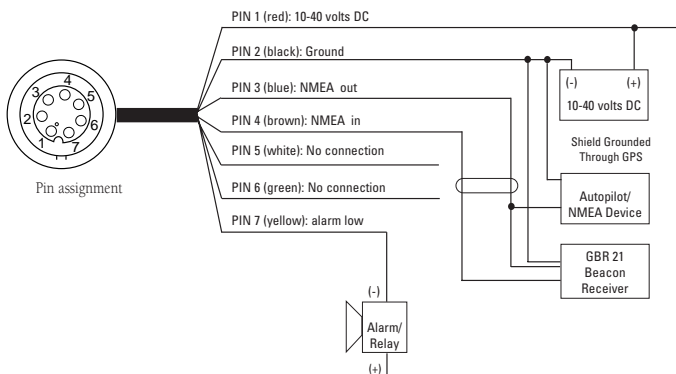

To connect an external alarm, connect the ground side of the alarm device to the YELLOW harness lead. (100 mA DC load max.) The following interface formats are supported by the GPS 120XL for driving three NMEA devices:

NMEA 0180, NMEA 0182,

NMEA 0183 version 1.5:

Approved sentences:

GPBWC, GPGLL, GPRMB, GPRMC, GPXTE,
GPVTG, GPWPL

Proprietary sentences:

PGRMM (map datum), PGRMZ
(altitude), PSLIB (beacon rec. control)

NMEA 0183 version 2.0:

Approved sentences:

GPGGA, GPGLL, GPGSA, GPGSV,
GPRMB, GPRMC, GPRTE, GPWPL

Proprietary sentences:

PGRME (estimated error), PGRMM (map
datum), PGRMZ (altitude), PSLIB (beacon
receiver control)

The GPS 120XL is constructed of high quality materials and should not require user maintenance. Should your unit ever need repair, please take it to an authorized GARMIN service center. The GPS 120XL has no user serviceable parts. Never attempt any repairs yourself.

To protect your GPS, never allow gasoline or other solvents to come in contact with the case or screen. Clean the case and screen with a soft cloth and a household window cleaner.

PHYSICAL

Case:	Gasketed construction
Size:	4.9"H x 5.3"W x 2.4"D (15.6 x 5.1 x 1.23 cm)
Weight:	Less than 1 lb. (454g)
Temperature Range:	5° to 158°F (-15° to 70°C)

PERFORMANCE

Receiver:	Differential-ready MultiTrac8
Acquisition Time:	Approx. 20 seconds (warm) Approx. 2 minutes (cold) Approx. 7.5 minutes (AutoLocate)
Update Rate:	1/second, continuous
Position Accuracy:	5-10 meters (16-33 ft.) with DGPS corrections* 15 meters (49 ft.) RMS**
Velocity Accuracy:	0.1 knot RMS steady state, 99 knots max.
Dynamics:	Performs specification to 3g's

POWER

Input:	10-40v DC
Usage:	2 watts

Specifications subject to change without notice

* With optional GARMIN GBR 21 Beacon Receiver Input.

** Subject to accuracy degradation to 100m 2DRMS under the U.S. DOD-imposed Selective Availability Program.

*Messages &
Time Offsets*

The GPS 120XL uses a flashing on-screen message to alert you to important information. Whenever the message indicator appears, press the PAGE key to view the message page. There are two types of messages: temporary alerts and condition alerts. Temporary alerts are cleared from the message page after viewing, while condition alerts remain on the message page until the condition has been resolved. Pay careful attention to all messages for your own safety.

Active WPT Can't be Deleted—You have attempted to change the “active to” or “active from” waypoint. Clear the active route or GOTO before making your changes.

Accuracy has been Degraded—The accuracy of the GPS 120XL has been degraded beyond 500 meters due to poor satellite geometry or data quality. You should check other navigational sources to verify the position indicated.

Already Exists—The name you are entering already exists in the GPS 120XL's memory.

Approaching—You are one minute away from reaching a destination waypoint.

Battery Power is Low—The batteries are low and should be replaced.

No DGPS Position—Not enough data is available to compute a DGPS position.

No RTCM Input—Beacon receiver is improperly connected or baud rates do not match.

Poor GPS Coverage—The GPS 120XL cannot acquire the necessary number of satellites to compute a position. Try another location with a clearer view of the sky.

Power Down and Re-init—The GPS 120XL is not able to calculate a position due to abnormal satellite conditions. Turn the unit off and verify the last position shown by other means. Try the unit again later, possibly in a different location.

Read Only Mem has Failed—The permanent memory has failed and the unit is not operable. Take your unit to an authorized GARMIN dealer for repairs.

Received an Invalid WPT—A waypoint was received during upload transfer that has an invalid identifier.

Receiver has Failed—A failure in receiver hardware has been detected. If this message persists, do not use the unit and take it to an authorized dealer for repair.

Route is Full—You have attempted to add more than 30 waypoints to a route.

Route is not Empty—You have attempted to copy into a route already in use.

Route Waypoint Can't be Deleted—The waypoint you are trying to delete is part of a route. Delete the waypoint from the route before removing it from memory.

Route Waypoint was Deleted—A route waypoint entered does not exist in the database and has been deleted from the route.

RTCM Input has Failed—DGPS data being received has been lost. You are no longer receiving the beacon signal.

Searching the Sky—The GPS 120XL is in searching the sky for almanac data or the unit is in AutoLocate™ mode.

Messages & Time Offsets

Route Waypoint was Deleted—A route waypoint entered does not exist in the database and has been deleted from the route.

RTCM Input has Failed—DGPS data being received has been lost. You are no longer receiving the beacon signal.

Searching the Sky—The GPS 120XL is searching the sky for almanac data or the unit is in AutoLocate™ mode.

Stored Data was Lost—All waypoints, routes, time and almanac data have been lost due to battery failure or clearing the receiver's memory.

Transfer has been Completed—The receiver is finished uploading or downloading information to the connected device.

WPT Memory is Full—You have used all 250 waypoints in the GPS 120XL. Delete unwanted waypoints to make room for new entries.

The chart below gives the UTC time offset for the various longitudinal zones. If you are in daylight savings time, add one hour to the offset.

Longitudinal Zone	Offset	Longitudinal Zone	Offset
W180.0° to W172.5°	-12	E007.5° to E022.5°	1
W172.5° to W157.5°	-11	E022.5° to E037.5°	2
W157.5° to W142.5°	-10	E037.5° to E052.5°	3
W142.5° to W127.5°	-9	E052.5° to E067.5°	4
W127.5° to W112.5°	-8	E067.5° to E082.5°	5
W112.5° to W097.5°	-7	E082.5° to E097.5°	6
W097.5° to W082.5°	-6	E097.5° to E112.5°	7
W082.5° to W067.5°	-5	E112.5° to E127.5°	8
W067.5° to W052.5°	-4	E127.5° to E142.5°	9
W052.5° to W037.5°	-3	E142.5° to E157.5°	10
W037.5° to W022.5°	-2	E157.5° to E172.5°	11
W022.5° to W007.5°	-1	E172.5° to E180.0°	12
W007.5° to E007.5°	0		

Map Datums

The following list shows the 104 map datums available for the GPS 120XL. Menu Page abbreviations are listed first, followed by the corresponding map datum name and area.

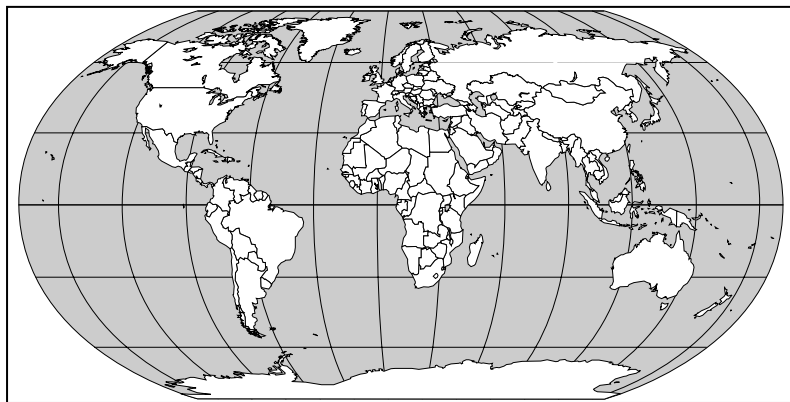

Adindan	Adindan- Ethiopia, Mali, Senegal, Sudan	Bogata Observ	Bogata Observatry- Colombia
Afgoooye	Afgoooye- Somalia	Campo Inchspe	Campo Inchauspe- Argentina
AIN EL ABD '70	AIN EL ANBD 1970- Bahrain Island, Saudi Arabia	Canton Ast '66	Canton Astro 1966- Phoenix Islands
Anna 1 Ast '65	Anna 1 Astro '65- Cocos Isl.	Cape	Cape- South Africa
ARC 1950	ARC 1950- Botswana, Lesotho, Malawi, Swaziland, Zaire, Zambia, Zimbabwe	Cape Canavrl	Cape Canaveral- Florida, Bahama Islands
ARC 1960	ARC 1960- Kenya, Tanzania	Carthage	Carthage- Tunisia
Ascnsn Isl'd '58	Ascension Island '58- Ascension Island	CH-1903	CH 1903- Switzerland
Astro B4 Sorol	Astro B4 Sorol Atoll- Tern Island	Chatham 1971	Chatham 1971- Chatham Island (New Zealand)
Astro Bcn "E"	Astro Beacon "E"- Iwo Jima	Chua Astro	Chua Astro- Paraguay
Astro Dos 71/4	Astro Dos 71/4- St. Helena	Corrego Alegr	Corrego Alegre- Brazil
Astr Stn '52	Astronomic Stn '52- Marcus Island	Djakarta	Djakarta (Batavia)- Sumatra Island (Indonesia)
Astrln Geod '66	Australian Geod '66- Australia, Tasmania Island	Dos 1968	Dos 1968- Gizo Island (New Georgia Islands)
Astrln Geod '84	Australian Geod '84- Australia, Tasmania Island	Easter Isl'd 67	Easter Island 1967
Bellevue (IGN)	Efate and Erromango Islands	European 1950	European 1950- Austria, Belgium, Denmark, Finland, France, Germany, Gibraltar, Greece, Italy, Luxembourg, Netherlands, Norway, Portugal, Spain, Sweden, Switzerland
Bermuda 1957	Bermuda 1957- Bermuda Islands		

Map Datums

European 1979	European 1979- Austria, Finland, Netherlands, Norway, Spain, Sweden, Switzerland	Massawa	Massawa- Eritrea (Ethiopia)
Finland Hayfrd	Finland Hayford- Finland	Merchich	Merchich- Morocco
Gandajika Base	Gandajika Base- Republic of Maldives	Midway Ast '61	Midway Astro '61- Midway
Geod Datm '49	Geodetic Datum '49- New Zealand	Minna	Minna- Nigeria
Guam 1963	Guam 1963- Guam Island	NAD27 Alaska	North American 1927- Alaska
Gux 1 Astro	Gux 1 Astro- Guadalcanal Island	NAD27 Bahamas	North American 1927- Bahamas (excluding San Salvador Island)
Hjorsey 1955	Hjorsey 1955- Iceland	NAD27 Canada	North American 1927- Canada and Newfoundland
Hong Kong '63	Hong Kong '63- Hong Kong	NAD27 Canal Zone	North Am. 1927- Canal Zone
Hu-Tzu-Shan	Hu-Tzu-Shan- Taiwan	NAD27 Caribbn	North American 1927- Caribbean (Barbados, Caicos Islands, Cuba, Dom. Rep., Grand Cayman, Jamaica, Leeward and Turks Islands)
Indian Bngldsh	Indian- Bangladesh, India, Nepal	NAD27 Central	North American 1927- Central America (Belize, Costa Rica, El Salvador, Guatemala, Honduras, Nicaragua)
Indian Thailand	Indian- Thailand, Vietnam	NAD27 CONUS	North Am. 1927- Mean Value (CONUS)
Indonesia '74	Indonesia 1974- Indonesia	NAD27 Cuba	North American 1927- Cuba
Ireland 1965	Ireland 1965- Ireland	NAD27 Grnland	North American 1927- Greenland (HayesPeninsula)
ISTS 073 Astro	ISTS 073 ASTRO '69- Diego Garcia	NAD27 Mexico	N. American 1927- Mexico
Johnston Island	Johnston Island Kandawala Kandawala- Sri Lanka	NAD27 San Sal	North American 1927- San Salvador Island
Kerguelen Islnd	Kerguelen Island	NAD83	North American 1983- Alaska, Canada, Central America, CONUS, Mexico
Kertau 1948	Kertau 1948- West Malaysia, Singapore		
L. C. 5 Astro	Cayman Brac Island		
Liberia 1964	Liberia 1964- Liberia		
Luzon Mindanao	Luzon- Mindanao Island		
Luzon Philippine	Luzon- Philippines (excluding Mindanao Island)		
Mahe 1971	Mahe 1971- Mahe Island		
Marco Astro	Marco Astro- Salvage Island		

Map Datums

Nhrwn Masirah	Nahrwn- Masirah Island (Oman)	Sapper Hill '43	Sapper Hill 1943- East Falkland Island
Nhrwn Saudi A	Nahrwn- Saudi Arabia	Schwarzeck	Schwarzeck- Namibia
Nhrwn United A	Nahrwn- United Arab Emirates	Sih Amrcn '69	South American '69- Argentina, Bolivia, Brazil, Chile, Colombia, Ecuador, Guyana, Paraguay, Peru, Venezuela, Trinidad and Tobago
Naparima BWI	Naparima BWI- Trinidad and Tobago	South Asia	South Asia- Singapore
Obsrvtorio '66	Observatorio 1966- Corvo and Flores Islands (Azores)	SE Base	Southeast Base- Porto Santo and Madiera Islands
Old Egyptian	Old Egyptian- Egypt	SW Base	Southwest Base- Faial, Graciosa, Pico, Sao Jorge and Terceira Islands (Azores)
Old Hawaiian	Old Hawaiian- Mean Value	Timbalai 1948	Timbalai 1948- Brunei and E. Malaysia (Sarawak and Sabah)
Oman	Oman- Oman	Tokyo	Tokyo- Japan, Korea, Okinawa
Ord Srvy GB	Old Survey Grt Britn- England, Isle of Man, Scotland, Shetland Isl., Wales	Tristan Ast '68	Tristan Astro 1968- Tristan da Cunha
Pico De Las Nv	Canary Islands	Viti Levu 1916	Viti Levu 1916- Viti Levu/ Fiji Islands
Pitcairn Ast '67	Pitcairn Astro '67- Pitcairn Isl.	Wake-Eniwetok	Wake-Eniwetok- Marshall Isl.
Prov S Am '56	Prov So Amrcn '56- Bolivia, Chile, Colombia, Ecuador, Guyana, Peru, Venezuela	WGS 72	World Geodetic System 1972
Prov S Chln '63	Prov So Chilean '63- S. Chile	WGS 84	World Geodetic System 1984
Puerto Rico	Puerto Rico & Virgin Islands	Zanderij	Zanderij- Surinam
Qatar National	Qatar National- Qatar		
Qornoq	Qornoq- South Greenland		
Reunion	Reunion- Mascarene Island		
Rome 1940	Rome 1940- Sardinia Island		
RT 90	Sweden		
Santo (Dos)	Santo (Dos)- Espirito Santo Island		
Sao Braz	Sao Braz- Sao Miguel, Santa Maria Islands (Azores)		

*Index***A**

Activating and Inverting Routes . . .	32
Active Route Page	32
Alarms Setup	53
Almanac Data	2
Altitude Display	18
Anchor Drag Alarm	53
Arrival Alarm	53

B

Backlighting	18
Bearing	2

C

CDI Alarm	53
CDI Scale Settings	49
Cancelling a GOTO	15
Caution	iv
Clearing a Cluttered Map Display . . .	15
Compass Page	37
Copying and Clearing Routes	31
Course Made Good (CMG)	2
Creating and Navigating Routes . . .	29
Crosstrack Error (XTE)	2

D

DGPS Interface	44
Date and Time Setup	46
Desired Track (DTK)	2
Differential GPS (DGPS)	2
Distance and Sun Calculation	41

E

EZinit Option	17
Editing Existing Waypoints	24
Editing Routes	33
Estimated Time Enroute (ETE)	2
Estimated Time of Arrival (ETA)	2

G

GPS Antenna	55
Getting Started Tour	10
Glossary	2
Going To a Waypoint (GOTO)	13
Grid	3
Ground Speed	3

H

Highway Page	36
------------------------	----

I

Index	65
Initialization Troubleshooting	7
Initializing	5
Installation	56
Interface Setup	43

L

Latitude	3
Longitude	3

M

Magnetic Heading Reference	50
Man Overboard Function	26
Managing/Clearing the Track Log	42
Map Datums	48, 62
Map Page	9, 38
Map Setup and Orientation	51
Marking a Waypoint	10
Mark & GOTO Wpts W/Cursor	40
Marking and Saving Waypoints	19
Menu Page	9, 41
Message Page	41
Messages & Time Offsets	60
Mounting the GPS 120XL	56

N

Navigation	3
Navigation Basics	4
Navigation Page	9
Navigation Setup	48
Navigation Simulator	10, 54
Nearest Waypoints Page	20

*Index***O**

On-Route GOTOs	34
Overview	.iii

P

Packing List	.iii
Position	.3
Position Formats	.48
Position Page	.8, 18
Power/Data Cable	.58
Primary Pages	.8

R

Receiver Status and EPE	.17
Reference Waypoints	.23
Renaming and Deleting Waypoints	24
Route Definition Page	.30

S

Satellite Page	.8, 16
Scanning Waypoints	.25
Screen Backlighting	.18
Screen Contrast	.47
Selecting a GOTO Destination	.26
Signal Strength Bars	.16
Sky View	.16
Speed Filter	.49
System Setup	.46

T

Table of Contents	.1
Time Format	.47
Tone Setting	.47
TracBack	.27, 43
TracBack Tips	.28
Track (TRK)	.3
Track Criteria	.42
Track Log Display	.52

Track Log Setup Page	.42
Trip Odometer	.18

U

Units of Measure	.49
User-Defined Navigation Pages	.34
Using the Compass Page	.37
Using the Highway Page	.36
Using the Position and Map Pages	11
UTM Coordinates	.3

V

Velocity Made Good (VMG)	.3
--------------------------	----

W

Warranty	.67
Waypoint	.3
Waypoint Comments	.24
Waypoint Definition Page	.22
Waypoint List Page	.21
Waypoint Submenus	.20
Wiring & Specifications	.58

Z

Zooming, Panning, and Pointing	.39
--------------------------------	-----

LIMITED WARRANTY

GARMIN Corporation warrants this product to be free from defects in materials and workmanship for one year from the date of purchase. GARMIN will at its sole option, repair or replace any components which fail in normal use. Such repairs or replacement will be made at no charge to the customer for parts or labor. The customer is, however, responsible for any transportation costs. This warranty does not cover failures due to abuse, misuse, accident or unauthorized alteration or repairs. GARMIN assumes no responsibility for special, incidental, punitive or consequential damages, or loss of use.

The warranties and remedies contained herein are exclusive and in lieu of all other warranties expressed or implied, including any liability arising under warranty of merchantability or fitness for a particular purpose, statutory or otherwise. This warranty gives you specific legal rights, which may vary from state to state.

To obtain warranty service, call the GARMIN Customer Service department (913-397-8200) for a returned merchandise tracking number. The unit should be securely packaged with the tracking number clearly marked on the outside of the package, and sent freight prepaid and insured to a GARMIN warranty service station. A copy of the original sales receipt is required as the proof of purchase for warranty repairs. GARMIN retains the exclusive right to repair or replace the unit or software at its sole discretion.



© 1997 GARMIN Corporation

1200 E. 151st Street, Olathe, KS USA 66062

GARMIN (Europe) Ltd. - Unit 5, The Quadrangle,
Abbey Park, Romsey, UK SO51 9AQ

Part Number 190-00136-00 Rev. B Printed in Taiwan