

Bluetooth GPS User Manual

GPS GBT708

Version 1.01 2004 / 09 / 26

INDEX

1. OVERVIEW	3
2. PRODUCT FEATURE	3
3. SPECIFICATION.....	4
3.1. BASIC SPECIFICATION.....	4
3.2. ACQUISITION TIME (AVERAGED).....	4
3.3. RECEIVER ACCURACY	4
3.4. USE LIMITATION	4
3.5. POWER SUPPLY	5
3.6. OUTPUT AND INTERFACE	5
3.7. PHYSICAL	6
3.8. OTHER FUNCTIONS.....	6
4. HARDWARE	7
4.1. DIMENSION	7
4.2. HARDWARE DESCRIPTION	8
4.3. LED STATUS.....	8
4.4. POWER SWITCH.....	9
4.5. OPTIONAL ACCESSORIES, AND CONNECTOR DESCRIPTION	9
4.6. EXTERNAL ACTIVE ANTENNA CONNECTOR.....	10
4.7. POWER JACK & DATA PORT.....	10
5. SOFTWARE.....	11
5.1. SOFTWARE INSTALLATION	11
6. WARRANTY.....	12
7. HOW TO USE.....	14
7.1. CHARGE BATTERY	14
7.2. TURN ON POWER	14
8. TROUBLE SHOOTING	15

1. OVERVIEW

Altina **GBT708** Bluetooth wireless GPS Receiver is a total solution GPS receiver with Bluetooth, UART interface and built-in rechargeable battery for high sensitivity to tracking signal. **GBT708** is a dual-function GPS receiver. Not only transmit satellite information through the PDA or Notebook with Bluetooth interfaces but also G-Mouse GPS receiver through a data cable.

GBT708 provide you various applications such as car navigation, mapping, surveying, security, agriculture and so on. **GBT708** communicates with other device through Bluetooth wireless function and compatible interface of RS-232 or USB. Indeed, built-in rechargeable Lithium-ion battery offer you a convenient use in drive and also can save satellite information such as the status of satellite signal, the last location, date and time for last use.

With low power consumption, the **GBT708** can track up to 12 satellites at a time, and re-acquires satellite signals in 100 ms and updates position data every second. Trickle-Power allows the unit operates a fraction of the time and Push-to-Fix permits user to have a quick position fix even though the receiver usually stays off.

2. PRODUCT FEATURE

- Built in SiRF Star IIe/LP Low power consumption chipset
- 12 parallel satellite-tracking channels for fast acquisition and reacquisition
- High speed signal acquisition using 1920 time/frequency search channels
- Built-in WAAS/EGNOS Demodulator without any additional hardware
- Compatible with Bluetooth Serial Port Profile (SPP) completely
- Built-in rechargeable Lithium-ion battery without external power supply
- Provide Continued mode and Power Saving mode for user's requirement
- Provide expand terminal contact to other system without Bluetooth device
- Built-in rechargeable battery for memory and RTC backup and for fast Time To First Fix (TTFF)
- Support NMEA0183 v2.2 data protocol and SiRF binary code
- 4 colors LED to indicate the status of device
- Extra active antenna connecting port for getting better satellites signal
- FLASH based program memory. New software revisions upgradeable through serial interface.

- Small, sleek, and lightweight design easily fits on your hand
- Enhanced algorithms -SnapLock and SnapStart provide superior navigation, performance in urban, canyon and foliage environments.
- For Car navigation, Marine navigation, Fleet management, AVL, Personal navigation, Tracking System, and Mapping device application.

3. SPECIFICATION

3.1. Basic Specification

- Chipset : SiRF Star IIe/LP chipset.
- Channels : 12 parallel satellite-tracking channels.
- Frequency : 1575.42 MHZ.
- Receiver : L1, C/A code.

3.2. Acquisition Time (averaged)

- Reacquisition : 0.1sec.
- Snap start : < 3 seconds (at < 25 minutes off period)
- Cold start : < 45 seconds.
- Warm start : < 38 seconds .
- Hot start : < 8 seconds
- Update rate : 1 second continuously

3.3. Receiver Accuracy

- Normal : 5-25 meters CEP without SA
- Enable EGNOS or WAAS :
 - Position < 2.2 meters, horizontal 95% of time
 - Position < 5 meters, Vertical 95% of time
- Velocity : within 0.1 meters / second
- Time : 1 microsecond synchronized GPS time

3.4. Use Limitation

- Altitude : < 18,000 meters (60,000 feet)
- Velocity : < 515 meters / second (700Knots)
- Acceleration : 4G
- Jerk : 20 meters / second, max

3.5. Power Supply

- External Voltage: 5VDC +/- 10%
- Batteries :
 - Main Power: Built-in rechargeable Lithium-ion for system power
- Backup Power: Rechargeable Lithium-ion battery for memory & RTC backup
- Working voltage:
 - Normal Mode: 80-90mA
 - Power Saving Mode: 30mA
- Working period (In Battery full power status):
 - Continued Mode: 9 hours
 - Power Saving Mode: 16 hours

【NOTE】 GBT-708 has built Li-battery inside, please avoid closing high temperature environment or sun shine directly for a long time.

3.6. Output and Interface

➤ Output

I. Output protocol

- ◆ Baud Rate : 9600 bps
- ◆ Data bit : 8
- ◆ Parity : No
- ◆ Stop bit : 1

II. Format -NMEA0183 V2.2 :

GPGGA (1time/1 sec), GPGSA (1 time/1 sec.), GPGSV (1time /5 sec.), GPRMC (1time /1 sec.), (GLL, VTG or SiRF binary format for optional).

III. Datum : WGS84

➤ Input/ Output Interface

I. Compatible Bluetooth Serial Port Profile (SPP), Version1.1 and class 2(up to 10 meter range).

II. In/Out Port. GPS signal (Out)/Command(In) with CMOS/TTL Level.

- Mini USB Type B Connector and Cable option :
 - ◆ GAC60R2 (RS232 data cable)
 - ◆ GAC60U2 (USB data cable)
 - ◆ GAC60UP2 (Mini USB port to PS2 port).

➤ External Antenna interface

3.0V input MCX type active antenna connector

3.7. Physical

- Size : 72 x 55 x 21 mm.
- Weight : < 75 g .
- Operating Temperature : -10 °C to + 60 °C
- Storage Temperature : -20 °C to + 85 °C
- Operating humidity : 5% to 95% No condensing.

3.8. Other Functions

- Bluetooth frequency: 2.4 ~2.48GHZ
- Bluetooth Input Sensitivity: -80dbm
- Low sensitivity of receiving satellite signal : -175dBW
- LED Functions :
 - Bluetooth status
 - GPS status
 - Battery Status
 - Battery charging status

4. HARDWARE

4.1. Dimension

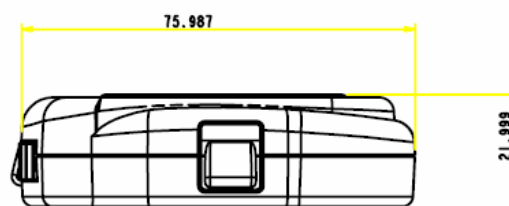
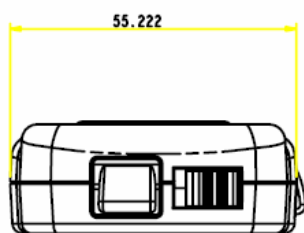
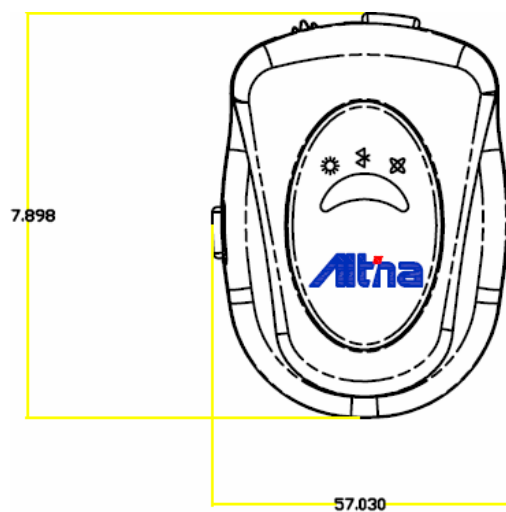

4.2. Hardware Description

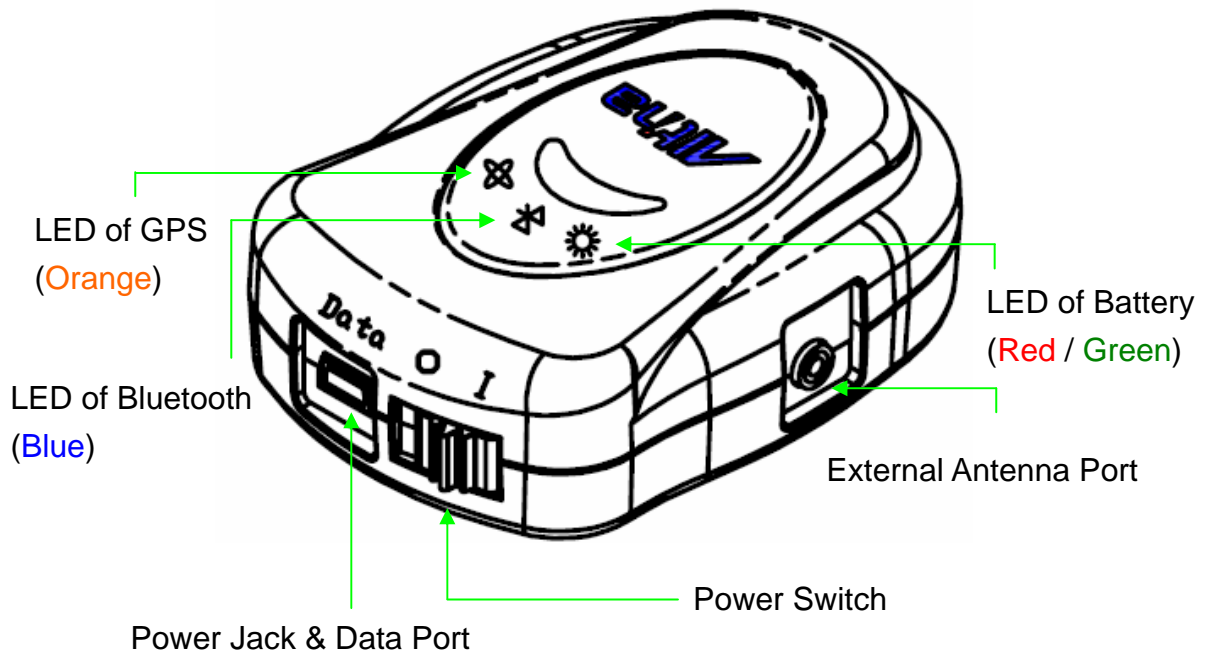

4.3. LED status

SYMBOL	COLOR	STATUS		DESCRIPTION
 Bluetooth	Blue	Blinking	3 times / 1 sec	Search Bluetooth Device
			1 time / 3 sec	Standby Mode
			1 time / 1 sec	Transferring Data
 Battery	Red	Light on		Power too low
	Green	Light on		In charging
	N/A	Light off		Battery full or Not in charging
 GPS	Orange	Light on		Acquiring Satellites
		Blinking		Position Fixed

4.4. Power Switch

- 1 : Power on
- 0 : Power off

4.5. Optional accessories, and connector description

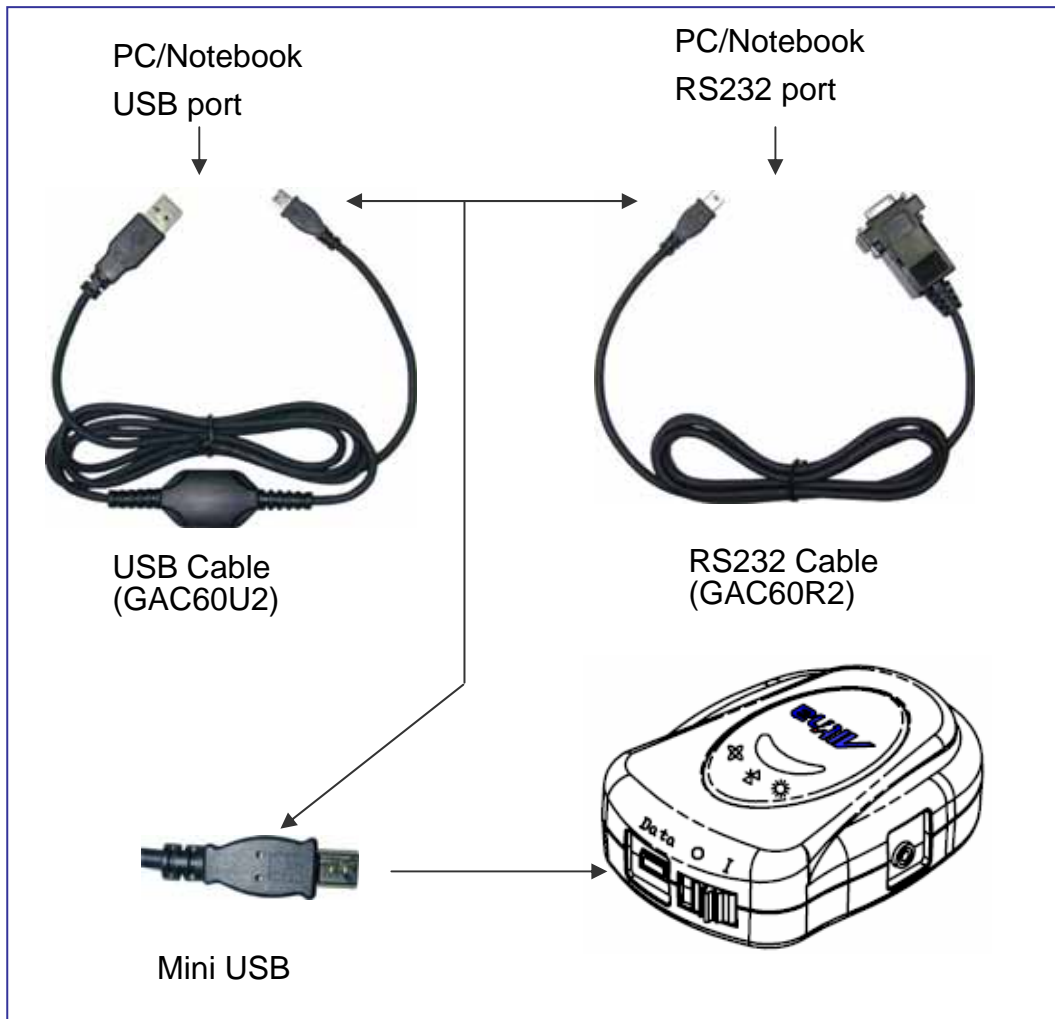

4.6. External Active Antenna connector

- Connector type: MCX, 180°
- Active power voltage: 3.0V
- Length: 5 meter

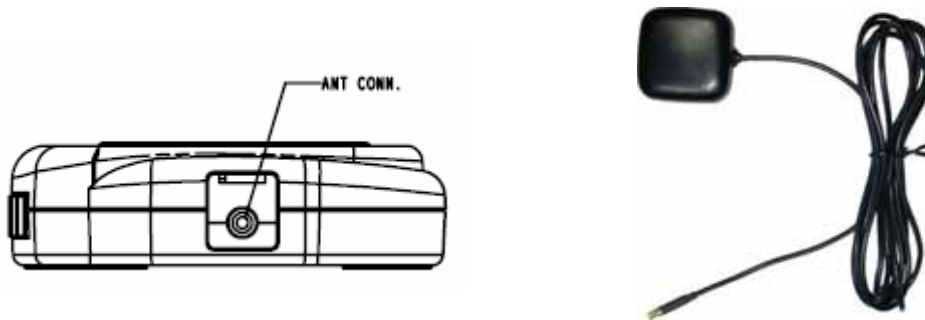

4.7. Power Jack & Data Port

- Jack type: Mating face of 5 pin Mini USB Type B female
- Pin definition please see 【Table 1】

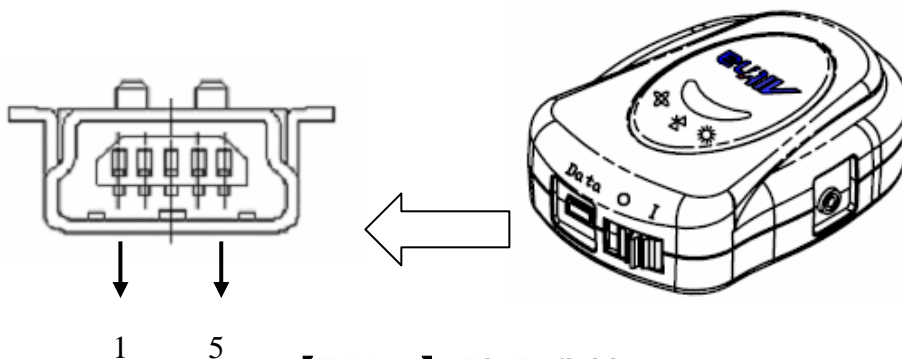

【Table 1】 : Pin Definition

Pin	Pin Name	Signal and description
1	GND	Signal ground, Battery charging ground.
2	VOUT	Unregulated voltage out: 3.6 V max 100mA.
3	TXD	Transmit Data. From organizer to peripheral.(Voltage Level is 3.3V ~ 5.0V).
4	RXD	Receive Data. Form peripheral to organizer.(Voltage level is 3.3V ~ 5.0V).
5	VCHARG	Positive terminal of DC adaptor that powers the internal charging circuit of Li-Ion battery. The approved power supply is 5.0V +/- 5%@1A.

5. SOFTWARE

5.1. Software Installation

Following steps is software installation to setup on you PDA. For some other PDA, steps may be a little different. (Bluetooth Manger is one of popular program used for Bluetooth device)

1. Click “Bluetooth Manager” on pocket pc.

[New](#)

[Connect](#)



2. Search Bluetooth device “Altina GBT708”

Select [Explore a Bluetooth device](#)

[Next](#)



3. Find Altina Bluetooth device

[Next](#)

Tap [Altina GBT-708](#)



4. Connect to SPP Slave

Select [SPP slave](#)

[Next](#)

[Finish](#)

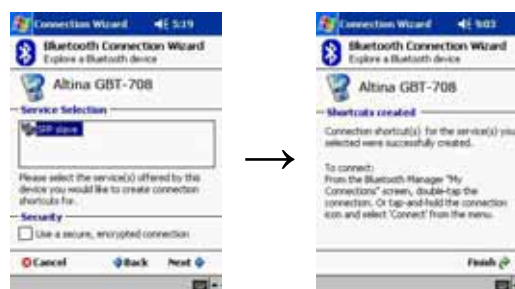

5. Connect to SPP Slave

Tap and Hold Altina GBT708: SPP slave

Connect

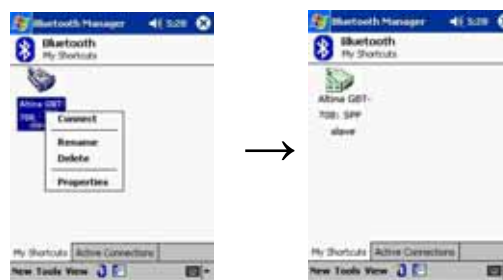

Finish Bluetooth setup (opposite arrow is displayed)

6. WARRANTY

A) Device: Altina warrants to the original end user (“Customer”) that new Altina branded products will be free from defects in workmanship and materials, under normal use, for one year if you are a purchaser in North America, Central America, and South America; 2 years if you are a purchaser in a EU member state that has enacted into national law the EU Directive on Consumer Guarantees (99/44/EC) from the original purchase date. At the time of service, the owner will need to be able to provide evidence of date and place of purchase and serial number.

B) Exclusions: This warranty excludes (1) physical damage to the surface of the product; (2) damage caused by misuse, neglect, improper installation or testing, unauthorized attempts to open, repair, or modify the product, or any other cause beyond the range of the intended use; (3) damage caused by accident, fire, power changes, other hazards, or acts of God; or (4) use of the product with any non-Altina device or service if such device or service caused the problem.

Any third party products, including software, included with Altina products are not covered by this Altina warranty and Altina makes no representations or warranties on behalf of such third parties. Any warranty on such products is from the supplier or licensor of the product.

C) Exclusive remedies: Should a covered defect occur during the warranty period and you notify Altina, your sole and exclusive remedy shall be, at Altina’s sole option and expense, to repair or replace the product. If Altina cannot reasonably repair nor replace then Altina may, in its sole discretion, refund the purchase price paid for the product. Replacement products or parts may be new or reconditioned or comparable versions of the defective item.

D) Obtaining warranty service: Dated proof of original purchase will be required. Products or parts shipped by Customer to Altina must be sent postage-paid and packaged appropriately for safe shipment. Altina is not responsible for Customer products received without a warranty service authorization and may be rejected. Repaired or replacement products become the property of Altina.

WARRANTIES EXCLUSIVE: THE FOREGOING WARRANTIES AND REMEDIES ARE



EXCLUSIVE AND IN LIEU OF ALL OTHER WARRANTIES, EXPRESS OF IMPLIED, INCLUDING WARRANTIES OF MERCHANTABILITY, FITNESS FOR A PARTICULAR PURPOSE, CORRESPONDENCE WITH DESCRIPTION, AND NON-INFRINGEMENT, ALL OF WHICH EXPRESSLY DISCLAIMED.

LIMITATION OF LIABILITY: NEITHER ALTINA NOR ITS SUPPLIERS SHALL BE LIABLE FOR INCIDENTAL, CONSEQUENTIAL, INDIRECT, SPECIAL, OR PUNITIVE DAMAGES OF ANY KIND, LOSS OF INFORMATION OR DATA, OR OTHER FINANCIAL LOSS ARISING OUT OF OR IN CONNECTION WITH THE SALE OR USE OF THIS PRODUCTS, WHETHER BASED IN CONTRACT, TORT (INCLUDING NEGLIGENCE) OR ANY OTHER THEORY, EVEN IF ALTINA HAS BEEN ADVISED OF THE POSSIBILITY OF SUCH DAMAGES. ALTINA'S ENTIRE LIABILITY SHALL BE LIMITED TO REPLACEMENT, REPAIR, OR REFUND OF THE PURCHASE PRICE PAID, AT ALTINA'S OPTION.

7. HOW TO USE

7.1. Charge Battery

Please charge battery till LED off for the first time.

Power cable plug in Power cable connect to power socket

Charge Battery

Battery indicator light:

Power too low ----- red LED

Charging ----- green LED

Full or Not in charging -- LED off

Mini USB power socket



7.2. Turn on Power

Bluetooth Status –

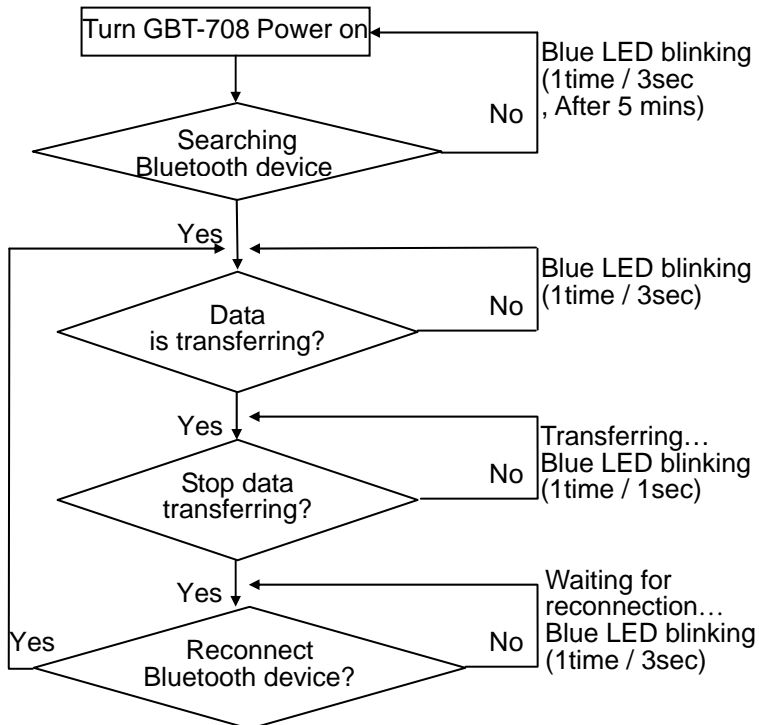

Note:
Some PDAs have to re-open Bluetooth manager for Bluetooth re-connection.

GPS Status ---

Put GBT-708 in clear view of the sky without any obstruction for better satellite acquiring.

Turn on Power of GBT-708

Search GPS ----- steady orange LED on

Position Fixed ----- orange LED blinking



8. TROUBLE SHOOTING

Problems	Reasons	Methods
No position output but timer is counting	Weak or no GPS signal can be received at the place of GBT-708	Connect an external antenna, which locate as a open space to your GBT708 and then run GPSViewer Cold start function.
	At outdoor space but GPS signal is blocked by building or car roof.	Go outdoor and run GPSViewer Cold start function to try again, or connect an external antenna to improve the poor GPS signal.
Execute fail	Bluetooth function unstable	Power On/Off GBT-708. Re-Start PDA or PC and reference sec 5.2 re-install software
Can not turn on the COM port	Install GBT-708 incompletely or operate the device is being used with same COM port	Install GBT-708 completely or stop other device that is being used.
Can not find out GBT-708	Poor connection	Re-Start PDA or PC and reference sec. 5.2 re-install software.
No Signal	No action for few minutes may cause Pocket PC entry power save mode. It will close the COM port at the same time.	Close the application and execute it again to reopen the COM port.
	Weak or no GPS signal when using GBT-708 indoor	Connect an external antenna to your GBT708.