

Care and Use Manual

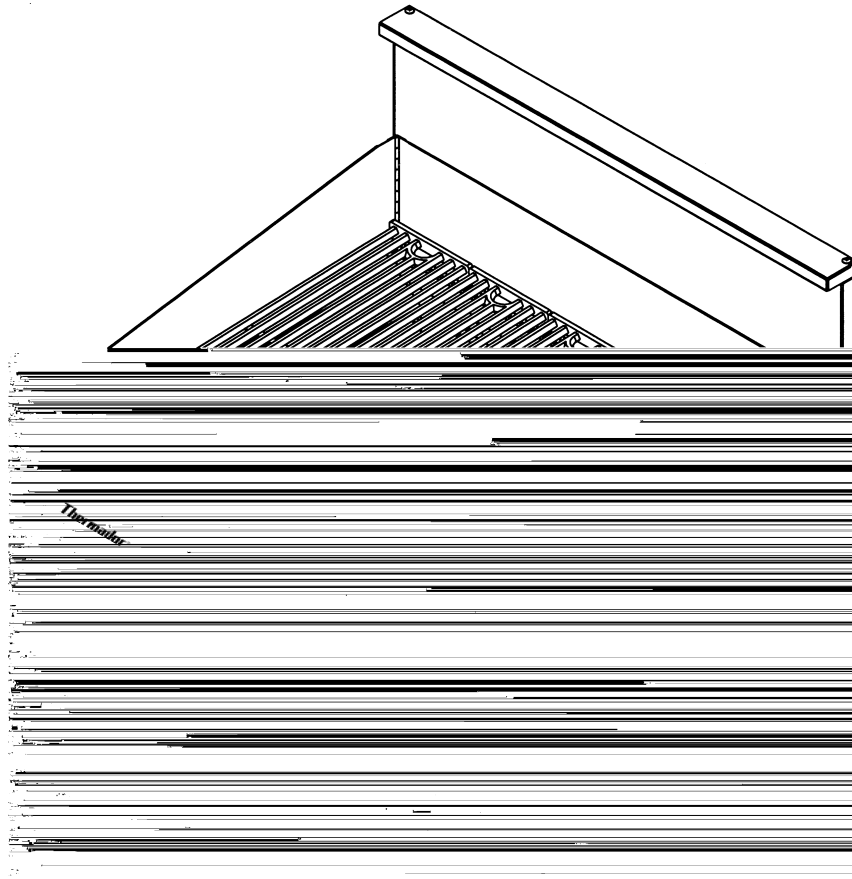

for

Thermador

PROFESSIONAL® Indoor Grill

FOR RESIDENTIAL USE ONLY

30" Model PB30YS

Thermador®

A Special Message to our Customers

Thank you for selecting the Thermador PROFESSIONAL® Indoor Grill. We recommend that you take time to read this entire booklet before using your new appliance for the first time.

The booklet contains suggestions we believe will be helpful as well as directions for using all the features of this grill. Keep it in a handy place, as it has the answers to questions that may occur when you start to grill.

Let us know if we can help you. When you write, please include the model and serial number of your grill.

Sincerely,

Thermador Test Kitchen Consumer Scientists



WARNING

If the information in this manual is not followed exactly, a fire or explosion may result causing property damage, personal injury or death.

FOR YOUR SAFETY

- ✓ **Do not store or use gasoline or other flammable vapors and liquids in the vicinity of this or any other appliance.**

AVERTISSEMENT

- ✓ **Ne pas entreposer ni utiliser de l'essence ni d'autres vapeurs ou liquides inflammables dans le voisinage de l'appareil, ni de tout autre appareil.**

WHAT TO DO IF YOU SMELL GAS

- Shut off gas to the appliance.
- Extinguish any open flame.
- Open Lid.
- If odor continues, immediately phone your gas supplier.
- If you cannot reach your gas supplier, call the fire department.

S'IL Y A UNE ODEUR DE GAZ:

- Coupez l'admission de gaz de l'appareil.
- Éteindre toute flamme nue.
- Ouvrir le couvercle.
- Si l'odeur persiste, appeler immédiatement votre compagnie de gaz ou votre département des incendies.

TABLE OF CONTENTS

Introduction 1
Gas Type Verification 1

General Safety Instructions

Safety 2
Precautions 3 – 4

Before You Begin

SAFETY PRECAUTIONS

ELECTRICAL REQUIREMENTS AND GROUNDING INSTRUCTIONS

PLEASE READ CAREFULLY

The Thermador PROFESSIONAL® Indoor Grill requires an electrical circuit rated at 120 volts, 60 Hz., 15 Amps.

For personal safety, this appliance must be connected to a properly grounded and polarized electrical power supply.

Always disconnect the electrical plug from the wall receptacle before servicing this unit.

See *Installation Instructions* for electrical requirements and grounding instructions.

DO NOT UNDER ANY CIRCUMSTANCES CUT OR REMOVE THE SEPARATE GROUND WIRE OR THE THIRD (GROUND) PRONG FROM THE POWER CORD PLUG.

It is the personal responsibility and obligation of you, the user, to have this appliance connected to the electrical power supply in accordance with the National Electrical Code and/or applicable local codes and ordinances by a qualified electrician.

It is recommended that a dedicated circuit servicing this appliance be provided.



CAUTION

In Case of an Electrical Failure

If for any reason a gas control knob is turned ON and there is no electric power to operate the electronic igniters on the grill burners, **turn OFF the gas control knob and wait 5 minutes** for the gas to dissipate before lighting the grill burner manually.

To light the grill burners manually, carefully hold a long-stem lighted match or a multi-purpose long disposable lighter to the burner ports and turn the gas control knob to HI. During a power failure, you can manually light the grill burners, but each burner must be lit with a long-stem match or a multi-purpose long disposable lighter.

See Page 7 for additional information on manually lighting the burners.

PRECAUTIONS

SAFETY PRACTICES TO AVOID PERSONAL INJURY

Your new Thermador PROFESSIONAL® Indoor Grill has been designed to be a safe, reliable appliance when properly used and cared for. If not properly used, it could be dangerous. Read all instructions in this Care and Use Manual carefully before using this Grill.

 **WARNING:** These precautions will reduce the risk of burns, electric shock, fire, and injury to persons. Use extreme care when using this restaurant caliber Grill as this appliance provides intense heat and can increase the accident potential.

- **When using kitchen appliances, these basic safety precautions must be followed:**

- **Insure proper installation and servicing.** Follow the installation instructions provided with this product. Have the Grill installed and grounded by a qualified technician.

- **Have the installer show you where the gas supply shut-off valve is located** so that you know how and where to turn off the gas to the Grill.

- **If you smell gas,** your installer has not done a proper job of checking for leaks. If the connections are not perfectly tight, you can have a small leak and therefore a faint gas smell. Finding a gas leak is not a “do-it-yourself” pro-

cedure. Some leaks can only be found with the burner control in the ON position and this must be done by a qualified service technician. See inside the front cover regarding gas leaks.

- In the event a burner goes out and **gas escapes**, open a window or a door. Do not attempt to use the Grill until the gas has had time to dissipate. **Wait at least 5 minutes before using the Grill.**

- **Do not repair or replace any part of the appliance** unless specifically recommended in this manual. All other servicing should be referred to a qualified technician.

- **Children should not be left alone or unattended in an area where appliances are in use.** They should never be allowed to sit or stand on any part of the appliance.

 **CAUTION:** Do not store items of interest to children above the Grill or at the back of it. If children should climb onto the appliance to reach these items, they could be seriously injured.

- **Never use any part of the Grill for storage.** Flammable materials can catch fire and plastic items may melt or ignite.

- If the Grill is near a window, **be certain the curtains do not blow over or near the Grill burners;** they could catch on fire.

- **DO NOT USE WATER ON GREASE FIRES.** Turn appliance off and smother fire with baking soda or use a dry chemical or foam-type extinguisher.

- **Never let clothing, pot holders, or other flammable materials come in contact with or close to any burner or burner grate** until it has cooled. Fabric may ignite and result in personal injury.

- **Use only dry pot holders.** Moist or damp pot holders on hot surfaces may cause burns from steam. Do not use a towel or other bulky cloth in place of pot holders. Do not let pot holders touch hot burner grates.

- **For personal safety, wear proper apparel.** Loose fitting garments or hanging sleeves should never be worn while using this appliance. Some synthetic fabrics are highly flammable and should not be worn while cooking.

 **Warning:** The appliance is designed for grilling food. Based on safety considerations, never use the Grill to warm or heat a room. Such use can damage the Grill.

- When using the Grill: **DO NOT TOUCH THE BURNER GRATES OR THE IMMEDIATE SURROUNDING AREAS.** They become hot enough to cause burns.

PRECAUTIONS

- **Never leave the Grill unattended.** If the burner flames are smothered, unburned gas will escape into the room. See inside the front cover regarding gas leaks.
- **Do not heat unopened food containers;** a buildup of pressure may cause the container to burst.
- Use caution to insure that drafts like those from forced air vents or fans do not blow flammable material toward the flames.
- **Do not use the Grill for grilling fatty meats or products which promote flare-ups.**
- **Do not operate the Grill without the splashguard.**
- The **grill grate covers must be removed before operating the Grill burners beneath.**
- **DO NOT USE COOKING UTENSILS** (pots, pans, etc.) **ON THE GRILL.** The appliance is intended for grilling only.
- For proper lighting and performance of the burners, **keep the ports clean.** Failure to keep port holes clean can result in nuisance sparking.
- **Clean the Grill with caution.** Avoid steam burns; do not use a wet sponge or cloth to clean the Grill while it is hot. Some cleaners produce noxious fumes if applied to a hot surface. Follow directions provided by the cleaner manufacturer.
- **Be sure all Grill controls are turned off and the Grill is cool** before using any type of aerosol cleaner on or around the Grill. The chemical that produces the spraying action could, in the presence of heat, ignite or cause metal parts to corrode.
- **Service should only be done by authorized technicians.** Technicians must disconnect the power supply before servicing this unit.
- **Clean the ventilator hood and filters above the Grill frequently** so grease from grilling vapors does not accumulate on them.
- **Turn the hood OFF in case of fire.**
- **Turn the hood ventilator ON when intentionally “flaming” liquor or other spirits on the Grill.**
- **Install a smoke detector** in or near the kitchen.
- If a burner goes out and **gas escapes**, turn the control knob off. Open a window or door. Do not attempt to use the Grill until the gas has had time to dissipate.
- **California Proposition 65 Warning:** The burning of gas grilling fuel generates some by-products which are on the list of substances which are known by the State of California to cause cancer or reproductive harm. California law requires businesses to warn customers of potential exposure to such substances. To minimize exposure to these substances, always operate this unit according to the instructions contained in this booklet and provide good ventilation to the room when grilling with gas.

SAVE THESE INSTRUCTIONS

MODEL and PARTS IDENTIFICATION

Key for Model PB30RYS

I

USING YOUR INDOOR GRILL

Before the First Use

1. Burn off residual manufacturing oils. Follow Burner Lighting Instructions (Page 7) and then:
 - ✓ Turn all burners on HI setting for 15 - 20 minutes.
 - ✓ Cool.
2. Prepare for use.
 - ✓ Optional step: Line drip tray with heavy-duty aluminum foil and a thin layer of sand or bird gravel.
 - ✓ Protect the finish with a stainless steel cleaner or protective polish. See care suggestions Page 10.



If you smell gas, do not attempt to light any burners.

1. Make sure that all control knobs are turned to the OFF position.
2. Open the window to allow any accumulated gas to dissipate and wait five minutes before trying to light the unit.
3. If the smell of gas is still present, turn off the gas supply to the unit at the manual shut off valve.
4. Check the unit for leaks by following the instructions in Section 6 in the Installation Instructions or call your authorized servicer or the gas company.

GENERAL INFORMATION

1. Estimate the grilling time and heat settings according to the suggestions on the Grilling Chart, Pages 8 – 9.
2. For manual lighting due to power failure, follow directions, Page 7.
3. Preheat the grill about 10 minutes.

FOR BEST RESULTS

- Thaw food items before grilling.
- Preheating provides the high heat needed to brown and seal in juices.
- After preheating, reduce the flame to setting listed on Grilling Chart.
- The degree of doneness is influenced by the type of meat, cut of meat (i.e. size, shape and thickness), heat setting selected, and length of time on the grill.
- Shorten the preheat time when grilling high-fat cuts of meat or poultry, such as chicken thighs. This will help reduce flare-ups.
- Cuts of meat with high fat content should not be grilled.
- Lightly oil grill when cooking low-fat cuts of meat, fish or poultry, such as lean hamburger patties, shrimp or skinless chicken breasts.
- For best results food should be turned only once.
- Avoid puncturing or cutting the meats to test doneness. This will allow juices to escape.
- When using a high flame, add barbecue sauce to food during the last 10 minutes before removing from grill.

USING YOUR INDOOR GRILL

EXCESSIVE FLAMING OR FLARE UPS

This Professional Indoor Grill is equipped with two 20,000 BTU/HR U-shaped burners to provide the high heat and uniform temperature distribution required for quality grilling. The intense heat, however, may result in flareups due to drippings of grease and fat. This is a normal part of the cooking process. It is imperative that the grilling process be supervised at all times, so that the user can oversee this active cooking method.

Should the flame become excessive, remove the food from the grill and turn the control knob to OFF. Use baking soda to extinguish the flames. Excessive flaming may occur when cooking meat with a lot of fat (i.e., 30% ground beef, steaks with a heavy fat layer around the edge, lamb chops, etc.

Use caution when turning any kind of meat. The melted fat dropping onto the stainless radiant may create a flare-up. If a flare-up occurs, use a long handled spatula to move food to another area until the flames subside.

GRILLING HINTS

- ◆ **DO NOT** leave the grill unattended while cooking.
- ◆ The doneness of meat, whether rare, medium or well done, is affected to a large degree by the thickness of the cut. Expert chefs say it is impossible to have a rare doneness with a thin cut of meat.
- ◆ The cooking time is affected by the kind of meat, the size and shape of the cut, the temperature of the meat when cooking begins and the degree of doneness desired.
- ◆ Use a spatula instead of tongs or a fork to turn the meat, as a spatula will not puncture the meat and let the juices run out.
- ◆ To get the juiciest meats, add seasoning or salt after the cooking is finished and turn the meat only once (juices are lost when the meat is turned several times). Turn the meat just after the juices begin to bubble to the surface.
- ◆ Trim any excess fat from the meat before cooking. To prevent steaks or chops from curling during cooking, slit the fat around the edges at 2-inch (51 mm) intervals.
- ◆ To test for doneness, make a small slash in the center of the meat, not at the edge. This prevents loss of juices.
- ◆ To prepare rarer meats or maintain warmth, place the food at the front section of the grill.

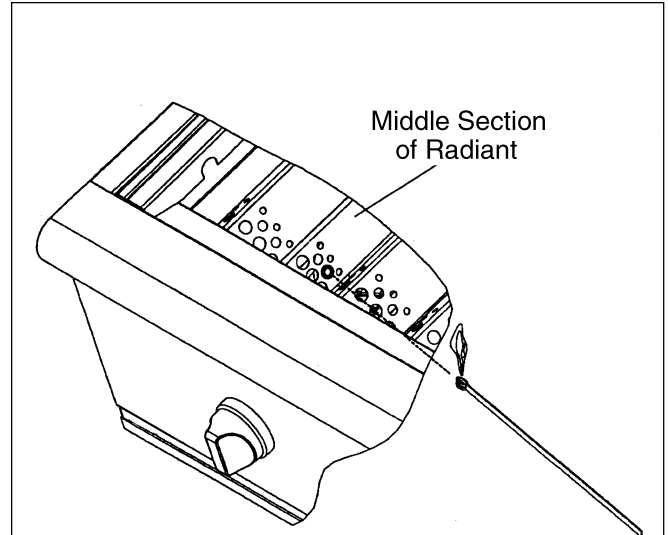

Access hole for manual lighting

LIGHTING INSTRUCTIONS

for Manual Lighting

– Read Before Lighting –

Follow these steps to light the grill burners manually:

1. Turn off all the burners.
2. Wait 5 minutes to allow any accumulated gas to dissipate.

Use a long stem match or a multipurpose long disposable lighter to light manually:

3. Remove the grill grates.
4. Find the ports on top of the burner by looking through the opening at the end of the radiant. Keep your hands and face as far away from the burner as possible.
5. Place the lighted long-stem match or lighter through the hole in the radiant. This positions it near the burner ports.
6. Turn the knob to the LITE position. The burner will light within 4 to 10 seconds.

Grilling Chart

MEASURING HEAT SETTINGS:

Knobs have **HIGH** and **LOW** setting for flame adjustment.

Heat settings indicated below are approximate.

For best results, keep hood fan speed on low.

FOOD ITEM	THICKNESS/ WEIGHT	BURNER SETTING	INTERNAL DONENESS OR TEMPERATURE (°F)	APPROXIMATE GRILLING TIME
BEEF				
Ground Beef Patties	4 oz./1/2" thick	Medium	No pink color	10-15 minutes
Roast, Tri Tip	2" thick	Med. Hi	140° F Rare 145° F Medium Rare	50-60 minutes
Steaks				
Ribeye	1" thick	Hi	140° F Rare 145° F Medium Rare	12-15 minutes 15-18 minutes
Ribeye	1-1/2" thick	Hi	140° F Rare 145° F Medium Rare	20-25 minutes 25-30 minutes
New York Strip	1" thick	Hi	140° F Rare 145° F Medium Rare	20-24 minutes 24-27 minutes
New York Strip	1-1/2" thick	Hi	140° F Rare 145° F Medium Rare	27-30 minutes 30-33 minutes
T-Bone	1" thick	Hi	140° F Rare 145° F Medium Rare	18-20 minutes 20-22 minutes
T-Bone	1-1/2" thick	Hi	140° F Rare 145° F Medium Rare	30-33 minutes 33-35 minutes
Tenderloin	1-1/2" thick	Hi	140° F Rare 145° F Medium Rare	18-25 minutes
Flank	1/2 to 1" thick	Hi	140° F Rare 145° F Medium Rare	20-25 minutes
PORK				
Boneless Chops	1" thick	Hi	160° Well Done	25-28 minutes
Rib Chops	1-1/2" thick	Hi	160° Well Done	25-30 minutes
Whole Tenderloin	1 lb.	Hi	160° Well Done	28-35 minutes
Spareribs	4 lb.	Low	Well Done	2-1/2 - 3 hours
Baby Back Ribs	2 lbs.	Low	Well Done	2-1/2 - 3 hours
Ham Slice	1" thick	Hi	160° Well Done	20-25 minutes
Smoked Kielbasa	1" diameter	Hi	160° Well Done	17-19 minutes
Fresh Bratwurst	1" diameter	Hi	160° Well Done	23-25 minutes

Grilling Chart

FOOD ITEM	THICKNESS/ WEIGHT	BURNER SETTING	INTERNAL DONENESS OR TEMPERATURE (°F)	APPROXIMATE GRILLING TIME
POULTRY				
Chicken				
Boneless Breasts	4-6 oz.	Hi	160° or until the juices run clear	15-20 minutes
Bone-in Pieces	2-1/2" - 3-1/2" lbs.	Medium	160° in breast 170° in thigh	20-45 minutes depending upon size of piece
Halves	1-1/2" - 2 lbs. each half	Medium Low	160° in breast 170° in thigh	1-1/4 to 1-1/2 hour
Cornish Game Hens				
Halves	1/2" lbs. each half	Medium	160° in breast 170° in thigh	30 to 45 minutes
Turkey:				
Boneless Breast	2" thick	Med Hi	160°	50-60 minutes
Tenderloins	1/2" lbs. each	Medium	160°	35-40 minutes
LAMB				
Chops				
Loin	1" thick	Hi	145° Medium Rare 150° Medium	8-10 minutes 10-12 minutes
FISH				
Filletts	1/2" to 1" thick	Hi	Flakes with a fork	6-7 minutes per each 1/2" of thickness
Whole	7-10 oz.	Hi	Flakes with a fork	15-20 minutes
SHELLFISH				
Scallops	Large	Medium	Opaque	15-18 minutes
Shrimp	Medium	Medium	Opaque	5-8 minutes
Lobster Tails	Medium	Hi	Opaque	20-25 minutes
FRUIT				
Fresh Pineapple	Quarters	Medium Hi	150° F. Soft and Warm	20-30 minutes
Fresh Pineapple	Kabobs	Medium Hi	150° F. Soft and Warm	15-20 minutes
VEGETABLES				
Asparagus	Spears	Medium Hi	Slightly Limp	5-10 minutes
Bell Peppers	Halves	Medium Hi	Soft	15-20 minutes
Tomatoes	Large Slices	Medium Hi	Warm	5-7 minutes
Yellow Squash	1/2" slices	Medium Hi	Soft	15-20 minutes
Zucchini	1/2" slices	Medium Hi	Soft	15-20 minutes

CLEANING THE INDOOR GRILL

GRILL CAUTIONS:

1. When disassembling or reassembling the Grill, use extreme caution to avoid contact with the fragile ceramic igniter. The igniters may break, preventing operation of the grill.
2. To reduce flare ups during grilling, operate the grill for 15 minutes after cooking is complete to burn off excess grease.

Brand Names

The use of brand names is intended only to indicate a type of cleaner. This does not constitute an endorsement. The omission of any brand name cleaner does not imply its adequacy or inadequacy. Many products are regional in distribution and can be found in the local markets. Strictly follow instructions for use.

DO NOT CLEAN ANY REMOVABLE PARTS OF THE GRILL IN A SELF-CLEANING OVEN.

CLEANING CHART

PART and MATERIAL	SUGGESTED CARE
Exterior Finish - Stainless Steel	<u>Stainless Steel Finish Protector:</u> Stainless Steel Magic® and EZ Brite®. The quality of this material resists most stains and pitting, providing the surface is kept clean and protected. Apply to a clean surface. <u>Nonabrasive Cleaners:</u> detergent and water, Fantastik®, 409®, vinegar. <u>Mild abrasive Cleaners:</u> liquid Kleen King®,
Drip Tray – Stainless Steel	Tip: Keep a thin layer of sand or bird gravel on top of foil liner to absorb grease. Cool indoor grill. Remove tray and set on a flat surface. Remove foil liner. Wipe up excess grease with paper towels. Wash with detergent and hot water or multi-purpose cleaner, i.e. 409® or Fantastik®. Rinse and dry; reline with heavy-duty foil. Replace tray. Clean often to avoid possibility of a grease fire.
Knobs Plastic	Wash with detergent and warm water; rinse and dry.
Reflectors, Burner Box – Stainless Steel	Discoloration of stainless steel on these parts is to be expected, due to the intense heat from the burners. Use a spatula to scrape food particles and residual grease into the drip tray. Wipe out with cloth or sponge as necessary.
Grates/Grill – Porcelain on iron	Refer to the Quick Clean Method. Grates may also be scrubbed with an SOS® pad and hot water when cool.
Double-U™ shape Grill Burner Aluminized Steel	Cool indoor grill. Remove grates and radiant baffles. Lift grill burner from the rear and remove. Clean the exterior of the grill burner with a plastic dishwashing pad. Use a straightened paper clip to clear clogged ports. Shake out any debris through the air shutter. (Do not use a wooden toothpick to clear any debris in the clogged ports.)

Quick Clean Method for Grates

1. Immediately after cooking, turn off the burners. Fill a container with very hot water.
2. Using a long handled, brass barbecue brush dipped in hot water, scrub the hot grates. Use a heavy mitt to protect your hand from the heat and steam.
3. Repeat. Scrub each grate with the wire brush to remove cooked on food soil. The steam created from applying water to the hot grate softens the soil, making it easier to remove.
4. Charred particles will fall into the drip tray below. Wipe out particles; replace aluminum foil liner.

Quick Clean Method for the Drip Tray

Check tray after each use.

1. Line tray with heavy foil.
2. Spread thin layer of sand or bird gravel over foil to absorb grease.
3. When time to replace foil liner and sand, pull corners of foil to center, bundle and throw away.

Cleaning the Overhead Hood

Caution: Keep the exhaust hood free of grease build-up. It is recommended that the grease collection tray and the baffles be removed and cleaned after each use when grilling large amounts of meats, or meats with high fat content. Clean the interior surfaces of the hood frequently.

DO-IT-YOURSELF MAINTENANCE

INTERMITTENT OR CONSTANT IGNITER SPARKING

Intermittent or constant sparking of the grill burners can result from a number of preventable conditions. Eliminate these conditions as indicated in the chart.

SYMPTOM	CAUSE	REMEDY
Intermittent sparking	<ul style="list-style-type: none"> • Burner ports are clogged. 	<ul style="list-style-type: none"> • Clean ports in burner with a wire, a needle or straightened paper clip.
Constant Sparking	<ul style="list-style-type: none"> • Indoor Grill is not properly grounded • Electrical power supply incorrectly polarized. 	<ul style="list-style-type: none"> • Refer to Installation Instructions. • Refer to Installation Instructions. • Have a qualified electrician ground the grill properly for correct installation.

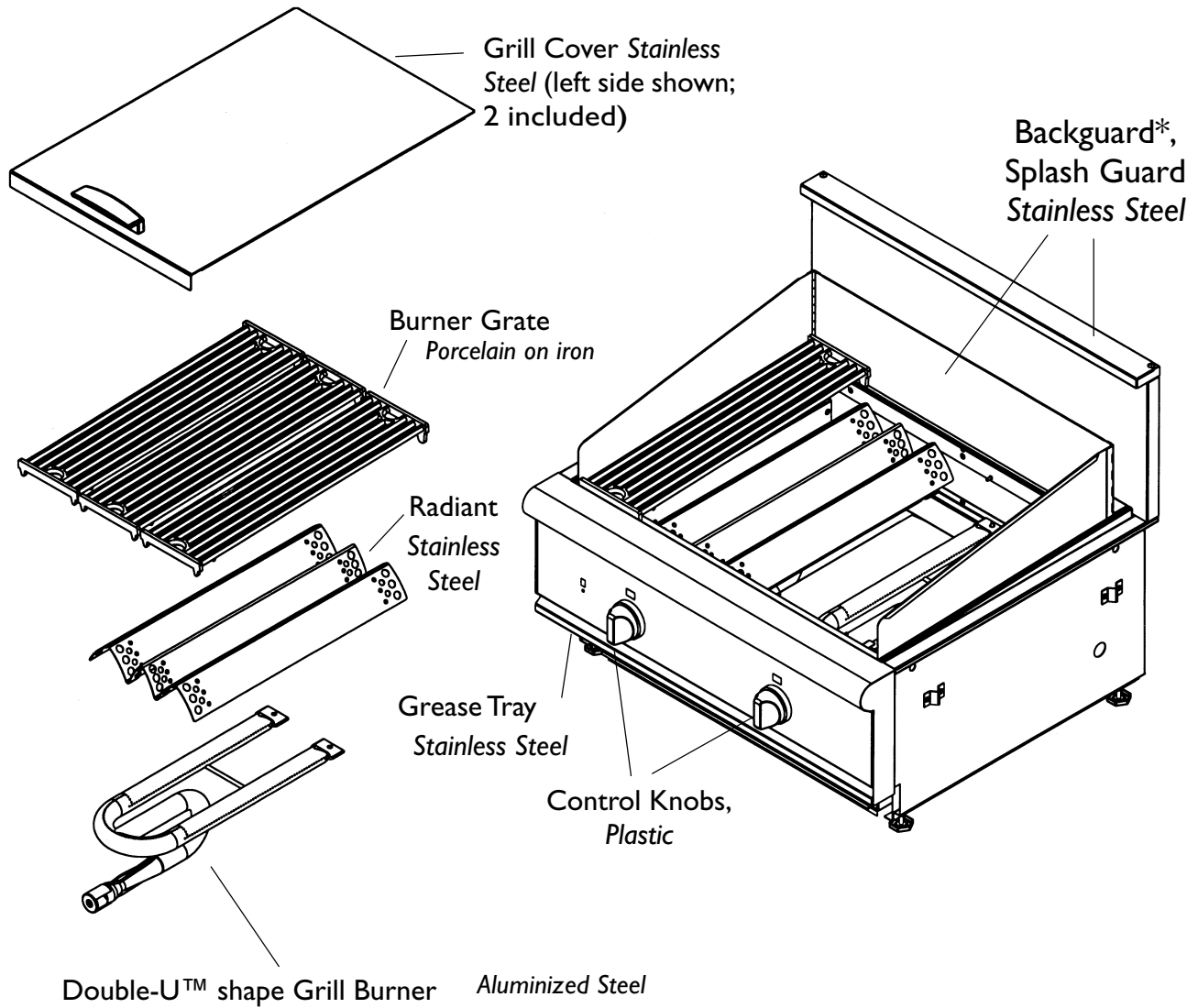

BEFORE CALLING FOR SERVICE

Before calling for service, check the following to avoid unnecessary service charges.

Be sure to check these items first:

- Is there a power outage in the area?
- Is the household fuse blown or the circuit breaker tripped?
- Is the grill disconnected from the electrical supply?

IF THE BURNERS DO NOT IGNITE

- Are the burner ports clogged?
- Is a fuse blown or is the circuit breaker tripped?
- Is the manual shut-off valve closed, preventing the flow of gas?
- Is the spark igniter sparking?

DATA RATING PLATE

Indoor Grill:

The data rating plate shows the model and serial numbers of your Indoor Grill. It is located on the underside of the Grill chassis near the gas inlet connection and electric power cord.

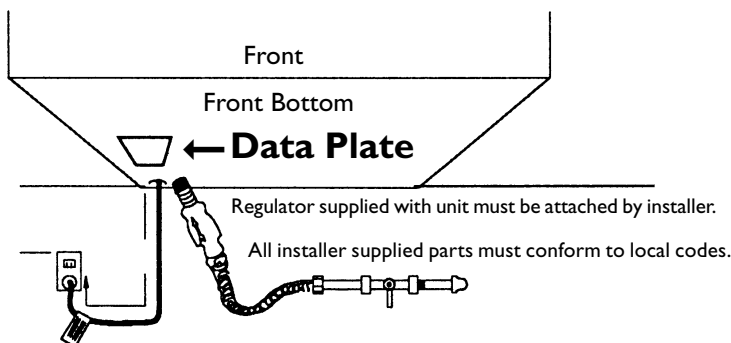

CUSTOMER SERVICE:

800/735-4328

or see our website:
www.thermador.com

SERVICE INFORMATION

Serial Number

Date of Purchase

Dealer's Name

Dealer's Phone Number

Service Center's Name

Service Center's Phone Number

Also, enter this information on the Product Registration Form included with this product, then mail it to the indicated address.

— Thank You.

WARRANTY

FULL ONE YEAR WARRANTY

Covers one year from the date of installation or date of occupancy for a new previously unoccupied dwelling. Save your dated receipt or other evidence of the installation/occupancy date.

Thermador® Will Pay For:

All repair labor and replacement parts found to be defective due to materials and workmanship.

Service must be provided by a Factory Authorized Service Agency during normal working hours.

For a Service Agency nearest you, please dial 800/735-4328.

Thermador® Will Not Pay For:

1. Service by an unauthorized agency. Damage or repairs due to service by an unauthorized agency or use of unauthorized parts.
2. Service visits to:
 - Teach you how to use the appliance.
 - Correct the installation. You are responsible for providing electrical wiring and other connecting facilities.
 - Reset circuit breakers or replace home fuses.
3. Damage caused from accident, alteration, misuse, abuse, improper installation or installation not in accordance with local electrical codes or plumbing codes, or improper storage of the appliance.
4. Repairs due to other than normal home use.
5. Service labor during limited warranty period.
6. Travel fees and associated charges incurred when the product is installed in a location with limited or restricted access (i.e., airplane flights, ferry charges, isolated geographic regions).

Warranty applies to appliances used in residential application: it does not cover their use in commercial installations.

This warranty is for products purchased and retained in the 50 states of the U.S.A., the District of Columbia and Canada. Should the appliance be sold by the original purchaser during the warranty period, the new owner continues to be protected until the expiration date of the original purchaser's warranty period.

The warranty applies even if you should move. **Thermador does not assume any responsibility for incidental or consequential damages.** Some states do not allow the exclusion or limitation of incidental or consequential damages, so the above limitation or exclusion may not apply to you. This warranty gives you specific legal rights and you may also have other rights which may vary from state to state or province to province.

Specifications are for planning purposes only. Refer to installation instructions and consult your countertop supplier prior to making counter opening. Consult with a heating and ventilating engineer for your specific ventilation requirements. For the most detailed information, refer to installation instructions accompanying product or write Thermador indicating the model number.

Thermador reserves the right to change specifications or design without notice. Some models are certified for use in Canada. Thermador is not responsible for products which are transported from the United States for use in Canada. Check with your local Canadian distributor or dealer. Thermador, 555 I McFadden Avenue, Huntington Beach, CA 92649.

For the most up to date critical installation dimensions by fax, use your fax handset and dial 702/833-3600. Use code #8030.

Thermador[®]

555 I McFadden Avenue, Huntington Beach, CA 92649 • 800/735-4328
ECO16098 • 08-04-754B • © BSH Home Appliances Corp. 2000 • Litho U. S. A. 3/01