

Aussie[®] by Meco[®]



ULURU[™] LP Gas Grill *Elite* Assembly and Use Manual



MODELS: 8452-5-SS1 Liquid Propane
8452-5-SL1 Liquid Propane



MODEL 8452-5-S11 Liquid Propane

FOR OUTDOOR HOUSEHOLD USE ONLY. NOT FOR COMMERCIAL USE.

For Customer Service, call 1-800-251-7558 or visit our web site at www.meco.net

WARNING

- Failure to follow these instructions could result in fire or explosion which could cause death, serious personal injury, or property damage.
- Read and follow instructions carefully before assembly or use.
- **Do not use** this product for any other purpose than which it is intended.
- These instructions must be kept with the user. **SAVE THESE INSTRUCTIONS.**

DANGER

If you smell gas:

1. Shut off gas to the appliance.
2. Extinguish any open flame.
3. Open lid.
4. If odor continues, keep away from the appliance and immediately call your gas supplier or your fire department.

WARNING

1. Do not store or use gasoline or other flammable vapors and liquids in the vicinity of this or any other appliance.
2. An LP cylinder not connected for use shall not be stored in the vicinity of this or any other appliance.

CONTENTS

| | |
|--|--|
| <p>I. ASSEMBLY INSTRUCTIONS.....2</p> <p> A) Parts Illustrations.....3</p> <p> B) Parts List.....4</p> <p> Step 1) Cylinder Clamp/Back Panel Assembly.....5</p> <p> Step 2) Cart Sides and Bottom Assembly.....6</p> <p> Step 3) Front Crossbar Assembly.....6</p> <p> Step 4) Caster Cart Assembly.....7</p> <p> Step 5) Door Assembly.....7</p> <p> Step 6) Hood/Bowl to Cart Assembly.....8</p> <p> Step 7) Burner Side Table Assembly.....9</p> <p> Step 8) Side Burner Valve Assembly.....9</p> <p> Step 9) Side Burner Assembly.....10</p> <p> Step 10) Side Burner Knob/Grid Assembly.....10</p> <p> Step 11) Burner Removal/Re-Assembly.....11</p> <p> Step 12) Foil Pan/Grease Pan/Drip Assembly..... 11</p> <p> Step 13) Flame Diffuser/Cooking Grid/Warming Rack Assembly.....12</p> <p> Step 14) Wiring the Ignition Box.....12</p> <p> Step 15) Install the Ignition Box.....12</p> <p>II. Connect/Disconnect Gas to the Grill.....13</p> <p> A) Using Gas.....13</p> <p> B) LP Gas Cylinder.....13</p> <p> C) LP Hose & Regulator.....13</p> | <p> 1) Connecting LP Gas Cylinder.....14</p> <p> 2) Dis-connecting LP Gas Cylinder.....14</p> <p>III. Operating and Maintaining Your LP Gas Grill,.....14</p> <p> A) Before Using Your Grill.....14</p> <p> B) Installation Codes.....14</p> <p> C) Selecting a Location.....14</p> <p> D) Performing a Leak Test.....14</p> <p> E) Lighting Using Pulse Spark Ignition.....16</p> <p> F) Manual Lighting of the Grill.....17</p> <p> G) Lighting the Side Burner.....17</p> <p> H) Check your Flame.....17</p> <p> I) Manual Lighting the Side Burner.....18</p> <p>IV. Grill Cooking.....18</p> <p> A) Warming Rack.....18</p> <p> B) Roasting Hood Cooking.....18</p> <p> C) Operating the Gas Grill.....18</p> <p> D) End of Cooking Session.....19</p> <p>V. Care and Maintenance.....19</p> <p> A) Cleaning the Grill.....19</p> <p> B) Storage.....21</p> <p>VI. Troubleshooting.....21</p> <p>VII. Important Notice-LP Cylinder with OPD.....23</p> <p>VII. Limited Warranty.....24</p> |
|--|--|

— NOTICE —

MECO CORPORATION STRIVES TO BE A QUALITY SUPPLIER OF CONSUMER PRODUCTS. IF WE OMITTED ANY PARTS NEEDED FOR ASSEMBLY, OR YOU NEED TROUBLESHOOTING INFORMATION, PLEASE CONTACT US USING OUR TOLL FREE NUMBER. THANK YOU FOR PURCHASING A MECO CORPORATION PRODUCT.

1-(800)-251-7558
 8 am - 6 pm E.S.T Mon. - Fri.
 1-(423)-639-1171 (TELEPHONE)
 1-(423)-639-2570 (FAX)

CONSUMER SERVICE DEPARTMENT
 MECO CORPORATION
 1500 INDUSTRIAL ROAD
 GREENEVILLE, TN. 37745 USA

www.meco.net

! DANGER

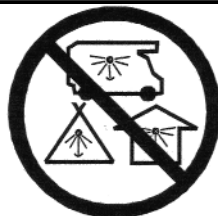

CARBON MONOXIDE HAZARD

This appliance can produce carbon monoxide which has no odor.

Using it in an enclosed space can kill you.

Never use this appliance in an enclosed space, such as a camper, tent, car or home.

ASSEMBLY INSTRUCTIONS

! WARNING

To reduce the risk of serious bodily injury or death:

- The use of alcohol, prescription or non-prescription drugs could impair the consumer's ability to properly assemble or safely operate this appliance.
- Do not connect LP cylinders until assembly is complete.

PREPARATION FOR ASSEMBLY: Remove Grill and all the packaging from carton and place on floor. Make sure there are no loose parts. **Note: Before using your grill, read the instructions and your manual.** For easier set-up and assembly, follow instructions of each step in the order they are written as you look at the diagrams. If accessories mentioned in certain assembly steps do not come with your model, skip that step and proceed to the next step that applies to your model.

If you need replacement parts, look in the Parts List Section to find the exact parts you need. If you have any questions or need help, contact our Customer Service. Be sure to mention the grill model number located on right side of the grill body.

PARTS ILLUSTRATIONS

If you need replacement parts, refer to the Parts Illustrations and the Parts List to find the exact parts you need. If you have any questions which require help, contact Customer Service and be sure to mention the model number of your grill.



(1) OWNERS MANUAL



(2) SILVER BACK PANEL

(3) BLACK BACK PANEL

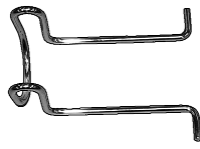

(4) LP CYLINDER CLAMP

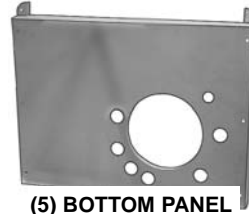

(5) BOTTOM PANEL SILVER

(6) BOTTOM PANEL BLACK



(7) M6 x 15 SCREW



(8) M6 NUT



(17) M6 x 20 SCREW

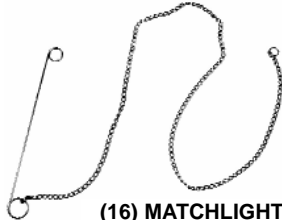

(16) MATCHLIGHT HOLDER & CHAIN



(14) LEFT SIDE PANEL SILVER

(15) LEFT SIDE PANEL BLACK



(13) ST4.0 x 10MM SCREW

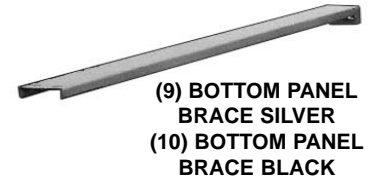

(9) BOTTOM PANEL BRACE SILVER
(10) BOTTOM PANEL BRACE BLACK



(18) M6 SLEEVE



(19) RIGHT SIDE PANEL SILVER

(20) RIGHT SIDE PANEL BLACK



(21) FRONT CROSSBAR SILVER

(22) FRONT CROSSBAR BLACK



(23) FIXED CASTER

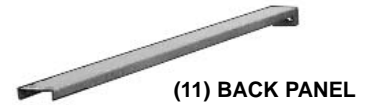

(11) BACK PANEL BRACE SILVER
(12) BACK PANEL BRACE BLACK



(24) SWIVEL CASTER



(30) HOOD/BOWL ASSEMBLY
(SEE 31 & 32 or 33 FOR REPLACEMENT)



(28) RIGHT DOOR 430 SS

(29) RIGHT DOOR BLACK

(64) RIGHT DOOR SILVER



(26) LEFT DOOR 430 SS

(27) LEFT DOOR BLACK

(63) LEFT DOOR SILVER

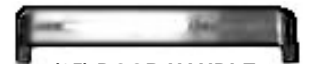

(25) DOOR HANDLE

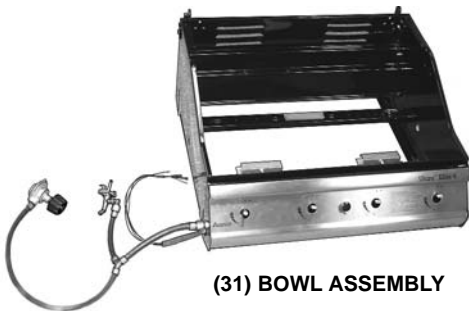

(31) BOWL ASSEMBLY



(32) HOOD ASSEMBLY 430/SILVER

(33) HOOD ASSEMBLY 430/BLACK



(34) HOOD SPRING CLIP



(35) HOOD PIN



(36) LEFT SIDE BURNER TABLE SILVER

(37) LEFT SIDE BURNER TABLE BLACK



(45) M4 X 8MM SCREW

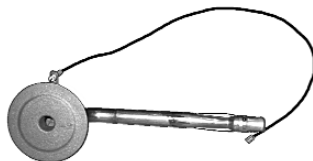

(44) SIDE BURNER



(42) M5 X 10MM SCREW



(43) M5 HEX NUT



(41) SIDE BURNER VALVE

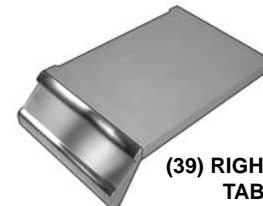

(39) RIGHT SIDE BURNER TABLE SILVER

(40) RIGHT SIDE BURNER TABLE BLACK



(38) M4 X 15MM SCREW



(46) SIDE BURNER ELECTRODE



(47) CONTROL KNOB



(48) SIDE BURNER GRID



(49) MAIN BURNER



(50) MAIN BURNER PIN

PARTS ILLUSTRATIONS (Cont'd)



(51) FOIL PAN



(52) GREASE PAN

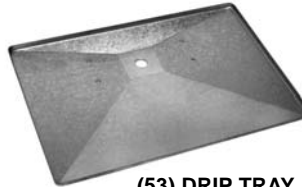

(53) DRIP TRAY



(54) FLAME DIFFUSER

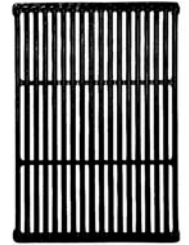

(55) COOKING GRID



(60) HEAT INDICATOR



(59) LP HOSE AND REGULATOR



(58) IGNITION BOX SHIM



(57) IGNITION BOX



(56) WARMING RACK



(61) IGNITOR SWITCH



(62) ELECTRODE MAIN BURNER



(63) MANIFOLD ASSEMBLY (LP)

| PARTS LIST | | | |
|------------|--|-----------------|------|
| ITEM | DESCRIPTION | PART # | QTY. |
| 1 | Owner's Manual | 03.6538.00 | 1 |
| 2 | Back Panel-Silver | 03.6508.00 | 1 |
| 3 | Back Panel-Black | 03.6508.01 | 1 |
| 4 | LP Cylinder Clamp | 03.6510.00 | 1 |
| 5 | Bottom Panel-Silver | 03.6511.00 | 1 |
| 6 | Bottom Panel-Black | 03.6511.01 | 1 |
| 7 | Screw, M6 x 15 | 03.6385.00 | 55 |
| 8 | Nut, M6 | 03.6470.00 | 15 |
| 9 | Brace, Bottom Panel Silver | 03.6513.00 | 1 |
| 10 | Brace, Bottom Panel Black | 03.6513.01 | 1 |
| 11 | Brace, Back Panel Silver | 03.6514.00 | 1 |
| 12 | Brace, Back Panel Black | 03.6514.01 | 1 |
| 13 | Screw, ST4.0 x 10mm | 03.6223.00 | 9 |
| 14 | Left Side Panel Silver | 03.6515.00 | 1 |
| 15 | Left Side Panel Black | 03.6515.01 | 1 |
| 16 | Match Light Holder & Chain | 03.6516.00 | 1 |
| 17 | Screw, M6 x 20 | 03.6517.00 | 1 |
| 18 | Sleeve, M6 x20 Bolt (Match Light Hanger) | 03.6518.00 | 1 |
| 19 | Right Side Panel Silver | 03.6519.00 | 1 |
| 20 | Right Side Panel Black | 03.6519.01 | 1 |
| 21 | Crossbar, Front Silver | 03.6520.00 | 1 |
| 22 | Crossbar, Front Black | 03.6520.01 | 1 |
| 23 | Caster, Fixed | 03.6521.00 | 2 |
| 24 | Caster, Locking Swivel | 03.6522.00 | 2 |
| 25 | Door Handle | 03.6413.00 | 2 |
| 26 | Left Door 430 SS | 03.6443.00 | 1 |
| 27 | Left Door Black | 03.6443.01 | 1 |
| 28 | Right Door 430 SS | 03.6444.00 | 1 |
| 29 | Right Door Black | 03.6444.01 | 1 |
| 30 | Grill Body Assembly 430 SS/Black | (See 31, 32/33) | 1 |

| PARTS LIST (Cont'd) | | | |
|---------------------|--|----------------|---|
| 31 | Bowl Assembly SS/Black | 03.6523.00 | 1 |
| 32 | Hood Assembly 430 SS/Silver | 03.6524.00 | 1 |
| 33 | Hood Assembly 430 SS/Black | 03.6524.01 | 1 |
| 34 | Spring Pin, Hood Hinge | 03.6525.00 | 2 |
| 35 | Clevis Pin, Hood Hinge | 03.6526.00 | 2 |
| 36 | Side Table, Left Burner SS/Silver | 03.6527.00 | 1 |
| 37 | Side Table, Left Burner SS/Black | 03.6527.01 | 1 |
| 38 | Screw, M4x15mm (Side Table Front) | 03.6528.00 | 4 |
| 39 | Side Table, Right SS/Silver | 03.6529.00 | 1 |
| 40 | Side Table, Right SS/Black | 03.6529.01 | 1 |
| 41 | Valve, Side Burner | 03.6530.00 | 1 |
| 42 | Screw, M5x10mm (Side Burner Valve Bracket) | 03.6531.00 | 2 |
| 43 | Nut, M5 Hex | 03.6532.00 | 2 |
| 44 | Side Burner & Venturi | 03.6533.00 | 1 |
| 45 | Screw, M4x8mm (Side Burner & Door Handle) | 03.6534.00 | 6 |
| 46 | Electrode Wire, Side Burner | 03.6535.00 | 1 |
| 47 | Knob, Control (Main & Side Burners) | 03.6401.00 | 5 |
| 48 | Grid, Side Burner | 03.6407.00 | 1 |
| 49 | Main Burner, Cast Iron | 03.6447.00 | 4 |
| 50 | Burner Pin, Main Burner | 03.5012.00 | 4 |
| 51 | Pan, Foil | Local Purchase | 1 |
| 52 | Pan, Grease | 03.6402.00 | 1 |
| 53 | Drip Tray | 03.5998.00 | 1 |
| 54 | Flame Diffuser SS | 03.6536.00 | 4 |
| 55 | Cooking Grid | 03.5023.00 | 2 |
| 56 | Warming Rack | 03.6449.00 | 1 |
| 57 | Ignition Box | 03.6421.00 | 1 |
| 58 | Shim, Ignition Box | 03.6423.00 | 1 |
| 59 | Regulator/Hose Assembly-(LP Only) | 03.6537.00 | 1 |
| 60 | Ignitor Switch | 03.6426.00 | 1 |
| 61 | Heat Indicator | 03.5033.00 | 1 |
| 62 | Electrode, Main Burner | 03.6427.00 | 2 |
| 63 | Manifold Assembly (LP) | 03.6450.01 | 1 |
| 64 | Left Door, Silver | 03.6443.02 | 1 |
| 65 | Right Door, Silver | 03.6444.02 | 1 |

TOOLS REQUIRED:



Phillips Screwdriver



Pliers

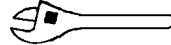

or Wrench

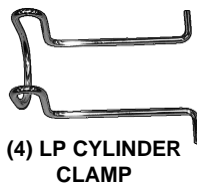

(4) LP CYLINDER CLAMP

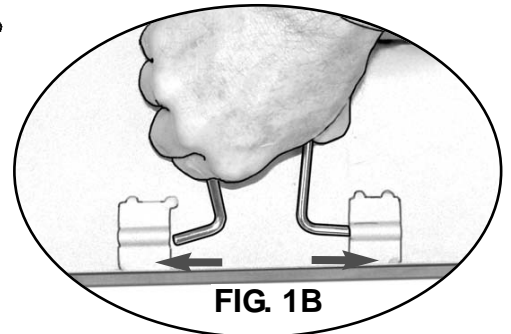

FIG. 1B

CAUTION

To reduce the risk of a cut injury:

- Wear protective gloves when handling parts that have sharp edges.

STEP 1) Cylinder Clamp/Back Panel Assembly:

Lay Back Panel (2/3) on floor. (FIG. 1A) Attach LP Cylinder Clamp (4) to Back Panel by squeezing clamp together to fit into the two slotted openings; then release. (FIG. 1B) Make sure the large loop is down against the panel.

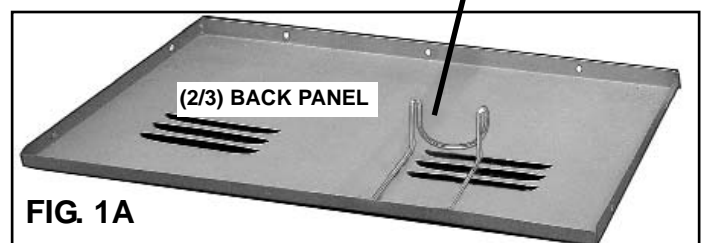

FIG. 1A

STEP 2) Cart Sides and Bottom Assembly:

Lay Back Panel (2/3) on floor. (FIG. 2) Place Bottom Panel (5/6) against Back Panel edge and align the holes. (FIG. 2) Install two M6x15 Bolts (7) through the holes and secure with two M6 Nuts (8).

Attach Bottom Panel Brace (9/10) to Bottom Panel (5/6) with two M6x15 Bolts and M6 Nuts. Attach Back Panel Brace (11/12) to Back Panel (2/3) with two M6x15 Bolts and M6 Nuts. Secure Bottom Panel Brace and Back Panel Brace with one ST4.0 x10mm Screw (13).

Attach Left Side Panel (14/15) and Right Side Panel (19/20) to Bottom Panel with six M6x15 Screws and M6 Nuts.

Install four ST4.0 x10mm Screws (13) from inside the Back Panel to the LEFT Side Panel (14/15) and RIGHT Side Panel (19/20).



ATTACH SCREWS TO
THREADED INSERTS
(TOP INSIDE)

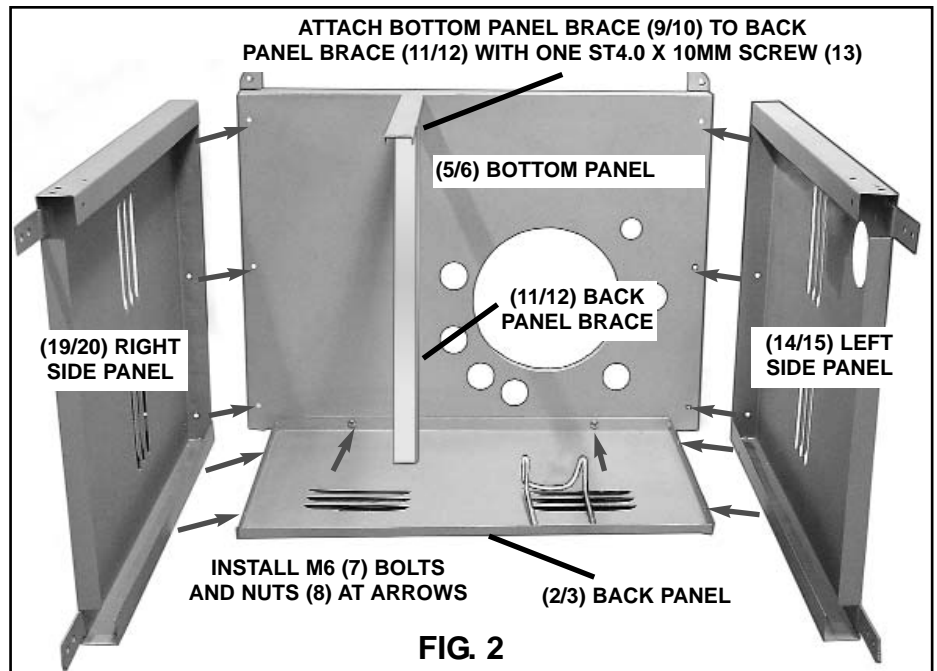
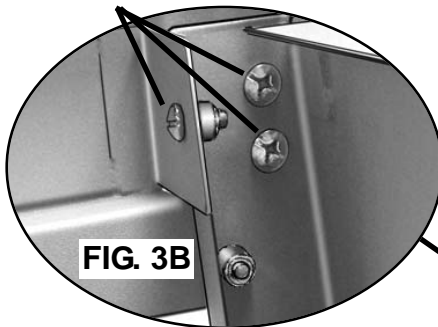

STEP 3) Front Crossbar Assembly:

Turn cart assembly right side up. Attach Front Crossbar (21/22) to side panels with two M6 x 15 screws into the threaded inserts in the ends of Side Panels. (FIG. 3A)

Attach Bottom Panel Brace (9/10) to Crossbar (21/22) with two Screws and Nuts.

On top inside of Crossbar, attach three M6 x 15 Screws through Side Panels into the threaded inserts. (FIG. 3B)

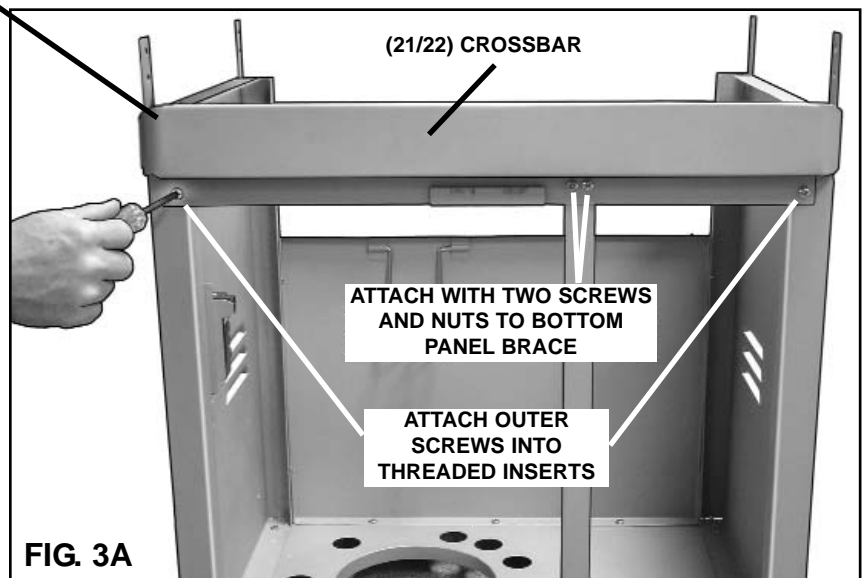

STEP 4) CASTER ASSEMBLY:

Lay cart on the floor with Back Panel side down. Assemble Fixed Casters (23) to the LEFT Side of Bottom Panel and Swivel Lock Casters (24) to the RIGHT Side of Bottom Panel. Insert eight M6x15 Bolts (7) through the caster bracket holes into the threaded holes in the Bottom Panel. (FIG. 4A & 4B) Tighten the screws. Push the lever on the Swivel Lock Caster to lock so the caster wheel does not roll. (FIG. 4C) Set cart assembly up on the the floor.

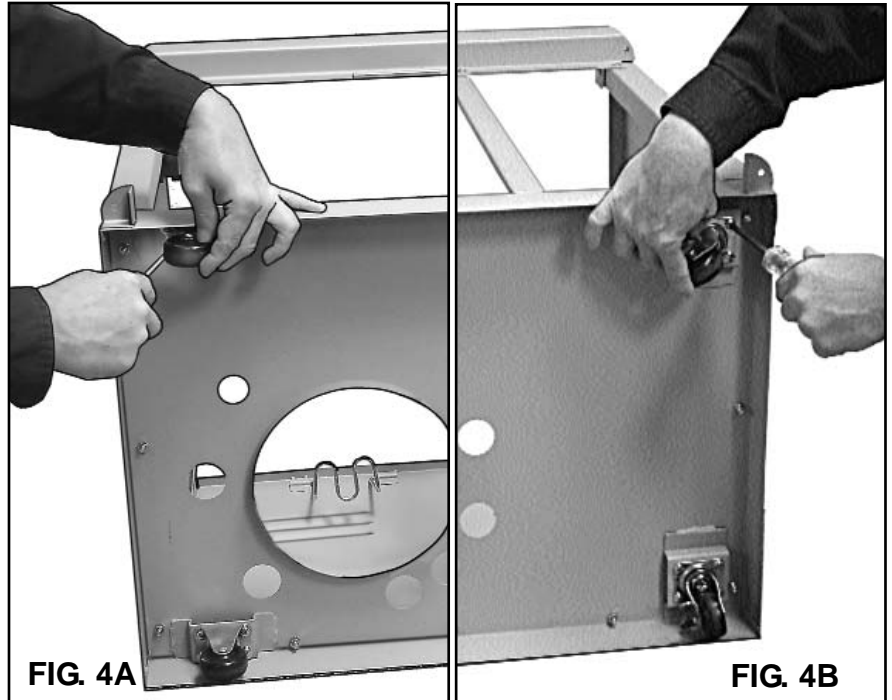
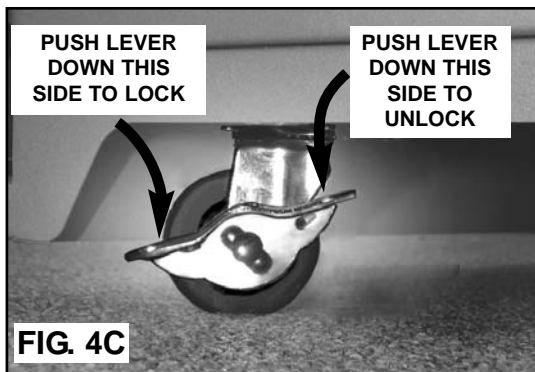
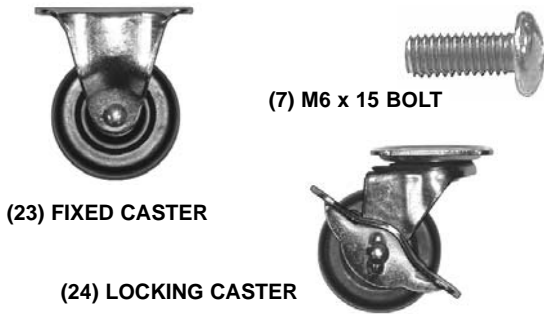

STEP 5) DOOR ASSEMBLY:

Install LEFT Door (26/27) and RIGHT Door (28/29). (FIG. 5A) Note: Hinge Pins are spring-loaded. Drop bottom door pin into Bottom Panel hole. (FIG. 5B) Swing top of door toward hole in top Panel. Depress spring pin with thumb while sliding pin into Top Panel hole until it snaps into place. (FIG. 5C)

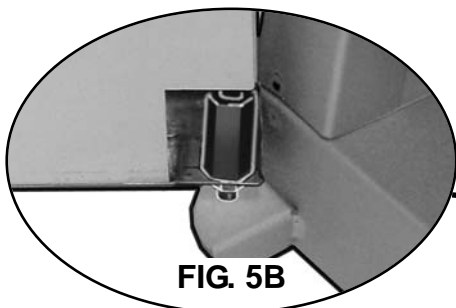
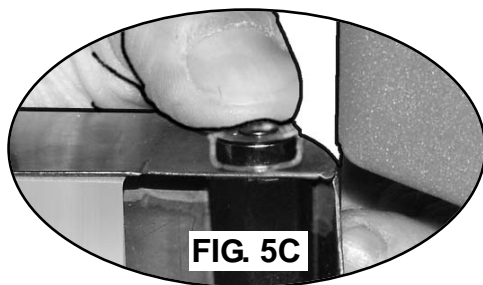

⚠ CAUTION

To reduce the risk of injury from lifting: The following assembly will require 2-people.

STEP 6) HOOD/BOWL TO CART ASSEMBLY:

Lift the Hood/Bowl Assembly (30) over the cart assembly and set it down until it rests on the inside top flanges of the cart. (FIG. 6A)

Align the holes in the side of the Hood/Bowl with the holes in the cart brackets. Insert eight M6x15 (7) Bolts through the holes and tighten after all are installed. (FIG. 6B)

Align the flat keyed hole in the Control Knob (47) with the keyed stem of the four Control valves. (FIG. 6A) Push the Control Knobs onto the four Valve stems.

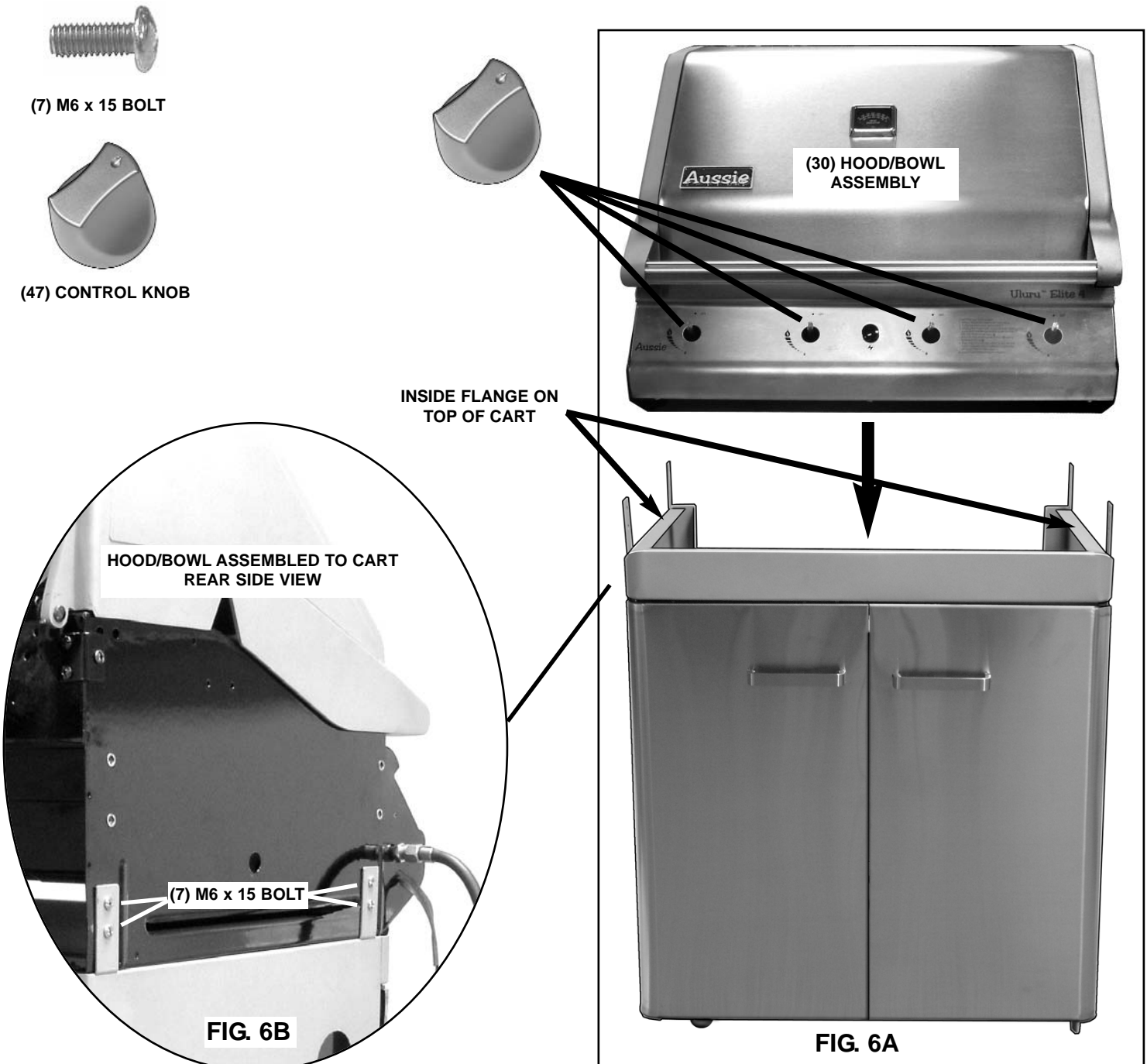

⚠ CAUTION

To reduce the risk of an injury: The following assembly will require 2-people.

STEP 7) BURNER SIDE TABLE ASSEMBLY:

Align the four holes of the LEFT Side Burner Table (36/37) bracket with the threaded inserts in the side of the Bowl. Insert four M6x15 Bolts (7) into the holes and screw them in with a screwdriver, but do not tighten. (Fig. 7A & 7B). Install an M4 x15 Screw (38) at the front of the side Table. Repeat this assembly on the other side of the grill for the RIGHT Side Table (30). Tighten all the screws.



(7) M6 x 15 SCREW



(38) M4 x 15 SCREW



FIG. 7B

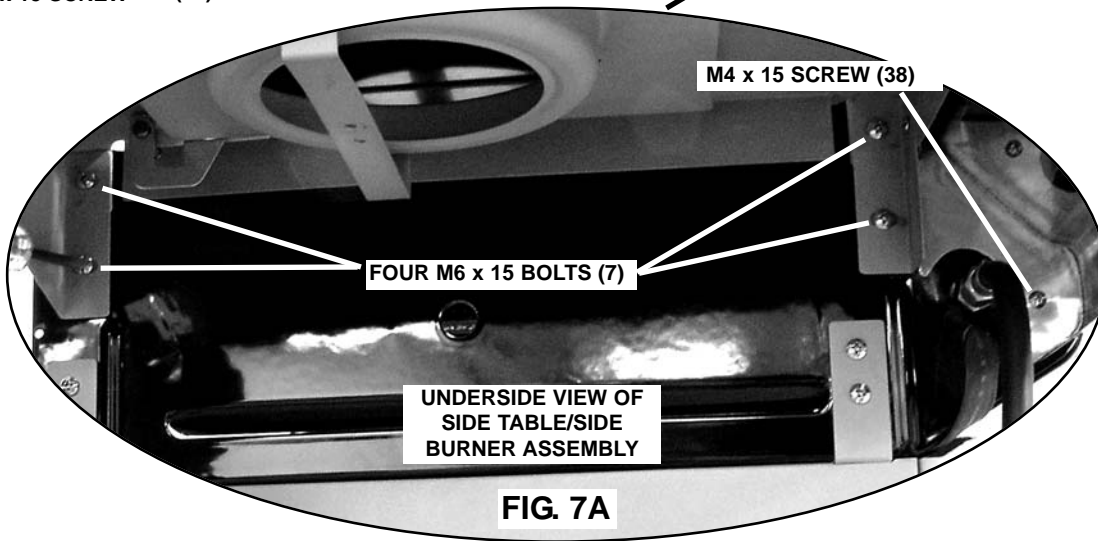

FIG. 7A

STEP 8) SIDE BURNER VALVE ASSEMBLY:

Install the Side Burner Valve (41) from under the bottom of the LEFT Side Table. Note: Side Burner valve is already attached to the hose. (FIG. 8A) Turn the Valve so the nozzle points toward the rear of the Side Table. Install two M5x10mm Screws (42) through top of Side Table and through valve bracket holes. (FIG. 8B) Attach two M5 Nuts (43) to screws and tighten.



(41) SIDE BURNER VALVE



(42) M5 X 10MM SCREW



(43) M5 HEX NUT



FIG. 8A

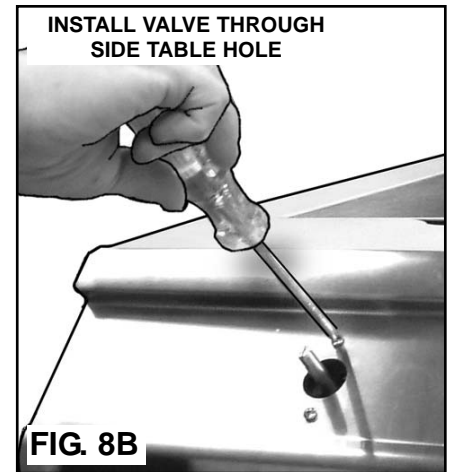
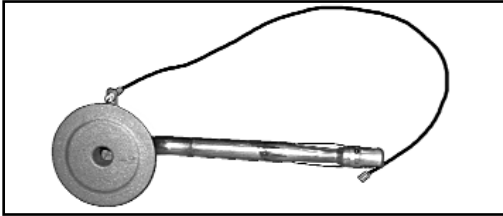

FIG. 8B

STEP 9) SIDE BURNER ASSEMBLY:

Insert the Side Burner (44) and the Electrode Wire through the front of the large hole in the Side Table. (FIG. 9A) Install the burner tube end over the valve nozzle. (FIG. 9B) Secure the Burner to the bracket with two M4x8mm Screws (45). (FIG. 9B) Pass the Electrode Wire through the opening at the top left corner of Side Panel for later connection to Ignition Box. (See also Wiring the Ignition Box.)



(44) SIDE BURNER- (46) ELECTRODE WIRE

(45) M4 X 8MM
SCREW

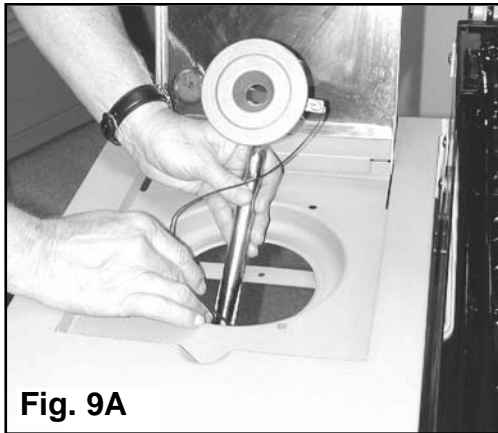
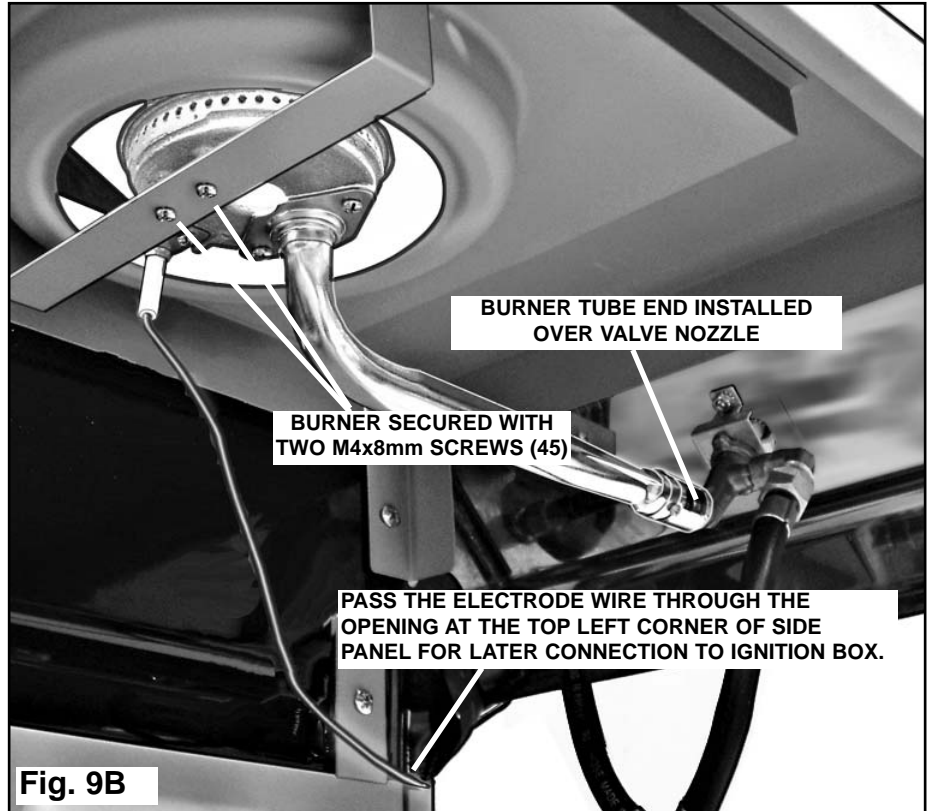

Fig. 9A



STEP 10) SIDE BURNER KNOB/GRID ASSEMBLY:

Align the flat keyed hole in the Control Knob (47) with the keyed stem of the valve. (FIG. 10) Push the Side Burner Knob onto the Valve stem.

Place the Side Burner Grid (48) onto the Side Burner Table letting the three protruded ends fall into the three holes in around the Side Burner.



(47) CONTROL KNOB



(48) SIDE BURNER GRID

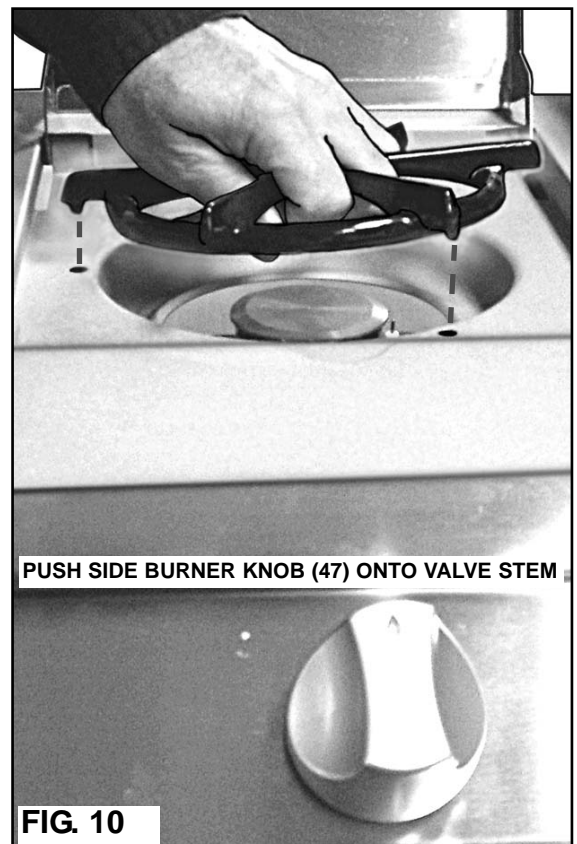

STEP 11) BURNER REMOVAL/RE-ASSEMBLY:

The Burners (49) are already installed in the grill. There is some cardboard packing underneath each burner; it will burn off the first time of use. If you wish to remove it:

1. Remove the burner pin. (FIG. 11A)
2. Lift the burner upwards. (FIG. 11B)
3. Gently pull the burner mouth away from the valve injector. (FIG. 11C)
4. Lift the burner out and remove the cardboard packing. (FIG. 11D)



(49) MAIN BURNER



(50) MAIN BURNER PIN

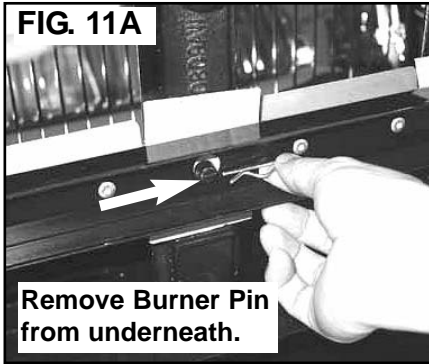

FIG. 11A

Remove Burner Pin from underneath.

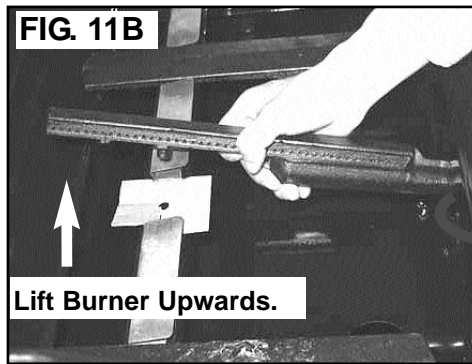
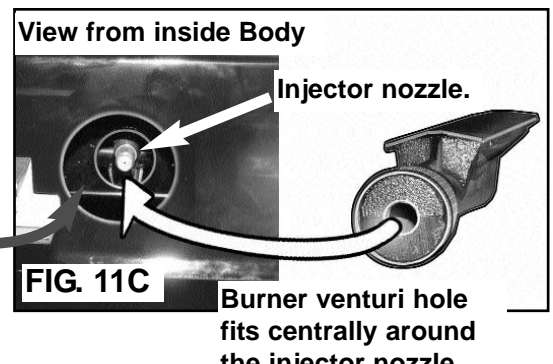

FIG. 11B

Lift Burner Upwards.



View from inside Body

Injector nozzle.

FIG. 11C

Burner venturi hole fits centrally around the injector nozzle.

To install the burners (Follow photos in reverse order):

1. Carefully slide the burner venturi hole over the valve injector nozzle. The Burner venturi hole fits centrally around the injector nozzle.
2. Lower the burner into the body.
3. Insert the locating stud through the support.
4. Lock into place by inserting the burner pin through the stud from underneath.

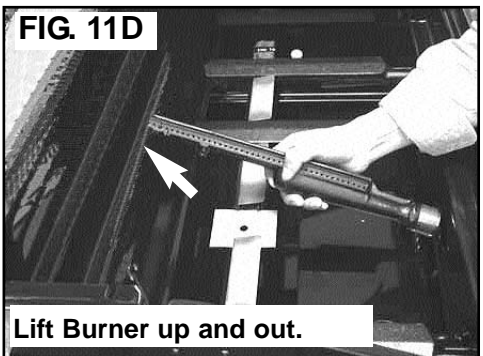

FIG. 11D

Lift Burner up and out.

STEP 12) FOIL PAN/GREASE PAN/DRIP TRAY ASSEMBLY:

Insert the Foil Pan (51) into the Grease Pan (52). Slide the Grease Pan underneath into the guides of the Drip Tray (53). Slide the Drip Tray with Foil pan and Grease Pan into the bottom of the Bowl assembly. (Fig. 12) Secure Drip tray into cart with two ST4.0 x 10 mm Screws.



(13) ST4.0 x 10MM SCREW

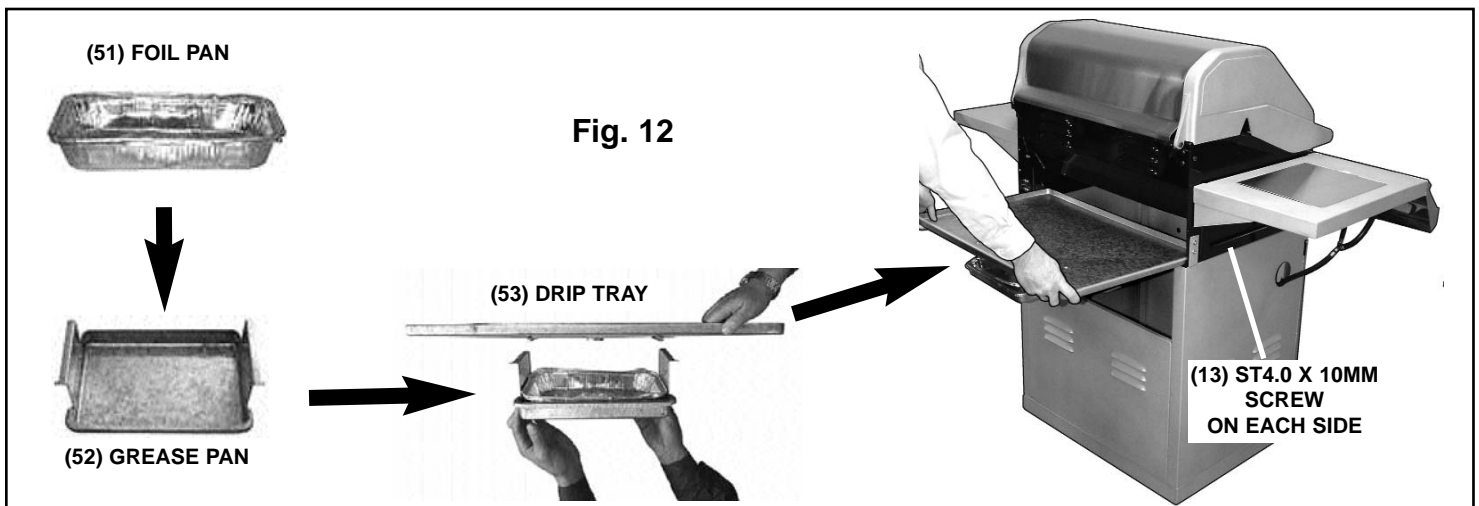

(51) FOIL PAN

Fig. 12

(53) DRIP TRAY

(52) GREASE PAN

(13) ST4.0 X 10MM SCREW ON EACH SIDE

STEP 13) FLAME DIFFUSER/GRID/ WARMING RACK ASSEMBLY:

Lay a Flame Diffuser (54) over each Burner on the lower Body ridges from front to back. Place each Flame Diffuser in the individual guides to keep from sliding. (FIG. 13A)

Place the Cooking Grids (55) over the Burner Diffusers on the upper Body ridges. (FIG. 13B)

Insert the ends of the Warming Rack (56) into the V-shape hangers at each end of the hood. (Fig. 13C)



(54) FLAME DIFFUSER

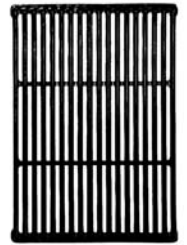

(55) COOKING GRID



(56) WARMING RACK



Fig. 13A



Fig. 13B

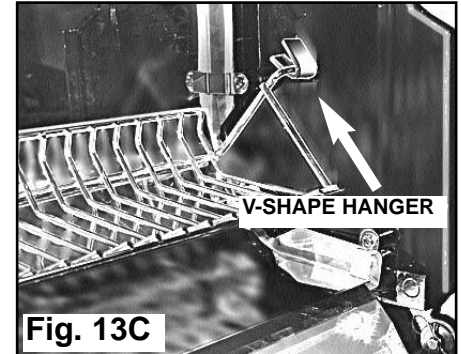

Fig. 13C

STEP 14) WIRING THE IGNITION BOX:

- Route the wiring through the top left side of the Crossbar to the inside of cabinet. (Fig. 14A).
- Hold the Ignition Box (57) in your hand. (Fig. 14B)
- Attach BLACK wire from Side Burner and RED and Blue wires from Main Burners to terminals 1, 2 and 3.
- Attach LARGE BLACK wires from Ignitor Switch to the pair of terminals on the LOWER right side of the Ignition Box.
- Install a 9-Volt battery with positive (+) terminal shown on Ignition Box.

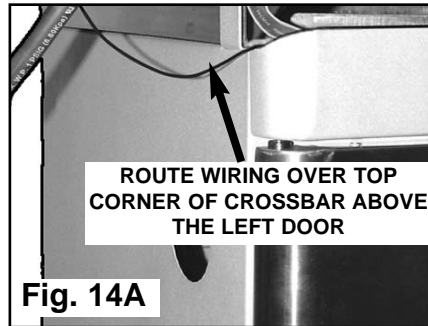

Fig. 14A

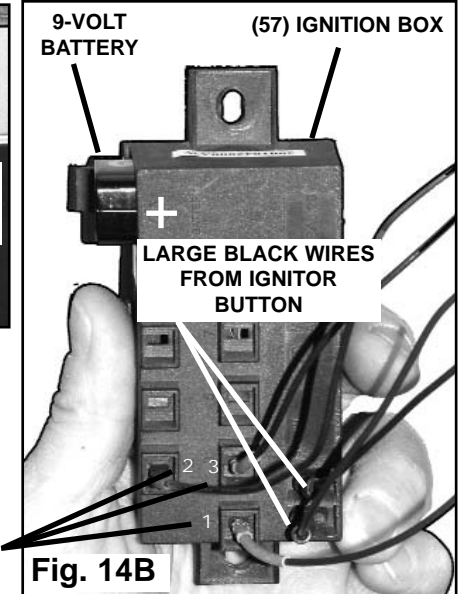

Fig. 14B

STEP 15) INSTALL THE IGNITION BOX:

Align the Ignition Box Shim (58) and Ignition Box (57) with mounting plate on inside of LEFT Side Panel. Attach the Ignition Box and Shim with two ST4.0 X 10MM Screws (13). (Fig. 14C)



(13) ST4.0 x 10MM SCREW



(58) IGNITION BOX SHIM

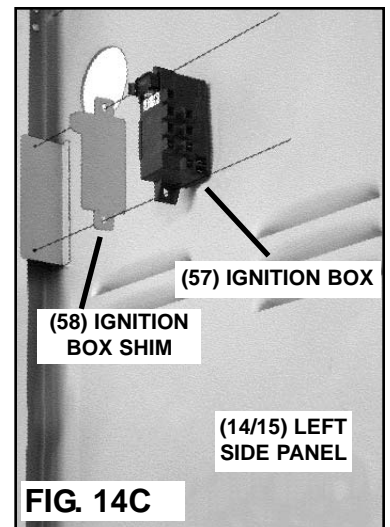

FIG. 14C

This completes assembly of the grill.

CONNECTING/DISCONNECTING THE GAS

USING GAS

DANGER

CARBON MONOXIDE HAZARD

- This appliance can produce carbon monoxide which has no odor. Using it in an enclosed space can kill you.
- Never use this appliance indoors, on recreational vehicles, or boats.

WARNING

To reduce the risk of serious bodily injury or death:

- Use only propane gas in this LP gas grill.
- Do not attempt to convert an LP unit to natural gas.
- Any use or alteration of this unit not intended could be unsafe and will void your warranty.
- Always use a gas appliance outdoors in an open area with good ventilation to avoid breathing toxic fumes from leaking gas, explosion or fire. As with all conventional fuels, the burning process consumes oxygen and produces toxic gases, including carbon monoxide. In addition, the combustion products of such fuels, including liquefied petroleum (LP), contain chemicals known to the state of California and other authorities to cause cancer, birth defects and other reproductive harm.

LP CYLINDER

WARNING

To reduce the risk of serious bodily injury, fire or death:

- Read and follow all warnings on LP gas cylinder.
- If you see, smell, or hear the hiss of LP gas escaping from the cylinder:
 1. Do not attempt to light appliance.
 2. Extinguish any open flame.
 3. Disconnect from fuel supply.
- Do not operate the LP gas grill without the LP gas cylinder secured to the cart and oriented as shown in Assembly Instructions for Connecting the LP Cylinder.
- Never connect or disconnect LP gas cylinder or fittings while grill is in use or is hot.
- When the LP gas cylinder is connected, keep the grill outside in a well-ventilated space.
- Do not use an LP gas cylinder if it shows signs of dents, gouges, bulges, fire damage, corrosion, leakage, excessive rust or other forms of visual external damage; it may be hazardous and should be checked by a liquid propane supplier. Do not use an LP cylinder with a damaged valve.
- Do not store a spare LP gas cylinder under or near the LP gas grill.

- When grill is not in use, turn off all grill control knobs, LP cylinder valve and disconnect LP cylinder.
- Never fill the LP gas cylinder more than 80% of cylinder volume. (20 lb. maximum) Do not ask the propane supplier to over-fill the cylinder.
- If you obtain LP gas through a cylinder exchange dealer, make sure you get a safe and adequate O.P.D. cylinder. (See page 23) Use only a licensed LP gas cylinder dealer.

· The LP gas cylinder, for use with this LP gas grill, must meet the following requirements:

- 1) 12" diameter x 18" tall, 20 lb maximum capacity
- 2) Overfill Protection Device (OPD) safety feature (should be noted on cylinder)
- 3) Must be constructed and marked in accordance with Specifications for LP-Gas Cylinders of the U.S. Department of Transportation (DOT) or the National Standard of Canada, CAN/CSA-B339, Cylinders, spheres and Tubes for Transportation of Dangerous Goods; and Commission, as applicable (See collar for marking)
- 4) Must have collar to protect LP cylinder valve.

LP HOSE AND REGULATOR

WARNING

To reduce the risk of serious bodily injury or death:

- Clean and inspect the gas hose/regulator before each use of the outdoor cooking gas appliance. The gas hose/regulator must be replaced prior to being used, if there is evidence of excessive abrasion or wear, or if the hose is cut or leaks.
 - Use only the gas hose/regulator assembly that has been supplied with this gas grill. Do not use hose/regulator from another manufacturer.
 - Always check for gas leaks when you connect and disconnect the hose/regulator to the LP gas cylinder, especially after a period of storage (for example, over winter).
 - Make sure there are no sharp bends in the hose.
 - Make sure hose/regulator does not contact any heated surfaces.
- If the hose/regulator assembly is not working properly and you need a replacement, contact the manufacturer (1-800-251-7558). Be sure to specify your grill model.

Connecting the LP Cylinder:

- 1) Fill empty OPD LP Cylinder at your local LP gas supplier.
- 2) Lift up LP Cylinder Clamp and set LP Cylinder in the Large hole inside the Bottom Panel. Lower the clamp over the Cylinder Collar. Rotate the LP Cylinder so the Cylinder nozzle is toward the door opening. **(Fig. 15A)**
- 3) Remove the protective cap from the LP Cylinder valve. (Save cap for re-capping.) Hold Regulator in a straight line with LP Cylinder valve so the connection does not cross thread. Insert Regulator Nipple into the LP Cylinder valve. **(Fig. 15B)** Hand tighten coupling nut in clockwise direction. Do not use tools.

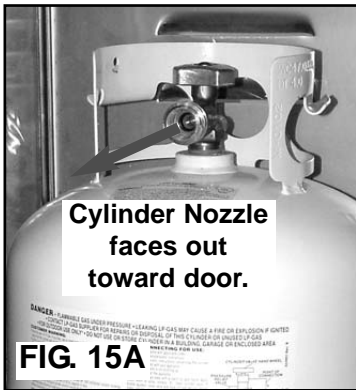

Disconnecting LP gas cylinder:

- 1) Turn all control knobs to the “off” position and turn the handle on the LP gas cylinder clockwise until it stops.
- 2) Turn coupling nut on regulator counterclockwise until regulator is released from the threaded LP cylinder gas nozzle.
- 3) Place the protective cap over LP cylinder gas nozzle.

OPERATING AND MAINTAINING YOUR GAS GRILL

BEFORE USING YOUR LP GAS GRILL

INSTALLATION CODES

⚠ WARNING

To reduce the risk of serious bodily injury or death:

- This installation must conform with local codes or, in the absence of local codes, with either the National Fuel Gas Code, ANSI Z223.1/NFPA 54 Natural Gas and Propane Installation Code, CSA B149.1, or Propane Storage and Handling Code, B149.2 or the Standard for Recreational Vehicles, ANSI A 119.2/NFPA 1192 and CSA Z240 RV Series, recreational Vehicle Code, as applicable.

- If an external electrical source is utilized, the outdoor cooking appliance, when installed, must be electrically grounded in accordance with local codes or, in the absence of local codes, with the National Electrical Codes, ANSI/NFPA 70, or the Canadian Electrical Code CSA C22.1.
- Keep any electrical supply cord away from any heated surfaces.

SELECTING A LOCATION

⚠ WARNING

- To reduce the risk of serious bodily injury or death:
- This outdoor cooking appliance shall be used only outdoors and shall not be used in a building, garage, or any other enclosed area. Locate outdoor cooking appliance in an area with good ventilation on a level stable surface clear of combustible and flammable material.
 - Maintain minimum clearances of 36” from back and sides of grill to any combustible construction.
 - Do not locate this appliance under overhead unprotected combustible construction.
 - This outdoor cooking appliance is not intended to be used in or on boats or installed in or on recreational vehicles.
 - Do not use gas grill as a space heater.

PERFORMING A LEAK TEST

⚠ WARNING

- To reduce the risk of serious bodily injury or death:
- Perform a leak test before each use and each time a gas connection or disconnection is done .
 - Perform a leak test in a well ventilated area.
 - Never use an open flame to test for gas leaks.
 - Never smoke near the grill during a leak test.
 - Do not perform a leak test on a grill while it is hot or in use.
 - Do not use the gas grill if you detect a gas leak that cannot be corrected by using the leak test procedures.

Before using your gas grill perform a leak test on the Control Valves, Hose/Regulator connections and fittings.

How to perform a leak test:

Supplies Needed for a Leak Test: Clean paint brush, water, and dish washing liquid.

- 1) Use an LP Cylinder equipped with an OPD (Overfill Prevention Device) and have it filled at an authorized LP gas dealer by a qualified attendant.
- 2) Make sure all of the grill control panel knobs are turned to the "off" position and verify that the LP gas cylinder valve is closed by turning the knob on the LP gas cylinder clockwise until it stops.
- 3) Mix one part of water with one part of dish washing liquid.
- 4) Remove control knobs and the three retaining screws at the bottom of the control panel. **(FIG. 16A)**
- 5) Remove front control panel cover. Detach the wire leads from the starter button underneath the control panel. Set control panel aside.
- 6) Turn the knob on the LP gas cylinder counter-clockwise. **(FIG. 16B)**
- 7) Check for leaks by brushing the soap solution on all gas valves, hose connections and fittings. (shown by the heavy arrows in **(FIG. 16C, 16D & 16E)**) Make sure you generously brush the locations with the soap solution, completely surrounding the connections and fittings.
- 8) If "growing" bubbles appear on any of the connection points, you have detected a gas leak. Immediately close the LP cylinder valve by turning handle clockwise.
 - A) If leak appears at either end of hose and regulator assembly, retighten the connection at the leak, but do not overtighten. (Note: Only hand tighten at coupling nut) Repeat Leak Test.
 - B) If the leak is coming from the Gas Cylinder, from the valves at the control knobs, or if the leak cannot be stopped, do not use the grill. Call Customer Service at 1-800-251-7558.
- 9) Upon completion of leak test, turn all control knobs to the "off" position. Turn the handle on the LP gas cylinder clockwise until it stops. Disconnect LP gas cylinder by turning coupling nut on regulator in a counter clockwise direction until regulator is released from threaded LP cylinder gas nozzle.

10) Place the protective cap over LP cylinder gas nozzle.

11) Attach the wire leads to the Ignitor button and Replace control panel with the three screws

After completing Leak Test, you are ready to begin using your grill!

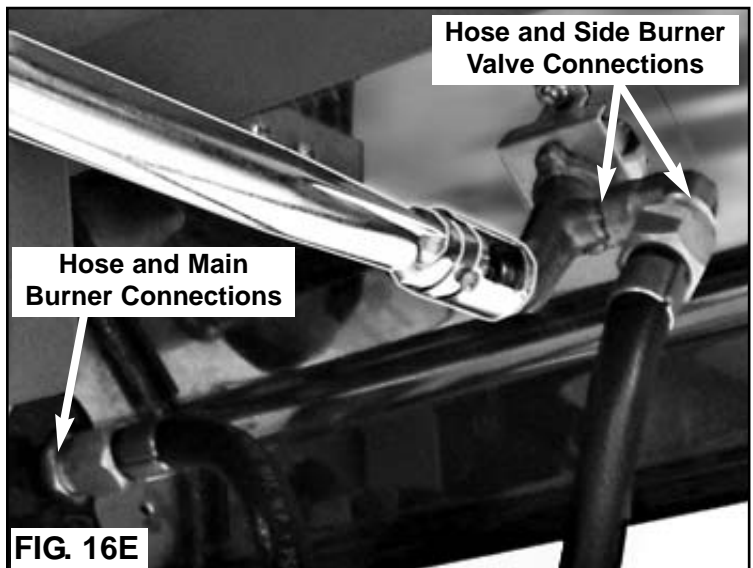
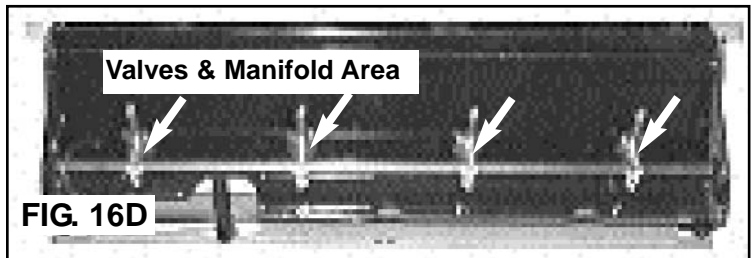
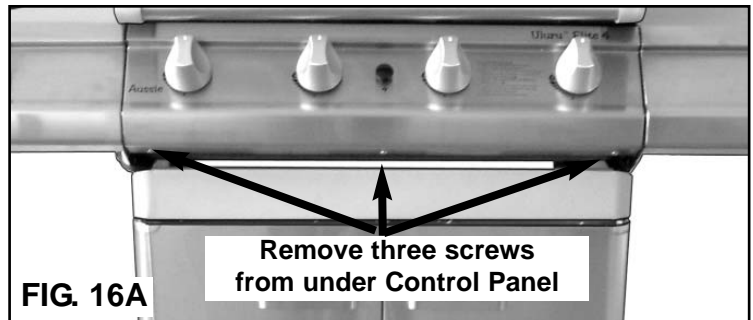

LIGHTING THE GRILL USING THE PULSE-SPARK IGNITOR

⚠ WARNING

To reduce the risk of serious bodily injury or death:

- Open Hood before lighting the grill to prevent an explosion from gas build-up.
- During failed lighting attempts, or if the burners go out during operation, turn control knobs "Off" to dissipate any accumulation of gas. Wait five minutes before repeating lighting procedure.

1. Open the Hood.
2. Important: Make sure control knobs are turned "Off". (FIG. 17B)
3. Turn the LP Gas Cylinder valve open counter-clockwise until it stops. (FIG. 17A)
4. Push far left control knob in and turn counter-clockwise to the High position. (FIG. 17C & 17D)
5. Pause 4 seconds and push the ignitor button in for 2-3 seconds to light the burner. Listen for the spark ignition and look to make sure the burner is lit. If no spark, see (FIG. 17E) and [Troubleshooting Section](#).
6. From the "Off" position, light all other burners from left to right, making sure each burner is lit before lighting the next. Your grill has a crossover ignition system that allows the burners to light successively off one another. Confirm each burner is lit before lighting another burner.
7. If the burner fails to light, repeat Step 3. If it still does not light, try the next burner from left to right.

If a burner goes out during operation, turn all knobs to the "Off" position and close the LP cylinder valve or the natural gas supply valve to dissipate any accumulated gas. Open hood and wait five minutes before attempting to relight the grill.

If any or all burners fail to light after three or four attempts following Steps 4-7, turn all knobs to the "Off" position and close the LP gas cylinder valve to dissipate any accumulated gas. Wait five minutes; then repeat the lighting procedures. NOTE: If the burners still fail to light, refer to the [Troubleshooting Section](#). The burner can also be lit manually, see [Manual Lighting of the Grill](#).

Turn LP Gas Cylinder valve counter-clockwise.



FIG. 17A

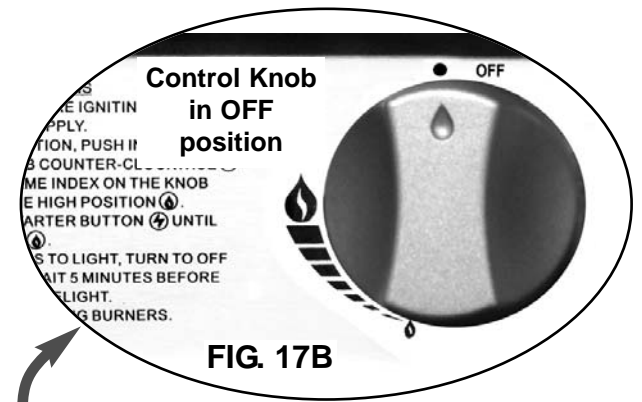

FIG. 17B

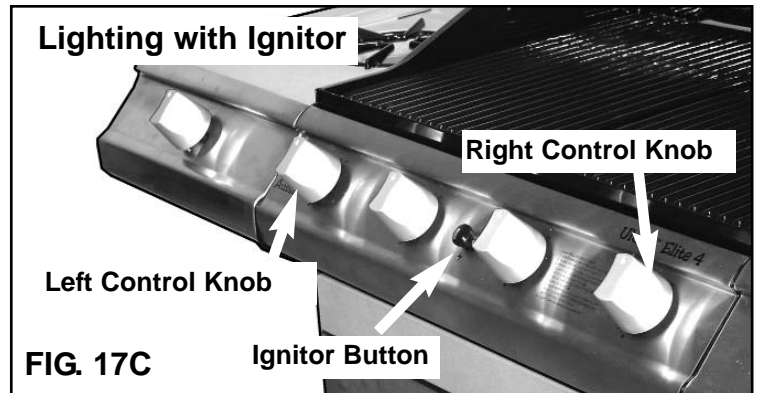

FIG. 17C

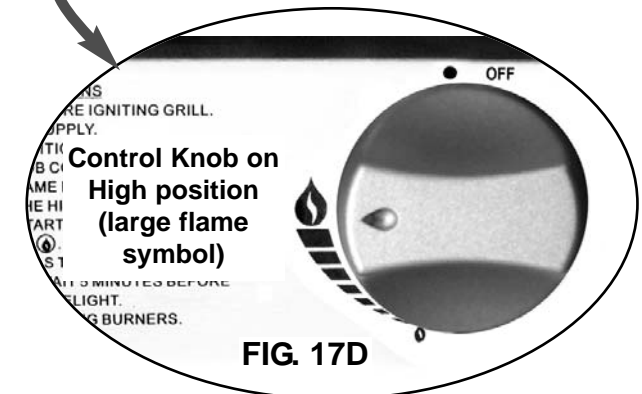

FIG. 17D

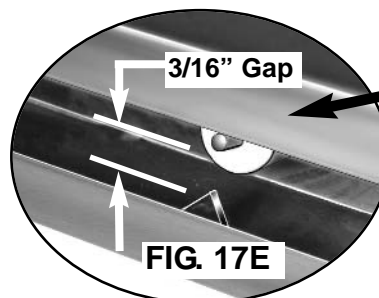

FIG. 17E

Gas Collector Box-If no spark, pinch together or open Gas Collector Box to adjust 3/16" gap between electrode tip and V-notch.



MANUAL LIGHTING THE GRILL

⚠ WARNING

To reduce the risk of serious bodily injury or death:

- Open Hood before lighting the grill to prevent an explosion from gas build-up.

1. Open the Hood.
2. Important: Make sure control knobs are turned "Off". (See FIG. 17B)
3. Turn the LP Gas Cylinder valve open counter clockwise until it stops. (See FIG. 17A)
3. Locate either the left or right match lighting hole you intend to use underneath the grill bowl. Push in and turn either the far left or far right control knob near the match lighting hole counter-clockwise to the "High" position. (See FIG. 17C & 17D)
4. Insert a lit match through the match-lighting hole using the match holder. (FIG. 18A & 18B)
- 5) From the "Off" position, light all other burners from left or right, making sure each burner is lit before lighting the next. Your grill has a crossover ignition system that allows the burners to light successively off one another. Confirm each burner is lit before lighting another burner.

If any or all burners fail to light after three or four attempts following Steps 3-4, turn all knobs to the "Off" position and close the LP gas cylinder valve to dissipate any accumulated gas. Wait five minutes; then repeat the lighting procedures. NOTE: If the burner still fails to light, refer to the [Troubleshooting Section](#).

8. After ignition, turn the control knobs to "High" for 3-5 minutes and close the Hood to preheat the grill. Preheat the grill before every cooking session.)

If a burner goes out during operation, turn all knobs to the "Off" position and close the LP cylinder valve to dissipate any accumulated gas. Open hood and wait five minutes before attempting to relight the grill.

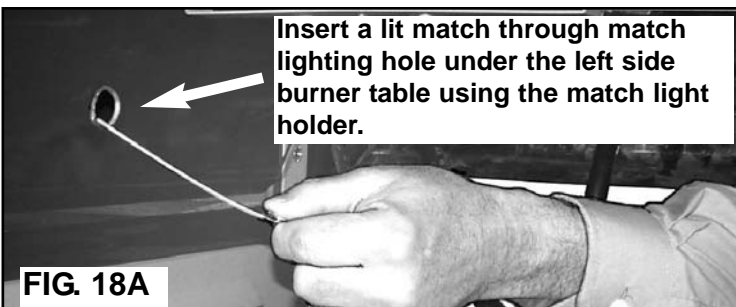

LIGHTING THE SIDE BURNER

⚠ WARNING

To reduce the risk of serious bodily injury or death:

- Open Side Burner Lid before lighting the grill to prevent an explosion from gas build-up.

1. Open the side burner lid. (FIG. 18C)
2. Important: Make sure Side Burner Control Knob is turned "Off" first. (See FIG. 17C)
3. Turn the LP Gas Cylinder valve open counter clockwise until it stops. (See FIG. 17A)
4. Push side burner control knob in and turn counter clockwise to the High position. (See FIG. 17D)
5. Pause 4 seconds and push the ignitor button (main control panel) in for 2-3 seconds to light the burner. Listen for the spark ignition and look to make sure the burner is lit. If no spark, see (FIG. 20F page 20) and [Troubleshooting Section](#).
6. If the burner fails to light, repeat Step 3.

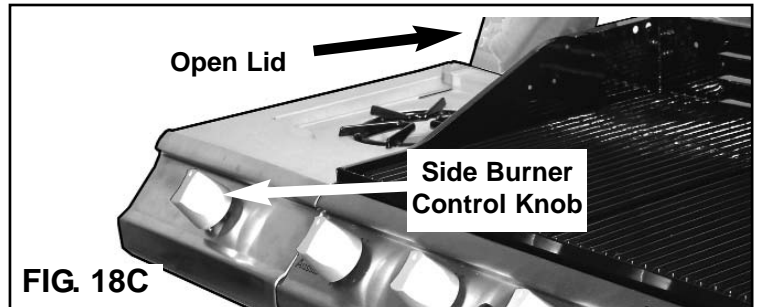

If the burner fails to light after three or four attempts following Steps 3-6, turn the side burner control knob to the "Off" position and close the LP gas cylinder valve to dissipate any accumulated gas. Wait five minutes; then repeat the lighting procedures. NOTE: If the burners still fail to light, refer to [Troubleshooting Section](#). The burner can be lit manually, see [Manual Lighting the Side Burner](#).

CHECK YOUR FLAME

Your burners have been preset by the manufacturer for optimal flame performance. A blue flame, possibly with a small yellow tip, is the result of the optimal air and gas mixture. (See diagram below)

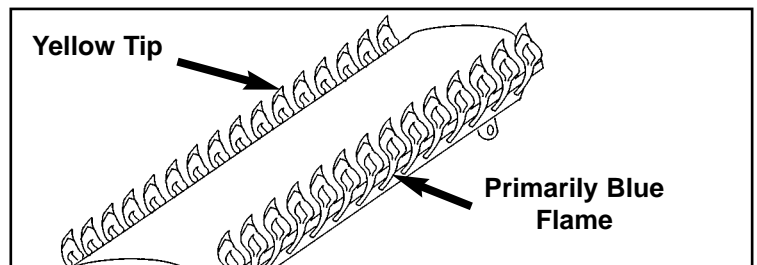

Check the flame before each cooking session and throughout the grilling season. Also check especially after long periods of storing the grill. If the flame is significantly yellow in color, the appropriate amount of LP gas in the air/LP gas mixture is not correct. This could be due to a blocked burner from grease drippings or from insects building a nest inside the burner or burner opening. See [How to Clean the Burners](#).

MANUAL LIGHTING THE SIDE BURNER

⚠ WARNING

To reduce the risk of serious bodily injury or death:

- Open Side Burner Lid before lighting the grill to prevent an explosion from gas build-up.
- When manually lighting side burner, use matchlight holder to avoid burns.

1. Open the side burner lid.
2. Important: Make sure Side Burner Control Knob is turned “Off” first.
3. Turn the LP Gas Cylinder valve open counterclockwise until it stops. (FIG. 18A)
4. Push side burner control knob in and turn counterclockwise to the High position. (FIG. 19)
5. Hold Lit Match near Burner.
6. If the burner fails to light, repeat Step 3 & 4.

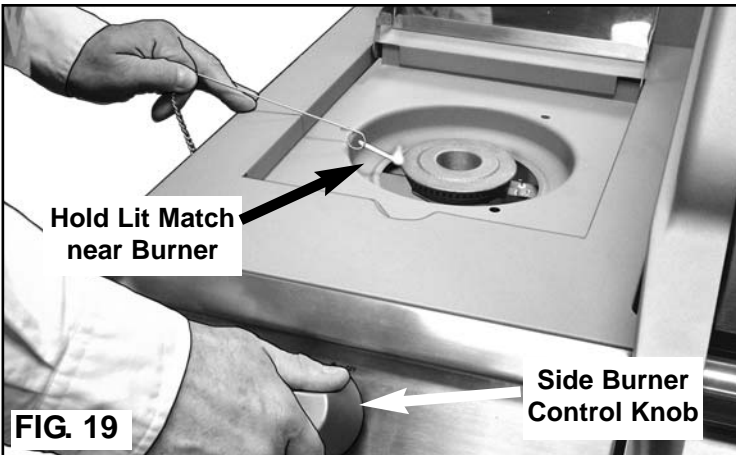

If the burner fails to light after three or four attempts following Steps 3-6, turn the side burner control knob to the “Off” position and close the LP gas cylinder valve to dissipate any accumulated gas. Wait five minutes; then repeat the lighting procedures. NOTE: If the burners still fail to light, refer to [Troubleshooting Section](#).

GRILL COOKING

⚠ WARNING

To reduce the risk of serious bodily injury, death or grill damage:

- Do not cover more than half (50%) the cooking area if using griddle plates. Full coverage of cooking area will cause overheating below the plates.
- Always make sure the Foil Pan, Grease Pan and Grease Tray are empty and are properly installed under the Bowl before each cooking.
- Do not leave any utensils on a hot Cooking Grid or cookware.

Cooking on the Grids: The burners heat up the Flame Diffusers under the Cooking Grids, which in turn heat the food on the grill. The natural food juices from cooking fall onto the hot Flame Diffusers below and vaporize. Rising smoke bastes the food, giving it that unique barbecued flavor.

Cooking on Griddle Plates allow cooking of smaller items that otherwise, would fall through the grill. The burners heat the Griddle Plate directly, which cooks the food on contact. The Plates sear cuts of meat or cook food like eggs that can not be cooked on a grill. They can also be used to heat pans.

CAUTION

- Do not preheat griddle plates over 5 minutes. The cooking surface coatings could be destroyed.
- Use only long-handled heat resistant plastic or wooden utensils to avoid scratching the non-stick surface.

WARMING RACK

Warming racks are a convenient way to keep cooked food warm or to warm items such as bread or rolls. When opening the hood, be alert of dripping fat from the warming rack which could then drip onto the barbecue causing a mess. Always check that your warming rack is properly fitted before use. Do not cook food on the warming rack. See Roasting below.

ROASTING HOOD COOKING

⚠ WARNING

To avoid burns from the hot air and steam trapped inside:

- Open the hood carefully when grill roasting.

Closing the Hood forms an ‘oven’ and traps a large amount of heat for roasting whole meats, chickens, etc. Therefore, it is IMPORTANT that the burners are turned to the “Low “ position to prevent burning of the food.

To contain juices and fat, place the food to bake or roast in a metal baking tray to one side of the cooking grid. Turn the burner side directly under the tray to the ‘Off’ position and the burner side opposite the food to the ‘Medium’ position. Close the hood and cook ‘indirectly’. Monitor the temperature with the Hood gauge. If the heat gets too high, turn the burner to the ‘Low’ position. Avoid lifting the hood frequently as heat is lost each time.

OPERATING THE GAS GRILL

⚠ WARNING

To reduce the risk of serious bodily injury or death:

- Never use charcoal in your gas grill. Keep this outdoor cooking appliance clear and free from combustible materials, gasoline and other flammable vapors and liquids.
- Keep any electrical supply cord and regulator hose away from any heated surfaces.
- Make sure there are no gas leaks or obstructions to the flow of combustion and ventilation air before each use.
- Keep the ventilation openings of the LP cylinder enclosure free and clear from debris.
- To prevent an explosion from gas build-up, always open the hood before lighting the LP gas grill.

- Do not attempt to extinguish a grease fire with water or other liquids. Have an BC fire extinguisher accessible. Do not douse or spray the grill or cooking surfaces with water when hot. Burns from grease or the water splatters could occur.
- If your gas grill catches on fire:
 - If the fire is in the grill portion and you can safely reach the control knobs on the control panel, then turn them to the off position.
 - If the fire is in one of the hoses, and you can safely reach the LP cylinder valve, then shut the valve off.
 - If the fire involves the cylinder, leave it alone, evacuate the area and call the fire department.
 - If there is any type of fire that threatens either personal safety or endangers property, call the fire department.
- Do not use the grill without Drip Tray, Grease Pan, and Foil pan in place. Check the Foil pan and Grease Tray for grease buildup. Empty excess grease to avoid a grease fire in the pan.
- If you notice grease or other hot material dripping from the grill onto the valve, hose, or regulator, turn off the gas supply immediately. After the grill has cooled, determine the cause and correct it. After cleaning the valve and hose and regulator assembly, perform a leak test before continuing use. (See Performing a Leak Test.)
- Do not operate a gas grill if you have knowledge of or suspect a gas leak.
- Do not wear loose clothing (example: hanging shirt tails, clothing with frills, etc.) around a gas grill while in use or hot.
- Do not lean your body over the gas grill when lighting it or while it is in use or hot.
- Do not touch hot surfaces. Use heat resistant gloves, long-handled tongs, or cooking mitts at all times since the grill will become very hot. Open the hood carefully when cooking to avoid burns from the hot air and steam trapped inside.
- Do not allow children to operate or play near a gas grill. Keep animals and bystanders out of the grill area. Do not leave grill unattended.
- Do not move an LP gas grill when in use or hot.
- When grill is not in use, turn off all grill control knobs, LP cylinder valve and disconnect the LP cylinder.

END OF COOKING SESSION

WARNING

- To reduce the risk of serious bodily injury, fire or death:
- Allow grill and the grease in the Foil pan to completely cool before emptying, handling parts, cleaning, moving or storage.
 - Empty the Foil pan and Grease Pan after each cooking session so excessive grease does not accumulate.
 - Never light the LP gas grill without the Foil pan, Grease Pan and Drip Tray in place.

- 1) After each cooking session, close the hood and turn the grill burners to the "High" position and burn for five minutes. This will burn off some cooking residue, thus making cleaning easier. (Side Burner not affected.)
- 2) When you have finished using your grill, turn the grill Control Knobs clockwise to the "Off" position.
- 2) Turn off the gas at the LP cylinder valve by turning the handle clockwise until it stops.
- 3) Wait until the grill is cool before closing the hood, cleaning or putting on a grill cover.
- 4) Regularly clean your LP gas grill between uses and after extended storage periods. To maintain the condition and extend the life of your grill, we strongly recommend that the unit be covered when stored outside for any length of time, especially during the winter months.

CARE AND MAINTENANCE

CAUTION

To reduce the risk of a cut injury:

- Be careful or wear protective gloves when cleaning grill parts that have sharp edges.

CLEANING THE GRILL

- A) **Drip Tray, Grease Pan, Foil Pan**-Loosen the two screws on the sides holding the Drip Tray. Remove and scrape away food and fat residue from the drip tray. Empty and wash the Foil Pan and Grease Pan with hot soapy water and a cloth. The Foil Pan can be replaced with a standard size foil pan (approx. 5-1/2" W x 8-1/2" L x 1-1/8" H) from your local grocer or retail store.
- B) **Grill Body and Cabinet**-Remove excess grease and/or fat with a soft plastic or wooden scraper. Do not use steel, wool or other abrasive cleaners that can scratch painted, porcelain coated or stainless steel surfaces. It is not necessary to remove all the grease from the body. Wipe it down with paper towels or soft damp cloth.
- C) **Warming Rack**-Clean if necessary.
- D) **Cooking Grid/Flame Diffusers.** Clean the residue off with a baking soda and water solution. For stubborn stains, use a non-abrasive scouring powder. Do not use steel, wool or other abrasive cleaners that can scratch the stainless steel or porcelain coated surfaces. This can cause foods to stick on the Cooking Grids.
- E) **All other Cleaning**-For further cleaning, use hot soapy water and a cloth, or nylon-bristled brush only. Do not immerse the gas controls or manifold in water. (Avoid getting water in the Burner Holes.)
- F) **Burners**-Burning off the residue after cooking will keep the burners clean with normal usage, provided the Burners are operating correctly. Clean the the Burners annually, or whenever heavy build-up is found, to ensure that there are no signs of blockage (debris, insects) in either the burner portholes, the primary air inlet, or the neck of the burners. **(See Burner Cleaning instructions.)**
- G) After cleaning, replace all the cleaned parts. Re-tighten Drip Tray screws.

⚠ WARNING

To reduce the risk of a fire beneath the grill:

- Inspect and clean burner/venturi tubes for insects and insect nests.
- Be sure burners are re-installed properly before using grill.

How to Clean the Burners:

A) Make sure the LP cylinder grill control knobs are turned OFF; and the grill is completely cooled.

B) Carefully remove Cooking Grids and Flame Diffusers.

C) To remove main burners, remove the burner pin from each burner peg located at rear end of burner. (FIG. 20A) Leave side burner in place. (See G.)

D) Lift each main burner from the grill. (FIG. 20B) Gently pull the burner mouth away from the valve nozzle. (FIG. 20C)

E) Use a pipe cleaner to clear insect nests from the inlet hole of main burner (FIG. 20D) and side burner ventilation hole. (FIG. 20E)

F) Open up the main burner holes (FIG. 20D) and the side burner holes (FIG. 20F) with a small nail or wire. Use a brass wire brush to remove food particles and corrosion from the burner surfaces. Note: It is normal for surface rust to be present on the burners.) It can be wire brushed and coated with cooking oil periodically. Verify that there are no insects or insect nests blocking the inlet hole.

G) Check the side burner electrode to see if it is loose. If so, tighten the screw holding the electrode to maintain 3/16" gap between electrode tip and side burner. Note: Before next step you may wish to clean the rest of the Grill. (See Grill Body and Cabinet)

H) After cleaning, refit the Burners. Note: When refitting the Burners, be sure each burner is positioned correctly. The valves should protrude inside the venturi ends of the burner. (FIG. 20C) Replace the Burner pin under each burner.

I) If grill is to be stored, coat Burners lightly with cooking oil and wrap in a protective cover to keep insects out.

J) Check burner operation after re-assembly.

K) Replace Flame Diffusers and Cooking Grids.

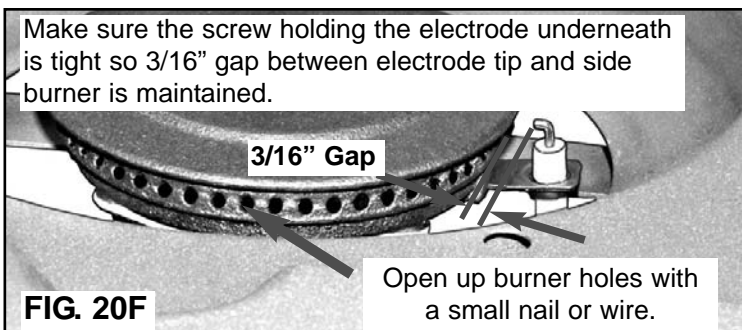
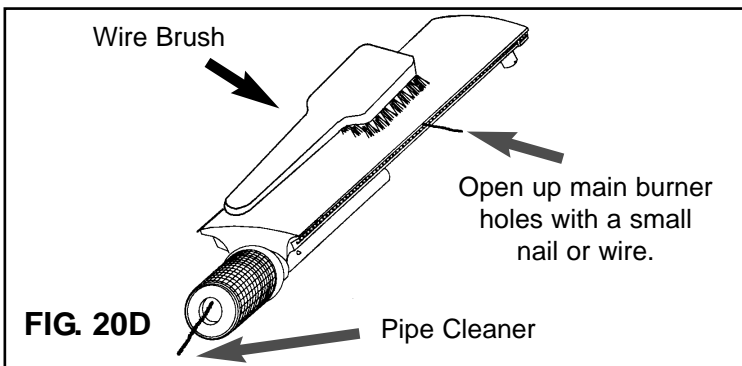
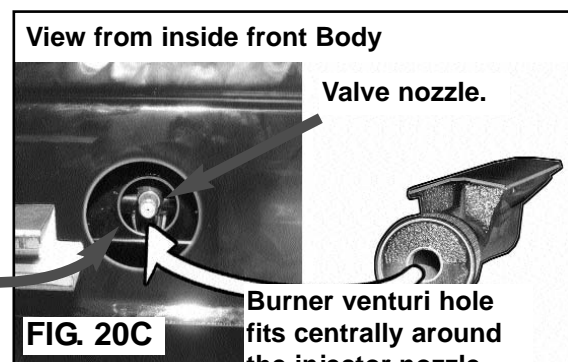
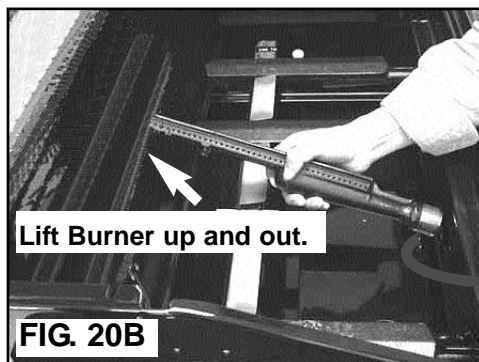

STORAGE

WARNING

To reduce the risk of serious bodily injury or death:

- Store your LP gas grill in a cool dry place. Do not store an LP gas cylinder in a space greater than 125 degrees Fahrenheit. Do not store an LP gas cylinder in a building ,garage or any enclosed area.
- Do not store an LP gas cylinder indoors (empty or filled). Disconnect the LP gas cylinder from the gas grill and store it outdoors out of the reach of children. The gas grill may then be stored indoors.
- To avoid an explosion, do not leave an LP gas cylinder inside a vehicle that can become overheated by the sun.
- Even though your LP gas cylinder may appear to be empty, gas may still be present and the cylinder should be transported and stored accordingly.
- Do not store a spare LP gas cylinder under or near the LP gas grill.
- Always turn off the gas cylinder at the LP cylinder valve when the gas grill is not in use.

- 1) Disconnect LP gas cylinder from grill and store outside, in a dry, well-ventilated area, away from any sources of heat or ignition. Re-cap LP cylinder valve with the Safety Cap.
- 2) Remove Burners and wrap with aluminum foil to prevent insects from entering the burner holes. Store wrapped Burners on top of cooking grid.
- 3) You may wrap the Cooking Grid and Flame Diffusers in aluminum foil and place inside the Hood or store inside your dwelling.
- 4) Place a grill cover over the grill and store the gas grill outdoors if possible. It may be stored indoors only if the cylinder or the the natural gas line is disconnected from the gas grill.
- 5) Before next use, remove aluminum foil and reinstall Burners, Flame Diffusers, ceramic briquette trays and Cooking Grids.
- 6) Before using the grill after periods of storage or non-use (i.e. over winter), check your LP gas grill for gas leaks, deterioration, proper assembly, and burner obstructions.
- 7) Periodically check and tighten all nuts, bolts, and screws.

TROUBLESHOOTING

| <u>Problem</u> | <u>Possible Cause</u> | <u>Solution</u> |
|--|--|---|
| Burners will not light using the ignitor | Burners not assembled correctly | See Burner Maintenance re-assembly after cleaning. |
| | Not holding ignitor switch long enough for pulse spark | When lighting the 1st (Leftmost) Burner, push control knob in and turn counter-clockwise to the "High" position. Pause 4 seconds, then depress the ignitor button rapidly for 4-5 seconds to light the burner. |
| | No spark | 1-Make sure all the wires are connected and to the right terminals. 2-Check the battery. Make sure it is pushed in the holder. 3-Gas collector tab is bent (making too large or small of a gap between electrode and tab). By hand, bend gas collector tab back within a maximum of 3/16" gap to electrode. (See page 16 for illustration). |
| | LP- gas cylinder is empty | Take LP gas cylinder to licensed LP gas supplier to be refilled. |
| | LP-Coupling nut is not fully connected to regulator | Tighten coupling nut by hand about one-half to three quarters additional turn. Do not use tools. |
| | LP-Excess flow valve tripped in regulator | Turn control knobs to "off" position and turn LP gas cylinder handle clockwise until it stops. Wait five minutes. Relight LP gas grill. |
| | Obstructions in burners | Clean burners (See Burner Maintenance in Cleaning and Maintenance section of this manual) |
| | Electrodes and burners are wet | Dry electrode with clean cloth. Air dry or use blow dryer. |
| | Wire loose or disconnected | Reconnect the wire. |
| | Wire shorting (sparking between ignitor and electrode | Replace ignitor wire/electrode assembly (Call the Customer Service Department). |

TROUBLESHOOTING (Cont'd)

| <u>Problem</u> | <u>Possible Cause</u> | <u>Solution</u> |
|--|--|---|
| Burners will not light using a match | Burners not assembled correctly | See Burner Maintenance re-assembly after cleaning. |
| | LP-gas cylinder is empty | Take LP gas cylinder to licensed LP gas supplier to be refilled |
| | LP-Excess flow valve tripped in regulator | Turn control knobs to “off” position and turn LP gas cylinder handle clockwise until it stops. Wait five minutes. Relight LP gas grill. |
| | LP-Coupling nut is not fully connected to regulator | Tighten coupling nut by hand about one-half to three quarters turn. Do not use tools. |
| | Obstructions in burners | See How to clean the Burners in Burner Maintenance . |
| Low flame or low heat | LP-Gas in LP cylinder is low | Check LP gas cylinder. Refill if necessary. |
| | Excess flow valve tripped in regulator | Turn control knobs to “off” position and turn LP gas cylinder handle clockwise until it stops. Wait five minutes. Relight LP gas grill. If flame continues to be low, turn off gas at cylinder and grill. Disconnect the regulator from the LP gas cylinder. Reconnect the regulator to the LP gas cylinder. Perform a leak test. Relight grill. This will reset the excess flow valve. |
| Flames blow out | High or gusting winds | Turn front of grill away from wind or increase flame height. |
| | Gas in LP cylinder is low | Check LP gas cylinder. Refill if necessary. |
| | Excess flow valve tripped | See “Low flame” problem above. |
| Flare up | Grease build up | Clean grill. |
| | Excessive fat in meat | Trim fat from meat before grilling. |
| Persistent grease fire | Grease trapped around burner system | Turn control knobs “off” and turn handle of LP cylinder clockwise until it stops. Open hood carefully and let fire burn out. After the grill cools, remove and clean all parts. |
| Unable to fill LP tank | Some dealers have older fill nozzles with worn threads. | The worn nozzles don’t have enough “bite” to engage the valve. Try another licensed LP dealer. |
| Humming or whistling from the regulator | Outside temperature, humidity, barometric pressure, and the gas level within the tank may cause the rubber diaphragm inside the regulator to vibrate, making a humming or whistling sound. | Although this sound may be alarming, this is NOT dangerous as long as it is not accompanied by the smell of gas. Simply adjust the burner settings and usually the sound will subside. If the humming sound persists, a change in atmospheric conditions will eventually stop the vibration. |
| Cabinet Doors Do Not Close | Door Magnets loose. | Tighten Door Magnet Bolts and Nuts. |
| | Doors not aligned. | Apply pressure to one side until doors are aligned. |

If your problem is not resolved from the information provided above, please call Customer Service at 1-800-251-7558.

IMPORTANT NOTICE

The Gas Grill is setup to operate with a LP Gas Cylinder equipped with an OPD (Overfill Prevention Device).

This is a secondary device to prevent the overfill of your LP Gas cylinder. The proper methods for the filling of your LP Gas cylinder are by weight or volume, as described in NFPA 58. Please make sure your filling station fills your LP Gas cylinder by weight or volume. Ask your filling station to read purging and filling instructions on the LP cylinder before attempting to fill.

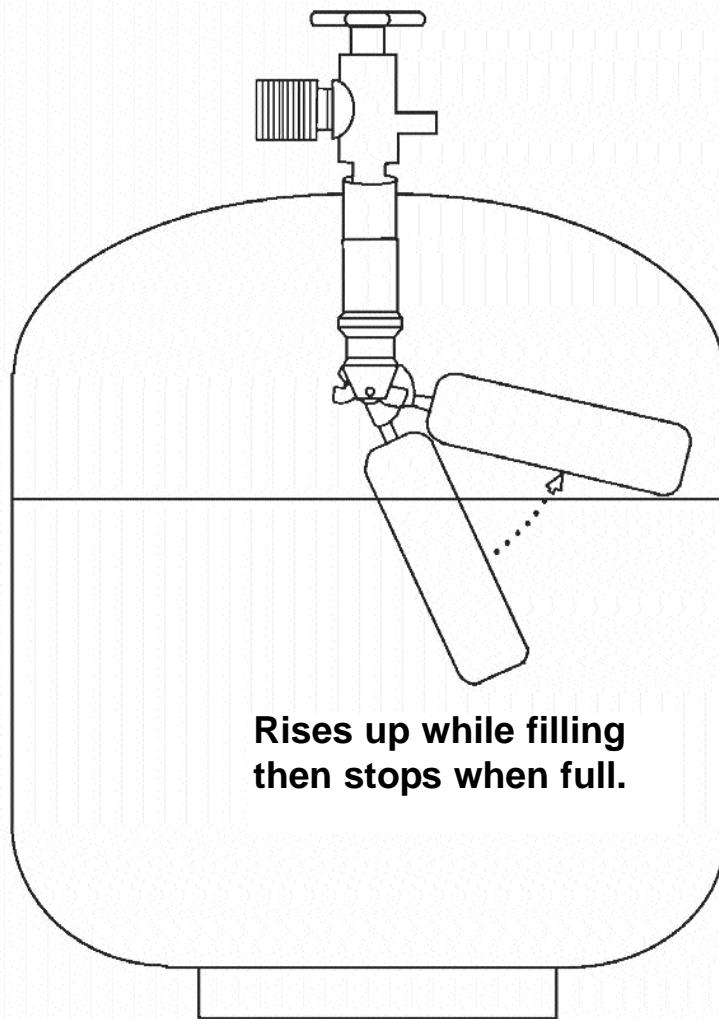

WARNING: Do not exchange the LP Gas cylinder unless the exchange LP cylinder is equipped with an OPD. Otherwise you will lose the OPD (Overfill Prevention Device) feature. If there is not an LP cylinder available for exchange equipped with an OPD, we recommend that you have your cylinder filled at an authorized LP gas dealer by a qualified attendant.

MECO CORPORATION
LIMITED WARRANTY

This product is warranted to the original consumer purchaser against defects in material and workmanship under normal outdoor household use and correct assembly (if assembled by the consumer purchaser). Burners are warranted for a period of five (5) years from the date of purchase. Type 304 Stainless steel parts are warranted for a period of (3) years (for rust-through only) from the date of purchase. All other Stainless steel parts are warranted for a period of one (1) year (for rust-through only) from the date of purchase. All other parts are warranted for a period of one (1) year from the date of purchase. MECO CORPORATION DOES NOT warrant in any way the propane cylinder (see label on cylinder for cylinder manufacturer's warranty.) The LP cylinder manufacturer is responsible for the materials, workmanship and performance of the cylinder. If the cylinder has a defect, malfunctions, or you have a question regarding the cylinder, call the cylinder manufacturer's customer service center. The phone number is on the cylinder. If the cylinder manufacturer has not resolved the issue to your satisfaction, then call MECO CORPORATION at the customer service number listed below.

MECO CORPORATION requires proof of purchase and we suggest you keep your receipt. Damages caused by commercial or institutional use, accidental or intentional damage, repairs made or attempted by unauthorized persons, or misuse are not covered by this warranty. If defective, the part or product will be repaired or replaced at the option of MECO CORPORATION without charge.

This warranty does not include the cost of any inconvenience or property damage due to failure of the product and does not cover damage due to misuse, abuse, accident, damage arising out of transportation of the product, damage incurred through commercial use, or failure to perform normal and routine maintenance. LIABILITY FOR CONSEQUENTIAL PROPERTY OR COMMERCIAL DAMAGES ARE EXPRESSLY EXCLUDED BY THIS WARRANTY. ANY APPLICABLE IMPLIED WARRANTIES OF MERCHANTABILITY AND FITNESS ARE LIMITED IN DURATION TO THE PERIOD COVERAGE OF THIS EXPRESS WRITTEN LIMITED WARRANTY. Some states do not allow limitation on how long an implied warranty lasts, so this limitation may not apply to you.

Deterioration or damage due to severe weather conditions such as hail, hurricanes, earthquakes or tornados, discoloration due to exposure to chemicals either directly or in the atmosphere, is not covered by this limited warranty.

No returns will be accepted without prior authorization from MECO CORPORATION. Authorization for return may be obtained by calling 1-800-251-7558. Handling and transportation costs for returning the product are not covered by this warranty and will be paid for by the purchaser. Please send your correspondence to:

MECO CORPORATION
Attn: Customer Service
1500 Industrial Road
Greeneville, TN 37745

For reference and correspondence,
record your Serial number here.
(See nameplate on side of grill.)

Serial No. _____
Please use this number in registering
your warranty and any correspondence
with MECO CORPORATION.