

Product Manual

Tandberg DLT8000



TANDBERG DATA 

Revision 1 - January 2001

TANDBERG DLT8000

PRODUCT MANUAL



TANDBERG DATA ASA
P.O. Box 134 Kjelsås
N-0411 OSLO, NORWAY
Phone + 47 22 18 90 90
Telefax + 47 22 18 95 50

© Tandberg Data ASA

Part No. 43 22 54-01
Publ. No. 9158-1
January 2001

This publication may describe designs for which patents are granted or pending. By publishing this information, Tandberg Data ASA conveys no license under any patent or any other rights.

Every effort has been made to avoid errors in text and diagrams. However, Tandberg Data ASA assumes no responsibility for any errors, which may appear in this publication.

It is the policy of Tandberg Data ASA to improve products as new techniques and components become available. Tandberg Data ASA therefore reserves the right to change specifications at any time.

We would appreciate any comments on this publication.

USER MANUAL STATEMENTS FOR CLASS A EQUIPMENT (INTERNAL TAPE SYSTEM)

This equipment generates, uses, and may emit radio frequency energy. The equipment has been type tested and found to comply with the limits for a Class A digital device pursuant to Part 15 of FCC rules, which are designed to provide reasonable protection against such radio frequency interference.

Operation of this equipment in a residential area may cause interference in which case the user at his own expense will be required to take whatever measures may be required to correct the interference.

Any modifications to this device - unless expressly approved by the manufacturer - can void the user's authority to operate this equipment under part 15 of the FCC rules.

NOTE:

Additional information on the need to interconnect the device with shielded (data) cables or the need for special devices, such as ferrite beads on cables, is required if such means of interference suppression was used in the qualification test for the device. This information will vary from device to device and needs to be obtained from the EMC group or product manager.

Warning!

This is a Class A product. In a domestic environment this product may cause radio interference in which case the user may be required to take adequate measures.

Achtung!

Dieses ist ein Gerät der Funkstörgrenzwertklasse A. In Wohnbereichen können bei Betrieb dieses Gerätes Rundfunkstörungen auftreten, in welchen Fällen der Benutzer für entsprechende Gegenmaßnahmen verantwortlich ist.

Warning!

**This Class A digital apparatus complies with Canadian ICES-003.
Cet appareil numérique de la classe A est conforme à la norme NMB-003 du Canada.**

Attention!

Ceci est un produit de Classe A. Dans un environnement domestique, ce produit risque de créer des interférences radioélectriques, il appartiendra alors à l'utilisateur de prendre les mesures spécifiques appropriées.

*User Manual Statements for Class A Equipment
(continued)*

警告使用者:

這是甲類的資訊產品，在居住的環境中使用時，可能會造成射頻干擾，在這種情況下，使用者會被要求採取某些適當的對策。

に基づくクラスA情報技術装置です。この装置を家庭環境で使用すると電波妨害を引き起こすことがあります。この場合には使用者が適切な対策を講ずるよう要求されることがあります。

USER MANUAL STATEMENTS FOR CLASS B EQUIPMENT (EXTERNAL TAPE SYSTEM)

This equipment has been tested and found to comply with the limits for a Class B digital device, pursuant to Part 15 of the FCC rules. These limits are designed to provide reasonable protection against harmful interference in a residential installation. Any modifications to this device - unless expressly approved by the manufacturer - can void the user's authority to operate this equipment under part 15 of the FCC rules. Operation is subject to the following two conditions: (1) This device may not cause harmful interference and (2) This device must accept any interference that may cause undesirable operation.

This equipment generates, uses, and can radiate radio frequency energy and, if not installed and used in accordance with the instructions, may cause harmful interference to radio communications. However, there is no guarantee that interference will not occur in a particular installation. If this equipment does cause harmful interference to radio or television reception, which can be determined by turning the equipment off and on, the user is encouraged to try to correct the interference by one or more of the following measures:

- Reorient or relocate the receiving antenna.
- Increase the separation between the equipment and receiver.
- Connect the equipment into an outlet on a circuit different from that to which the receiver is connected
- Consult the dealer or an experienced radio/TV technician for help.

NOTE:

Additional information on the need to interconnect the device with shielded (data) cables or the need for special devices, such as ferrite beads on cables, is required if such means of interference suppression was used in the qualification test for the device. This information will vary from device to device and needs to be obtained from the EMC group or product manager.

This Class B digital apparatus complies with Canadian ICES-003.

Cet appareil numérique de la classe B est conforme à la norme NMB-003 du Canada.

User Manual Statements for Class B Equipment (continued)

警告使用者:

這是甲類的資訊產品，在居住的環境中使用時，可能會造成射頻干擾，在這種情況下，使用者會被要求採取某些適當的對策。

この装置は、情報処理装置等電波障害自主規制協議会（VCCI）の基準に基づくクラスB情報技術装置です。この装置は、家庭環境で使用することを目的としていますが、この装置がラジオやテレビジョン受信機に近接して使用されると、受信障害を引き起こすことがあります。

取扱説明書に従って正しい取り扱いをして下さい。

Table of Contents

0.	About This Manual	0-1
0.1.	Audience	1
0.2.	Purpose	1
0.3.	Document Organization	1
0.4.	Conventions	3
1.	General Description and Specifications	1-1
1.1.	General Description	1
1.2.	Key Features	1
1.3.	Specifications	2
1.3.1.	Drive Capacity	2
1.3.2.	Interface Type	2
1.3.3.	Performance and Timing Specifications	3
1.3.4.	Reliability (Projected)	5
1.3.5.	Physical Specifications	5
1.3.6.	Temperature and Humidity	6
1.3.7.	Operating Air Velocity	7
1.3.8.	Vibration, Shock, and Drop Specifications	7
1.3.9.	Altitude	9
1.3.10.	Acoustic Emissions	10
1.3.11.	Electromagnetic Emissions	10
1.3.12.	Power Requirements	11
1.3.13.	Current Requirements	12
1.3.14.	Tape System Recording Type	13
1.3.15.	DLTape Recording Media Specifications	13
1.3.16.	Electromagnetic Interference (EMI) Susceptibility	15
2.	Configuring, Installing, and Operating the Tape System	2-1
2.1.	Safety, Handling, and Electrostatic Discharge (ESD) Protection	1
2.1.1.	Safety Precautions	1
2.1.2.	Handling	2
2.1.3.	Electrostatic Discharge (ESD) Protection	3
2.2.	Configuring and Installing an Integral Tape System	4
2.2.1.	Setting the SCSI ID	5
2.2.2.	Setting TERM PWR	7
2.2.3.	Setting Parity Checking	8
2.2.4.	Installing the Tape System	9
2.3.	Configuring and Installing a Tabletop Tape System	15
2.3.1.	Selecting SCSI ID	16
2.3.2.	Connecting the SCSI Bus Cables	17
2.3.3.	Installing the AC Power Cord	18
2.4.	The Tape Cartridge	21
2.4.1.	Care and Handling of Tape Cartridges	22

2.4.2.	<i>Tape Cartridge Write-Protect Switch</i>	24
2.4.3.	<i>Checking a Tape Cartridge</i>	26
2.4.4.	<i>Loading a Cartridge</i>	27
2.4.5.	<i>Unloading a Cartridge</i>	29
2.4.6.	<i>How and When to Use a Cleaning Tape Cartridge</i>	30
2.5.	<i>Operating the Tape System – Controls and Indicators</i>	32
2.5.1.	<i>Unload Button</i>	33
2.5.2.	<i>Cartridge Insert/Release Handle</i>	33
2.5.3.	<i>Selecting Density</i>	34
2.6.	<i>Power On Self Test (POST) and Indicator Activity During POST</i>	37
2.7.	<i>Tape System Operating Modes and Indicator Activity</i>	39
2.8.	<i>Using the DLT8000 Tape System's Basic Health Check (BHC) Test Feature</i>	42
2.9.	<i>Troubleshooting</i>	43
3.	SCSI Description	3-1
3.1.	<i>SCSI Overview</i>	1
3.2.	<i>SCSI Commands</i>	2
3.3.1.	<i>Signal Values</i>	5
3.3.2.	<i>SCSI ID Bits</i>	6
3.4.	<i>SCSI Signals</i>	7
3.4.1.	<i>SCSI Signal Definitions</i>	7
3.4.2.	<i>Signal Bus Timing</i>	8
3.5.	<i>SCSI Bus Phases</i>	11
3.5.1.	<i>BUS FREE Phase</i>	11
3.5.2.	<i>ARBITRATION Phase</i>	13
3.5.3.	<i>SELECTION Phase</i>	15
3.5.4.	<i>RESELECTION Phase</i>	17
3.5.5.	<i>Information Transfer Phases</i>	19
3.6.	<i>SCSI Bus Conditions</i>	28
3.6.1.	<i>Attention Condition</i>	28
3.6.2.	<i>Reset Condition</i>	30
3.6.3.	<i>Queued Unit Attentions</i>	31
4.	Messages	4-1
4.1.	<i>Message Format</i>	1
4.2.	<i>Supported SCSI Messages</i>	4
4.2.1.	<i>ABORT Message (06h)</i>	4
4.2.2.	<i>BUS DEVICE RESET Message (0Ch)</i>	4
4.2.3.	<i>COMMAND COMPLETE Message (00h)</i>	4
4.2.4.	<i>DISCONNECT Message (04h)</i>	5
4.2.5.	<i>IDENTIFY Message (80h - FFh)</i>	6
4.2.6.	<i>IGNORE WIDE RESIDUE Message (23h)</i>	7
4.2.7.	<i>INITIATOR DETECTED ERROR Message (05h)</i>	8
4.2.8.	<i>LINKED COMMAND COMPLETE Message (0Ah)</i>	9
4.2.9.	<i>LINKED COMMAND COMPLETE, with Flag Message (0Bh)</i>	9

4.2.10.	MESSAGE PARITY ERROR Message (09h)	9
4.2.11.	MESSAGE REJECT Message (07h)	9
4.2.12.	NO OPERATION (08h)	10
4.2.13.	RESTORE POINTERS Message (03h)	10
4.2.14.	SAVE DATA POINTER Message (02h)	10
4.2.15.	SYNCHRONOUS DATA TRANSFER REQUEST Message (01h)	11
4.2.16.	WIDE DATA TRANSFER REQUEST Message (03h)	12
5.	SCSI Commands	5-1
5.1.	SCSI COMMANDS	1
5.1.1.	SCSI Pointers	3
5.1.2.	Command Descriptor Block	4
5.1.3.	Status/Error Reporting	7
5.1.4.	DATA-Phase Command Components	8
5.1.5.	Unit Attention Condition	11
5.1.6.	Behavior At Power-On and SCSI Bus Reset	12
5.1.7.	Data Cache and Tape Write Interaction	13
5.2.	SCSI-command Descriptions in This Manual	14
5.3.	ERASE Command (19h)	16
5.4.	INQUIRY Command (12h)	18
5.4.1.	Standard Inquiry Data Page	19
5.4.2.	Vendor Unique Inquiry Data	23
5.4.3.	Supported Vital Product Data Pages and Command Support Data	25
5.5.	LOAD UNLOAD Command (1Bh)	33
5.6.	LOCATE Command (2Bh)	36
5.7.	LOG SELECT Command (4Ch)	38
5.7.1.	Log Detection Summary in LOG SELECT Command Descriptor Block	40
5.7.2.	Operation of LOG SELECT	40
5.7.3.	Log Select Page Format	41
5.7.4.	Error Detection Summary in Log Select Pages	45
5.8.	LOG SENSE Command (4Dh)	46
5.8.1.	Error Detection Summary in LOG SENSE Command Descriptor Block	49
5.8.2.	Supported Pages Log Page (Page 00h)	50
5.8.3.	READ (Page 03h) / WRITE (Page 02h) ERROR LOG SENSE Page	51
5.8.4.	LAST n ERROR EVENTS Page (07h)	55
5.8.5.	TapeAlert Page (2Eh)	57
5.8.6.	READ / WRITE COMPRESSION Page (32h)	61
5.8.7.	Device Wellness Page (33h)	65
5.8.8.	Device Status Page (3Eh)	68
5.9.	MODE SELECT Command (6) / (10) (15h / 55h)	72
5.9.1.	Mode Parameter List	74

5.9.2.	READ / WRITE ERROR RECOVERY PAGE (01h)	81
5.9.3.	DISCONNECT / RECONNECT PAGE (02h)	83
5.9.4.	CONTROL MODE PAGE (0Ah)	85
5.9.5.	DATA COMPRESSION PAGE (0Fh)	87
5.9.6.	DEVICE CONFIGURATION PAGE (10h)	89
5.9.7.	MEDIUM PARTITION PAGE (11h)	92
5.9.8.	TAPEALERT PAGE (1Ch)	94
5.9.9.	EEPROM VENDOR UNIQUE PAGE (3Eh)	97
5.9.10.	Changeable Parameters within MODE SELECT	105
5.10.	MODE SENSE (6) / (10) Command (1Ah / 5Ah)	106
5.10.1.	MODE SENSE Data Headers	109
5.10.2.	MODE SENSE Block Descriptor	112
5.10.3.	MODE SENSE Mode Pages	115
5.11.	PERSISTENT RESERVATION IN Command (5Eh)	134
5.12.	PERSISTENT RESERVATION OUT Command (5Fh)	146
5.13.	PREVENT / ALLOW MEDIUM REMOVAL Command (1Eh)	160
5.14.	READ Command (08h)	161
5.15.	READ BLOCK LIMITS Command (05h)	164
5.16.	READ BUFFER Command (3Ch)	166
5.16.1.	Combined Header and Data Mode	168
5.16.2.	Data Mode	169
5.16.3.	Descriptor Mode	169
5.17.	READ POSITION Command (34h)	170
5.17.1.	Standard READ POSITION Data	171
5.17.2.	Total Current Logical Position	173
5.18.	RECEIVE DIAGNOSTIC RESULTS Command (1Ch)	174
5.19.	RELEASE UNIT (6) Command (17h)	176
5.20.	RELEASE UNIT (10) Command (57h)	178
5.21.	REPORT DENSITY SUPPORT Command (44h)	180
5.22.	REPORT LUNS Command (A0h)	186
5.23.	REQUEST SENSE Command (03h)	188
5.24.	RESERVE UNIT (6) Command (16h)	202
5.25.	RESERVE UNIT (10) Command (56h)	205
5.26.	REWIND Command (01h)	210
5.27.	SEND DIAGNOSTIC Command (1Dh)	211
5.28.	SPACE Command (11h)	217
5.29.	TEST UNIT READY Command (00h)	219
5.30.	VERIFY Command (13h)	220
5.31.	WRITE Command (0Ah)	221
5.32.	WRITE BUFFER Command (3Bh)	224
5.32.1	Write Combined Header and Data Mode (000b)	225
5.32.2	Write Data Mode (010b)	225
5.32.3	Download Microcode Mode (100b)	225
5.32.4.	Download Microcode and Save Mode (101b)	226
5.33.	WRITE FILEMARKS Command (10h)	227

A.	Definition of Vendor Unique Sense Data Information	A-1
B.	EEPROM-resident Bugcheck and Event Logs	B-1
B.1.	EEPROM Packets (LAST n EVENTS)	1
B.2.	Bugcheck Packets	2
B.2.1.	POST Failure Packets	3
B.2.2.	Event Log Packets	3
C.	Updating the Firmware	C-1
C.1.	Overview	1
C.2.	Creating a Firmware Update Tape	1
C.3.	Firmware Update Procedure	2
C.4.	Interpreting the Results of a Firmware Update	4
D.	Running the Basic Health Check (BHC) Test via the Library Port	D-1
E.	Visual Inspection Procedure for DLTtape Cartridges	E-1
F.	Timeout Specifications for DLT8000 Tape System SCSI Commands	F-1
G.	DLT7000 Emulation Feature	G-1
G.1.	Enabling and Clearing the DLT7000 Emulation Feature	2
G.2.	What You Should Know About the DLT7000 Emulation Feature	3
G.3.	Verifying Product Family via the SCSI Bus	4
G.4.	SCSI Bus Differences	5
G.5.	Front Panel Differences	7

This Page Intentionally Left Blank

0. *About This Manual*

“About this Manual” outlines the scope and contents of this manual. It contains information about the intended audience, purpose of the manual, document organization, and document conventions.

0.1. Audience

This manual is written for original equipment manufacturers (OEMs) that are integrating this Tandberg DLT8000 system into a host system or subsystem. Its primary audience is the OEM technical staff that makes tape system purchase and configuration decisions, and system integrators that are responsible for the SCSI interface. Additionally, the manual can be used by technically astute end-users for installation and operation of the tape system, although that is a secondary audience.

0.2. Purpose

This manual describes the Tandberg DLT8000 Tape System. It is intended to provide the information necessary to integrate the tape system into a computer system or subsystem.

0.3. Document Organization

This product manual contains five chapters, a number of appendixes of related useful information, and an index. It includes an overview of the Small Computer System Interface (SCSI) and detailed descriptions of the messages and SCSI commands as used by the tape system. The manual is organized as follows:

Chapter 1: General Description and Specifications

This chapter contains a brief description of and specifications for the system.

Chapter 2: Configuration and Installation

This chapter contains information on system hardware and system interfaces.

Chapter 3: SCSI Description

This chapter provides a detailed description of the logical interfaces of the tape system. It describes the product's compliance with the ANSI SCSI-2 specification. The system's many optional features are described here and throughout the manual.

Chapter 4: SCSI Messages

This chapter provides a list and description of most messages supported by the tape system. The SCSI message system allows communication between SCSI initiators and SCSI targets (the tape system, in this case) for interface management and for command elaboration and qualification.

Chapter 5: SCSI Commands

This chapter describes in detail each command supported by the tape system. The SCSI command system enables an initiator to direct a tape system to perform a wide range of operational and diagnostic functions.

Appendix A Definition of Vendor Unique Sense Data Information

Appendix A provides a list of internal status codes related to the REQUEST SENSE SCSI command.

Appendix B Sense Key Information

Appendix B provides a list of tape system additional sense codes, additional sense code qualifiers, and their meanings.

Appendix C EEPROM-Resident Bugcheck and Event Logs

Appendix C provides an explanation of the event logs stored in semi-permanent, non-volatile memory.

Appendix D Updating the Firmware

Appendix D provides a step-by-step procedure for updating a tape system's PCBA controller-resident firmware.

Appendix E Running the Basic Health Check (BHC) Test Via the Library Port

Appendix E explains how a trained service provider can run the DLT8000 tape system's BHC test on a tape drive that is configured as a component within a library.

Appendix F Visual Inspection Procedure for DLTtape Cartridges

Appendix F explains how to visually inspect a DLTtape cartridge. Damaged tape cartridges must not be used.

0.4. Conventions

This manual uses the following conventions to designate specific elements:

Element	Convention	Example
Commands	Uppercase (unless case-sensitive)	FORMAT UNIT
Messages	Uppercase	INVALID PRODUCT NUMBER
Hexadecimal Notation	Number followed by lowercase <i>h</i>	25h
Binary Notation	Number followed by lowercase <i>b</i>	101b
Decimal Notation	Number without suffix	512
Acronyms	Uppercase	POST
Abbreviations	Lowercase, except where standard usage requires uppercase	Mb (megabits) MB (megabytes)

This Page Intentionally Left Blank

1. General Description and Specifications

This chapter provides a description and gives specifications for the Tandberg DLT8000 Tape System.

1.1. General Description

The Tandberg DLT8000 tape system is a high-performance, high-capacity, streaming cartridge tape product designed for efficient data back-up for midrange and high-end computing systems. With Tandberg Data's DLT advanced linear recording technology, a highly accurate tape guide system, and an adaptive control mechanism, the system is ideally suited for mid-range systems, network servers, and high-end workstations and systems.

Using data compression and compaction, the DLT8000 tape system features a formatted capacity of 80.0 GB* and a sustained user data transfer rate of up to 12 MB/second* (native capacity is 40.0 GB; native data transfer rate is 6.0 MB/second).

The device is an extended-length, 5.25 inch form factor, half-inch tape system. The design includes a four channel read/write head, Lempel-Ziv (LZ) high-efficiency data compression, and tape mark directory to maximize data throughput and minimize data access time.

The tape system is available either as an integrated or "embedded" drive or as a tabletop version. The tabletop version is packaged in a housing and includes its own cooling fan and power supply, requiring ac power.

1.2. Key Features

- 40.0 GB Native, 80.0 GB Compressed* Capacity
- Superior Error Detection and Correction
- Extensive Embedded Diagnostic/Self-Test Software
- Dual Speed Recording
- Fast access to Data via Tape Mark Directory
- Tape-Loadable Firmware

* Actual transfer rate and capacity will vary depending on data.

1.3. Specifications

This section of Chapter 1 provides the performance, physical, environmental, and electrical specifications for the tape system. Specifications for the DLTtape™ tape media cartridges are included.

1.3.1. Drive Capacity

Table 1–1 provides the ranges of capacity (native and compressed) for the tape system, depending on which DLTtape cartridge is used.

DLTtape Cartridge (Length of Medium)	Storage Capacity (Native)	Storage Capacity (Compressed)
DLTtape IV (1800 foot tape)	40.0 GB User Data	80.0 GB User Data*
DLTtape IIIXT (1800 foot tape)	15.0 GB User Data	30.0 GB User Data*
DLTtape III (1200 foot tape)	10.0 GB User Data	20.0 GB User Data*

**Actual capacity will vary depending on data.*

Table 1–1 Storage Capacity

1.3.2. Interface Type

Two interfaces are available: Low Voltage Differential (LVD)/Single-Ended and High Voltage Differential (HVD) SCSI-2.

1.3.3. Performance and Timing Specifications

Table 1–2 provides performance and timing specifications for the tape system.

Item	Specification
Transfer Rates	User Native = 6.0 MB/second Compressed = Up to 12.0 MB/second *
Error Rates	Recoverable READ Error Rate = 1 in 10^6 bits read Unrecoverable READ Error Rate = 1 in 10^{17} bits read ** Undetected READ Error Rate = 1 in 10^{27} bits read
Tracks	208 physical (52 quad logical tracks on media); drive has 4 parallel physical (1 logical) tracks written or read simultaneously
Linear Bit Density	98,250 bpi per track
READ / WRITE Tape Speed	168 inches/second
Rewind Tape Speed	175 inches/second
Linear Search Tape Speed	175 inches/second
Average Rewind Time	60 seconds

* = Depending on data type and SCSI bus limitations/system configuration

** = An unrecoverable error is any READ error that cannot be recovered using the drive's internal error recovery algorithms or, if the drive indicates "Cleaning Required", by removing the data cartridge, performing a cleaning operation, and attempting to re-read the data from the data cartridge.

Table 1–2 Performance and Timing Specifications

Item	Specification		
READ/WRITE Tape Speed	168 inches/second		
Linear Search Tape Speed	175 inches/second		
Rewind Tape Speed	175 inches/second		
Average Rewind Time	60 seconds		
Maximum Rewind Time	120 seconds		
	Minimum	Average	Maximum
Access Time From BOT (32KB blocks) in seconds	2	69	136
Save Set Access Times (25 Mb Save Set) in seconds	6	70	134
LOAD Time to BOT (Formatted tape)	Average 130 seconds (steady state)		
LOAD Time to BOT (Unformatted tape) in seconds	Average 133 seconds (steady state)		
UNLOAD Time From BOT	Average 21 seconds		

Table 1-2 Performance and Timing Specifications (continued)

1.3.4. Reliability (Projected)

Mean time between failures (MTBF) for the tape system is projected to be 250,000 hours at 100% duty cycle, not including heads; 300,000 hours at 20% duty cycle, not including heads. Life of recording heads is 30,000 hours, minimum; 50,000 hours, average.

Media durability is projected to be 1,000,000 passes of the tape medium across the read/write heads (15,000 uses). One tape pass is defined as any point on the tape passing the head in either direction.

Tandberg Data does not warrant that predicted MTBF is representative of any particular unit installed for customer use. Actual figures vary from unit to unit.

1.3.5. Physical Specifications

Table 1–3 provides the key physical specifications for the integratable and tabletop versions of the tape system.

Description	Integratable Version	Tabletop Version
Height	3.25 in. (82.5 mm) without front bezel; 3.4 in (86.3 mm) with front bezel.	6.48 in. (164.592 mm)
Width	5.735 in. \pm .045 in. (144.8 mm \pm 1.143 mm) behind front bezel; 5.87 in (149.0 mm) with front bezel.	6.88 in. (174.752 mm)
Length	9.00 in. (228.6 mm) measured from back of front bezel; 9.60 in. (243.8 mm) including front bezel	12.8 in. (325.12 mm) (includes the Tape Eject Handle protruding 0.2 inches [5.08 mm])
Weight	6 lb, 7 oz (2.9 kg)	14 lbs (6.35 kg)

Table 1–3 Physical Dimensions

1.3.6. Temperature and Humidity

Table 1–4 provides the temperature and humidity specifications for the tape system.

Description	Integratable Version	Tabletop Version
Operating Ranges		
Temperature Range	50°F to 104°F (10°C to 40°C)	50°F to 104°F (10°C to 40°C)
Temperature Gradient	18°F (10°C) per hour (across the range)	18°F (10°C) per hour (across the range)
Dry Bulb Temp. Range	50°F to 104°F (10°C to 40°C)	50°F to 104°F (10°C to 40°C)
Wet Bulb Temperature	77°F (25°C)	77°F (25°C)
Relative Humidity	20% to 80%, non-condensing	20% to 80%, non-condensing
Humidity Gradient	10% / hour	10% / hour
Storage Ranges (Unpacked or Packed)		
Temperature Gradient	36°F (20°C) per hour with 5° margin (across the range)	36°F (20°C) per hour with 5° margin (across the range)
Dry Bulb Temp. Range	-40°F to 150.8°F (-40°C to 66°C)	-40°F to 150.8°F (-40°C to 66°C)
Wet Bulb Temperature	114.8°F (46°C)	114.8°F (46°C)
Relative Humidity	5% to 95%, non-condensing	5% to 95%, non-condensing
Humidity Gradient	10% / hour	10% / hour
Shipping Ranges		
Temperature Gradient	36°F (20°C) per hour with 5° margin (across the range)	36°F (20°C) per hour with 5° margin (across the range)
Dry Bulb Temp. Range	-40°F to 150.8°F (-40°C to 66°C)	-40°F to 150.8°F (-40°C to 66°C)
Wet Bulb Temperature	114.8°F (46°C)	114.8°F (46°C)
Relative Humidity	10% to 95%, non-condensing	10% to 95%, non-condensing
Humidity Gradient	10% / hour	10% / hour

Table 1–4 Temperature and Humidity Specifications

1.3.7. Operating Air Velocity

Both versions of the tape system require an air flow velocity of 125 linear feet per minute measured directly in front of the bezel.

1.3.8. Vibration, Shock, and Drop Specifications

Table 1–5 provides the vibration and shock specifications for operating tape systems, and for non-operating tape systems (both packaged and unpackaged). Table 1-6 provides the drop specifications for the tape system.

Operating Vibration Specifications		
Vibration Type	Sine	Sweep
Frequency Range	5 – 500 – 5 Hz	Upward and downward sweep
Acceleration Level	0.25 G 0.010" DA	Between 22 and 500 Hz Between 5 and 22 Hz (crossover)
Application	X, Y, and Z axes	Sweep rate: 1 octave per minute
Operating Shock Specifications		
Pulse Shape	½ sine pulse	
Peak Acceleration	10 G	
Duration	10 ms	
Application	X, Y, and Z axes; once in each axis	
Non-Operating (Packaged) Vibration Specifications		
Vibration Type	Random Vibration	
Frequency Range	5 to 300 Hz, Vertical Axis (Z); 5 to 200 Hz, Horizontal Axes (X and Y)	
Vibration Levels	1.0 GRMS overall in X, Y, and Z axes	
Application	X, Y, and Z axes (one hour, each axis; 3 hour total)	

Table 1–5 Vibration and Shock Specifications (continued)

Non-Operating (Unpackaged) Vibration Specifications

Vibration Type:	Sine	Sweep
Frequency Range	5 – 500 – 5 Hz	Upward and downward sweep
Acceleration Level	1 G	5 – 500 – 5 Hz
Application	X, Y, and Z axes 0.010 inch DA	Sweep rate: 1 octave per minute Between 5 – 31 Hz (crossover)
Vibration Type:	Random	
Frequency Range	10 – 500 Hz	
Acceleration Level	2 g	
PSD Envelope	0.008 g ² /Hz	
Application	X, Y, and Z axes	60 minutes/axis

Non-Operating (Packaged) Repetitive Shock Specifications

Excitation Type	Synchronous vertical motion; 1 inch excursion
Shock (Bounce) Cycles	14,200 total
Application	Half cycles each in X and Y orientations; ½ 7100 impacts in the shipping orientation, 3500 impacts in the remaining two axes.

Non-Operating (Unpackaged) Shock Specifications

Pulse Shape: Square wave	
Peak Acceleration	40 G
Duration	10ms/180 inches/second
Application	X, Y, and Z axes, twice in each axis (once each direction)
Pulse Shape: ½ sine pulse	
Peak Acceleration	140 G
Duration	2 ms
Application	X, Y, and Z axes, twice in each axis (once each direction)

Table 1–5 Vibration and Shock Specifications (continued)

Non-Operating (Packaged) Drop Specifications

Test Type: Drop Shock	Drop Height: 30 inches for items < 20.9 lbs (9.48 kg) 23 inches for items between 21lbs (9.52 kg) and 40.9 lbs. (18.55 kg)
Application	10 drops total; 1 each side, 3 edges, 1 corner

Table 1–6 Drop Specifications

1.3.9. Altitude

The following table provide the tape system’s altitude specifications, both operating and non-operating.

Operating & Non-Operating Altitude Specifications

- 500 ft (-152 m) to 40,000 ft (12192 m) at ambient temperature of 77°F (25°C)

Table 1–7 Altitude Specifications

1.3.10. Acoustic Emissions

The following tables provide the tape system's acoustic noise emission levels, both as noise power and sound pressure. Information about acoustic emissions is also provided in German to fulfill an international requirement.

Noise Power Emission Level (LNPEc)		
Mode	Integratable Version	Tabletop Version
Idle	Not applicable	5.4 Bel
Streaming	5.9 Bel	5.9 Bel

Sound Pressure Level (LPAc)		
Mode	Integratable Version	Tabletop Version
Idle	Not applicable	40 dB
Streaming	47 dB	44 dB

Table 1–8 Acoustic Noise Emissions, Nominal

Schallemissionswerte – Werteangaben nach ISO 9296 und ISO 7779/DIN EN27779:				
Gerät	Schalleistungspegel LwAD, B		Schalldruckpegel LpAm, dBA (Zuschauerpositionen)	
	Leerlauf	Betrieb	Leerlauf	Betrieb
THxxx *		5,9		47
THxBx *	5,4	5,9	40	44

- = THxxx is the integratable version of the tape system; THxBx is the tabletop version.

Table 1–9 Acoustic Noise Declaration for German Noise Declaration Law

1.3.11. Electromagnetic Emissions

The tabletop version complies with FCC Class B limits.

1.3.12. Power Requirements

Table 1–10 provides the applicable power requirements for both versions of the tape system. Note that the tabletop version requires ac power.

Description		Integratable Version	Tabletop Version
Electrical Rating Ranging)	(Auto	Not applicable	100 to 240 VAC
Power Requirements		28 W, steady state	56 W, maximum
Power Consumption:			
+5 V ($\pm 5\%$) bus *		2.8 A, steady state; 4.35 A, maximum	Not Applicable
+12 V ($\pm 5\%$) bus *		1.2 A, steady state; 4.5 A, maximum	Not Applicable

Table 1–10 Power Requirements

* = Voltage measured at the power bus connector pins.

1.3.13. Current Requirements

Table 1-11 presents the current requirements for the tape system in a variety of operating conditions. These numbers may vary with workload.

Drive Operating in WRITE Mode Start/Stop		
	Typical	Maximum (Includes Ripple)
5 Volt	2.2	3.9
12 Volt	1.2	3.6
Drive Operating in Calibration		
	Typical	Maximum (Includes Ripple)
5 Volt	2.1	3.3
12 Volt	1.2	4.5
Drive Tensioned, but Tape Not in Motion (Standby Mode)		
	Typical	Maximum (Includes Ripple)
5 Volt	2.2	2.7
12 Volt	0.6	1.0
Drive Unloaded with Cartridge Door Opened		
	Typical	Maximum (Includes Ripple)
5 Volt	2.1	2.6
12 Volt	0.6	1.1
Drive Rewinding to BOT		
	Typical	Maximum (Includes Ripple)
5 Volt	2.3	3.6
12 Volt	0.8	3.0
Drive Operating in Stream WRITE/READ Mode		
	Typical	Maximum (Includes Ripple)
5 Volt	3.1	4.3
12 Volt	1.0	3.6

Table 1-11 Current Requirements

1.3.14. **Tape System Recording Type**

The tape system uses 2,7 RLL code with DLTTM 2000, DLTTM 2000XT, DLTTM 4000, DLTTM 7000, or DLT8000 format.

1.3.15. **DLTtape Recording Media Specifications**

Table 1–12 provides specifications for tape media. Table 1-12 provides operating and storage environment limits for the tape cartridges

DLTtape Media Type	Specifications	
DLTtape III	Width:	0.5 inch
	Length:	1200 feet
	Cartridge Dimensions:	4.1 in x 4.1 in x 1.0 in
	Shelf Life:	20 years min. @ 20°C & 40% RH (non-condensing)
	Usage:	500,000 passes
DLTtape IIIXT	Width:	0.5 inch
	Length:	1800 feet
	Cartridge Dimensions:	4.1 in x 4.1 in x 1.0 in
	Shelf Life:	30 years min. @ 20°C & 40% RH (non-condensing)
	Usage:	500,000 passes

Table 1–12 DLTtape Media Specifications

DLTtape Media Type	Specifications	
DLTtape IV	Width:	0.5 inch
	Length:	1800 feet
	Cartridge Dimensions:	4.1 in x 4.1 in x 1.0 in
	Shelf Life:	30 years min. @ 20°C & 40% RH (non-condensing)
	Usage:	1,000,000 passes

Table 1–12 DLTtape Media Specifications (continued)

Operating Conditions:		
Temperature	50° to 104°F (10° to 40°C)	
Relative Humidity	20% to 80% non-condensing	

Storage Conditions:	With Data:	Without Data:
Temperature	64° to 79°F (18° to 26°C)	61° to 89°F (16° to 32°C)
Relative Humidity	40% to 60% non-condensing	20% to 80% non-condensing

Table 1–13 DLTtape Cartridge Operating and Storage Limits

1.3.16. **Electromagnetic Interference (EMI) Susceptibility**

This section presents tables that provide the specifications for conducted emissions, radiated emissions, magnetic radiated susceptibility, radiated susceptibility, conducted susceptibility, and ESD failure limits.

Regulations and certifications for the tape system include:

For electromagnetic emissions:

- CSA 108.8
- EEC Directive 89/336

EN55022 and national standards are based on:

- BS6527 (UK)
- NEN55022 (Netherlands)
- VDE 0971 Class B (Germany)
- CE Mark

Cispr22 Class B:

- FCC Rules Part 15B
- Class B Certification

NOTE:

Limits for Class B equipment are in the frequency range from 0.15 to 30 MHz. The limit decreases linearly, with the logarithm of the frequency in the range from 0.15 to 0.50 MHz.

Frequency Range (MHz)	Limits (dB)	
	Quasi-Peak	Average
0.15 to 0.05	66 to 56*	56 to 46
0.50 to 5	56	46
5 to 30	60	50

* The limit decreases with the logarithm of the frequency.

Table 1–14 Conducted Emissions

NOTE:

Table 1-15 shows the Class B equipment limits for radiated interference field strength in the frequency range from 30 MHz to 30 GHz at a test distance of 3 and 10 meters.

Frequency Range (MHz)	Quasi-Peak Limit dB ($\mu\text{V/m}$)	
	@ 3 Meters	@ 10 Meters
30 to 230	40	30
230 to 1000	46	37
Above 1000	54	N/A

Table 1-15 Radiated Emissions

Low Frequency, Magnetic Fields, 10 to 3000 kHz	
100 dB (pt) @ 10 kHz Declining to 80 dB (pt) @ 1 MHz	No errors, no screen distortion

Table 1-16 Magnetic Radiated Susceptibility

High Frequency, Electric Fields, 1 to 1000 MHz	
3 V/m (rms) 80% modulated 1 kHz	No errors, no screen distortion
	S/W recoverable errors
	No hardware failure

Table 1-17 Radiated Susceptibility

NOTE

The transient voltage is the actual peak voltage above the normal ac voltage from the power source.

Fast Transient (Bursts) for Power and Data Cables

2 kV	S/W recoverable errors No hardware failures
------	--

High Energy Transient Voltage for Power Cables *

1.2 kV	No errors
2.5 kV	S/W recoverable errors No hardware failures

Low-Level Conducted Interference

3 V (rms) 80% modulated kHz	1	No errors S/W recoverable errors No hardware failures
--------------------------------	---	---

Fast Transient (Bursts) for Power and Data Cables

2 kV	S/W Recoverable errors No hardware failures
------	--

Table 1–18 Conducted Susceptibility

Failure Type	Equipment	Failure Level	Allowable Errors
Hard	Office	1 to 12 kV	No Operator Intervention (soft recoverable allowed)
Hardware	Office	Up to 15 kV	No component damage – operator intervention allowed (soft/hard errors allowed)

Table 1–19 ESD Failure Level Limits

This Page Intentionally Left Blank

2. **Configuring, Installing, and Operating the Tape System**

This chapter contains information needed for the integration of the tape system into a system or subsystem. This includes safety and handling instructions, configuration jumper settings, connector pin assignments, installation instructions, power and signal cabling descriptions, and operating instructions.

2.1. **Safety, Handling, and Electrostatic Discharge (ESD) Protection**

Inappropriate or careless handling of tape systems may result in damage to the product. Follow the precautions and directions to prevent damaging the tape system.

2.1.1. **Safety Precautions**

For your safety, follow all safety procedures described here and in other sections of the manual.

- Remove power from the computer system (or expansion unit) before installing or removing the tape system to prevent the possibility of electrical shock or damage to the tape system. Unplug the unit that contains or is to contain the system from ac power to provide an added measure of safety.
- Read, understand, and observe any and all label warnings.

2.1.2. Handling

Damage to the system can occur as the result of careless handling, vibration, shock, or electrostatic discharge (ESD). Always handle the tape system with care to avoid damage to the precision internal components.

Follow these guidelines to avoid damage to the system:

- Always observe prescribed ESD precautions.
- Keep the system in its anti-static bag until ready to install.
- Always use a properly fitted wrist strap or other suitable ESD protection when handling the system.
- Hold system only by its sides. Do not touch any components on the PCBA.
- Always handle the system carefully and gently. A drop of 1/4 inch onto a bench or desktop may damage a system.
- Do not bump, jar, or drop the system. Use care when transporting the system.
- Never place the tape system so that it rests on its front bezel. Always gently place the system flat, PCB side down, on an appropriate ESD-protected work surface to avoid the system being accidentally knocked over.
- Do not pack other materials with the system in its shielded bag.
- Place the system in the anti-static bag before placing in shipping container.
- Do not stack objects on the system.
- Do not expose the system to moisture.
- Do not place hands or foreign objects inside the tape system's door/receiver area.
- Do not touch the tape leader, cartridge leader, or tape media. Body oils will damage the media and recording heads.

2.1.3. *Electrostatic Discharge (ESD) Protection*

Various electrical components on/within the tape system are sensitive to static electricity and Electrostatic Discharge (ESD). Even a static buildup or discharge that is too slight to feel can be sufficient to destroy or degrade a component's operation.

To minimize the possibility of ESD-related damage to the system, we strongly recommend using both a properly installed workstation anti-static mat and a properly installed ESD wrist strap. When correctly installed, these devices reduce the buildup of static electricity which might harm the system.

Observe the following precautions to avoid ESD-related problems:

- Use a properly installed anti-static pad on your work surface.
- Always use a properly fitted and grounded wrist strap or other suitable ESD protection when handling the system and observe proper ESD grounding techniques.
- Hold the system only by its sides. Do not touch any components on the PCBA.
- Leave the system in its anti-static bag until you are ready to install it in the system.
- Place the system on a properly grounded anti-static work surface pad when it is out of its protective anti-static bag.
- Do not use the bag as a substitute for the work surface anti-static pad. The outside of the bag may not have the same anti-static properties as the inside. It could actually increase the possibility of ESD problems.
- Do not use any test equipment to check components on the PCBA. There are no user-serviceable components on the system.

2.2. Configuring and Installing an Integral Tape System

This section provides information for configuring and installing a tape system that is integrated into a host system, expansion cabinet, or other chassis. For information for configuring and installing a tabletop tape system, see Section 2.3.

WARNING

Before you begin, review the Safety, ESD, and Handling precautions described at the beginning of this chapter to avoid personal injury or damage to equipment.

This section contains information about configuring (“tailoring”) the tape system via the system’s jumper settings. Settings are included for the following options:

Option	See Section....
SCSI ID Selection and Disabling Parity Checking	2.2.1
TERM PWR Setting	2.2.2
Parity Checking Setting	2.2.3

2.2.1. Setting the SCSI ID

Select the appropriate SCSI ID (IDs 0 through 15 are available) for the tape system by installing jumper blocks on the pin pairs of the connector block located on the tape system's PCBA (Figure 2-1). Refer to Table 2-1 for the allowable SCSI IDs.

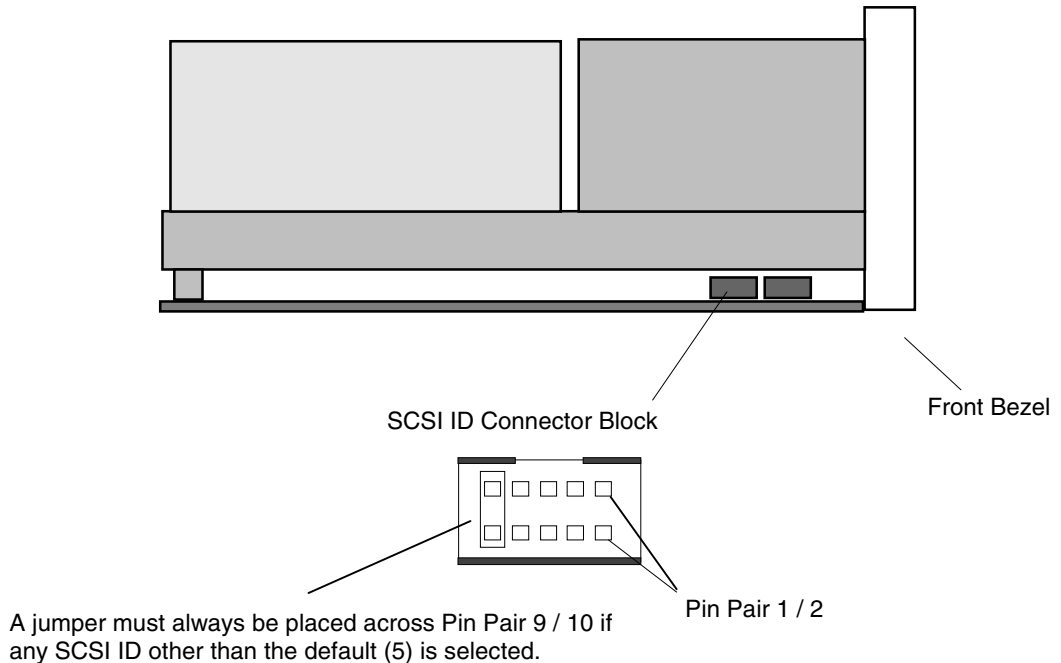

Figure 2-1 Location of SCSI ID Connector Block

NOTES

The default setting (no jumpers installed) for the tape system is SCSI ID 5. A jumper must **always** be placed on pin pair **9 / 10** (SCSI ID Present) for the host to recognize **any** SCSI ID selections made on this connector, otherwise, the SCSI ID remains SCSI ID 5.

Note that the SCSI ID of the host adapter is typically SCSI ID 7.

SCSI ID	Pin Pair 7 / 8	Pin Pair 5 / 6	Pin Pair 3 / 4	Pin Pair 1 / 2
0	0	0	0	0
1	0	0	0	1
2	0	0	1	0
3	0	0	1	1
4	0	1	0	0
5 *	0	1	0	1
6	0	1	1	0
7	0	1	1	1
8	1	0	0	0
9	1	0	0	1
10	1	0	1	0
11	1	0	1	1
12	1	1	0	0
13	1	1	0	1
14	1	1	1	0
15	1	1	1	1

* = Default SCSI ID setting is SCSI ID 5.

0 = No jumper block installed on pin pair

1 = Jumper block installed on pin pair

Table 2-1 SCSI ID Jumper Settings

2.2.2. Setting TERM PWR

A SCSI bus must be terminated at each end of the bus. At least one device on the bus must supply terminator power (TERM PWR).

To configure the DLT8000 tape drive to supply TERM PWR, install a jumper block on pin pair 3 / 4 (Figure 2-2).

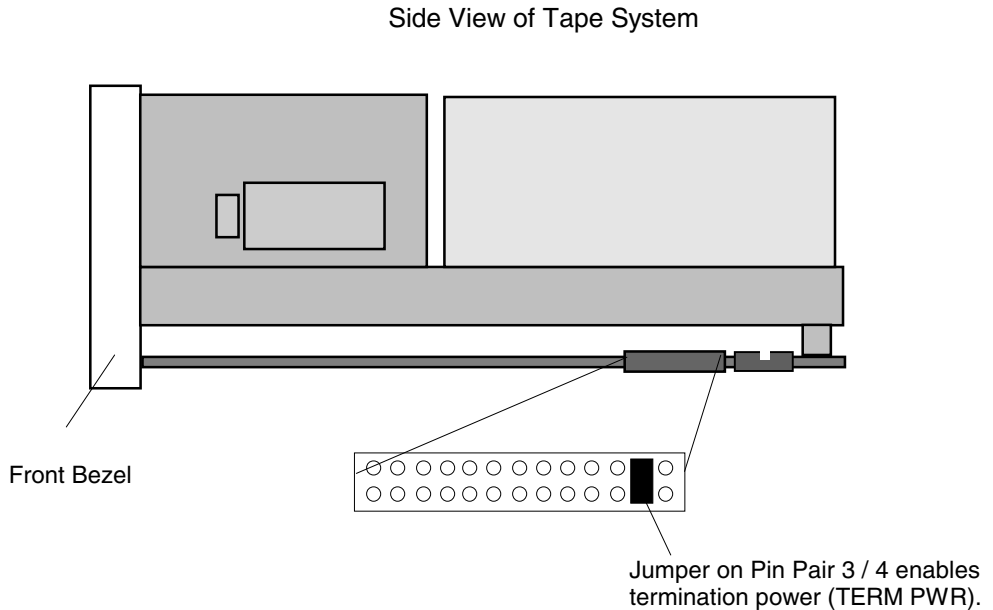

*Figure 2-2 Jumper Installed on Pin Pair 3 / 4
Enables Termination Power (TERM PWR)*

2.2.3. Setting Parity Checking

Parity checking is the default setting for DLT8000 tape systems. If the system to which you are configuring the tape system does not generate parity, disable parity checking on the tape system by installing a jumper block on pin pair 1 / 2 on the connector as shown in Figure 2-3. Note that this is the same connector as the one used to select the setting for TERM PWR (Section 2.2.2).

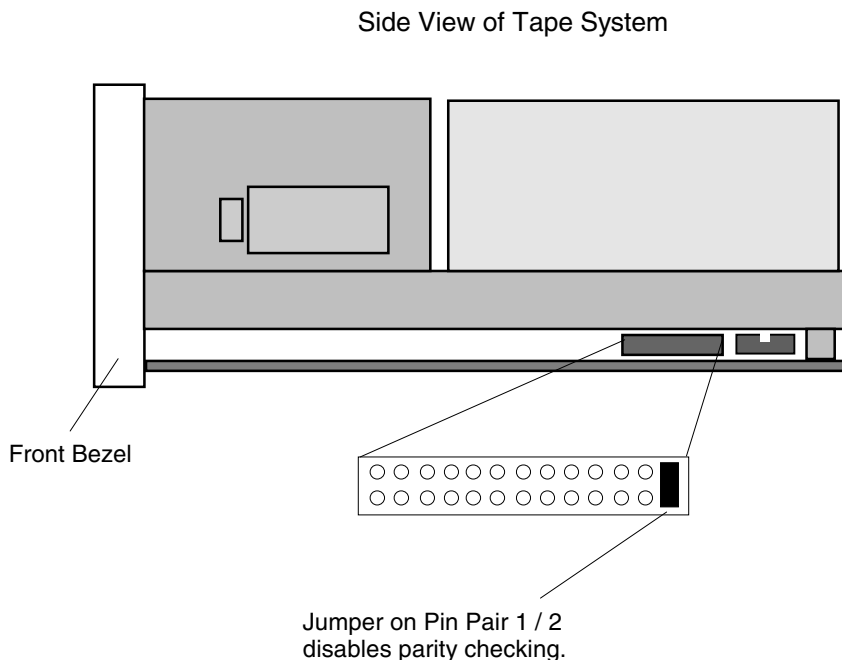

*Figure 2-3 Jumper Installed on Pin Pair 1 / 2
Disables Parity Checking*

2.2.4. Installing the Tape System

Installing the tape system requires securing the tape system in its bay or chassis and connecting SCSI bus and power cables.

2.2.4.1 . Securing the Tape System in Bay or Chassis

Using four (4) screws, secure the tape system in its bay or chassis.

Figure 2-4 is a dimensional drawing that shows the locations of the mounting holes at the bottom and sides of the tape system.

Note that screws used to mount the tape system must be #6-32 UNC-2B screws. When the recommended size screws are used, there is no danger of the screws touching electronic components or otherwise damaging the tape system.

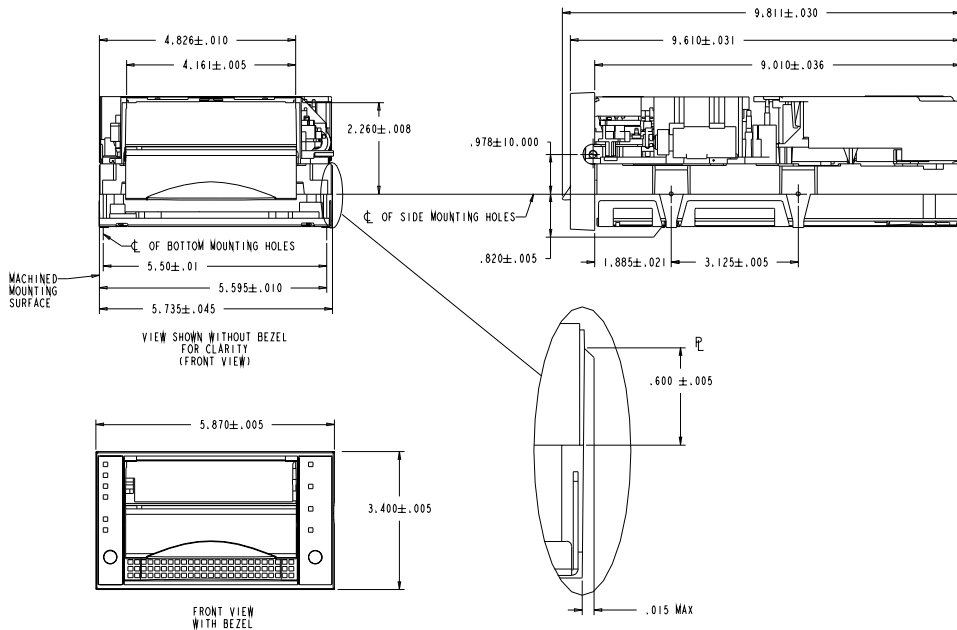

Figure 2-4 Locations and Dimensions for Mounting Holes

2.2.4.2 . Connecting SCSI Bus and Power Cables

Carefully connect the appropriate SCSI and power cables to their matching connectors.

Figure 2-5 shows the location of the SCSI and power connectors on the rear of the tape system. Tables 2-2 through 2-4 provide SCSI pin signal names/locations for the SCSI connectors. Table 2-5 provides power connector signal names/locations.

NOTE

In some installations, it may be easier to connect the SCSI bus and power cables before securing the tape system in its bay or position within its cabinet or chassis.

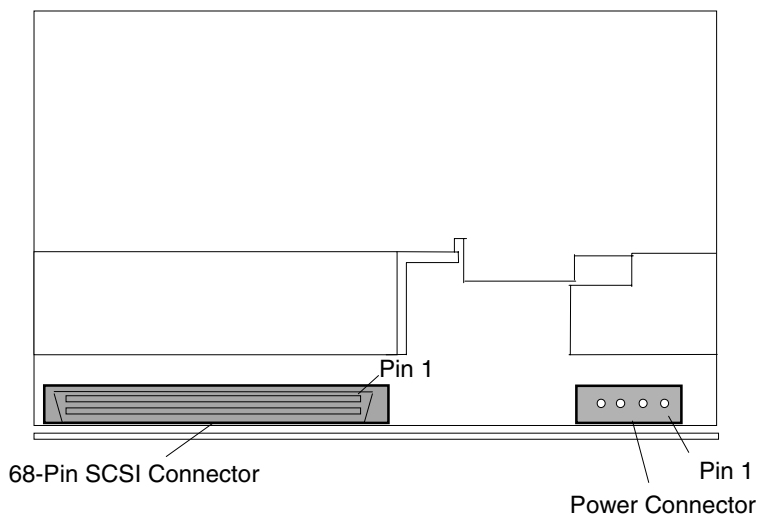

Rear View (Connector End) of Tape System

Figure 2-5 Connectors for SCSI Bus Cable and Power Cable

Signal Name	Pin Number	Pin Number	Signal Name
Signal Return	1	35	-DB(12)
Signal Return	2	36	-DB(13)
Signal Return	3	37	-DB(14)
Signal Return	4	38	-DB(15)
Signal Return	5	39	-DB(P1)
Signal Return	6	40	-DB(0)
Signal Return	7	41	-DB(1)
Signal Return	8	42	-DB(2)
Signal Return	9	43	-DB(3)
Signal Return	10	44	-DB(4)
Signal Return	11	45	-DB(5)
Signal Return	12	46	-DB(6)
Signal Return	13	47	-DB(7)
Signal Return	14	48	-DB(P0)
Signal Return	15	49	Ground
Ground (DIFFSENS)	16	50	Ground
TERMPWR	17	51	TERMPWR
TERMPWR	18	52	TERMPWR
Reserved	19	53	Reserved
Ground	20	54	Ground
Signal Return	21	55	-ATN
Ground	22	56	Ground
Signal Return	23	57	-BSY
Signal Return	24	58	-ACK
Signal Return	25	59	-RST
Signal Return	26	60	-MSG
Signal Return	27	61	-SEL
Signal Return	28	62	-C/D
Signal Return	29	63	-REQ
Signal Return	30	64	-I/O
Signal Return	31	65	-DB(8)
Signal Return	32	66	-DB(9)
Signal Return	33	67	-DB(10)
Signal Return	34	68	-DB(11)

Note: The minus sign (-) next to a signal indicates active low.

Table 2–2 68-Pin Single-Ended Configuration SCSI Connector Signal Names

Signal Name	Pin Number	Pin Number	Signal Name
+DB(12)	1	35	-DB(12)
+DB(13)	2	36	-DB(13)
+DB(14)	3	37	-DB(14)
+DB(15)	4	38	-DB(15)
+DB(P1)	5	39	-DB(P1)
+DB(0)	6	40	-DB(0)
+DB(1)	7	41	-DB(1)
+DB(2)	8	42	-DB(2)
+DB(3)	9	43	-DB(3)
+DB(4)	10	44	-DB(4)
+DB(5)	11	45	-DB(5)
+DB(6)	12	46	-DB(6)
+DB(7)	13	47	-DB(7)
+DB(P)	14	48	-DB(P)
GROUND	15	49	GROUND
DIFFSENS	16	50	GROUND
TERMPWR	17	51	TERMPWR
TERMPWR	18	52	TERMPWR
RESERVED	19	53	RESERVED
GROUND	20	54	GROUND
+ATN	21	55	-ATN
GROUND	22	56	GROUND
+BSY	23	57	-BSY
+ACK	24	58	-ACK
+RST	25	59	-RST
+MSG	26	60	-MSG
+SEL	27	61	-SEL
+C/D	28	62	-C/D
+REQ	29	63	-REQ
+I/O	30	64	-I/O
+DB(8)	31	65	-DB(8)
+DB(9)	32	66	-DB(9)
+DB(10)	33	67	-DB(10)
+DB(11)	34	68	-DB(11)

Table 2-3 68-Pin Wide LVD Version SCSI Connector Signal Names

Signal Name	Pin Number	Pin Number	Signal Name
+DB(12)	1	35	-DB(12)
+DB(13)	2	36	-DB(13)
+DB(14)	3	37	-DB(14)
+DB(15)	4	38	-DB(15)
+DB(P1)	5	39	-DB(P1)
Ground	6	40	Ground
+DB(0)	7	41	-DB(0)
+DB(1)	8	42	-DB(1)
+DB(2)	9	43	-DB(2)
+DB(3)	10	44	-DB(3)
+DB(4)	11	45	-DB(4)
+DB(5)	12	46	-DB(5)
+DB(6)	13	47	-DB(6)
+DB(7)	14	48	-DB(7)
+DB(P)	15	49	-DB(P)
DIFFSENS	16	50	Ground
TERMPWR	17	51	TERMPWR
TERMPWR	18	52	TERMPWR
Reserved	19	53	Reserved
+ATN	20	54	-ATN
Ground	21	55	Ground
+BSY	22	56	-BSY
+ACK	23	57	-ACK
+RST	24	58	-RST
+MSG	25	59	-MSG
+SEL	26	60	-SEL
+C/D	27	61	-C/D
+REQ	28	62	-REQ
+I/O	29	63	-I/O
Ground	30	64	Ground
+DB(8)	31	65	-DB(8)
+DB(9)	32	66	-DB(9)
+DB(10)	33	67	-DB(10)
+DB(11)	34	68	-DB(11)

Note: The minus sign (-) next to a signal indicates active low.

Table 2-4 68-Pin Differential Version SCSI Connector Signal Names

Pin	Signal
1	+12 VDC
2	Ground (+12 V return)
3	Ground (+5 V return)
4	+5 VDC

Table 2-5 Power Connector Signal Names

2.2.4.3. The Loader Connector

Located on the side of the integratable tape system (Figure 2-6), the loader connector provides signals used when the tape system is part of a loader configuration.

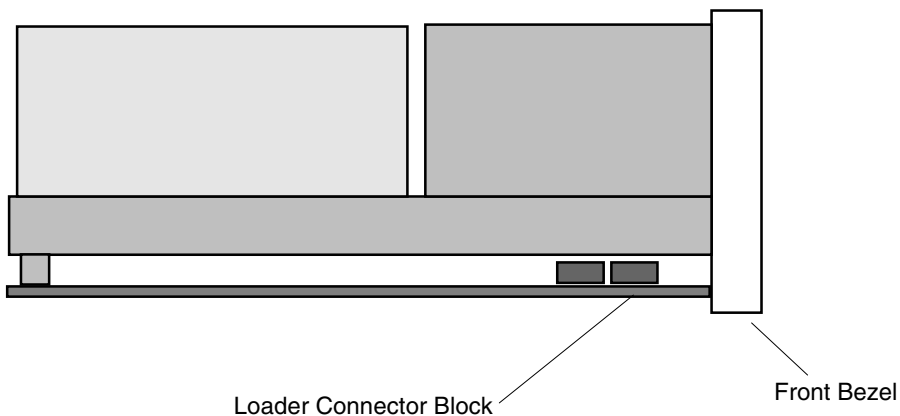

Figure 2-6 Loader Connector Block

2.3. Configuring and Installing a Tabletop Tape System

This section provides instructions for configuring and installing the tabletop version of the tape system. The tabletop version is enclosed in a top cover and the enclosure includes a separate power supply. The power switch and the SCSI ID selection switch are located on the unit's rear panel. SCSI cables and the unit's ac power cable are connected at the rear panel.

WARNING

Before you begin, review the Safety, ESD, and Handling precautions described at the beginning of this chapter to avoid personal injury or damage to equipment.

This section contains information about configuring ("tailoring") the tape system via the unit's external switches. Settings are included for the following options:

Option	See Section....
SCSI ID Selection	2.3.1
Connecting SCSI Cable(s) and/or Terminators	2.3.2
Connecting AC Power Cable	2.3.3

NOTE

To disable parity, contact your service representative. There are no external switches on the tabletop version to disable parity checking.

Figure 2-7 provides physical dimensions of the tabletop unit.

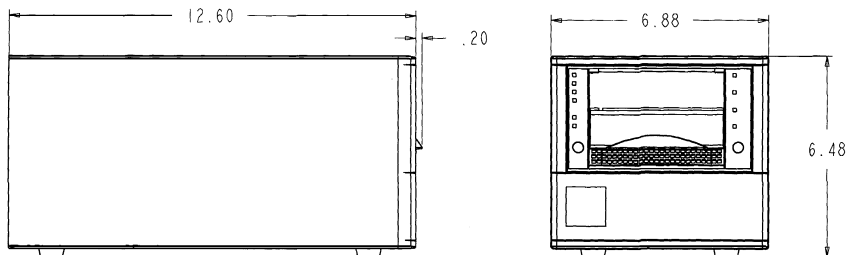

Figure 2-7 Physical Dimensions of DLT8000 Tabletop System

2.3.1. Selecting SCSI ID

Select the appropriate SCSI ID for the tabletop version of the tape system by incrementing or decrementing the number displayed on the SCSI ID selection switch on the tabletop tape system's rear panel (Figure 2-8). Press either the small switch above the indicator to increment the number, or the small switch below the indicator to decrement the number.

Note that the default SCSI ID of the system is SCSI ID 3.

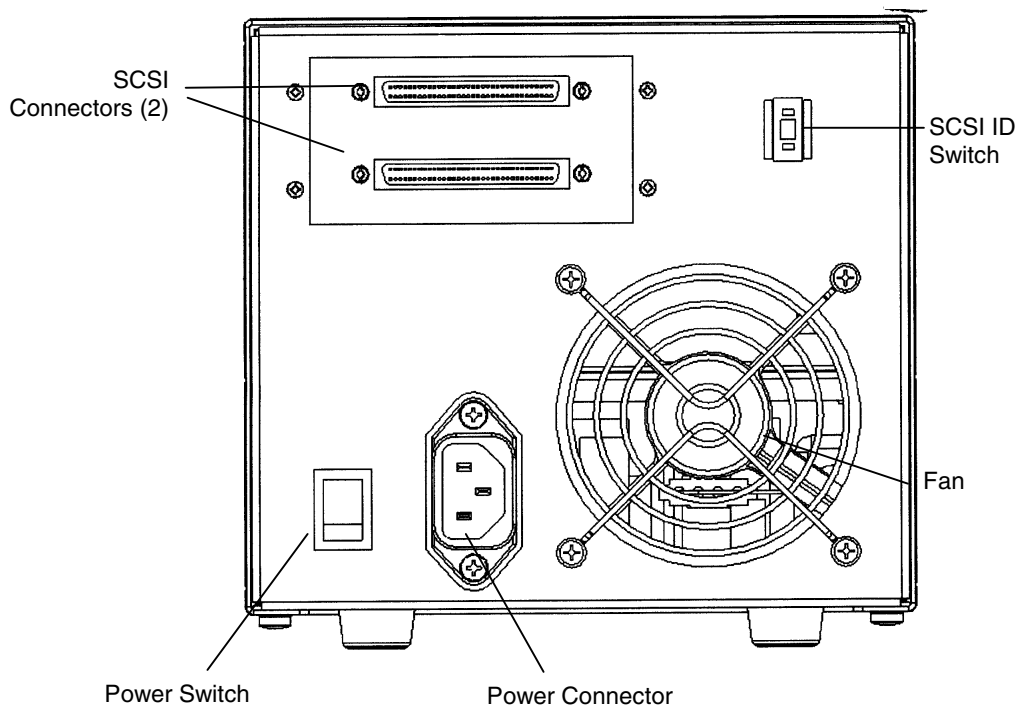
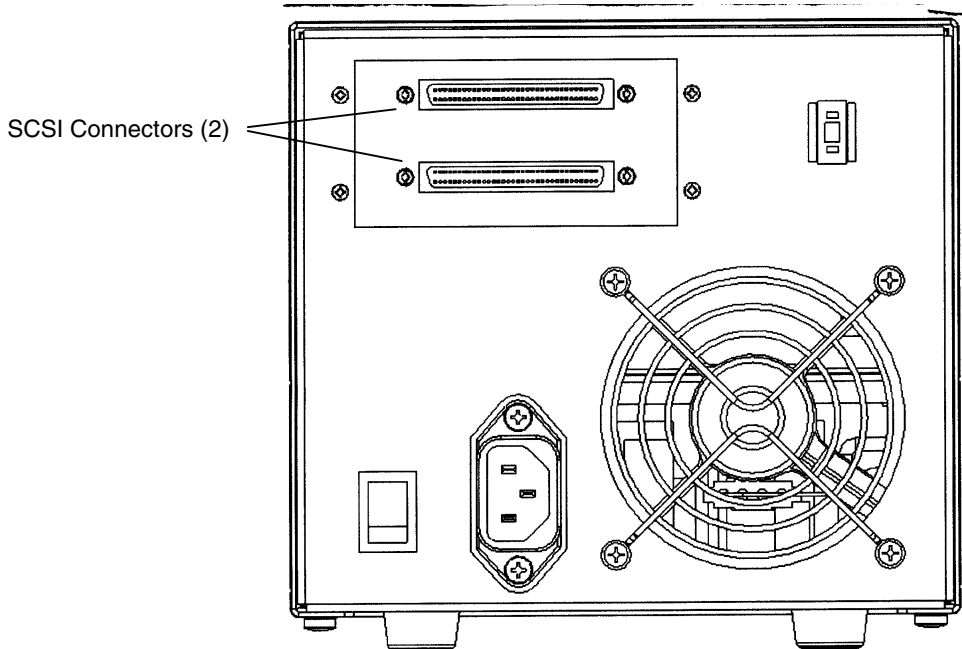

Figure 2-8 DLT8000 Tabletop Tape System Rear Panel

2.3.2. Connecting the SCSI Bus Cables

Figure 2-9 shows the locations of the two SCSI bus connectors on the rear panel of the tabletop tape system. The SCSI bus cable leading from the host adapter can be connected to either of the connectors. If the tape unit is the last device on the bus, then a terminator should be installed on the open connector. If the bus continues from the tape system to another SCSI device, then install a SCSI bus cable between the open connector and the next device on the bus.



Terminators

68-Pin LVD/SE Terminator

68-Pin HVD Differential Terminator

*Figure 2-9 Location of SCSI Bus Connectors on Rear Panel
(Tabletop Version)*

2.3.3. **Installing the AC Power Cord**

WARNING

Do not attempt to modify or use an external 100 - 115 VAC power cord for 220 - 240 VAC input power. Modifying the power cord in any way can cause personal injury and severe equipment damage.

An ac power cord is supplied with each tabletop tape unit. Carefully inspect the power cord and ensure that the cord is the appropriate cord for your country or region based on the criteria below.

The ac power cord used with the tabletop tape unit must meet the following criteria:

1. The power cord should be a minimum of 18/3 AWG, 60°C, Type SJT or SVT.
2. UL and CSA Certified cordage rated for use at 250 VAC with a current rating that is at least 125% of the current rating of the product.
3. The ac plug must be terminated in a grounding-type male plug designed for use in your country or region. It must also have marks showing certification by an agency acceptable in your country or region.
4. The connector at the tabletop unit end of the cord must be an IEC type CEE-22 female connector.
5. The cord must be no longer than 14.5 feet (4.5 meters).

Figure 2-10 shows different ac power cord plug-end configurations for 115 V and 220 / 240 V usage.

Note that the power supply of the tabletop unit has an auto-sensing feature; no adjustment or switch setting changes are required for different ac sources.

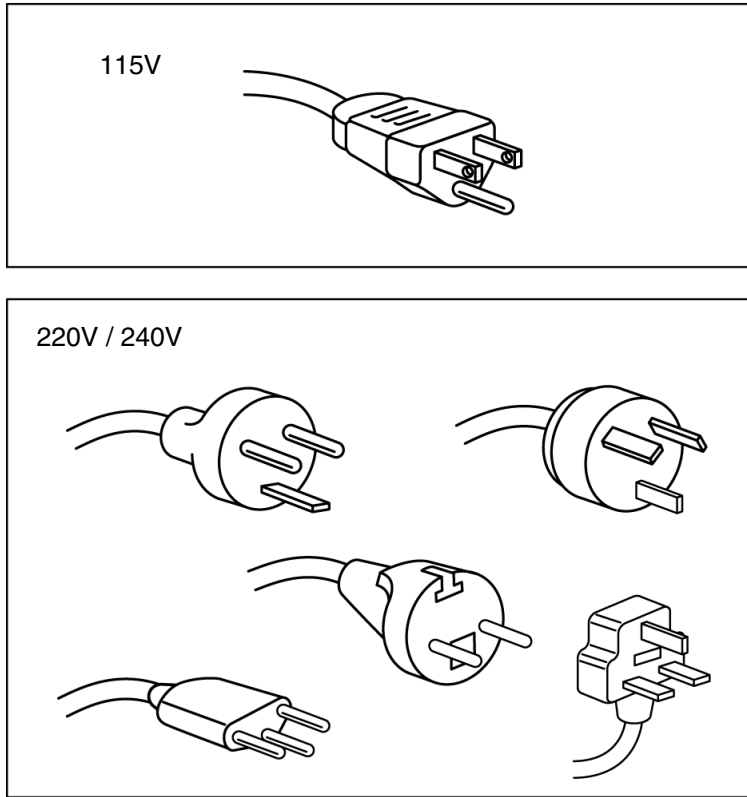
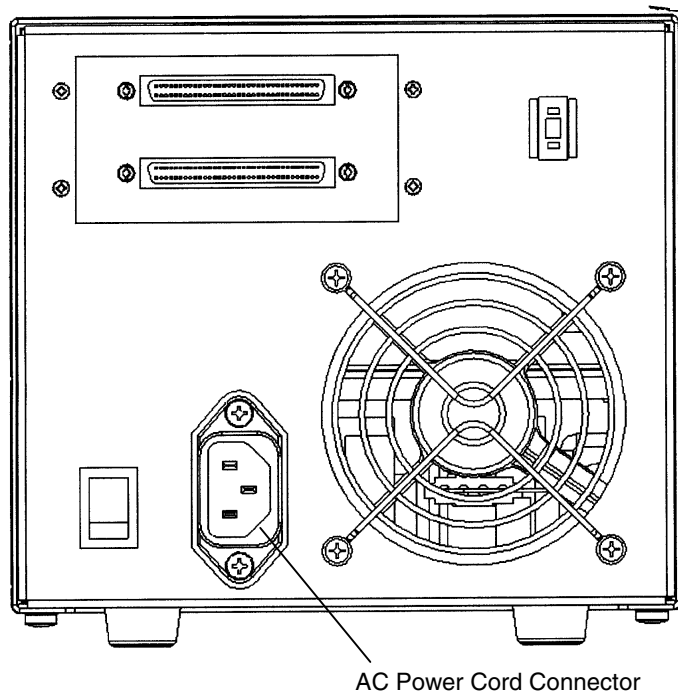

Figure 2-10 AC Power Cord Plug Ends

Figure 2-11 shows the location of the ac power cord connector on the tabletop tape system's rear panel.



*Figure 2-11 Location of AC Power Cord Connector on Rear Panel
(Tabletop Version)*

2.4 . The Tape Cartridge

The tape system can use one of the following types of DLTtape cartridge:

Type	Plastic Color	Feet/Cartridge
DLTtape III	Greyish Brown	1200
DLTtape IIIXT	White	1800
DLTtape IV	Black	1800

This section of the manual covers handling and care of tape cartridges, discusses the tape cartridge write-protect switch, and explains how to load and unload a tape cartridge to and from the tape system, and how to use a cleaning tape cartridge

Topic	See Section....
Care and Handling of Tape Cartridges	2.4.1
Tape Cartridge Write-Protect Switch	2.4.2
Loading a Tape Cartridge	2.4.3
Unloading a Tape Cartridge	2.4.4
How to Use a Cleaning Tape Cartridge	2.4.5

Table 2–6 Tape Cartridge Topics Discussed in this Manual

2.4.1. Care and Handling of Tape Cartridges

Although designed and manufactured to withstand much handling and use, tape cartridges should be handled properly.

- Do not carry cartridges loosely in a box or other container that exposes them to unnecessary physical shock.
- Store each cartridge vertically in its protective case until needed.
- Do not drop or bump the cartridge; this may dislodge and/or damage internal components.
- Avoid unnecessary opening of the cartridge door; this may expose the tape to contamination or physical damage.
- Do not allow direct contact with tape medium or the tape leader. Dust or natural skin oils can contaminate the tape and impact performance.
- Do not expose the cartridge to moisture or direct sunlight, dampness, or condensation.
- Maintain clean operating, working, and storage environments.
- Do not place cartridges on or near devices that may produce magnetic fields such as computer monitors, motors, or video equipment. Such exposure may alter or erase data on the tape.
- Do not attempt to remove a tape cartridge from the tape system unless the Operate Handle indicator is illuminated steadily. Overriding the system handle will cause damage to both the media and the tape system.

- The ambient operating environment for the tape cartridge is

Temperature	10°C to 40°C (50°F to 104°F)
Relative Humidity	20% to 80% (non-condensing)

If storage and/or transportation of a tape cartridge has exposed it to conditions outside the ambient values above, you should “condition” the tape cartridge to its operating environment for a 24-hour period.

- Place labels only in the front slide slot of the cartridge. Do not put any label on the top, bottom, sides, or rear of the cartridge. This may interfere with normal cartridge operation and may damage other subsystem components.
- Do not use graphite pencils, water-soluble felt pens, or other debris-producing writing instruments on your labels. Never erase a label – replace it.
- Make sure you place the unused cartridge labels in the protective box so that you do not inadvertently pick them up along with the cartridge during subsequent usage. A static electricity charge on a cartridge may cause a label to cling to the cartridge. A label that is accidentally inserted into the system along with a cartridge can prevent the hub reel and system gear from meshing.
- Follow all instructions for tape cartridge handling that accompany your cartridges or tape system.

2.4.2. Tape Cartridge Write-Protect Switch

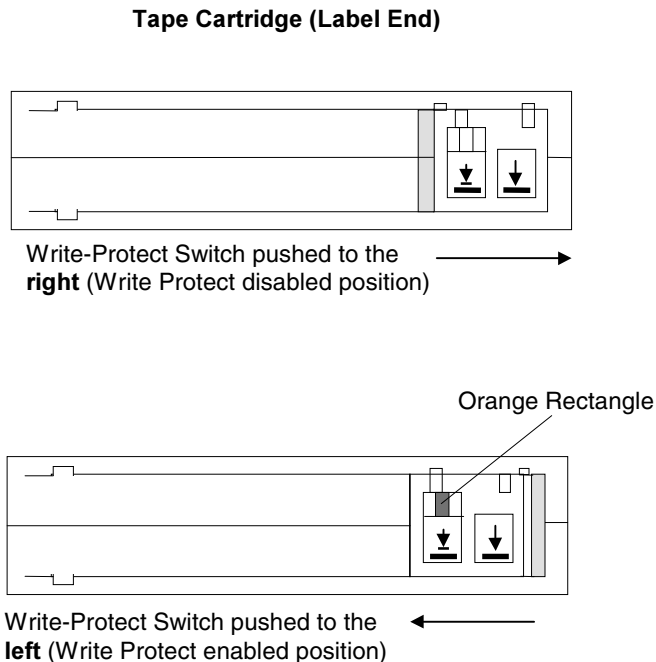

Figure 2-12 Write-Protect Switch on Tape Cartridge

Each tape cartridge has a write-protect switch that can be used to prevent accidental erasure of data. Before inserting the tape cartridge into the tape system, position the write-protect switch on the front of the cartridge:

- Move the write-protect switch to the left to **enable** write protection (existing data on the tape cannot be overwritten, nor can additional data be appended to the media).

When the write-protect switch is moved to the left, a small orange rectangle is visible. This indicates that data cannot be written to the tape.

- Move the write-protect switch to the right to **disable** write protection (existing data on the tape can be overwritten, and/or additional data can be appended to the media unless the cartridge is write-protected via software). When write-protect is disabled, no orange rectangle is visible.

When a tape cartridge is loaded in the system and the tape cartridge's write-protect switch is moved to its write-protected position (to the left as you face the label/switch side of the tape cartridge), the system turns on its Write Protect indicator immediately. If the system is currently writing to the tape, the write-protect feature does not take effect until after the current WRITE operation completes.

Table 2-7 describes the impact of moving the write-protect switch to its enabled position before loading the cartridge; Table 2-8 describes the impact of doing so when the switch is moved during a WRITE operation.

If the write-protect switch is moved....	Then....
To its left (enabled) position, the orange indicator on the cartridge becomes visible	Data cannot be written to the tape.
To its right (disabled position), the orange indicator is not visible	Data can be written to the tape (unless software write-protect is in effect).

Table 2-7 Enabling Write-Protect Before Loading the Cartridge

If the write-protect switch is moved....	Then....
From its left (enabled) position to its right (disabled, or write-enabled) position (orange indicator is no longer visible)	The tape becomes write-enabled AFTER a variable amount of seconds.
From its right (disabled, or write-enabled) position to its left (enabled) position (orange indicator becomes visible)	The tape becomes write-protected AFTER a variable amount of seconds (and once any current WRITE operation is completed).

Table 2-8 Enabling Write-Protect After Loading the Cartridge and During Operation

2.4.3. Checking a Tape Cartridge

Before you insert any tape cartridge, you should inspect it to ensure that it is not damaged.

Refer to Appendix F for a detailed visual mechanical inspection procedure and other DLTtape cartridge-related information.

- Open the tape cartridge door and check the position of the tape leader.
- Close the tape cartridge door and shake the cartridge, listening for a rattle sound.

CAUTION

If the tape leader is missing or incorrectly positioned or if you hear a rattling sound, the cartridge may be damaged. Inserting a damaged cartridge into a tape system will damage the system. Discard any damaged tape cartridges.

2.4.4 Loading a Cartridge

NOTE

Because this section of the manual includes descriptions of the states of indicators on the tape system, it may be useful to review sections of this chapter that describe tape system indicators, their states, and meanings of states.

Follow these steps to load a tape cartridge into the front panel of the tape system. Figure 2-13 illustrates the tape system's front panel.

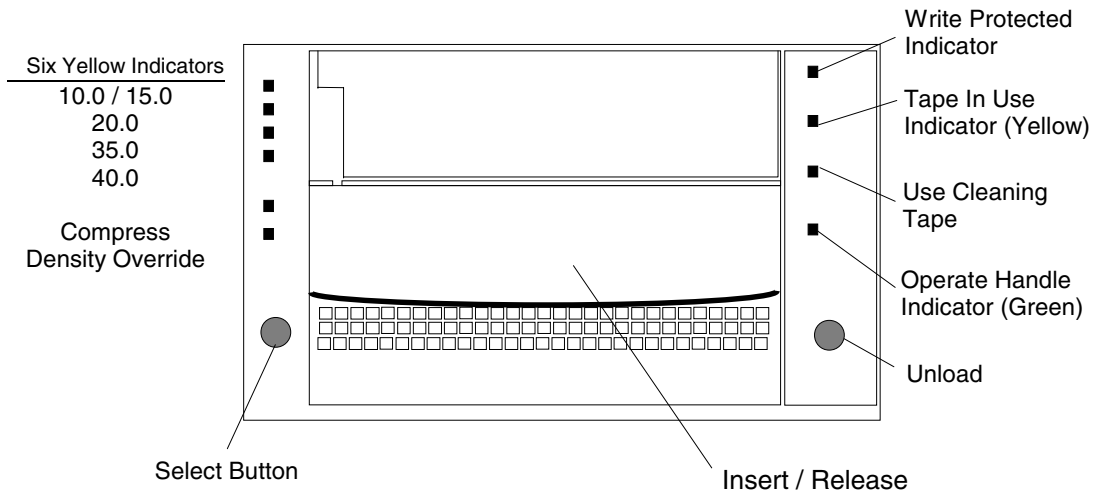

Figure 2-13 Front Panel of Tape System

1. When the green Operate Handle indicator is steadily illuminated, lift the tape system's cartridge Insert/Release handle.

NOTE

If the green Operate Handle indicator is blinking, close the handle and wait for the indicator to illuminate steadily, then lift the handle and insert the cartridge.

Do not attempt to load a cartridge when the green Operate Handle indicator is blinking; damage to the system may result.

2. Insert the cartridge. Push the cartridge fully into the tape system.

CAUTION

To prevent failures and/or damage to the handle, assist the handle to its closed position. Do not flip it or otherwise treat it roughly. Do not leave your fingers under the handle: doing so may cause you to operate the handle in an incorrect manner.

3. Push the handle to its closed (down) position.

The green Operate Handle indicator extinguishes and the yellow Tape in Use indicator blinks to show that the tape is loading. When the tape reaches the BOT marker, following calibration, the yellow indicator illuminates steadily. The tape is now ready for use.

2.4.5. Unloading a Cartridge

NOTE

Because this section of the manual includes descriptions of the states of indicators on the tape system, it may be useful to review sections of this chapter that describe tape system indicators, their states, and meanings of states.

Follow the steps below the first **CAUTION** notice to unload a tape cartridge.

CAUTION

Always remove the tape cartridge from the tape system **BEFORE** turning off host power. Failure to remove a tape cartridge may result in cartridge and/or tape system damage.

When you remove a tape cartridge from the system, return the cartridge to its plastic case to protect the cartridge from damage.

1. Press the Unload button (or issue an appropriate system software command). The yellow Tape in Use indicator blinks as the tape rewinds.

CAUTION

Do **NOT** rush removal of the tape cartridge: premature removal can cause tape leader failure. Wait until the Operate Handle indicator illuminates a steady green. Delay removing the tape cartridge for one or two seconds to ensure that the tape leader of the cartridge is in a safe position for cartridge removal.

2. When the green Operate Handle indicator illuminates steadily, lift the tape system cartridge Insert/Release handle to its open position to eject the cartridge.
3. Remove the cartridge.
4. Push the Insert/Release handle to its closed position.

2.4.6. How and When to Use a Cleaning Tape Cartridge

NOTE

Because this section of the manual includes descriptions of the states of indicators on the tape system, it may be useful to review sections of this chapter that describe tape system indicators, their states, and meanings of states.

Use Table 2-9 to determine when to use a cleaning tape cartridge.

If	It means	And you should....
The Use Cleaning Tape indicator is steadily illuminated	The recording head needs cleaning or the tape is bad.	Use the cleaning cartridge. Follow the instructions in this chapter for loading a cartridge into the tape system. When cleaning completes, the Use Cleaning Tape indicator extinguishes and the Operate Handle indicator illuminates to alert you that the cartridge can be removed from the tape system.
A data tape cartridge causes Use Cleaning Tape indicator to be illuminated steadily following the use of a cleaning cartridge	The data cartridge may be damaged.	If possible, back up the data from this cartridge onto another cartridge. Discard the damaged cartridge: use of a damaged cartridge may cause unnecessary use of the cleaning cartridge.

Table 2-9 When to Use a Cleaning Cartridge

If	It means	And you should....
The Use Cleaning Tape indicator continues to be illuminated steadily after you have used a cleaning cartridge to clean the recording head	Your cleaning tape cartridge may be exhausted.	Try another cleaning tape cartridge.
The Use Cleaning Cartridge indicator is illuminated steadily while the tape system is in its tape cleaning process	Cleaning of the system had has not taken place; the cartridge has expired.*	Wait until the tape is unloaded and the green Operate Handle indicator illuminates. Replace the cleaning cartridge.
All indicators on the right-hand side of the front bezel are blinking	There may be a system fault	Operate the handle to remove the cartridge. Inspect the tape cartridge. If the cartridge appears undamaged, it may be used again, otherwise, take the cartridge out of service. Reset the tape drive and load a known good cartridge. If all indicators on the right-hand side of the bezel blink again during the load, have the tape drive serviced.

* A cleaning cartridge has a life expectancy of about 20 uses.

Table 2–9 When to Use a Cleaning Cartridge (continued)

2.5 Operating the Tape System – Controls and Indicators

Operating the tape system requires use of a tape cartridge and the controls and indicators on the front panel, or bezel, of the tape system.

All controls and indicators are located on the tape system's front panel or bezel (Figure 2-13). Use these controls and indicators to operate the tape system and monitor the tape system's activities.

See below for directions to which sections of this manual to use for explanations of controls and indicators

Control / Indicator	See Section....
Unload Button (Figure 2-13)	2.5.1
Cartridge Insert/Release Handle (Figure 2-13)	2.5.2
Selecting Density	2.5.3

2.5.1. Unload Button

Use the Unload Button to unload the tape cartridge. When a user pushes the Unload Button, the tape system waits until any active writing of data to tape is completed, then begins its unload sequence.

The tape system rewinds the tape medium back into the cartridge and writes the current or updated tape directory to the tape. The tape must be completely rewound and unloaded into the cartridge before the cartridge can be removed from the tape system. A complete unload operation may take 17 seconds from Beginning of Tape (BOT).

Note that if the tape system is in an error state (all indicators on the right- or left-hand side of the front panel are flashing), pushing the Unload Button causes the tape system to reset and unload the tape, if possible.

2.5.2. Cartridge Insert/Release Handle

Use the Cartridge Insert/Release Handle to load or eject a tape cartridge only when the tape system's Operate Handle indicator is illuminated. Lift the handle to its fully open position, or lower it to its fully closed position.

2.5.3. Selecting Density

CAUTION

If the tape is not positioned at End of Data (EOD), a WRITE to the tape will deny access to previously-recorded data beyond the current tape position. To prevent this, position the tape to EOD, then perform the WRITE. This condition is termed an “appended WRITE.”

NOTES

1. Default capacity of a DLTtape™ III cartridge is 10.0 GB, native or 20.0 GB (compression ON).
2. Default capacity of a DLTtape IIIXT cartridge is 15.0 GB, native (compression OFF), or 30.0 GB (compression ON).
3. Default capacity of a DLTtape IV cartridge is 40.0 GB, native (compression OFF), or 80 GB, compressed. A capacity of 35.0 GB native (compression OFF, or 70 GB, compressed OR 20.0 GB native (compression OFF), or 40 GB, compressed, is user-selectable.

Various storage capacities can be selected by specifying the *density* of the data to be recorded on the tape media.

Using the DLTtape IV cartridge:

1. On all READ and all WRITE APPEND operations, the data density that already exists on the tape cartridge remains the density.
2. When writing from BOT, tape density may be changed by:
 - Using the Density Select Button on the front panel of the tape system.
Using the front panel’s Density Select Button always overrides density selection via the host.
 - Using the operating system to issue a density designation. In this case, the yellow Density Override indicator on the tape system’s front panel is extinguished, indicating an automatic or host density selection.

Native default capacity for the DLTtape IV is 40.0 GB (80.0 GB, compressed), assuming the Density Select Button was not used or that host selection of density via the operating system was not invoked.

To select density on the tape system,

Load the tape cartridge into the tape system. The yellow Tape in Use indicator blinks while the tape loads and calibrates.

After calibration is complete, the Tape In Use indicator remains steadily illuminated. The appropriate tape density indicator along the left edge of the system's front panel illuminates to indicate the tape's prerecorded density (if any).

Use the tape system's density Select Button to select the desired density, if different than that indicated by the illuminated tape density indicator. Density selection is inactive until a WRITE from BOT is issued. The controller retains the selected density until 1) the density selection is changed, or 2) the tape is unloaded.

An example of selection of density follows.

EXAMPLE:

A user loads a tape cartridge previously recorded at 20.0 GB capacity. The user then presses the Density Select Button to select the density for 40.0 GB capacity. The following events take place:

- The yellow 20.0 indicator remains illuminated – the density has not yet changed and the steadily illuminated indicator reflects the tape's recorded density.
- The yellow 40.0 indicator blinks – this signals that a density change is pending.
- The yellow Density Override indicator illuminates.

When a WRITE from BOT occurs:

- The yellow 20.0 indicator extinguishes
- The yellow 40.0 indicator illuminates steadily
- The yellow Density Override indicator remains illuminated

Table 2-10 explains the activity of indicators during density selection.

If...	Then...
The Density Select Button is not used	The illuminated indicators show data density when the tape is being read from and written to. The indicators illuminate steadily; Density Override remains extinguished.
The Density Select Button is used and the actual recorded density is the same as the density selected via the button	The indicator that reflects the actual data density and the Density Override indicators both are illuminated. For example, if the actual data density is set for 10.0 GB and 10.0 GB is selected via the Select Button, the indicator next to "10.0" illuminates.
The Density Select Button is used and the actual recorded density differs from the density selected via the button	<ol style="list-style-type: none"> <li data-bbox="701 665 1072 749">1. The indicator that reflects the actual data density illuminates steadily. <li data-bbox="701 766 1030 824">2. The indicator reflected the SELECTED density blinks. <li data-bbox="701 841 1100 900">3. The Density Override illuminates steadily. <p data-bbox="701 917 1107 1102">For example, if the actual tape data density is set for 40.0 GB and the selected density is 20.0 GB, the 40.0 indicator lights steadily, the 20.0 indicator blinks, and the Density Override indicator illuminates steadily.</p>

Table 2–10 Indicator Light Activity During Density Selection

To select density via the host over the SCSI bus,

1. Use the SCSI MODE SELECT command to indicate the desired data density (Chapter 5).
2. Write data to the tape from BOT.

2.6. Power On Self Test (POST) and Indicator Activity During POST

When power is applied to the tape system, it performs power-on self testing (POST). The sequence of events that may be observed is:

Stage	What Can be Observed
1	Indicators on the right-hand side of the front panel illuminate in sequence from top to bottom. All indicators remain illuminated for a few seconds.
2	The indicators along the left-hand side of the front panel illuminate together for about three seconds, then extinguish.
3	The green Operate Handle, orange Write Protected, and yellow User Cleaning Tape indicators extinguish. The yellow Tape in Use indicator blinks while the tape system initializes.
4	Following initialization, the tape system is in one of the states described in Table 2-12.

Table 2-11 Indicator Activity During POST

State	Indicator Display and Activity
A tape cartridge is present and the handle is down	The tape system loads the medium from the cartridge. When the yellow Tape In Use indicator stops blinking and remains illuminated. The indicator next to the tape's actual density is illuminated. When Density Override blinks, a density may be selected. The tape system is ready for use and the media is positioned at BOT.
No tape cartridge present	<ol style="list-style-type: none"> 1. Yellow Tape in Use indicator extinguishes. 2. Green Operate Handle indicator illuminates. 3. Insert/Release Handle is unlatched.

Table 2-12 Possible Tape System States Following Initialization

State	Indicator Display and Activity
A tape cartridge is present, but the handle is up (not recommended)	The yellow Tape In Use indicator extinguishes. The green Operate Handle indicator flashes. When the Insert/Release Handle is lowered, the cartridge loads. If handle will not lower, ensure the tape cartridge is pushed all the way into the tape system.
The tape system detects an error condition	Right- or left-hand indicators blink repeatedly. Try to unload the tape and reinitialize the tape system by pressing the Unload button, or turn system power off then back on. The indicators stop blinking and the system attempts reinitialization. Note that after pressing the Unload button you may have to wait five minutes before the Operate Handle indicator illuminates due to the retry being attempted first. The indicators illuminate steadily, then extinguish if the test succeeds.
The system is powered on with the handle in open position	Operate Handle indicator is blinking. Close the Insert/Release Handle and wait for indicator to illuminate steadily.

Table 2–12 Possible Tape System States Following Initialization (continued)

POST completes in about 15 seconds and the tape system should respond normally to all commands (POST is complete after Stage 2 in Table 2-11). However, it might take longer for the media to become ready.

After a bus reset, the tape system responds within a bus selection time-out period (per the ANSI SCSI specification). A reset may have the Tape In Use indicator blinking because a reset forces the tape to be rewound to BOT.

2.7. Tape System Operating Modes and Indicator Activity

Table 2-13 describes the various operating conditions of a tape system and what observations can be made of the various indicators for each mode. A detailed description of the modes for the Tape in Use indicator is provided.

Front Panel Indicator	Color of Indicator	State	Operating Mode
Write Protected	Orange	On	Tape is Write-Protected
Tape in Use	Yellow	Off	Tape is Write-Enabled
		Blinking	Tape is moving
Use Cleaning Tape	Yellow	On	Tape is loaded; ready for use.
		Off	Tape not loaded
		On	Tape system needs cleaning or tape is bad.
		Remains on after cleaning tape unloads	Cleaning tape attempted to clean the system head, but the tape expired so cleaning was not done.
Operate Handle	Green	After cleaning, indicator illuminates again when (data) tape cartridge is reloaded.	Problem tape cartridge. Try another cartridge. If problem indication persists, contact service representative.
		Off	Cleaning is complete or cleaning is unnecessary.
		On	Insert/Release handle can be operated.
		Blinking	Do not operate Insert/Release handle. Close the Insert/Release handle and wait for Operate Handle indicator to illuminate steadily

Table 2–13 Tape System Operating Modes / Indicator Activity

Front Panel Indicator	Color of Indicator	State	Operating Mode
All four right-hand or all six left-hand indicators	---	On Blinking	POST is beginning An error has occurred. See Section 2.9 for troubleshooting.
10.0 / 15.0	Yellow	On Blinking	Tape is recorded in 10.0 / 15.0 GB format Tape is recorded in another density, 10.0 / 15.0 GB has been selected for a WRITE from BOT.
20.0	Yellow	On Blinking	Tape is recorded in 20.0 GB format Tape is recorded in another density; 20.0 GB has been selected for a WRITE from BOT.
35.0	Yellow	On Blinking	Tape is recorded in 35.0 GB format Tape is recorded in another density; 35.0 GB has been selected for a WRITE from BOT.
40.0	Yellow	On Blinking	Tape is recorded in 40.0 GB format Tape is recorded in another density, 40.0 GB has been selected for a WRITE from BOT.
Compress	Yellow	On Off	Compression mode enabled (compression only valid for 10, 15, 20, or 35 GB densities only) Compression mode disabled
Density Override	Yellow	On Off	Operator selected a density from the density Select Button on the front panel and/or compression Density to be selected by the host (automatic)

Table 2-13 Tape System Operating Modes / Indicator Activity (continued)

Tape in Use Indicator and Modes

Whenever the yellow Tape in Use indicator is illuminated steadily, the tape system and cartridge are ready to use. When the system is calibrating, reading, writing, or rewinding the tape, the Tape in Use indicator blinks.

Table 2-14 explains each of the modes of the Tape in Use Indicator.

If the yellow Tape in Use Indicator is...	It means....
Illuminated, steadily	A cartridge is loaded in the tape system, but the tape is not moving. This may mean no application is communicating with the tape system's controller, or that the application is communicating but is not delivering any command that impact tape motion.
Blinking irregularly	A calibration, read, or write operation is in progress.
Blinking regularly	The tape is loading, unloading, or rewinding.
Off	No tape loaded in tape system.

Table 2-14 Tape in Use Indicator Modes

2.8. Using the DLT8000 Tape System's Basic Health Check (BHC) Test Feature

NOTE

The BHC feature is provided for use only by a trained service provider.

The BHC test uses the tape system's firmware to check the various EEROM-based information packets for log entries of events that have occurred in the previous 120 hours of operation. Based on that information, the system can report on its "health." The test is pass/fail only.

You can invoke the BHC test three ways: via the tape drive's front panel, the system's library port, or via the SCSI SEND DIAGNOSTIC command. This guide explains how to run the BHC test via the front panel; note that the BHC test cannot be run if a SEND DIAGNOSTIC command is in progress or if the BHC Test is already running.

Running the BHC Test Using the Front Panel

1. Press and **hold** the Density Select Button (Figure 13) for five seconds. The Density Override Indicator (Figure 2-13) flashes for five seconds. After the five seconds, the top two Density Indicators (Figure 2-13) will illuminate.
2. Release, then momentarily hold the Density Select Button. The top two Density Indicators will flash, indicating that the BHC test is running. The two Density Indicators continue to flash while the test proceeds.

NOTES

1. If the Density Select Button is pressed and held for fewer than five seconds, the BHC test will not run and the Density Indicators return to their original state.
2. If the Density Select Button is not released then momentarily pressed again, the BHC test will not run and the Density Indicators return to their original state.

*If the test **passes**, the top four Density Indicators illuminate steadily for five seconds, then return to their original state.*

*If the test **fails**, the top four Density Indicators flash on and off for five seconds, then return to their original state.*

2.9. Troubleshooting

Use Table 2-15 for troubleshooting tips in the event that your tape system fails its power-on self test or if it signals a problem via its front panel indicators.

If...	Then...	You Should...
System does not recognize the tape system	System may not be configured to recognize the SCSI ID.	Configure system to recognize the tape system's ID
	SCSI ID may not be unique	Change the SCSI ID and reconfigure the system. The new ID becomes effective at the next power on or SCSI bus reset.
	SCSI adapter parameters may not be correct	Check SCSI adapter documentation
	SCSI signal cable may be loose	Ensure SCSI cable is fully seated at each connector end
	SCSI terminator may be loose or not present on the bus	Ensure correct, secure termination of bus.
	SCSI bus may not be terminated correctly	If tape system is last or only device on bus (except for adapter), make sure terminator is installed on tape system. If tape system is not the last or only device on the bus, check the cable connections and ensure that the bus is properly terminated at each end.
	SCSI terminator may not be at end of bus or more than two terminators may be present	Ensure that a terminator is installed at each end of the bus. One terminator is usually installed at the host end of the bus.

Table 2-15 Troubleshooting Chart (continued)

If...	Then...	You Should...
System does not recognize the tape system (continued)	<ol style="list-style-type: none"> 1. SCSI bus may be too long. 2. Too many devices on the bus. 	<ol style="list-style-type: none"> 1. Limit bus length to ANSI SCSI standard for the SCSI interface being used. 2. Limit the number of devices on the bus (including the SCSI adapter) to match the limits of the interface being used.
The tape system does not power up	No power is reaching the tape system	Check the tape system's power cable connection at the rear of the system.
All right-hand or left-hand indicators on the tape system front panel are blinking	A system fault has occurred	Try to unload the tape and reinitialize the system by pressing the Unload button, or by turning power to the system off then back on. The indicators stop blinking as the system attempts reinitialization. The indicators illuminate steadily again, then extinguish if the test succeeds.
<p>CAUTION</p> <p>If this happens multiple times, contact your service representative.</p>		
Nonfatal or fatal errors occur for which the cause cannot be determined	<p>SCSI bus termination or the SCSI bus cable connections may be incorrect</p> <p>The ac power source grounding may be incorrect (tabletop version).</p>	<p>Ensure the SCSI bus is terminated and that all connections are secure.</p> <p>Use an ac outlet for the tabletop tape unit on the same ac line used by the host system.</p>

Table 2-15 Troubleshooting Chart (continued)

If...	Then...	You Should...
Indicators along right-hand side of front panel are blinking and the Operate Handle Light is illuminated steadily	The tape leader may be dropped.	Open the handle and look inside the tape system. If the tape leader is missing contact your service representative. Also, check the tape cartridges for damage.

Table 2-15 Troubleshooting Chart (continued)

If, after attempting the recommended actions listed in Table 2-14, the problem still exists or returns, a hardware failure may be the cause. Contact a service representative.

Refer to Appendix F for complete visual inspection instructions for DLTtape cartridges.

The web site <http://www.dlftape.com> includes much valuable information about DLTtape systems.

This Page Intentionally Left Blank

3. *SCSI Description*

This chapter provides a detailed description of the logical interfaces of the tape drive. The drive is fully compliant with the ANSI SCSI-2 standard for tape drive devices and implements many optional features

3.1. **SCSI Overview**

The Small Computer System Interface (SCSI) is a specification for a peripheral bus and command set that is an ANSI standard. The standard defines an I/O bus that supports up to 16 devices (wide SCSI).

ANSI defines three primary objectives of SCSI-2:

1. To provide host computers with device-independence within a class of devices
2. To be backward-compatible with SCSI-1 devices that support bus parity and that meet conformance level 2 of SCSI-1
3. To move device-dependent intelligence to the SCSI-2 devices

Important features of SCSI-2 implementation include the following:

- Efficient peer-to-peer I/O bus with up to 16 devices
- Asynchronous transfer rates that depend only on device implementation and cable length
- Logical addressing for all data blocks (rather than physical addressing)
- Multiple initiators and multiple targets
- Distributed arbitration (bus contention logic)
- Command queuing
- Command set enhancement

3.2. SCSI Commands

ANSI classifies SCSI commands as mandatory, optional, or vendor-specific. The mandatory and optional commands implemented for the drives are summarized in Table 3–1 and described fully in Chapter 5, SCSI Commands.

Command	Code	Class	Description
ERASE	19h	Mandatory	Causes part of all of the tape medium to be erased, beginning at the current position on the logical unit.
INQUIRY	12h	Mandatory	Requests that information about the tape drive be sent to the initiator.
LOAD UNLOAD	1Bh	Optional	Causes tape to move from not ready to ready. Prior to performing the load unload, the target ensures that all data, filemarks, and/or setmarks shall have transferred to the tape medium.
LOCATE	2Bh	Optional	Causes the target to position the logical unit to the specified block address in a specified partition. When complete, the logical position is before the specified position.
LOG SELECT	4Ch	Optional	Provides a means for the initiator to manage statistical information maintained by the drive about the drive. This standard defines the format of the log pages but does not define the exact conditions and events that are logged.
LOG SENSE	4Dh	Optional	Provides a means for the initiator to retrieve statistical information maintained by the drive about the drive.

Table 3–1 Implemented ANSI SCSI-2 Commands

Command	Code	Class	Description
MODE SELECT (6)	15h	Optional	Provides a means for the initiator to specify device parameters.
MODE SENSE (6)/(10)	1Ah/ 5Ah	Optional	Provides a means for a drive to report parameters to the initiator.
PREVENT ALLOW MEDIUM REMOVAL	1Eh	Optional	Requests that the target enable or disable the removal of the medium in the logical unit. Medium cannot be removed if any initiator has medium removal prevented.
READ	08h	Mandatory	Requests the drive to transfer data to the initiator.
READ BLOCK LIMITS	05h	Mandatory	Requests that the logical unit's block length limits capability be returned
READ BUFFER	3Ch	Optional	Used in conjunction with the WRITE BUFFER command as a diagnostic function for testing target memory and the integrity of the SCSI bus. This command does not alter the medium.
READ POSITION	34 h	Optional	Reports the current position of the logical unit and any data blocks in the buffer.
RECEIVE DIAG RESULTS	1Ch	Optional	Requests analysis data to be sent to the initiator after completion of a SEND DIAGNOSTIC Command.
RELEASE UNIT	17h	Mandatory	Used to release a previously reserved logical unit.
REQUEST SENSE	03h	Mandatory	Requests the drive to transfer sense data to the initiator.
RESERVE UNIT	16h	Mandatory	Used to reserve a logical unit.
SEND DIAGNOSTIC	1Dh	Mandatory	Requests the drive to perform diagnostic operations on itself.
SPACE	11h	Mandatory	Provides a selection of positioning functions (both forward and backward) that are determined by the code and count.

Table 3–1 Implemented ANSI SCSI-2 Command (continued)

Command	Code	Class	Description
TEST UNIT READY	00h	Mandatory	Provides a means to check if the logical unit is ready.
VERIFY	2Fh	Optional	Requests the drive to verify the data written to the medium.
WRITE	0Ah	Mandatory	Requests the drive to write the data transferred from the initiator to the medium.
WRITE BUFFER	3Bh	Optional	Used in conjunction with the READ BUFFER command as a diagnostic for testing target memory and the integrity of the SCSI bus.
WRITE FILEMARKS	10h	Mandatory	Requests that the target write the specified number of filemarks or setmarks to the current position on the logical unit.

Table 3–1 Implemented ANSI SCSI-2 Command (continued)

3.3. Signal States

The following paragraphs describe signal values and SCSI ID bits.

3.3.1. Signal Values

All signal values are actively driven true (low voltage). Because the signal drivers are OR-tied, the bus terminator's bias circuitry pulls false when it is released by the drivers at every SCSI device. If any device asserts a signal, (e.g., OR-tied signals), the signal is true. Table 3–2 shows the ANSI-specified and defined signal sources. Any device can assert RST at any time.

Bus Phase	Signals					
	BSY	SEL	C/D I/O MSG REQ	ACK ATN	DB(7–0) DB(P)	DB(15-8) DB(P1)
BUS FREE	None	None	None	None	None	None
ARBITRATION	All	Winner	None	None	S ID	S ID
SELECTION	I&T	Init	None	Init	Init	Init
RESELECTION	I&T	Targ	Targ	Init	Targ	Targ
COMMAND	Targ	None	Targ	Init	Init	None
DATA IN	Targ	None	Targ	Init	Targ	Targ
DATA OUT	Targ	None	Targ	Init	Init	Init
STATUS	Targ	None	Targ	Init	Targ	None
MESSAGE IN	Targ	None	Targ	Init	Targ	None
MESSAGE OUT	Targ	None	Targ	Init	Init	None

All: The signal is driven by all SCSI devices that are actively arbitrating.

SCSI ID: Each SCSI device that is actively arbitrating asserts its unique SCSI ID bit. The other seven (or fifteen) data bits are released. The parity bit (DB(P or P1) can be released or driven true, but is never driven false during this phase.

I&T: The signal is driven by the initiator, drive, or both, as specified in the SELECTION and RESELECTION phase.

Init: If driven, this signal is driven only by the active initiator.

None: The signal is released; that is, not driven by any SCSI device. The bias circuitry of the bus terminators pulls the signal to the false state.

Winner: The signal is driven by the winning SCSI device.

Targ: If the signal is driven, it is driven only by the active drive.

Table 3–2 Signal Sources

3.3.2 SCSI ID Bits

SCSI permits a maximum of eight SCSI devices on a SCSI bus (16 devices are permitted when using wide SCSI). Each SCSI device has a unique SCSI ID assigned to it. This SCSI ID provides an address for identifying the device on the bus. On the drive, the SCSI ID is assigned by configuring jumpers or connecting remote switches to the option connector. Chapter 2, *Hardware Implementation* has full instructions for setting the SCSI ID.

3.4. SCSI Signals

The following paragraphs define SCSI signals and bus timing values.

3.4.1. SCSI Signal Definitions

Table 3–3 defines the SCSI bus signals.

Signal	Definition
ACK (acknowledge)	A signal driven by the initiator as an acknowledgment of receipt of data from a target or as a signal to a target indicating when the target should read the data (out) lines.
ATN (attention)	A signal driven by an initiator to indicate that it has a message to send.
BSY (busy)	An OR-tied signal that indicates that the bus is in use.
C/D (control/data)	A signal driven by a target that indicates whether CONTROL or DATA information is on the DATA BUS. True (low voltage) indicates CONTROL.
DB(7–0,P) (data bus)	Eight data-bit signals, plus a parity-bit signal that form a DATA BUS. DB(7) is the most significant bit and has the highest priority (8 or 16-bit) during ARBITRATION. Bit number, significance, and priority decrease downward to DB(0). A data bit is defined as 1 when the signal value is true (low voltage) and 0 when the signal value is false (high voltage). Data parity DB(P) is odd. Parity is undefined during ARBITRATION.
DB(15–8,P1) (data bus)	Eight data-bit signals, plus one parity-bit signal, that forms an extension to the DATA BUS. They are used for 16-bit (wide) interfaces. DB(15) is the most significant bit and has the higher priority (but below bit DB(0) during ARBITRATION. Bit number, significance, and priority decrease downward to DB(8). Data Parity DB (P1) is odd.
I/O (input/output)	A signal driven by a target that controls the direction of data movement on the DATA BUS with respect to an initiator. True indicates input to the initiator. Also used to distinguish between SELECTION and RESELECTION modes.
MSG (message)	A signal driven by a target during the MESSAGE phase.
REQ (request)	A signal driven by a target to indicate a request for an information transfer to or from the initiator. Each byte of data transferred is accompanied with a REQ/ACK “handshake”. See also, ACK.

Table 3–3 SCSI-2 Bus Signal Definitions

Signal	Definition
RST (reset)	An OR-tied signal that initiates a RESET condition.
SEL (select)	An OR-tied signal used by an initiator to select a target or by a target to reselect an initiator.

Table 3–3 SCSI-2 Bus Signal Definitions (continued)

3.4.2. Signal Bus Timing

The ANSI SCSI-2 standard defines the SCSI bus timing values shown in Table 3–4.

Timing Description	Value	Description
Arbitration Delay	2.4 μ s	Minimum time a SCSI device waits from asserting BSY for arbitration until the DATA BUS can be examined to see if arbitration has been won; there is no maximum time.
Assertion Period	90 ns	Minimum time a drive asserts REQ while using synchronous data transfers; also, the minimum time that an initiator asserts ACK while using synchronous data transfers.
Bus Clear Delay	800 ns	Maximum time for a SCSI device to stop driving all bus signals after: <ol style="list-style-type: none"> BUS FREE is detected. SEL is received from another SCSI device during ARBITRATION. Transition of RST to true. <p>For condition 1, the maximum time for a SCSI device to clear the bus is 1200 ns (1.2 μs) from BSY and SEL first becoming both false.</p> <p>If a SCSI device requires more than a bus settle delay to detect BUS FREE, it clears the bus within a bus clear delay minus the excess time.</p>
Bus Free Delay	800 ns	Maximum time a SCSI device waits from its detection of BUS FREE until its assertion of BSY when going to ARBITRATION.
Bus Set Delay	1.8 μ s	Maximum time for a device to assert BSY and its SCSI ID bit on the DATA BUS after it detects BUS FREE to enter ARBITRATION.

Table 3–4 SCSI Bus Timing Values

Timing Description	Value	Description
Bus Settle Delay	400 ns	Minimum time to wait for the bus to settle after changing certain control signals as called out in the protocol definitions.
Cable Skew Delay	10 ns	Maximum difference in propagation time allowed between any two SCSI bus signals measured between any two SCSI devices.
Data Release Delay	400 ns	Maximum time for an initiator to release the DATA BUS signals following the transition of the I/O signal from false to true.
Deskew Delay	45 ns	Minimum time required to wait for all signals (especially data signals) to stabilize at their correct, final value after changing.
Disconnection Delay	200 μ s	Minimum time that a drive waits after releasing BSY before participating in an ARBITRATION when honoring a DISCONNECT message from the initiator.
Hold Time	45 ns	Minimum time added between the assertion of REQ or ACK and changing the data lines to provide hold time in the initiator or drive while using standard (slow) synchronous data transfers.
Negation Period	90 ns	Minimum time that a drive negates REQ while using synchronous data transfers; also, the minimum time than an initiator negates ACK while using synchronous data transfers. ¹
Power-On to Selection	10 s ¹	Recommended maximum time from power application until a drive is able to respond with appropriate status and sense data to the TEST UNIT READY, INQUIRY, and REQUEST SENSE commands.
Reset to Selection Time	250 ms ¹	Recommended maximum time after a hard RESET condition until a drive is able to respond with appropriate status and sense data to the TEST UNIT READY, INQUIRY, and REQUEST SENSE commands.
Reset Hold Time	25 μ s	Minimum time for which RST is asserted; there is no maximum time.
Selection Abort Time	200 μ s	Maximum time that a drive (or initiator) takes from its most recent detection of being selected (or reselected) until asserting a BSY response.
Selection Time-Out Delay	250 ms ¹	Recommended minimum time a SCSI device should wait for a BSY response during SELECTION or RESELECTION before starting the time-out procedure.

¹ Recommended Time.

Table 3-4 SCSI Bus Timing Values (continued)

Timing Description	Value	Description
Transfer Period ²		Minimum time allowed between the leading edges of successive REQ pulses and of successive ACK pulses while using standard or fast synchronous data transfers. The period range is 200 to 500ns minimum, standard, or 100 to 500ns minimum, fast-synchronous.

² Set during an SDTR message.

Table 3-4 SCSI Bus Timing Values (continued)

3.5. SCSI Bus Phases

The SCSI architecture includes eight distinct phases:

- BUS FREE phase
- ARBITRATION phase
- SELECTION phase
- RESELECTION phase
- COMMAND phase
- DATA phases (In/Out)
- STATUS phase
- MESSAGE phases (In/Out)

The last four phases are called the “information transfer phases.”

The SCSI bus can never be in more than one phase at any given time. In the following descriptions, signals that are not mentioned are not asserted.

3.5.1. *BUS FREE Phase*

The BUS FREE phase indicates that there is no current I/O process and that the SCSI bus is available for a connection.

SCSI devices detect the BUS FREE phase after the SEL and BSY signals are both false for at least one bus settle delay.

During normal operation, the BUS FREE phase is entered when the drive releases the BSY signal. However, the BUS FREE phase can be entered following the release of the SEL signal after a SELECTION or RESELECTION phase time-out. BUS FREE might be entered unexpectedly. If, for example, an internal hardware or firmware fault makes it unsafe for the tape drive to continue operation without a full reset (similar to a power-up reset), or if ATN is asserted or a bus parity error is detected during non-tape data transfers.

CAUTION

Any occurrence of a bus parity error (i.e., a single-bit error) should be considered serious: it implies the possibility of undetected double-bit error may exist on the bus. This may cause undetected data corruption. On properly configured SCSI buses, parity errors are extremely rare. If any are detected they should be addressed by improving the configuration of the SCSI bus. A well-configured SCSI bus in a normal environment should be virtually free of bus parity errors.

Bus parity errors cause the tape drive to retry the operation, go to the STATUS phase, or go to BUS FREE and prepare Sense Data. Retrying of parity errors during Data Out Phase when writing is normally not done, but can be enabled by changing the EnaParErrRetry parameter in the VU EEROM Mode Page. This feature is not enabled by default because of possible negative impact on device performance (the data stream on writes cannot be pipelined as well).

Initiators normally do not expect the BUS FREE phase to begin because of the drive's release of the BSY signal unless it has occurred after the detection of a reset condition or after a drive has successfully transmitted or received one of the following messages:

Messages Transmitted from Drive:

- DISCONNECT
- COMMAND COMPLETE

Messages Received by Drive:

- ABORT
- BUS DEVICE RESET
- RELEASE RECOVERY
- ABORT TAG
- CLEAR QUEUE

If an initiator detects the release of the BSY signal by the drive at any other time, the drive is indicating an error condition to the initiator. The drive can perform this transition to the BUS FREE phase independently of the state of the ATN signal. The initiator manages this condition as an unsuccessful I/O process termination. The drive terminates the I/O process by clearing all pending data and status information for the affected nexus. The drive can optionally prepare sense data that can be retrieved by a REQUEST SENSE command.

Bus Free Sequence

1. BSY and SEL signals are continuously false for one bus settle delay.
2. SCSI devices release all SCSI bus signals within one bus clear delay.
 - If a SCSI device requires more than one bus settle delay to detect the BUS FREE phase, then it releases all SCSI bus signals within one bus clear delay minus the excess time to detect the BUS FREE phase.
 - The total time to clear the SCSI bus cannot exceed one bus settle delay plus one bus clear delay.

3.5.2. ARBITRATION Phase

The ARBITRATION phase allows one SCSI device to gain control of the SCSI bus so that it can initiate or resume an I/O process.

The SCSI device arbitrates for the SCSI bus by asserting both the BSY signal and its own SCSI ID after a BUS FREE phase occurs.

Arbitration Sequence

1. The SCSI device waits for the BUS FREE phase to occur.
2. The SCSI device waits a minimum of one bus free delay after detection of the BUS FREE phase before driving any signal.
3. The SCSI device arbitrates for the SCSI bus by asserting the BSY signal and its SCSI ID.
4. The SCSI device waits at least an arbitration delay to determine arbitration results.

NOTE

Step 4 requires that every device complete the arbitration phase to the point of SEL being asserted (for a SELECTION or RESELECTION phase) to avoid hanging the bus.

- If a higher priority SCSI ID bit is true on the DATA BUS, the SCSI device loses the arbitration.
- The losing SCSI device releases the BSY signal and its SCSI ID bit within one bus clear delay after the SEL signal asserted by the arbitration winner becomes true.

- The losing SCSI device waits for the SEL signal to become true before releasing the BSY signal and SCSI ID bit when arbitration is lost.
- The losing SCSI device returns to Step 1. If no higher priority SCSI ID bit is true on the DATA BUS, the SCSI device wins the arbitration and asserts the SEL signal.
- The winning SCSI device waits at least one bus clear delay plus one bus settle delay after asserting the SEL signal before changing any signals.

3.5.3. SELECTION Phase

The SELECTION phase allows an initiator to select a drive to initiate a drive function.

The SCSI device that won the arbitration has both the BSY and SEL signals asserted and has delayed at least one bus clear delay plus one bus settle delay before ending the ARBITRATION phase. The SCSI device that won the arbitration becomes an initiator by not asserting the I/O signal.

During SELECTION, the I/O signal is negated so that this phase can be distinguished from the RESELECTION phase.

Selection Sequence

The initiator:

1. Sets the DATA BUS to the OR of its SCSI ID bit and the drive's SCSI ID bit.
2. Asserts the ATN signal (signaling that a MESSAGE OUT phase is to follow the SELECTION phase).
3. Waits at least two deskew delays.
4. Releases the BSY signal.
5. Waits at least one bus settle delay.
6. Looks for a response from the drive.

The drive:

7. Determines that it is selected when the SEL signal and its SCSI ID bit are true and the BSY and I/O signals are false for at least one bus settle delay.
8. Can examine the DATA BUS to determine the SCSI ID of the selecting initiator.
9. Asserts the BSY signal within a selection abort time of its most recent detection of being selected (this is required for correct operation of the selection time-out procedure).
 - The drive does not respond to a selection if bad parity is detected. Also, if more than two SCSI ID bits are on the DATA BUS, the drive does not respond to selection.

- Note that the initiator will release the SEL signal and may change the DATA BUS no less than two deskew delays after it detects that the BSY signal is true. The drive waits until the SEL signal is false before asserting the REQ signal to enter an information transfer phase. Other signals (e.g., MSG, C/D) may also be asserted.

Selection Time-Out

Two optional time-out procedures are specified for clearing the SCSI bus if the initiator waits a minimum of a selection time-out delay and there has been no BSY signal response from the drive.

1. The initiator asserts the RST signal.
2. The initiator follows these steps:
 - a) Continues asserting the SEL and ATN signals and releases the DATA BUS.
 - b) If it has not detected the BSY signal to be true after at least a selection abort time plus two deskew delays, the drive releases the SEL and ATN signals, allowing the SCSI bus to go to the BUS FREE phase.

When responding to selection, SCSI devices ensure that the selection was still valid within a selection abort time of their assertion of the BSY signal. Failure to comply with the requirement could result in an improper selection.

3.5.4. RESELECTION Phase

RESELECTION is an optional phase that allows a drive to reconnect to an initiator to continue an operation that was previously started by the initiator but was suspended by the drive.

The initiator determines that it is reselected when the SEL and I/O signals and its SCSI ID bit are true, and the BSY signal is false for at least one bus settle delay.

Reselection Sequence

The drive:

1. Upon completing the ARBITRATION phase, asserts both the BSY and SEL signals.
2. Delays at least one bus clear delay plus one bus settle delay.
3. Asserts the I/O signal.
4. Sets the DATA BUS to the logical OR of its SCSI ID bit and the initiator's SCSI ID bit.
5. Waits at least two deskew delays.
6. Releases the BSY signal.
7. Waits at least one bus settle delay before looking for a response from the initiator.

The initiator:

8. Determines that it is selected when the following occur for at least one bus settle delay: SEL, I/O, and the initiator's SCSI ID bit are true and BSY is false.
9. Examines the DATA BUS to determine the SCSI ID of the reselecting drive.
10. Asserts the BSY signal within a selection abort time of its most recent detection of being reselected.
 - The initiator does not respond to a RESELECTION phase if bad parity is detected or if more than two SCSI ID bits are on the DATA BUS.

The drive:

11. Detects the BSY signal is true.
 12. Asserts the BSY signal.
 13. Waits at least two deskew delays.
 14. Releases the SEL signal.
- The drive can then change the I/O signal and the DATA BUS.

The initiator:

15. Detects the SEL signal is false.
16. Releases the BSY signal.

The drive:

17. Continues asserting the BSY signal until it relinquishes the SCSI bus.

Reselection Time-Out

Two optional time-out procedures are specified for clearing the SCSI bus if the initiator waits a minimum of a selection time-out delay and there has been no BSY signal response from the drive.

1. The initiator asserts the RST signal.
2. The initiator follows these steps:
 - a) Continues asserting the SEL and ATN signals and releases the DATA BUS.
 - b) If it has not detected the BSY signal to be true after at least a selection abort time plus two deskew delays, releases the SEL and ATN signals, allowing the SCSI bus to go to the BUS FREE phase.

SCSI devices that respond to the RESELECTION phase must ensure that the reselection is still valid within a selection abort time of asserting the BSY signal.

3.5.5. Information Transfer Phases

NOTES

1. The tape drive supports wide asynchronous and synchronous data transfers.
2. Both differential and single-ended versions of the tape drive are available.
3. Odd parity is generated during all information transfer phases during which the device writes data to the SCSI bus, and parity is checked during all transfer phases in which data is read from the bus by the tape drive. Parity checking can be disabled (Chapter 2).
4. The ANSI SCSI specification refers to mini-libraries as "medium changers." In this chapter the term "mini-libraries" is used to describe these devices.
5. The DLT8000 supports block size of 1 byte to 16 Mbytes.
6. Disconnects from the SCSI bus are done at regular intervals during information transfer phases to allow other devices to access the bus. These disconnects are user-configurable via the Disconnect-Reconnect Page of the SCSI MODE SELECT command.

NOTES (CONTINUED)

7. The tape drive does not act as an initiator on the SCSI bus. Therefore, the drive does not 1) generate unsolicited interrupts to the bus, 2) initiate its own SCSI commands, and 3) assert bus reset.
8. A mini-library subsystem is assigned two logical unit numbers (LUNs): the tape drive is always LUN 0, and the mini-library component has a default LUN of 1, but may be reconfigured to any LUN from 0 to 15 via the SCSI MODE SELECT command.

The COMMAND, DATA, STATUS, and MESSAGE phases are known as the Information Transfer Phases because they are used to transfer data or control information.

The C/D, I/O, and MSG signals are used to distinguish between the different information transfer phases (Table 3–5). The drive asserts these three signals and so controls all information transfer phase changes. The drive can also cause a BUS FREE phase by releasing the MSG, C/D, I/O, and BSY signals. The initiator can request a MESSAGE OUT phase by asserting the ATN signal.

The information transfer phases use one or more REQ/ACK handshakes to control the information transfer. Each REQ/ACK handshake allows the transfer of one byte of information. During the information transfer phases, the BSY signal remains true and the SEL signal remains false. Additionally, the drive continuously envelopes the REQ/ACK handshake(s) with the C/D, I/O, and MSG signals in such a manner that these control signals are valid for one bus settle delay before the assertion of the REQ signal of the first handshake and remain valid after the negation of the ACK signal at the end of the handshake of the last transfer of the phase.

After the negation of the ACK signal of the last transfer of the phase, the drive can prepare for a new phase by asserting or negating the C/D, I/O, and MSG signals. These signals can be changed together or individually. They can be changed in any order and can be changed more than once (although each line should change only once). A new phase does not begin until the REQ signal is asserted for the first byte of the new phase.

A phase ends when the C/D, I/O, or MSG signal changes after the negation of the ACK signal. The time between the end of a phase and the assertion of the REQ signal beginning a new phase is undefined. An initiator is allowed to anticipate a new phase based on the previous phase, the expected new phase, and early information provided by changes in the C/D, I/O, and MSG signals. However, the anticipated phase is not valid until the REQ signal is asserted at the beginning of the next phase.

Information Transfer Direction

True I/O Signal: from drive to initiator

False I/O Signal: from initiator to drive

MSG	Signal		Phase Name	Direction of Transfer/ Definition
	C/D	I/O		
0	0	0	DATA OUT	Initiator to drive. Allows the drive to request that data be sent from the initiator to the drive.
0	0	1	DATA IN	Drive to initiator. Allows the drive to send data to the initiator.
0	1	0	COMMAND	Initiator to drive. Allows the drive to request a command from the initiator.
0	1	1	STATUS	Drive to initiator. Allows the drive to send status information be sent from the drive to the initiator.
1	1	0	MESSAGE OUT	Initiator to drive. Allows the drive to request that message(s) be sent from the initiator to the drive; the drive invokes this phase in response to the attention condition created by the initiator. The drive handshakes byte(s) until the ATN signal is negated, except when rejecting a message. See 3.5.5.4 <i>Message Out — Additional Conditions</i> .
1	1	1	MESSAGE IN	Drive to initiator. Allows the drive to send message(s) to the initiator.

Table 3–5 Information Transfer Phases

3.5.5.1. Asynchronous Data Transfer

Drive to Initiator Transfer Procedure

1. The drive drives the DB (0-15, P, & P1) signals to their desired values.
2. Drive delays at least one deskew delay plus a cable skew delay.
3. Drive asserts the REQ signal.
4. Initiator reads the DB (0-15, P, & P1) signals.
5. Initiator indicates its acceptance of the data by asserting the ACK signal.
6. When ACK is true at the drive, drive can change or release the DB (0-15, P, & P1) signals.
7. Drive negates the REQ signal.
8. Initiator negates the ACK signal.
9. Drive can continue the transfer by driving the DB (0-15, P, & P1) signals and asserting the REQ signal (Steps 1 – 3).

Initiator-to-Drive Transfer Procedure

1. Drive asserts the REQ signal.
2. Initiator drives the DB (0-15, P, & P1) signals to their desired values.
3. Initiator delays at least one deskew delay plus a cable skew delay.
4. Initiator asserts the ACK signal.
5. When ACK is true at the drive, drive reads the DB (0-15, P, & P1) signals.
6. Drive negates the REQ signal.
7. Initiator can change or release the DB (0-15, P, & P1) signals.
8. Initiator negates the ACK signal.
9. Drive can continue the transfer by asserting the REQ signal (Step 1).

3.5.5.2. Synchronous Data Transfer

Synchronous Data Transfer is optional and is only used in DATA phases and only if a synchronous data transfer agreement is established. The REQ/ACK offset specifies the maximum number of REQ pulses that can be sent by the drive in advance of the number of ACK pulses received from the initiator, establishing a pacing mechanism. If the number of REQ pulses exceeds the number of ACK pulses by the REQ/ACK offset, the drive does not assert the REQ signal until after the leading edge of the next ACK pulse is received. For successful completion of the data phase, the number of ACK and REQ pulses must be equal.

The initiator sends one ACK signal pulse for each REQ pulse received. The ACK signal can be asserted as soon as the leading edge of the corresponding REQ pulse has been received.

Drive-to-Initiator Transfer Procedure

1. The drive sets the DB (7–0, P) signals to the desired values. The DB (0-15, P, & P1) signals are held valid for a minimum of one deskew delay plus one cable skew delay after REQ is asserted.
2. Drive delays at least one deskew delay plus a cable skew delay.
3. Drive asserts the REQ signal for a minimum of one assertion period. Drive can negate the REQ signal and change or release the DB (0-15, P, & P1) signals.
4. Initiator reads the DB (0-15, P, & P1) signals within one hold time of the transition of the REQ signal to true.
5. Initiator indicates its acceptance of the data by asserting an ACK pulse.
6. The drive waits at least the greater of these periods before again asserting REQ:
 - a) A transfer period from the last transition of the REQ signal to true, or
 - b) A negation period from the last transition of the REQ signal to false.
7. The initiator waits at least the greater of these periods before reasserting ACK:
 - a) A transfer period from the last transition of the ACK signal to true, or
 - b) A negation period from the last transition of the ACK signal to false.

Initiator-to-Drive Transfer Procedure

Initiator transfers one byte for each REQ pulse received.

1. Drive asserts the REQ signal.
2. After receiving the leading edge of the REQ signal, initiator drives the DB (0-15, P, & P1) signals to their desired values. The DB (0-15, P, & P1) signals are held valid for at least one deskew delay plus one cable skew delay plus one hold time delay after the assertion of the ACK signal.
3. Initiator delays at least one deskew delay plus a cable skew delay.
4. Initiator asserts the ACK signal for a minimum of one assertion period.
5. Initiator can negate the ACK signal and change or release the DB (0-15, P, & P1) signals.
6. Drive reads the DB (0-15, P, & P1) signals within one hold time of the transition of the ACK signal to true.
7. The drive waits at least the greater of these periods before again asserting the REQ signal:
 - a) A transfer period from the last transition of the REQ signal to true, or
 - b) A negation period from the last transition of the REQ signal to false.
8. The initiator waits at least the greater of the following periods before again asserting the ACK signal:
 - a) A transfer period from the last transition of the ACK signal to true, or
 - b) A negation period from the last transition of the ACK signal to false.

3.5.5.3. Signal Restrictions Between Phases

When the SCSI bus is between two information transfer phases, the following restrictions apply to the SCSI bus signals:

- The BSY, SEL, REQ, and ACK signals do not change.
- The C/D, I/O, MSG, and DATA BUS signals can change.
- When changing the DATA BUS direction from out (initiator-driving) to in (drive-driving), the drive delays driving the DATA BUS by at least a data release delay plus one bus settle delay after asserting the I/O signal. The initiator releases the DATA BUS no later than a data release delay after the transition of the I/O signal to true.
- When switching the DATA BUS from in to out, the drive releases the DATA BUS no later than a deskew delay after negating the I/O signal.
- The ATN and RST signals can change as defined under the descriptions for the attention condition (Section 3.6.1) and reset condition (Section 3.6.2).

3.5.5.4. STATUS Phase

The tape drive enters the status phase just once per command unless a retry is requested by the initiator. The only exception is during error cases when the device goes immediately to bus free, as defined in the ANSI SCSI-2 specification.

Status bytes the tape drive can return are as follows:

Status Bytes Returned from Tape Drive	Definition
GOOD (00h)	This status indicates that the drive successfully completed the command.
CHECK CONDITION (02h)	A contingent allegiance condition occurred. The REQUEST SENSE command should be sent following this status to determine the nature of the event.
BUSY (08h)	Target is busy. This status is returned whenever the device is unable to accept a command from an otherwise acceptable initiator. The initiator should reissue the command at a later time.
INTERMEDIATE GOOD (10h)	This status is returned instead of GOOD for commands issued with the LINK bit set = 1. Following the return of this status, the drive proceeds to the COMMAND phase for the transfer of the next linked command.
RESERVATION CONFLICT (18h)	This status is returned by the drive whenever a SCSI device attempts to access the drive when it has been reserved for another initiator with a RESERVE UNIT command.
COMMAND TERMINATED (22h)	This status is returned for a command that was terminated via a TERMINATE I/O PROCESS message. This status also indicates that a contingent allegiance condition has occurred.

NOTE

In contrast to the BUSY status condition, the DRIVE NOT READY Sense Key is returned as part of the Sense data following a REQUEST SENSE command and indicates that a media access command has been issued but that the media is not ready to be accessed (for example, the tape cartridge is not installed, the tape medium has been unloaded, the tape drive is currently initializing the tape medium to prepare it for access, etc.).

In the DRIVE NOT READY state, the initiator cannot perform any operation that would cause tape motion (READ, WRITE, VERIFY, for example). These commands return a CHECK CONDITION status with a DRIVE NOT READY sense key. The initiator may execute commands that do not require tape motion or access to the tape medium, and a GOOD status may be the result.

3.6. SCSI Bus Conditions

The SCSI bus has two asynchronous conditions: Attention and Reset.

3.6.1. Attention Condition

The attention condition informs a drive that an initiator has a message ready. The drive gets the message by performing a MESSAGE OUT phase. The attention condition requires the following timing:

- The initiator creates the attention condition by asserting ATN at any time except during the ARBITRATION or BUS FREE phases.
- The initiator negates the ATN signal at least two deskew delays before asserting the ACK signal while transferring the last byte of the message.
- If the drive detects that the initiator failed to meet this requirement, then the drive goes to BUS FREE.
- Before transition to a new bus phase, the initiator asserts the ATN signal, then waits at least two deskew delays before negating the ACK signal for the last byte transferred in the current bus phase. Asserting the ATN signal later cannot be honored until a later bus phase and then cannot result in the expected action.

The drive responds with MESSAGE OUT as described in the following table.

ATN Signal True in Phase...	The Drive Enters MESSAGE OUT...
COMMAND	After transferring part or all of the command descriptor block bytes.
DATA	At the drive's earliest convenience (often on a logical block boundary). The initiator continues REQ/ACK handshakes until it detects the phase change.
STATUS	After the status byte has been acknowledged by the initiator.
MESSAGE IN	Before it sends another message. This permits a MESSAGE PARITY ERROR message from the initiator to be associated with the appropriate message.
SELECTION ¹	Immediately after that SELECTION phase.
RESELECTION ²	After the drive has sent its IDENTIFY message for that RESELECTION phase.

¹ Before the initiator releases BSY, provided the initiator asserted ATN

² The initiator should only assert the ATN signal during a RESELECTION phase to transmit a BUS DEVICE RESET or DISCONNECT message.

Table 3–6 Drive MESSAGE OUT Phase Response

The initiator keeps the ATN signal asserted if more than one byte is to be transferred. The initiator can negate the ATN signal at any time, except it does not negate the ATN signal while the ACK signal is asserted during a MESSAGE OUT phase. Normally, the initiator negates the ATN signal while the REQ signal is true and the ACK signal is false during the last REQ/ACK handshake of the MESSAGE OUT phase.

3.6.2. Reset Condition

The tape drive responds to power-on and/or bus reset conditions as described:

- All tape drive SCSI lines assert high impedance when the tape drive is powered off.
- The drive does not generate any spurious signals on the SCSI bus when the drive is powered on.
- Within five (5) seconds of power-on, and within 250 milliseconds (typically under 4 milliseconds) after a bus reset, the tape drive responds to SCSI bus selections and returns the appropriate normal responses. Tape motion commands are returned with Check Condition status, Sense Key of Not Ready, until the medium has been made ready.
- The tape medium is rewound to Beginning of Partition (BOP, i.e., Beginning of Tape [BOT]).

Note that the tape drive does not implement the hard reset alternative for bus RESET processing.

The tape drive recognizes multiple bus resets in succession as well as bus resets of arbitrarily long duration (powering on conditions). It recovers within the time limits specified above following the last bus reset.

3.6.3. Queued Unit Attentions

Queued Unit Attentions are implemented on the tape drive and are maintained separately for each valid LUN for each initiator. Unit Attentions are created as a result of the following circumstances:

- Power on
- Bus reset
- Bus device reset message
- When the media may have changed asynchronously
- When another initiator has changed the mode parameters
- When a firmware (microcode) update has completed

Two (2) queued Unit Attentions are not unusual. For example, if a drive is powered up and a cartridge is loaded, “power up” and “not ready to ready transition” Unit Attention messages are created. Due to a limited number of Unit Attention buffers, if an initiator does not clear Unit Attentions queued for it, the tape drive at some point stops generating new Unit Attention messages for the Initiator-Logical Unit (I-L) combination (existing messages remain queued).

A LOAD command does not generate a Unit Attention message for the initiator that issued the command, since the transition to ready is synchronous.

This Page Intentionally Left Blank

4. Messages

The SCSI message system allows communication between an initiator and the drive for interface management and command qualification. Messages can be originated by either the initiator or the drive. This section contains a detailed description of the messages supported by the disk drives.

4.1. Message Format

A message can be one or more bytes in length. One or more messages can be sent during a single MESSAGE phase, but a message cannot be split over MESSAGE phases. The initiator is required to end the MESSAGE OUT phase (by negating ATN) when it sends certain messages that are identified in Table 4–2.

When a connection to the drive is established (i.e., the drive is selected with ATN asserted), the first message byte passed by the initiator must be either an IDENTIFY, ABORT, or BUS DEVICE RESET message. If not, the drive discards the message, saves no status information, and goes to the BUS FREE phase.

If an initiator supplies an unsupported message (for example, COMMAND COMPLETE or a reserved or undefined message code), the drive returns a MESSAGE REJECT message and continues where it left off (possibly returning to MESSAGE OUT if ATN is raised).

The first byte of the message, as defined in Table 4–1, determines the format of the message.

Message Code	Message
00h	One-byte message (COMMAND COMPLETE)
01h	Extended message
02h – 1Fh	One-byte message
20h – 2Fh	Two-byte message
40h – 7Fh	Reserved
80h – FFh	One-byte message (IDENTIFY)

Table 4–1 Message Format

The DLT8000 tape drive supports the messages listed in Table 4–2. The message code and the direction of the message flow is also included in the table (In = target to initiator, Out = initiator to target).

Message	Message Code	Direction	
ABORT	06h		Out
BUS DEVICE RESET	0Ch		Out
COMMAND COMPLETE	00h	In	
DISCONNECT	04h	In	Out
EXTENDED MESSAGE (SDTR and wide Data Transfer Request) *	01h	In	Out
IDENTIFY	80h – FFh	In	Out
IGNORE WIDE RESIDUE	23h	In	
INITIATOR DETECTED ERROR	05h		Out
LINKED COMMAND COMPLETE	0Ah	In	
LINKED COMMAND COMPLETE (with flag)	0Bh	In	
MESSAGE PARITY ERROR	09h		Out
MESSAGE REJECT	07h	In	
NO OPERATION	08h		Out
RESTORE POINTERS	03h	In	
SAVE DATA POINTER	02h	In	
WIDE DATA TRANSFER REQUEST *	03h	In	Out

* **Extended messages (Figure 4–1).**

Table 4–2 Supported Messages

Two-byte messages consist of two consecutive bytes. The value of the first byte, as defined in Table 4–1, determines which message is to be transmitted. The second byte is a parameter byte that is used as defined in the message description.

A value of 1 in the first byte indicates the beginning of a multiple-byte extended message. The minimum number of bytes sent for an extended message is three. The extended message format is shown in Figure 4–1 and the data fields are described in Table 4–3.

Bit	7	6	5	4	3	2	1	0
Byte								
0	Extended Message (01h)							
1	Extended Message Length							
2	Extended Message Code							
3 to n - 1	Extended Message Arguments							

Figure 4-1 Extended Message — Data Format

Field	Description
Extended Message Length	This field specifies the length, in bytes, of the Extended Message Code plus the Extended Message Arguments that follow. Therefore, the total length of the message is equal to the Extended Message Length plus 2. A value of 0 for the Extended Message Length indicates that 256 bytes follow.
Extended Message Code	The drive supports three Extended Messages. They are: 00h MODIFY DATA POINTER 01h SYNCHRONOUS DATA TRANSFER REQUEST 03h WIDE DATA TRANSFER REQUEST

Table 4-3 Extended Message — Field Description

4.2. Supported SCSI Messages

Following are descriptions of each of the messages supported by the drive.

4.2.1. **ABORT Message (06h)**

This message is sent from the initiator to the target to clear the current I/O process on the selected unit. Buffered (cached) write operations are completed if possible. The target goes directly to the BUS FREE phase after successful receipt of this message. Current settings of MODE SELECT parameters and reservations are not affected. Commands, data, and status for other initiators is not affected.

This message can be sent to a logical unit that is not currently performing an operation for the initiator. If no unit has been selected, the target goes to BUS FREE phase and no commands, data, or status on the target are affected.

4.2.2. **BUS DEVICE RESET Message (0Ch)**

The BUS DEVICE RESET message is sent from an initiator to direct the drive to clear all I/O processes on the drive. The message causes the drive to:

1. Flush the contents of cache to tape and go to the BUS FREE phase.
2. Execute a hard reset, leaving it as if a Bus Reset had occurred.

The drive creates a Unit Attention condition for all initiators after accepting and processing a Bus Device Reset message. The additional sense code is set to POWER ON, RESET, or BUS DEVICE RESET OCCURRED.

4.2.3. **COMMAND COMPLETE Message (00h)**

The COMMAND COMPLETE message is sent by the drive to an initiator to indicate that an I/O process has completed and that valid status has been sent to the initiator. After successfully sending this message, the drive goes to the BUS FREE phase by releasing the BSY signal. The drive considers the message transmission successful when it detects the negation of ACK for the COMMAND COMPLETE message with the ATN signal false. If a COMMAND COMPLETE message is received by the tape drive, it is handled as an illegal message: the drive returns MESSAGE REJECT and enters its STATUS phase, reporting CHECK CONDITION with the sense key set to COMMAND ABORTED.

4.2.4. **DISCONNECT Message (04h)**

The DISCONNECT message is sent from the drive to inform the initiator that the present connection is going to be broken (the drive plans to disconnect by releasing the BSY signal) and a later reconnect will be required to complete the current I/O process. The message does not cause the initiator to save the data pointer. After sending the message, the drive goes to the BUS FREE phase by releasing the BSY signal.

The DISCONNECT message can also be sent by the initiator to tell the drive to suspend the current phase and disconnect from the bus. The drive's response to and its handling of a DISCONNECT message are based on when, in the I/O process, the initiator introduces the DISCONNECT message. Table 4–4 summarizes the drive's response.

BUS Phase	Drive Response
SELECTION	The drive discards the DISCONNECT message and goes to BUS FREE.
COMMAND	The drive discards the DISCONNECT message and goes to BUS FREE. The ATTENTION request is ignored while the Command Descriptor Block is fetched. The drive does not switch to MESSAGE OUT until the current DMA completes.
DATA	The ATTENTION request is ignored while the current data transfer completes; that is, the drive does not switch to MESSAGE OUT until after the current DMA completes. The drive returns a MESSAGE REJECT message and responds with CHECK CONDITION status, indicating the command aborted because of an invalid message.
STATUS	The drive sends a MESSAGE REJECT message, then sends COMMAND COMPLETE.
MESSAGE IN	The drive sends a MESSAGE REJECT message and switches to the BUS FREE phase.

Table 4–4 Drive Response to DISCONNECT Message

4.2.5. IDENTIFY Message (80h - FFh)

The IDENTIFY message is sent by either the initiator or the drive to establish or re-establish the physical connection path between an initiator and target for a particular logical unit, under the conditions listed below. Figure 4–2 shows the format of the IDENTIFY message and Table 4–5 describes the data field contents.

Bit	7	6	5	4	3	2	1	0
	Identify	DiscPriv	LUNTAR	Reserved		LUNTRAN		

Figure 4–2 IDENTIFY Message — Data Format

Field	Description
Identify	The Identify bit must be set to 1. This identifies the message as an IDENTIFY message.
DiscPriv	Disconnect Privilege. The DiscPriv can be 0, provided that no other I/O process is currently active in the drive. If not set to 1 and other I/O processes are currently active in the drive, the drive returns BUSY status.
LUNTAR	The Logical Unit/Target Routine (LUNTAR) field must be set to zero. The drive supports a single Logical Unit Number (LUN 0). A LUNTAR bit of one causes the drive to send a MESSAGE REJECT message and switch to the BUS FREE phase.
Reserved	The Reserved bits must be zero. If a Reserved bit is non-zero, the drive returns a MESSAGE REJECT message and switches to the BUS FREE phase.
LUNTRN	Logical Unit Number.

Table 4–5 IDENTIFY Message — Field Description

4.2.6. IGNORE WIDE RESIDUE Message (23h)

The IGNORE WIDE RESIDUE message is sent by the target to the initiator to indicate that the number of valid bytes sent during the last REQ/ACK handshake and REQ/ACKB handshake of a DATA IN phase is less than the negotiated transfer width. The Ignore field indicates the number of invalid data bytes transferred. This message is sent immediately following that DATA IN phase and prior to any other messages. Figure 4-3 illustrates the data format of an IGNORE WIDE RESIDUE message. Table 4-6 describes the Ignore field bit definitions.

Bit	7	6	5	4	3	2	1	0
Byte								
0	Message Code (23h)							
1	Ignore (01h)							

Figure 4–3 IGNORE WIDE RESIDUE Message — Data Format

Ignore	<u>Invalid Data Bits</u> 16-bit Transfers
00h	Reserved
01h	DB(15-8)
02h - FFh	Reserved

Table 4–6 IGNORE WIDE RESIDUE Message — Field Definition

4.2.7. **INITIATOR DETECTED ERROR Message (05h)**

The INITIATOR DETECTED ERROR message is sent from an initiator to inform the drive that an error has occurred that does not preclude the drive from retrying the operation (a bus parity error, for example). The source of the error may either be related to previous activities on the SCSI bus or may be only drive-related. When received, the tape drive attempts to re-transfer the last command, data, or status bytes by using the RESTORE POINTER message mechanism.

The drive's response to and its handling of an INITIATOR DETECTED ERROR message are based on when, in the I/O process, the initiator introduces the message. Table 4-7 summarizes the drive's response.

BUS Phase	Drive Response
SELECTION	The drive discards the INITIATOR DETECTED ERROR message and then goes to the BUS FREE phase.
COMMAND	The drive discards any Command Descriptor Block bytes fetched from the initiator, sets the Sense Key to ABORTED COMMAND, sets the Additional Sense Code to INITIATOR DETECTED ERROR MESSAGE RECEIVED. It sends the CHECK CONDITION status and the COMMAND COMPLETE message and then goes to the BUS FREE phase.
DATA	The drive discards the INITIATOR DETECTED ERROR message and sets the Sense Key to ABORTED COMMAND, sets the Additional Sense Code to INITIATOR DETECTED ERROR MESSAGE RECEIVED. It sends the CHECK CONDITION status and the COMMAND COMPLETE message and then goes to the BUS FREE phase.
STATUS	The drive sends a RESTORE POINTERS message, returns to the STATUS phase, resends the STATUS command, and continues the I/O process.
MESSAGE IN	The drive discards the INITIATOR DETECTED ERROR message and sets the Sense Key to ABORTED COMMAND, sets the Additional Sense Code to INITIATOR DETECTED ERROR MESSAGE RECEIVED. It sends the CHECK CONDITION status and the COMMAND COMPLETE message and then goes to the BUS FREE phase.

Table 4-7 Drive Response to INITIATOR DETECTED ERROR Message

4.2.8. LINKED COMMAND COMPLETE Message (0Ah)

This message is sent from a target to an initiator to indicate that the execution of a linked command (with the FLAG bit set to zero) is complete and that status has been sent. The initiator then sets the pointers to the initial state for the next command.

If received by a target, this message is handled as an illegal message; the drive enters the MESSAGE IN phase and returns MESSAGE REJECT.

4.2.9. LINKED COMMAND COMPLETE, with Flag Message (0Bh)

This message is sent from a target to an initiator to indicate that the execution of a linked command (with the FLAG bit set to one) is complete and that status has been sent.

4.2.10. MESSAGE PARITY ERROR Message (09h)

This message is sent from the initiator to tell the drive that the last message byte the drive passed on to the initiator contained a parity error.

To indicate that it intends to send the message, the initiator sets the ATN signal before it releases ACK for the REQ/ACK handshake of the message that has the parity error. This provides an interlock so that the target can determine which message has the parity error. If the target receives this message under any other condition, it proceeds directly to the BUS FREE state by releasing the BSY signal, signifying a catastrophic error.

The target's response to this message is to switch to the MESSAGE IN phase and re-send from the beginning all the bytes of the message that precipitated the MESSAGE PARITY ERROR message.

4.2.11. MESSAGE REJECT Message (07h)

This message is sent from the initiator or target to indicate that the last message received was inappropriate or has not been implemented.

To indicate its intention to send this message, the initiator asserts the ATN signal before it releases ACK for the REQ/ACK handshake of the message that is to be rejected. MESSAGE REJECT is issued in response to any message the drive considers to be illegal or not supported. When sending to the initiator, the tape drive does so before requesting any additional message bytes.

4.2.12. NO OPERATION (08h)

If a target requests a message, the initiator sends a NO OPERATION message if it does not currently have any other valid message to send. The message is accepted when the drive is acting as a target and may be sent when it is an initiator. If a NO OPERATION message is received during a selection, the drive proceeds to the COMMAND phase (provided ATN does not continue as asserted); the NO OPERATION message is ignored by the tape drive.

4.2.13. RESTORE POINTERS Message (03h)

The RESTORE POINTERS message is sent from the drive to the initiator to direct the initiator to copy the most recently saved command, data, and status pointers for the I/O process to the corresponding current pointers. The command and status pointers are restored to the beginning of the present command and status areas. The data pointer is restored to the value at the beginning of the data area in the absence of a SAVE DATA POINTER message or to the value at the point at which the last SAVE DATA POINTER message occurred for that logical unit.

When the RESTORE POINTERS message is received as a target, the target switches to the message in phase and returns MESSAGE REJECT.

4.2.14. SAVE DATA POINTER Message (02h)

The SAVE DATA POINTER message is sent from the drive to direct the initiator to copy the current data pointer to the saved data pointer for the current I/O process.

When functioning as a target, the tape drive sends this message before a disconnect during a data transfer. It does not send a SAVE DATA POINTER message if it intends to move directly to STATUS phase. When received as a target, it switches to message in phase and returns MESSAGE REJECT.

4.2.15. **SYNCHRONOUS DATA TRANSFER REQUEST Message (01h)**

NOTE

The tape drive supports initiating synchronous transfer negotiations with the host, but this feature is disabled by default. To enable it, set the MODE SELECT VU ERROM parameter EnalnitSyncNeg.

This extended message allows the target and initiator to agree on the values of the parameters relevant to synchronous transfers. The tape drive will not initiate the Synchronous Data Transfer Request message; it relies on the initiator to do so. The Synchronous Data Transfer Request command has the format shown in Figure 4-4.

Bit	7	6	5	4	3	2	1	0
Byte								
0	Extended Message Identifier (01h) (see Figure 4-1)							
1	Length (03h)							
2	Message Code (01h)							
3	Transfer Period: Min. = 25 (19h) (equals 100 ns)							
4	Transfer REQ/ACK Offset: Max. = 15							

Figure 4-4 Synchronous Data Transfer Request Message — Data Format

4.2.16. **WIDE DATA TRANSFER REQUEST Message (03h)**

The following figure illustrates the message formats.

Bit	7	6	5	4	3	2	1	0
Byte								
0	Extended Message Identifier (01h) (see Figure 4-1)							
1	Extended Message Length (02h)							
2	WIDE DATA TRANSFER REQUEST (03h)							
3	Transfer Width Exponent							

Figure 4–5 Wide Data Transfer Request Message — Data Format

A WIDE DATA TRANSFER REQUEST Message exchange is initiated by a SCSI device whenever a previously arranged transfer width agreement may have become invalid. The agreement becomes invalid after any condition that may leave the data transfer agreement in an indeterminate state such as

- After a hard reset condition
- After a BUS DEVICE RESET Message
- After a power cycle.

The WIDE DATA TRANSFER REQUEST Message exchange establishes an agreement between two SCSI devices on the width of the data path to be used for DATA phase transfer between them. This agreement applies to DATA IN and DATA OUT phases only. All other information transfer phases must use an 8-bit data path.

The DLT8000 tape drive implements both wide data transfer option and synchronous data transfer option. It negotiates the wide data transfer agreement prior to negotiating the synchronous data transfer agreement. If a synchronous data transfer agreement is in effect, then after accepting a WIDE DATA TRANSFER REQUEST message, it resets the synchronous agreement to asynchronous mode.

The transfer width is two the transfer width exponent bytes wide. The transfer width that is established applies to all logical units. Valid transfer widths for the DLT8000 tape drive are 8 bits (m = 00h) and 16 bits (m = 01h). Values of m greater than 01h are reserved.

This Page Intentionally Left Blank

5. SCSI Commands

This chapter describes the SCSI protocol features implemented in the DLT8000 tape system. Note that the sections included in this chapter do not fully reiterate every ANSI SCSI message, option, and/or command code specification; the sections do describe the supported commands, messages, options, and error recovery procedures.

5.1. SCSI COMMANDS

The Tandberg DLT8000 tape system supports the SCSI commands listed in Table 5–1. The subsection of this chapter that details each of the SCSI commands is listed in the “Subsection” column.

Command	Operation Code	Subsection
ERASE	19h	5.3
INQUIRY	12h	5.4
LOAD UNLOAD	1Bh	5.5
LOCATE	2Bh	5.6
LOG SELECT	4Ch	5.7
LOG SENSE	4Dh	5.8
MODE SELECT (6 / 10)	15h / 55h	5.9
MODE SENSE (6 / 10))	1Ah / 5Ah	5.10
PERSISTENT RESERVATION IN	5Eh	5.11
PERSISTENT RESERVATION OUT	5Fh	5.12
PREVENT ALLOW MEDIUM REMOVAL	1Eh	5.13
READ	08h	5.14
READ BLOCK LIMITS	05h	5.15
READ BUFFER	3Ch	5.16
READ POSITION	34h	5.17
RECEIVE DIAGNOSTIC RESULTS	1Ch	5.18
RELEASE UNIT (6)	17h	5.19
RELEASE UNIT (10)	57h	5.20
REPORT DENSITY SUPPORT	44h	5.21

(continued)

Table 5–1 Supported SCSI Commands

Command	Operation Code	Subsection
REPORT LUNS	A0h	5.22
REQUEST SENSE	03h	5.23
RESERVE UNIT (6)	16h	5.24
RESERVE UNIT (10)	56h	5.25
REWIND	01h	5.26
SEND DIAGNOSTIC	1Dh	5.27
SPACE	11h	5.28
TEST UNIT READY	00h	5.29
VERIFY	13h	5.30
WRITE	0Ah	5.31
WRITE BUFFER	3Bh	5.32
WRITE FILEMARKS	10h	5.33

Table 5–1 Supported SCSI Commands (continued)

NOTES

1. Relative Addressing is not supported by the tape drive. Therefore, in all I/O commands, the RelAdr bit must be 0.
2. RESERVE UNIT and RELEASE UNIT by Logical Unit Number are supported, as are third-party reservations. Extent reservations are not supported.
3. The RECEIVE DIAGNOSTIC RESULTS and SEND DIAGNOSTIC DATA commands implement vendor-unique pages to test the drive during the manufacturing process. It is recommended that initiators specify only the non-page format variants of these commands (PF=0), except for page 0x40.
4. The DLT tape drive does not act as an initiator on the SCSI bus. Therefore, the drive will not 1) generate unsolicited interrupts to the host, 2) initiate its own SCSI commands, or 3) assert bus reset.
5. Linked commands are supported.

5.1.1. SCSI Pointers

SCSI architecture provides a set of three pointers (called saved pointers) for each I/O process. The three pointers are: Command, Status, and Data. When an I/O process becomes active, the three saved pointers are copied to the initiator as current pointers. There is only one set of current pointers in the initiator at one time. The current pointers point to the next command, data, or status byte to be transferred between the initiator's memory and the drive. The saved and current pointers reside in the initiator.

The saved command pointer always points to the start of the Command Descriptor Block for the I/O process. The saved status pointer always points to the start of the status area of the I/O process. The saved data pointer always points to the start of the data area until the drive sends a SAVE DATA POINTER message for the I/O process back to the initiator.

In response to the SAVE DATA POINTER message, the initiator stores the value of the current data pointer into the saved data pointer for that I/O process. The drive can restore the current pointer from the saved pointer value for the active I/O process by sending a RESTORE POINTERS message to the initiator. The initiator then copies the set of saved pointers into the set of current pointers. Whenever a drive disconnects from the SCSI Bus, only the set of saved pointers is retained in the initiator. The set of current pointers is restored from the set of saved pointers when the I/O process is reconnected.

5.1.2. Command Descriptor Block

An initiator communicates with the drive by sending a 6- or 10-byte Command Descriptor Block that contains the parameters for the specific command. The SCSI command's operation code is always the first byte in the Command Descriptor Block and a control field is the last byte. For some commands, the Command Descriptor Block is accompanied by a list of parameters sent during the DATA OUT phase. Figure 5–1 shows the format of a typical 6-byte Command Descriptor Block. Table 5–2 contains a description of the Command Descriptor Block fields.

Bit Byte	7	6	5	4	3	2	1	0
0	Operation Code							
1	Logical Unit Number (LUN)			Logical Block Address (LBA) (MSB)				
2 - 3	Logical Block Address (LBA) (LSB)							
4	Transfer Length, Parameter List Length, or Allocation Length							
5	Control							

NOTE: Unless otherwise specified, all reserved bits indicated in the commands are 0. The Control byte is described on Page 5-6.

Figure 5–1 Typical 6-Byte Command Descriptor Block — Data Format

Field	Description
Operation Code	The operation code specifies the command being requested. The list of supported SCSI commands and their operation codes are contained in Table 5–1.
Logical Unit Number	The Logical Unit Number contains the number of the device being addressed. It must be set to 0. The Logical Unit Number is ignored if the Command Descriptor Block is preceded by an IDENTIFY Message.
Logical Block Address	Commands that require additional parameter data specify the length of the Logical Block Address that is needed. See the specific command descriptions for more detailed information. The drive does not support Relative Addressing: it defaults to a value of 0 which specifies that the Logical Block Address specifies the first logical block of a range of logical blocks to be operated on by the command. Relative Addressing indicates a technique used to determine the next Logical Block Address to be operated on.,
Transfer Length	The transfer length field normally specifies the number of blocks to be transferred between the initiator and the drive. For several commands, the transfer length indicates the number of bytes (not blocks) to be sent. For these commands, this field may be identified by a different name.
Parameter List Length	The Parameter List Length is used to specify the number of bytes sent during the DATA OUT phase. This field is typically used for parameters that are sent to a drive (for example, mode, diagnostic, and log parameters). A parameter list length of 0 indicates that no data is to be transferred.
Allocation Length	This field specifies the maximum number of bytes that the initiator has allocated for returning data. The host uses this field to limit the size of data transfers to its own internal buffer size.
Control Field	The Control Field is the last byte of every command descriptor block. Its format is shown in Figure 5–2, and it contains the Flag and Link bits. Use of these bits is initiator-dependent. Setting the Link bit = 1 provides an automatic link to the next command, bypassing the usual ARBITRATION, SELECTION, and MESSAGE OUT phases that would normally occur between commands. Other bits in the Control Field are considered to be reserved.
Relative Address (RelAdr)	Must be 0 (not supported).

Table 5–2 Command Descriptor Block — Field Descriptions

The final byte of the CDB is called the *Control* byte. Its contents are defined in the next figure and table. In the remainder of this chapter, the Flag and Link bytes will not be redefined each time they appear as part of a command.

Byte	7	6	5	4	3	2	1	0
---	Unused		Reserved				Flag	Link

Figure 5–2 Command Descriptor Block Control Field — Data Format

Field	Description
Unused	Bits 6 & 7 of the Control Byte are reserved for vendor-specific use. They are not used by this tape drive, so the values in each of these bits is always 0.
Flag	The Flag bit is used in conjunction with the Link bit to notify the initiator in an expedient manner that a command has been completed.
Link	A Link bit set to 1 indicates that the initiator requests continuation of a task (an I/O process) across two or more SCSI commands. If the Link bit is 1 and the Flag bit is 0, and the task completes successfully, the drive continues the task and returns a status of INTERMEDIATE and a LINKED COMMAND COMPLETE message. If the Link bit and the Flag bit within a Control word are both set to 1, and the drive completes a command with a status of INTERMEDIATE, the drive returns a LINKED COMMAND COMPLETE message (with Flag).

Table 5–3 Command Descriptor Block Control Field — Field Descriptions

5.1.3. Status/Error Reporting

SCSI message-level errors are communicated by messages that are defined specifically for that purpose (for example, MESSAGE PARITY ERROR, MESSAGE REJECT). Message-level errors are also handled by drive-managed retries. Refer to Chapter 4 for more detailed message-handling information.

SCSI command-level errors are communicated by a status code that is returned by the drive during the STATUS phase. This phase occurs at the end of each command, unless the command is terminated by one of the following events:

- ABORT message
- BUS DEVICE RESET message
- Hard reset condition
- Unexpected disconnect

The status code is contained in bits 1 through 5 of the status byte. Bits 0, 6, and 7 are reserved. Table 5–4 describes the status codes returned by the drive.

Status Code	Definition	Meaning
00h	GOOD	The drive successfully completed the command.
02h	CHECK CONDITION	A Contingent Allegiance condition occurred.
08h	BUSY	The drive cannot service the command at the moment, and its Command Descriptor Block has been discarded. The initiator can retry the command at a later time.
10h	INTERMEDIATE GOOD	This status is returned instead of a GOOD status for commands issued with the LINK bit set. Following the return of this status, the drive proceeds to the COMMAND phase for the transfer of the next linked command.
18h	RESERVATIONCONFLICT	Another initiator has reserved the drive when it has been reserved for another initiator with a RESERVE UNIT command (this status is never returned for INQUIRY or REQUEST SENSE commands).

Table 5–4 Status Codes

NOTE

In contrast to the BUSY status condition, the DRIVE NOT READY Sense Key is returned as part of the Sense data following a REQUEST SENSE command and indicates that a media access command has been issued and the medium is not ready to be accessed (for example, the medium is not installed, the medium has been unloaded, the drive is currently initializing the medium to prepare it for access).

5.1.4. DATA-Phase Command Components

Many of the SCSI commands cause data to be transferred between the initiator and the drive. The content and characteristics of this data are command-dependent. Table 5–5 lists the information transmitted for all of the commands.

The "Length in CDB" column of Table 5–5 identifies the Command Descriptor Block field used by the drive to determine how much command-related data are to be transferred. The units (bytes or logical blocks) for the different Length fields are implied by the Length Field Name as follows:

<u>Field Name</u>	<u>Units Implied</u>
Allocation Length	Bytes of data the drive is allowed to send to the initiator
Parameter List Length	Bytes of data the initiator has available for the drive
Transfer Length	Logical number of data blocks or data bytes the initiator wants transferred or verified
Byte Transfer Length	Bytes of data the initiator wants transferred

The DATA OUT column in Table 5–5 lists the information passed to the drive by the initiator as part of the command. The DATA IN column lists the information sent to the initiator by the drive. Numbers in parentheses after an item indicate the item's length in bytes. In some cases, additional length information is communicated during the DATA phase.

Command	Length in CDB	Data Out (To Drive)	Data In (To Initiator)
ERASE	0		
INQUIRY	Allocation	---	Standard Inquiry or a Vital Product Data page
LOAD UNLOAD	0	---	---
LOCATE	0	---	---
LOG SELECT	Parameter List (must be 0)	---	---
LOG SENSE	Allocation	---	Log Page
MODE SELECT (6) / (10)	Parameter List	Mode Parameter Header (4) Block Descriptor (8) Page(s)	---
MODE SENSE (6) / (10)	Allocation	---	Mode Parameter Header (4) Block Descriptor (8) Page(s)
PERSISTENT RESERVATION IN	Allocation	---	Parameter Data
PERSISTENT RESERVATION OUT	Parameter Length	Parameter List	---
PREVENT ALLOW MEDIUM REMOVAL	0	---	---
READ	Transfer	---	Data
READ BLOCK LIMITS	Allocation	---	Block Length Limits
READ BUFFER	Allocation	---	Buffer Offset and Allocation Length
READ POSITION	Allocation	---	Position Identifier or SCSI Logical Address
RECEIVE DIAGNOSTIC RESULTS	Allocation	---	Diagnostic Page
RELEASE UNIT	0	---	---
REPORT DENSITY SUPPORT	Allocation	---	Density Support Header (4), Density Support Descriptors

(continued)

Table 5-5 DATA-Phase Command Contents

Command	Length in CDB	Data Out (To Drive)	Data In (To Initiator)
REPORT LUNS	Allocation	---	Supported LUNS List
REQUEST SENSE	Allocation	---	Sense Data (18)
RESERVE UNIT	0 (Extent List Option not supported)	---	---
REWIND	0	---	---
SEND DIAGNOSTIC	Parameter List	Diagnostic Page	---
SPACE	0	---	---
TEST UNIT READY	0	---	---
VERIFY	Transfer	Data	---
WRITE	Transfer	Data	---
WRITE BUFFER	Parameter List	Microcode Image Data	---
WRITE FILEMARKS	---	---	---

Table 5-5 DATA-Phase Command Contents (continued)

5.1.5. Unit Attention Condition

Queued Unit Attentions are implemented on the Tandberg DLT8000 tape drive and are maintained separately for each valid LUN for each initiator. Unit Attentions are created in each of the following circumstances:

- At Power On
- At Bus Reset
- At Bus Device Reset message
- When the medium may have changed asynchronously
- When another initiator changes the Mode Parameters
- When a firmware (microcode) update has completed

Two queued Unit Attentions are not unusual. For example, if a unit is powered up and a tape cartridge is loaded, Power Up and Not-Ready to Ready Transition Unit Attentions are created. Due to the limited number of Unit Attention buffers, if an initiator does not clear Unit Attentions queued for it, at some point the tape drive stops generating new Unit Attentions for that initiator-logical unit combination (existing ones will be left queued, however).

A LOAD command does not generate a Unit Attention for the initiator that issued the command since the transition to Ready is synchronous.

5.1.6. Behavior At Power-On and SCSI Bus Reset

The following apply to the DLT8000 tape drive's behavior at power-on and/or SCSI bus reset:

- When the Tandberg DLT8000 system is powered up, all device SCSI lines are set to high impedance.
- The design of the DLT8000 tape drive does not allow it to generate any spurious signals on the SCSI bus at power-on.
- Within five seconds of power-on, and within 250 milliseconds (typically under 4 milliseconds) after a SCSI bus reset, the DLT8000 tape drive responds to SCSI bus selections and returns appropriate, normal responses. Tape motion commands will be returned with Check Condition status, Sense Key Not Ready, until the tape medium has been made ready.
- The tape drive implements the hard bus reset option.
- The tape medium is rewound to Beginning of Tape (BOT).

The DLT8000 tape drive recognizes multiple, successive SCSI bus resets and SCSI bus resets of arbitrarily long duration. The tape drive recovers within the time limits specified above following the last SCSI bus reset.

The tape drive goes through a calibration process at power up and loading of medium.

5.1.7. **Data Cache and Tape Write Interaction**

The Tandberg DLT8000 system tape drive contains a data cache that buffers blocks (records) until they are written to tape. This section describes when those blocks are written, or “flushed” to tape. A Mode Select parameter allows the data cache to be disabled (unbuffered mode). In this mode, every WRITE command causes data to be written to the tape medium before the STATUS byte and the COMMAND COMPLETE message are returned to the host.

NOTE

Unbuffered mode is NOT recommended due to the poor performance that may result.

The contents of the write data cache are written to the tape medium under the following circumstances:

- When two or more WRITE FILEMARKS commands are issued without intervening tape motion commands.
- When a WRITE 0 FILEMARKS command is issued.
- When data has been in the cache longer than the maximum time specified by the value of the Mode Parameter “Write Delay Time” (the default is 20 seconds).
- When a non-write type media access command is received (for example, SPACE, READ, UNLOAD, LOCATE, ERASE).

5.2. SCSI-command Descriptions in This Manual

The SCSI commands are presented in alphabetical order. Each command starts on a new, odd-numbered page. Because information about a particular command may span multiple pages, the command name is repeated, in italics, at the top of every page that concerns that command. Blank pages in the chapter can be used for note-taking.

The SCSI command descriptions that make up the rest of Chapter 5 contain detailed information about each command supported by the Tandberg DLT8000 system tape drive. Fields common to many of the SCSI commands are supported as follows:

Name of Field:	How Field is Supported in SCSI Commands:
Logical Unit Number	LUN for tape drive is 0.
Reserved	Reserved bits, fields, bytes, and code values are set aside for future standardization and must be set to 0. If the drive receives a command that contains non-zero bits in a reserved field or a reserved code value, the command is terminated with a CHECK CONDITION status and the sense key is set to ILLEGAL REQUEST.
RelAdr	Relative Address. Unused; contents should be 0.

Explanations for those common fields are not repeated for every command in which they appear.

Throughout this manual, multiple bytes that contain information about specific command parameters are portrayed as shown in the example of the Parameter List Length field (bytes 7 and 8) of the Log Select command shown below:

Bit	7	6	5	4	3	2	1	0	
Byte									
(Bytes 0 - 6)									
7 - 8	Parameter List Length							(MSB)	(LSB)

As shown, this sample indicates that the most significant bit (MSB) of the field is bit 7 of byte 7; the least significant bit is bit 0 of byte 8.

This is an alternate, “shorthand” presentation for:

Bit	7	6	5	4	3	2	1	0
Byte								
(Bytes 0 - 6)								

7	Parameter List Length							(MSB)
8								(LSB)

The shorthand version of presentation is used in this manual due to space constraints.

5.3. ERASE Command (19h)

The ERASE command causes data on the tape medium to be erased.

NOTE
ERASE command MUST be issued while at BOT.

Bit	7	6	5	4	3	2	1	0
Byte								
0	Operation Code (19h)							
1	Logical Unit Number			Reserved			Immed	Long (1)
2	Reserved							
3	Reserved							
4	Reserved							
5	Unused	Reserved				Flag	Link	

Figure 5–3 ERASE Command Descriptor Block — Data Format

ERASE Command (19h) (continued)

Field	Description
Immed	Immediate. If the Immediate bit = 0, the target does not return status until the selected operation has completed. If set to 1, status is returned as soon as the operation has been initiated.
Long	Must be set to 1. The Long bit controls the distance of tape to be erased.

NOTE

The ERASE command results in no operation for the tape drive unless the Long bit is set to 1. Issuing the ERASE command away from Beginning of Tape (BOT) is an ILLEGAL REQUEST.

Table 5–6 ERASE Command Descriptor Block — Field Descriptions

5.4. INQUIRY Command (12h)

The INQUIRY command allows the initiator to determine the kind of SCSI devices attached to its SCSI bus. It causes a device that is attached to a SCSI bus to return information about itself. The drive identifies itself as a Direct Access Storage Device that implements the applicable interfacing protocol. The drive does not need to access its storage medium to respond to the inquiry.

The drive can provide two categories of data in response to an INQUIRY command: Standard Inquiry Data and Vital Product Data. Standard Inquiry Data contains basic data about the drive, and Vital Product Data comprises several pages of additional data. Each Vital Product Data page requires a separate INQUIRY command from the initiator.

An INQUIRY command is not affected by, nor does it clear, a Unit Attention condition.

Bit Byte	7	6	5	4	3	2	1	0
0	Operation Code (12h)							
1	Reserved						CmdDt	EVPD
2	Page Code or Operation Code							
3	Reserved							
4	Allocation Length							
5	Unused	Reserved					Flag	Link

Figure 5-4 INQUIRY Command Descriptor Block — Data Format

INQUIRY Command (12h) (continued)

Field	Description
CmdDt	Command Support Data. If CmdDt = 0 and EVPD (see below) = 0, the drive returns the Standard Inquiry Data. If CmdDt = 1 with EVPD = 0, the drive returns the Command Data specified by Page Code/Operation. Information about Command Support Data is provided in Figure 5-12 and Table 5-13.
EVPD	Enable Vital Product Data. If EVPD = 0 and CmdDt (see above) = 0, the drive returns the Standard Inquiry Data. If EVPD = 1 and CmdDt = 0, the drive returns the Vital Product Data Page specified by Page Code/Operation Code.
Page Code or	Specifies the Vital Product Data Page or Command Support Data which is to be returned by the drive when EVPD is set.
Operation Code	Specifies the SCSI Operation Code for command support data to be returned by the drive when CmdDt is set. A CHECK CONDITION status is returned if this field specifies an unsupported Page or Operation Code or if both EVPD and CmdDt are set.
Allocation Length	Specifies the number of bytes of inquiry information the drive is allowed to return to the initiator during the command's data-in buffer transfer. Error status is not returned if the value in this field truncates the requested information.

*Table 5-7 INQUIRY Command Descriptor Block — Field Descriptions***5.4.1. Standard Inquiry Data Page**

Figure 5-5 shows the format of the Standard Inquiry Data page returned by the drive.

INQUIRY Command (12h) (continued)

Bit	7	6	5	4	3	2	1	0
Byte								
0	Peripheral Qualifier			Peripheral Device Type				
1	RMB	Device Type Modifier						
2	ISO Version		ECMA Version			ANSI Version		
3	AENC	TrmIOP	Reserved		Response Data Format			
4	Additional Length = 33h							
5	Reserved							
6	Rsv'd	MChngr	Reserved					
7	RelAdr	Wbus32	Wbus16	Sync	Linked	Rsv'd	CmdQue	SftRe
8 - 15	Vendor Identification (TANDBERG)							
16 - 31	Product Identification (DLT8000)							
32 - 35	Product Revision Level (hhss)							
36 - 55	Vendor Unique Bytes							

Figure 5-5 Standard Inquiry Data Page — Data Format

INQUIRY Command (12h) (continued)

Table 5–8 contains field descriptions for the data returned by the drive.

Field Name	Value	Description
Peripheral Qualifier	0	Non-zero if initiator selects an invalid logical unit (see below)
Peripheral Device Type	1	1 indicates that this is a sequential access device (see below). Note that the Peripheral Device Type entry for a medium changer is 8.
RMB	1	Removable Medium Bit. Set to 1.
Device Type Modifier	1	Set to 1 to specify a sequential access device.
ISO Version	0	International Standardization Organization Version level. Set to 0.
ECMA Version	0	European Computer Manufacturers Organization Version level. Set to 0.
ANSI Version	2	ANSI SCSI Level 2 (SCSI-2) is supported.
AENC	0	Asynchronous Event Notification is not supported.
TrmIOp	0	Terminate I/O Process. The tape drive does not support the TERMINATE I/O PROCESS message.
Response Data Format	2	This Standard Inquiry Data is in SCSI-2 format.
Additional Length	33h	Tape drive uses this field to indicate the number of additional bytes of INQUIRY Response Data available.
Mchngr	-	Set to 1 if a Media Changer (Loader) is present and EEPROM parameter EnBlngMedChgr is set to 1. This SCSI-3 bit indicates that the Read Element Status and Move Medium commands can be issued to the drive (LUN0). By default, this bit is set to 0 on the DLT8000 drive.
RelAdr	0	Relative Addressing is not supported.
WBus 32	0	Set to 0 since the drive does not support 32-bit transfer.
WBus 16	1	The WBus bit is 1 since the drive supports 16-bit data transfer.
Sync	1	The drive supports Synchronous Data Transfers.
Linked	1	Linked Commands are supported.
CmdQue	0	The drive does not support Tagged Command Queuing.
SftRe	0	The drive implements the hard reset option in response to assertion of the SCSI Bus reset line.
Vendor Identification		The value in this field is TANDBERG (there is one space after the word Tandberg)
Product Identification		The value in this field is DLT8000 (there is no space between “DLT” and “8000” and one space after “DLT8000”)

Table 5–8 Standard Inquiry Data Page — Field Descriptions

INQUIRY Command (12h) (continued)

Field Name	Value	Description
Product Revision Level		This field contains 4 bytes of ASCII data that provides the drive's firmware revision levels. The first two bytes are the version number of servo code. The second two bytes are the version number of the SCSI/read/write code. When a firmware update is performed on the DLT drive, this part of the firmware revision level will change to reflect that update (quotation marks will not appear).
Vendor Specific		See Section 5.4.2 for details.

NOTE: Vendor Information, Product Identification, and Product Revision Level are returned as shown in Figure 5-6.

Table 5-8 Standard Inquiry Data Page — Field Descriptions (continued)

*INQUIRY Command (12h) (continued)***5.4.2. Vendor Unique Inquiry Data**

The following information can be used to precisely identify the revision of subsystem components.

Bit	7	6	5	4	3	2	1	0
Byte								
36	Product Family (8)				Released Firmware			
37	Firmware Major Version #							
38	Firmware Minor Version #							
39	EEPROM Format Major Version #							
40	EEPROM Format Minor Version #							
41	Firmware Personality							
42	Firmware Sub-Personality							
43	Vendor Unique Subtype							
44	Controller Hardware Version #							
45	Drive EEPROM Version #							
46	Drive Hardware Version #							
47	Media Loader Firmware Version #							
48	Media Loader Hardware Version #							
49	Media Loader Mechanical Version #							
50	Media Loader Present Flag							
51	Library Present Flag							
52 - 55	Module Revision							

Figure 5–6 INQUIRY Vendor Unique Bytes Definitions

INQUIRY Command (12h) (continued)

Field Name	Description														
Product Family	This field indicates the data density of each of the DLT tape drives as follows: <table border="1" data-bbox="473 366 940 574"> <thead> <tr> <th>Product Family Bit</th> <th>Drive Density</th> </tr> </thead> <tbody> <tr> <td>0</td> <td>Not Specified</td> </tr> <tr> <td>3</td> <td>10.0 / 20.0 GB</td> </tr> <tr> <td>5</td> <td>20.0 / 40.0 GB</td> </tr> <tr> <td>6</td> <td>15.0 / 30.0 GB</td> </tr> <tr> <td>7</td> <td>35.0 / 70.0 GB</td> </tr> <tr> <td>8</td> <td>40.0 / 80.0 GB</td> </tr> </tbody> </table>	Product Family Bit	Drive Density	0	Not Specified	3	10.0 / 20.0 GB	5	20.0 / 40.0 GB	6	15.0 / 30.0 GB	7	35.0 / 70.0 GB	8	40.0 / 80.0 GB
Product Family Bit	Drive Density														
0	Not Specified														
3	10.0 / 20.0 GB														
5	20.0 / 40.0 GB														
6	15.0 / 30.0 GB														
7	35.0 / 70.0 GB														
8	40.0 / 80.0 GB														
... Version #	This flag differentiates between released and test versions of firmware. When set to 1, indicates released code (Vxxx); 0 indicates field test code (Txxx). Released code has no minor firmware version number (byte 38 = 0). Field test and engineering versions of code have non-zero minor firmware version numbers for tracking purposes.														
Vendor Unique Subtype	These field display the various version numbers in binary, not ASCII														
Vendor Unique Subtype	Identification of product.														
Firmware Personality	Numeric indicator of firmware personality. Note that when set to 4, this indicates OEM family.														
Firmware Subpersonality	Set to 1, indicating standard SCSI device firmware.														
Loader Present	Set to 0 indicates no loader present. Non-zero indicates loader is present.														
Library Present	Set to 0 indicates no library present. Non-zero indicates library is present.														
Module Revision	A four byte ASCII string representing the revision level of the tape drive's module (the controller PCBA attached to the tape drive).														

Table 5–9 Vendor Unique Inquiry Data Page — Field Descriptions

5.4.3. Supported Vital Product Data Pages and Command Support Data

The Supported Vital Product Data Pages page (Figure 5–7) provides a directory of the Vital Product Data Pages that are supported by the drive. The supported pages are:

- The Unit Serial Number Page (80h)
- The Device Identification Page (83h)
- The Firmware Build Information Page (C0h)
- The Subsystem Components Revision Page (C1h, reserved for use by Tandberg Data)

In addition, if the CmdDt bit in the INQUIRY command is set to 1, then the drive returns command data as illustrated in Figure 5–12 and described in Table 5–13.

Bit	7	6	5	4	3	2	1	0
Byte								
0	Peripheral Qualifier			Peripheral Device Type				
1	Page Code (00h)							
2	Reserved							
3	Page Length (4 or more bytes)							
4	00h - (this page)							
5	80h - Unit Serial Number Page							
6	83h – Device Identification Page (Vendor Specific)							
7	C0h - Firmware Build Information Page (Vendor Specific)							
8	C1h – Subsystem Components Revision Page (For Tandberg Data Use Only; Page Content is Subject to Change)							

Figure 5–7 Supported Vital Product Data Pages Page — Data Format

*INQUIRY Command (12h) (continued)***The Unit Serial Number Page (80h)**

Bit	7	6	5	4	3	2	1	0
Byte								
0	Peripheral Qualifier			Peripheral Device Type				
1	Page Code (80h)							
2	Reserved							
3	Page Length (0Ah)							
4 - 13	Serial Number							

Figure 5–8 Unit Serial Number Page — Data Format

Field Name	Description
Serial Number	The serial number given is the serial number of the module or the drive typically starting with “CX” indicating the site of manufacture. If the drive serial number is valid, then it is reported; otherwise, the module serial number is reported. The serial number can be found on the bar code label. The serial number is returned in ASCII.

Table 5–10 Unit Serial Number Page — Field Descriptions

*INQUIRY Command (12h) (continued)***The Device Identification Page (83h)**

Bit	7	6	5	4	3	2	1	0
Byte								
0	Peripheral Qualifier			Peripheral Device Type				
1	Page Code (83h)							
2	Reserved							
3	Page Length (n-3)							
4 - n	Identification Descriptors							

Figure 5–9 Device Identification Page — Data Format

There are three different Device Identification Descriptors returned, in numerical order of the Identifier Type. Each Identification Descriptor takes the following form:

Bit	7	6	5	4	3	2	1	0
Byte								
0	Reserved			Code Set				
1	Reserved		Association		Identifier Type			
2	Reserved							
3	Page Length (n-3)							
4 - n	Identification Descriptors							

Figure 5–10 Identification Descriptor — Data Format

INQUIRY Command (12h) (continued)

Field Name	Description			
Code Set	The value in this field indicates the type of data to be found in the Identifier field.			
	<u>Code</u> <u>Meaning</u>			
	1 Binary data			
	2 ASCII data			
Association	The value in this field indicates whether the Identifier is associated with the logical unit (LUN) or the port. The default for this field = 0, designating associating with the LUN.			
Identifier Type	Types of identifiers allowed are:			
	<u>Value</u>	<u>Description</u>		
	1	Concatenation of the Vendor Name, Product ID, and unit serial number		
	2	Canonical form of the IEEE Extended Unique Identifier, 64 bit (EUI-64)		
	3	FC-PH Name_Identifier		
Identifier	The value in this field indicates the Identifier, based on Identifier Type:			
	<u>Identifier Type</u>	<u>Code Set</u>	<u>Length</u>	<u>Identifier</u>
	1	2	24	Tandberg DLT8000, 7 ASCII space characters (20h), followed by unit serial number in ASCII
	2	1	8	8 Bytes of binary data indicating the EUI-64 assigned to the drive
	3	1	8	8 Bytes of binary data indicating the 64-bit, Type 5, FC-PH Name_Identifier assigned to the drive

Table 5–11 Identifier Descriptor — Field Descriptions

*INQUIRY Command (12h) (continued)***The Firmware Build Information Page (VU) (C0h)**

Bit Byte	7	6	5	4	3	2	1	0
0	Peripheral Qualifier			Peripheral Device Type				
1	Page Code (C0h)							
2	Reserved							
3	Page Length (20h)							
4 - 5	Servo Firmware Checksum							
6 - 7	Servo EEPROM Checksum							
8 - 11	Read/Write Firmware Checksum							
12 - 35	Read/Write Firmware Build Data							

Figure 5–11 Firmware Build Information Page — Data Format

Field Name	Description
... Checksum	Servo Firmware, Servo EEPROM, and READ/WRITE Firmware checksums are given as binary numbers and are for positive firmware and EEPROM identification.
Firmware Build Date	Firmware Build Date is an ASCII string in the DD-MMM-YYYY HH:MM:SS format.

Table 5–12 Firmware Build Information Page — Field Descriptions

INQUIRY Command (12h) (continued)

The Subsystem Components Revision Page (C1h)

This page contains information used by Tandberg Data ASA about firmware, drive controller, and other DLT8000 tape drive components. It is reserved for use by Tandberg Data ASA and should not be used for other purposes.

*INQUIRY Command (12h) (continued)***Command Support Data**

An application client can request command support data by setting the CmdDt bit of the INQUIRY command to 1, and specifying the SCSI operation code of the Command Descriptor Block (CDB) for which it wants information.

Format of the command support data and definitions of the fields follow.

Bit	7	6	5	4	3	2	1	0
Byte								
0	Peripheral Qualifier			Peripheral Device Type				
1	Reserved					Support		
2	ISO Version		ECMA Version			ANSI-Approved Version		
3 – 4	Reserved							
5	CDB Size (m – 5)							
6 – m	(MSB) CDB Usage Data (LSB)							

Figure 5–12 Command Support Data Page — Data Format

INQUIRY Command (12h) (continued)

Field	Description
Support	The value of the Support field describes the type of support that the tape drive provides for Command Support Data. Value Description
	000b Data about the requested SCSI operation code is not currently available. In this case, all data after Byte 1 is undefined.
	001b The device does not support the SCSI operation code requested. In this case, all data after Byte 1 is undefined
	010b Reserved
	011b The device supports the SCSI operation code in conformance with the SCSI standard.
	100b Vendor-Specific
	101b The device supports the SCSI operation code, but in a vendor-specific manner
	110b Vendor-Specific
	111b Reserved
ISO-Version	Must be 0.
ECMA-Version	Must be 0.
ANSI-Approved Version	Minimum operating definition for supported command.
CDB Size	This field contains the number of bytes in the CDB for the Operation Code being requested and the size of the CDB Usage Data in the data that is returned in response to the INQUIRY.
CDB Usage Data	This field contains information about the CDB for the Operation Code being queried. Note that the first byte of the CDB Usage Data contains the OpCode for the operation specified. All of the other bytes of the CDB Usage Data contain a map for bits in the CDB of the OpCode specified.

*Table 5-13 Command Support Data Page — Field Descriptions***NOTE**

The bits in the map have a 1-to-1 correspondence to the CDB for the OpCode being queried. That is, if the device senses a bit as the entire field or as part of the field of the operation, the map in CDB Usage Data contains a 1 in the corresponding bit position. If the device ignores a bit or declares a bit as “reserved” in the CDB for the OpCode being queried, the map has a 0 in that corresponding bit position.

5.5. LOAD UNLOAD Command (1Bh)

The LOAD UNLOAD command tells the target to load or unload the tape media in the tape cartridge. If no cartridge is in the tape drive, both LOAD and UNLOAD return a CHECK CONDITION status with a NOT READY sense key set. Likewise, if the drive has received an UNLOAD command with the Immediate bit set and then it receives another command that would require tape motion or if it receives a TEST UNIT READY command, the drive returns a CHECK CONDITION STATUS with a NOT READY sense key set.

NOTE

Operation of the UNLOAD version of this command is different if a media loader is present.

Two modes of operation are possible if a media loader is configured. If none of the media loader-specific commands have been issued, the device operates in the sequential mode of operation described below. Once a media loader-specific command has been issued, however, the sequential mode of operation (described below) is disabled and the UNLOAD command becomes a NO OPERATION.

If the tape drive is in the default sequential mode of operation and an UNLOAD command is received by the subsystem, the current cartridge is unloaded and automatically moved to the magazine slot from which it was received. The cartridge from the next magazine slot (if the slot is not empty) automatically moves from the magazine into the drive, is loaded, and made ready. If the next magazine slot is empty, no CHECK CONDITION status is created.

When the cartridge is unloaded into the last magazine slot, the subsystem does not cycle back to slot 0. This prevents accidental overwriting of data when using a media loader subsystem in sequential auto-loading mode. The next cartridge in the cycle must be selected and loaded manually, or with a SCSI MOVE MEDIUM command.

The sequential loading feature of the loader can be enabled/disabled by modifying the ENALDRAUTOLD and DISLDRAUTOLD parameters of EEPROM (mode page 3Eh of the MODE SELECT command).

A media loader does not affect the tape drive's processing of the LOAD portion of the LOAD UNLOAD command.

LOAD UNLOAD Command (1Bh) (continued)

Bit Byte	7	6	5	4	3	2	1	0
0	Operation Code (1Bh)							
1	Logical Unit Number			Reserved				Immed
2	Reserved							
3	Reserved							
4	Reserved					EOT	Re-Ten	Load
5	Unused		Reserved				Flag	Link

Figure 5–13 LOAD UNLOAD Command Descriptor Block — Data Format

LOAD UNLOAD Command (1Bh) (continued)

Field Name	Description
Immed	Immediate. If this bit is set to 1, status is returned as soon as the operation is started. If set to 0, status is returned after the operation has completed.
Re-Ten	Re-tension. Re-tension operations are not needed on the tape drive. This bit is ignored (i.e., "good" status, if bit is set to 1).
Load	<p>Load. When a cartridge is inserted, the tape medium is automatically loaded and positioned by the drive at Beginning of Medium (BOM). Logically, the drive is positioned at the beginning of Partition 0.</p> <p>If the Load bit is set to 1, and the medium is already loaded, no action is taken. A "good" status is returned. If the medium was unloaded but the cartridge was not removed, a Load command causes the tape to be loaded to Beginning of Partition (BOP) again and made ready.</p> <p>If the Load bit is set to 0, and the medium is loaded, the drive writes any buffered data and filemarks to the tape and then rewinds the tape to BOM and unloads the medium back into the cartridge. The green Operate Handle indicator on the tape drive's faceplate illuminates and the cartridge can be removed from the tape drive. If the medium is already unloaded, no action is taken. A "good" status is returned.</p>
EOT	End of Tape. This bit is ignored by the tape drive unless both the EOT and Load bits are set to 1, then the drive returns CHECK CONDITION, ILLEGAL REQUEST data.

Table 5–14 LOAD UNLOAD Command Descriptor Block — Field Descriptions

5.6. LOCATE Command (2Bh)

The LOCATE command is used to do high-speed positioning to the specified block address.

The READ POSITION command can be used to obtain the block address, when writing, when particular blocks of data (a data file, for example) are about to be written. The LOCATE command can then be used to position the tape back at the same logical position for high performance restore operations of particular blocks of data.

Bit	7	6	5	4	3	2	1	0
Byte								
0	Operation Code (2Bh)							
1	Logical Unit Number			Reserved		BT	CP	Immed
2	Reserved							
3 - 6	(MSB) Block Address (LSB)							
7	Reserved							
8	Partition							
9	Unused		Reserved			Flag	Link	

Figure 5-14 LOCATE Command Descriptor Block — Data Format

LOCATE Command (2Bh) (continued)

Field Name	Description
BT	Block Type. The Block Type bit indicates how the Block Address field is interpreted. The first recorded object (block or filemark) is at address 0, and Block Addresses count both data blocks and filemarks.
CP	Change Partition. Since multiple partitions are not supported, this bit must be set to 0.
Immed	Immediate. If this bit is set to 1, status is returned as soon as the operation is started. If set to 0, status is returned after the operation has completed.
Block Address	The Block Address field defines the SCSI Logical Block Address to which the media will be positioned. These addresses start at address 0 and include data blocks and filemarks.
Partition	Not applicable (see <i>Change Partition</i> field above).

Table 5–15 LOCATE Command Descriptor Block — Field Descriptions

5.7. LOG SELECT Command (4Ch)

The LOG SELECT command allows the host to manage statistical information maintained by the tape drive about its own hardware parameters or about the installed tape medium. The description should be read in conjunction with the description of the LOG SENSE command that follows it and provides the user with information about log page format, parameters, and supported pages.

Bit Byte	7	6	5	4	3	2	1	0
0	Operation Code (4Ch)							
1	Logical Unit Number (0)			Reserved			PCR	SP
2	PC		Reserved					
3	Reserved							
4	Reserved							
5	Reserved							
6	Reserved							
7 - 8	(MSB) Parameter List Length (LSB)							
9	Unused		Reserved			Flag		Link

Figure 5–15 LOG SELECT Command Descriptor Block — Data Format

LOG SELECT Command (4Ch) (continued)

Field Name	Description										
PCR	Parameter Code Reset. If this bit is set to 1 and the parameter list length is set to 0, all accumulated values of page codes 2, 3, and 32 are set to 0 and all threshold values are set to default. If PCR is set to 1 and the parameter list length is set to a non-zero value, the command terminates with a CHECK CONDITION status with sense key of ILLEGAL REQUEST and an additional sense code (ASC) of INVALID FIELD IN CDB.										
SP	Save Page. Not supported, must be set to 0. If for some reason the Save Page bit is set, the command terminates with a CHECK CONDITION status with a sense key of ILLEGAL REQUEST and an ASC of INVALID FIELD IN CDB.										
PC	<p>Page Control. This field defines the type of parameter values to be selected:</p> <table border="1"> <thead> <tr> <th>PC</th> <th>Type of Parameter Values</th> </tr> </thead> <tbody> <tr> <td>00b</td> <td>Current Threshold Values</td> </tr> <tr> <td>01b</td> <td>Current Cumulative Values</td> </tr> <tr> <td>10b</td> <td>Default Threshold Values</td> </tr> <tr> <td>11b</td> <td>Default Cumulative Values</td> </tr> </tbody> </table> <p>All of these types of values are changeable using LOG SELECT.</p> <ul style="list-style-type: none"> When the PC field is set to 00b or 01b and the Parameter List Length is set to 0, the command terminates with a CHECK CONDITION status, Sense Key of ILLEGAL REQUEST, and ASC of INVALID FIELD IN CDB. This occurs because modification of Current Threshold Values and Current Cumulative Values is not supported. When the PC field is set to 10b and the Parameter List Length field is set to 10b, then all Current Threshold Values are reset to the Default Threshold Values. This is equivalent to no change, since Threshold Values cannot be modified. When the PC field is set to 11b and the Parameter List Length field is set to 0, then all Current Cumulative Values are reset to the Default Cumulative Values. This is equivalent to clearing all log pages that can be cleared. 	PC	Type of Parameter Values	00b	Current Threshold Values	01b	Current Cumulative Values	10b	Default Threshold Values	11b	Default Cumulative Values
PC	Type of Parameter Values										
00b	Current Threshold Values										
01b	Current Cumulative Values										
10b	Default Threshold Values										
11b	Default Cumulative Values										
Parameter List Length	This field specifies the length, in bytes, of the LOG SELECT parameter list to be transferred from the initiator to the target during the DATA OUT phase. A parameter list length of 0 indicates that no data is to be transferred. This condition is not considered an error.										

Table 5–16 LOG SELECT Command Descriptor Block — Field Descriptions

*LOG SELECT Command (4Ch) (continued)***5.7.1. Log Detection Summary in LOG SELECT Command Descriptor Block**

The following conditions constitute errors that are detected by the drive in relation to the CDB. The request sense data is set to ILLEGAL REQUEST, INVALID FIELD IN CDB.

The conditions that constitute errors are:

- PCR bit is set to 1 and parameter list is not set to 0.
- SP bit is set to 1
- A parameter list length that would cause a parameter within a valid page to be truncated or otherwise incompletely initialized.

5.7.2. Operation of LOG SELECT

The LOG SELECT command allows the initiator to modify and initialize parameters within the logs supported by the tape drive.

There are two ways to initialize the log parameters.

1. Set the PCR bit in the LOG SELECT CDB; this clears all parameters.
2. Specify the log page and parameter values as the log parameters to clear individual pages. The following pages can be cleared using this method:

Page Code	Page Description
02h	Write Error Counter Page
03h	Read Error Counter Page
32h	Compression Ratio Page

If multiple pages are sent during the DATA OUT phase, they must be sent in ascending order according to page code. Otherwise, the command terminates with a CHECK CONDITION status, sense key set to ILLEGAL REQUEST, and additional sense code set to INVALID FIELD IN PARAMETER LIST. The same status is returned if an unsupported Page Code appears in any header or if the specified page cannot be cleared.

*LOG SELECT Command (4Ch) (continued)***5.7.3. Log Select Page Format**

Each log page begins with a 4-byte header followed by *n* number of log parameter blocks (one block for each parameter code). Each block, except for parameter code 05h is comprised of 8 bytes. The parameter block for code 05h is 12 bytes.

LOG PAGE HEADER

Bit	7	6	5	4	3	2	1	0	
Byte									
0	Reserved		Page Code						
1	Reserved								
2 - 3	(MSB)		Page Length						(LSB)

Figure 5–16 Log Page Header Format

Field Name	Description
Page Code	The Page Code specifies for which Log Page this LOG SELECT command is directed.
Page Length	The Page Length field specifies the total number of bytes contained in this log page, not including the four bytes that make up the header.

Table 5–17 Log Page Header Field Descriptions

*LOG SELECT Command (4Ch) (continued)***LOG PARAMETERS**

Bit Byte	7	6	5	4	3	2	1	0
0 - 1	(MSB) Parameter Code							(LSB)
2	DU	DS	TSD	ETC	TMC	Rsv'd	LP	
3	Parameter Length							
4 - 7	(MSB) Parameter Value							(LSB)

Figure 5–17 Log Parameters Format

Field Name	Description
Parameter Code	Parameter Codes supported for the READ/WRITE error counter pages are as follows: Parameter Code Descriptions <hr/> 00h Errors corrected with substantial delays 01h Errors corrected with possible delays 02h Total rewrites or rereads 03h Total errors corrected 04h Total times correction algorithm processed 05h Total bytes processed 06h Total uncorrected errors 8000h Vendor Unique Note: Parameter codes 00h, 01h, and 04h always have a value of 0. Parameter value for 05h is 8 bytes; the parameter length is set to 8.

Table 5–18 Log Parameters Field Descriptions

LOG SELECT Command (4Ch) (continued)

Field Name	Description
<p>NOTE</p> <p>Byte 2 of the Log Parameter Block is referred to as the Parameter Control Byte; it is made up of six control bits plus one bit that is reserved.</p>	
DU	Disable Update. This bit is not defined for LOG SELECT; the target ignores any value in DU.
DS	Disable Save. Not supported. DS and Target Save Disable (TSD) must be set to 1. If DS and/or TSD are set to 0, command terminates with CHECK CONDITION status, sense key set to ILLEGAL REQUEST, and additional sense code set to INVALID FIELD IN PARAMETER LIST.
TSD	Target Save Disable. Not supported. TDS and DS must be set to 1. If TSD and/or DS are set to 0, command terminates with CHECK CONDITION status, sense key set to ILLEGAL REQUEST, and additional sense code set to INVALID FIELD IN PARAMETER LIST.
ETC	Enable Threshold Comparison. When set to 1, drive performs a comparison with threshold values once the cumulative value is updated. Comparison criteria is defined in Threshold Met Criteria (TMC). If the comparison is met and the RLEC bit of MODE SELECT / SENSE Control Page 0Ah is set to 1, then a UNIT ATTENTION is generated for all initiators. The additional sense code is set to THRESHOLD CONDITION MET. If the RLEC bit is 0 and the comparison is met, then UNIT ATTENTION is not generated.

*(continued)**Table 5–18 Log Parameters Field Descriptions (continued)*

LOG SELECT Command (4Ch) (continued)

Field Name	Description										
TMC	<p>Threshold Met Criteria. Once the criteria specified in this field is met and the ETC bit is 1 and the RLEC bit in MODE SENSE / SELECT Control Page is set to 1, then UNIT ATTENTION is generated for all initiators.</p> <p>The criteria for comparison are:</p> <table border="1"> <thead> <tr> <th>Code</th> <th>Basis of Comparison</th> </tr> </thead> <tbody> <tr> <td>00b</td> <td>Every update of the cumulative value</td> </tr> <tr> <td>01b</td> <td>Cumulative value equal to threshold value</td> </tr> <tr> <td>10b</td> <td>Cumulative value not equal to threshold value</td> </tr> <tr> <td>11b</td> <td>Cumulative value greater than threshold value</td> </tr> </tbody> </table> <ul style="list-style-type: none"> • The Default Threshold Values are the maximum values that each parameter can attain. • The Current Cumulative Values are the values computed since the last reset of the device (either via power-cycle, BUS DEVICE RESET, or SCSI RESET). • The Default Cumulative Values are the values to which each parameter is initialized at a reset condition. Default values are zero. • By default, Current Threshold Values = Default Threshold Values. <p>Note that all types of parameter values are changeable via LOG SELECT.</p>	Code	Basis of Comparison	00b	Every update of the cumulative value	01b	Cumulative value equal to threshold value	10b	Cumulative value not equal to threshold value	11b	Cumulative value greater than threshold value
Code	Basis of Comparison										
00b	Every update of the cumulative value										
01b	Cumulative value equal to threshold value										
10b	Cumulative value not equal to threshold value										
11b	Cumulative value greater than threshold value										
LP	List Parameter. This bit should always be set to 0 to indicate parameter codes are treated as data counters.										
Parameter Length	This field specifies the number of bytes of the parameter value.										
Parameter Value	This field indicates the actual value of this log parameter.										

Table 5–18 Log Parameters Field Descriptions (continued)

5.7.4. Error Detection Summary in Log Select Pages

The host issues a LOG SENSE command to initialize host-resident software that allows determination of:

- The log pages used by the drive
- The parameter codes and length of each parameter

The following conditions constitute errors in the parameter block that cause the drive to return CHECK CONDITION with sense data set to ILLEGAL REQUEST and additional send code INVALID FIELD IN PARAMETER LIST:

- A page header is received with unsupported page codes
- An incorrect log page length is specified in the page header
- An illegal parameter code is contained in a valid page code
- Parameter codes for a supported page are not sent in ascending order
- The LP bit (Table 5-18) is set to 1 in the parameter control byte
- The DS bit (Table 5-18) is set to 0 in the parameter control byte
- The TSD bit (Table 5-18) is set to 0 in the parameter control byte

5.8. LOG SENSE Command (4Dh)

The LOG SENSE command allows the host to retrieve statistical information maintained by the tape drive about its own hardware parameters or about the installed tape medium. It is a complementary command to LOG SELECT.

Bit Byte	7	6	5	4	3	2	1	0
0	Operation Code (4Dh)							
1	Logical Unit Number (0)			Reserved			PPC	SP(0)
2	PC		Page Code					
3	Reserved							
4	Reserved							
5 - 6	(MSB) Parameter Pointer (LSB)							
7 - 8	(MSB) Allocation Length (LSB)							
9	Unused		Reserved			Flag	Link	

Figure 5–18 LOG SENSE Command Descriptor Block — Data Format

LOG SENSE Command (4Dh) (continued)

Field Name	Description										
PPC	<p>Parameter Pointer Control. This bit must be set to 0. A PPC of 0 indicates that the parameter data requested from the device starts with the parameter code specified in the Parameter Pointer field (Bytes 5 - 6) and return the number of bytes specified in the Allocation Length field (Bytes 7 - 8) in ascending order of parameter codes from the specified log page.</p> <p>Note that the current implementation of the READ/WRITE COMPRESSION page does not support a PPC other than 0. If PPCbit is set, then the target terminates the command with CHECK CONDITION status, sense key set to ILLEGAL REQUEST, and additional sense code set to INVALID FIELD IN CDB.</p>										
SP	<p>Save Parameters. Not supported, must be set to 0. If for some reason the Save Parameters bit is set, the command terminates with a CHECK CONDITION status with a sense key of ILLEGAL REQUEST and an ASC of INVALID FIELD IN CDB.</p>										
PC	<p>Page Control. This field defines the type of parameter values to be returned:</p> <table border="1"> <thead> <tr> <th>PC</th> <th>Type of Parameter Values</th> </tr> </thead> <tbody> <tr> <td>00b</td> <td>Threshold Values</td> </tr> <tr> <td>01b</td> <td>Cumulative Values</td> </tr> <tr> <td>10b</td> <td>Default Threshold Values</td> </tr> <tr> <td>11b</td> <td>Default Cumulative Values</td> </tr> </tbody> </table> <ul style="list-style-type: none"> • The Default Threshold Values are the maximum values that each parameter can attain. • The Current Cumulative Values are the values computed since the last reset of the device (either via power-cycle, BUS DEVICE RESET, or SCSI RESET). • The Default Cumulative Values are the values to which each parameter is initialized at a reset condition. Default values are zero. • By default, Current Threshold Values = Default Threshold Values. <p>Note that all types of parameter values are changeable via LOG SELECT.</p>	PC	Type of Parameter Values	00b	Threshold Values	01b	Cumulative Values	10b	Default Threshold Values	11b	Default Cumulative Values
PC	Type of Parameter Values										
00b	Threshold Values										
01b	Cumulative Values										
10b	Default Threshold Values										
11b	Default Cumulative Values										

Table 5–19 LOG SENSE Command Descriptor Block — Field Descriptions

LOG SENSE Command (4Dh) (continued)

Field Name	Description																											
Page Code	<p>The Page Code field identifies which log page is being requested by the initiator. If the page is not supported, then the command terminates with a CHECK CONDITION status, sense key set to ILLEGAL REQUEST, and additional sense code of INVALID FIELD IN CDB. Supported pages are:</p> <table border="1"> <thead> <tr> <th>Page Code</th> <th>Page Definition</th> <th>See Section</th> </tr> </thead> <tbody> <tr> <td>00h</td> <td>List of Supported Pages Page</td> <td>5.8.2</td> </tr> <tr> <td>02h</td> <td>Write Error Counter Page</td> <td>5.8.3</td> </tr> <tr> <td>03h</td> <td>Read Error Counter Page</td> <td>5.8.3</td> </tr> <tr> <td>07h</td> <td>Last n Errors Events Page</td> <td>5.8.4</td> </tr> <tr> <td>2Eh</td> <td>TapeAlert Page</td> <td>5.8.5</td> </tr> <tr> <td>32h</td> <td>Compression Ratio Page</td> <td>5.8.6</td> </tr> <tr> <td>33h</td> <td>Device Wellness Log Page</td> <td>5.8.7</td> </tr> <tr> <td>3Eh</td> <td>Device Status Log Page</td> <td>5.8.8</td> </tr> </tbody> </table>	Page Code	Page Definition	See Section	00h	List of Supported Pages Page	5.8.2	02h	Write Error Counter Page	5.8.3	03h	Read Error Counter Page	5.8.3	07h	Last n Errors Events Page	5.8.4	2Eh	TapeAlert Page	5.8.5	32h	Compression Ratio Page	5.8.6	33h	Device Wellness Log Page	5.8.7	3Eh	Device Status Log Page	5.8.8
Page Code	Page Definition	See Section																										
00h	List of Supported Pages Page	5.8.2																										
02h	Write Error Counter Page	5.8.3																										
03h	Read Error Counter Page	5.8.3																										
07h	Last n Errors Events Page	5.8.4																										
2Eh	TapeAlert Page	5.8.5																										
32h	Compression Ratio Page	5.8.6																										
33h	Device Wellness Log Page	5.8.7																										
3Eh	Device Status Log Page	5.8.8																										
Parameter Pointer	<p>The Parameter Pointer field allows the host to specify at which parameter within a log page the requested data should begin. For example, if a page supports parameters 0 through 5, and the Parameter Pointer contains 3, then only parameters 3, 4, and 5 are returned to the initiator. Similarly, if a page supports parameters 1, 3, and 6, and the Parameter Pointer contains 2, then only parameters 3 and 6 are returned to the initiator.</p> <p>If the Parameter Pointer is larger than the highest numbered parameter on the page, then the target terminates the command with CHECK CONDITION status, sense key set to ILLEGAL REQUEST, and additional sense code set to INVALID FIELD IN CDB.</p> <p>Note that parameters within a page are always returned in ascending order according to parameter code.</p> <p>If the target does not support a parameter code within this page then it does not return any data associated with this parameter.</p>																											
Allocation Length	<p>This field specifies the maximum number of bytes that the initiator has allocated for returning data. The host uses this field to limit the size of data transfers to its own internal buffer size.</p>																											

Table 5–19 LOG SENSE Command Descriptor Block — Field Descriptions (continued)

LOG SENSE Command (4Dh) (continued)

5.8.1. Error Detection Summary in LOG SENSE Command Descriptor Block

The following conditions constitute errors detected by the drive relating to the LOG SENSE command descriptor block. The request sense data is set to ILLEGAL REQUEST, INVALID FIELD IN CDB.

Error conditions occur when:

- A page is not supported
- The parameter pointer is larger than the highest numbered parameter on the page
- The SP bit is set to 1
- The Allocation Length is smaller than the data being returned by the target.
- PPC bit set to 1

*LOG SENSE Command (4Dh) (continued)***5.8.2. Supported Pages Log Page (Page 00h)**

When page 00h is requested, the 4-byte page header is returned, followed by the pages supported in ascending order, one byte for each.

Bit Byte	7	6	5	4	3	2	1	0
0	Reserved		Page Code (00h)					
1	Reserved							
2 - 3	(MSB) Page Length (05h) (LSB)							
4	00h							
5	02h							
6	03h							
7	07h							
8	2Eh							
9	32h							
10	33h							
11	3Eh							

Figure 5–19 Supported Pages Page — Data Format

*LOG SENSE Command (4Dh) (continued)***5.8.3. READ (Page 03h) / WRITE (Page 02h) ERROR LOG SENSE Page**

Each Log page begins with a 4-byte header followed by a number of log parameter blocks. Each block consists of 8 bytes except for parameter code 05h.

The log parameter block for the parameter total bytes processed (05h) is 12 bytes, since the parameter value is 8 bytes long.

LOG PAGE HEADER

Bit	7	6	5	4	3	2	1	0	
Byte									
0	Reserved		Page Code						
1	Reserved								
2 - 3	(MSB)			Page Length					(LSB)

Figure 5–20 READ / WRITE Error LOG SENSE Header Format

Field Name	Description
Page Code	The Page Code echoes the page code that was specified in the LOG SENSE command descriptor block.
Page Length	The Page Length field specifies the total number of bytes contained in this log page, not including the four bytes that make up the header. For example, if the PPC bit is 0 and the parameter pointer is 0, the target returns 4 bytes of page header with page length of 44h followed by 8 bytes of parameter value data for each parameter code except code 05h (for code 05h, it returns 12 bytes). Therefore, for parameters codes 00h, 01h, 02h, 03h, 04h, 06h, and 8000h, each page will be 8 bytes.

Table 5–20 READ / WRITE Error LOG SENSE Header Field Descriptions

*LOG SENSE Command (4Dh) (continued)***LOG PARAMETERS**

Bit	7	6	5	4	3	2	1	0
Byte								
0 - 1	(MSB) Parameter Code							(LSB)
2	DU	DS	TSD	ETC	TMC		Rsv'd	LP
3	Parameter Length							
4 - 11	(MSB) Parameter Value							(LSB)

Figure 5–21 Log Parameters Format for READ / WRITE Error LOG SENSE Page

Field Name	Description																				
Parameter Code	Parameter Codes supported for the READ/WRITE error counter pages are as follows:																				
	<table border="1"> <thead> <tr> <th>Parameter Code</th> <th>Descriptions</th> </tr> </thead> <tbody> <tr> <td>00h</td> <td>Errors corrected with substantial delays</td> </tr> <tr> <td>01h</td> <td>Errors corrected with possible delays</td> </tr> <tr> <td>02h</td> <td>Total rewrites or rereads</td> </tr> <tr> <td>03h</td> <td>Total errors corrected</td> </tr> <tr> <td>04h</td> <td>Total times correction algorithm processed</td> </tr> <tr> <td>05h</td> <td>Total bytes processed</td> </tr> <tr> <td>06h</td> <td>Total uncorrected errors</td> </tr> <tr> <td>8001h</td> <td>Vendor Unique</td> </tr> <tr> <td>9001h</td> <td>Vendor Unique</td> </tr> </tbody> </table>	Parameter Code	Descriptions	00h	Errors corrected with substantial delays	01h	Errors corrected with possible delays	02h	Total rewrites or rereads	03h	Total errors corrected	04h	Total times correction algorithm processed	05h	Total bytes processed	06h	Total uncorrected errors	8001h	Vendor Unique	9001h	Vendor Unique
Parameter Code	Descriptions																				
00h	Errors corrected with substantial delays																				
01h	Errors corrected with possible delays																				
02h	Total rewrites or rereads																				
03h	Total errors corrected																				
04h	Total times correction algorithm processed																				
05h	Total bytes processed																				
06h	Total uncorrected errors																				
8001h	Vendor Unique																				
9001h	Vendor Unique																				
	<p>Note: Parameter codes 00h, 01h, and 04h always return a value of 0. Parameter value for 05h is 8 bytes; the parameter length is set to 8.</p>																				

Table 5–21 Log Parameters for READ / WRITE Error LOG SENSE Page Field Descriptions

LOG SENSE Command (4Dh) (continued)

Field Name	Description										
NOTE: Byte 2 of the Log Parameter Block is referred to as the Parameter Control Byte; it is made up of six control bits plus one bit that is reserved.											
DU	<p>Disable Update. This field with a value 0 indicates that the target will update all log parameter values. This field set to 1 indicates that the target will not update the log parameter values except in response to LOG SELECT. This bit is set by the drive when accumulated values reach maximum. This is also returned set to 1 if the host set the bit in the last LOG SELECT command. Default is 0.</p> <p>Note that for parameter types other than threshold and cumulative values, this bit is always 0.</p>										
DS	Disable Save. Not supported; always set to 1.										
TSD	Target Save Disable. Not supported; always set to 1.										
ETC	Enable Threshold Comparison. When set to 1, indicates that comparison to threshold is performed. ETC of 0 indicates that the comparison is not performed. This bit is set to 1 by the Control Mode Page of MODE SELECT. Default is 0.										
TMC	<p>Threshold Met Criteria. This field is valid only if host sets ETC to 1. It determines the basis for comparison and is specified by host using LOG SELECT. If the result of comparison is true (cumulative = threshold), and MODE SELECT / SENSE Control Mode Page RLEC bit is set to 1, then a UNIT ATTENTION is granted for all initiators. The sense key is set to UNIT ATTENTION, the additional sense code to LOG EXCEPTION, and ASCQ is set to THRESHOLD CONDITION MET. If the RLEC bit in Control Mode Page is 0, then UNIT ATTENTION is not generated.</p> <p>Note that comparison is performed in real time. A Log Sense command need not be issued to get the check condition. Once ETC is selected, RLEC bit in Control Mode Page, the check condition is issued based on the criteria defined in the TMC bits if the criteria is met in real time. Check condition will not identify for which parameter code the criteria is met. Log Sense must be issued to read the counters to determine for which parameter code criteria has been met.</p> <p>The criteria for comparison are:</p> <table border="1"> <thead> <tr> <th>Code</th> <th>Basis of Comparison</th> </tr> </thead> <tbody> <tr> <td>00b</td> <td>Every update of the cumulative value</td> </tr> <tr> <td>01b</td> <td>Cumulative value equal to threshold value</td> </tr> <tr> <td>10b</td> <td>Cumulative value not equal to threshold value</td> </tr> <tr> <td>11b</td> <td>Cumulative value greater than threshold value</td> </tr> </tbody> </table>	Code	Basis of Comparison	00b	Every update of the cumulative value	01b	Cumulative value equal to threshold value	10b	Cumulative value not equal to threshold value	11b	Cumulative value greater than threshold value
Code	Basis of Comparison										
00b	Every update of the cumulative value										
01b	Cumulative value equal to threshold value										
10b	Cumulative value not equal to threshold value										
11b	Cumulative value greater than threshold value										

Table 5–21 Log Parameters for READ / WRITE Error LOG SENSE Page Field Descriptions (continued)

LOG SENSE Command (4Dh) (continued)

Field Name	Description
LP	List Parameter. This bit is 0 since the parameter codes are treated as data counters.
Parameter Length	This field specifies the number of bytes of the parameter value.
Parameter Value	This field indicates the actual value of this log parameter.

Table 5–21 Log Parameters for READ / WRITE Error LOG SENSE Page Field Descriptions (continued)

*LOG SENSE Command (4Dh) (continued)***5.8.4. LAST *n* ERROR EVENTS Page (07h)**

This page returns one parameter at a time that contains the ASCII text for the specified event log. The Parameter Number field in the CDB specifies the log event to return. The log events in EEPROM are numbered from 0 to 255, after which the number wraps back to 0; only a limited number of events are stored at a given time (up to 48). The log event that is returned is the one whose Parameter Code is equal to, or the first one greater than, the Parameter Number specified in the command control block.

LOG PAGE HEADER

Bit	7	6	5	4	3	2	1	0	
Byte									
0	Reserved		Page Code (07h)						
1	Reserved								
2 - 3	(MSB)		Page Length						(LSB)

*Figure 5–22 Last *n* Error Events LOG SENSE Header Format*

Field Name	Description
Page Code	The Page Code echoes the page code that was specified in the LOG SENSE command descriptor block.
Page Length	The Page Length field specifies the total number of bytes contained in this log page, not including the four bytes that make up the header.

*Table 5–22 Last *n* Error Events LOG SENSE Header Field Descriptions*

*LOG SENSE Command (4Dh) (continued)***LOG PARAMETERS**

Bit	7	6	5	4	3	2	1	0
Byte								
0 - 1	(MSB) Parameter Code							(LSB)
2	DU	DS	TSD	ETC	TMC	Rsv'd	LP	
3	Parameter Length							
4 - n	(MSB) Hex ASCII String for Event n							(LSB)

Figure 5–23 Log Parameters Format for LAST n ERROR EVENTS LOG SENSE Page

Field Name	Description
Parameter Code	Parameter Code values are assigned from 0 to 27, where 0 is the oldest event stored and the highest Parameter Code returned is the most recent event.
Hex ASCII String fo Event n	The text of the parameter includes a “Packet #” that is a value from 0 to 255. This internal number is assigned when the packet is written to EEPROM. A value of 0 is normally the oldest packet, but packet numbers can wrap around back to 0 after reaching 255. For a description of the packet string, see Appendix B.

*Table 5–23 Log Parameters for LAST n ERROR EVENTS LOG SENSE
Page Field Descriptions*

For definitions of bits that make up the Control Byte (byte 2), refer to Section 5.8.3., Table 5-21.

*LOG SENSE Command (4Dh) (continued)***5.8.5. TapeAlert Page (2Eh)**

This page returns results of the tape drive's on-going self diagnosis, so that the tape drive's behavior can be monitored and high reliability ensured. The TapeAlert page is read from the tape drive at the beginning of each READ/WRITE activity, after any fatal errors occur during a READ/WRITE, at the end of any tape cartridge when the READ/WRITE activity continues onto another tape cartridge, and at the end of each READ/WRITE activity. The flags (Table 5–26) are set or cleared by the tape drive when the failure or corrective action occurs.

TAPE ALERT LOG PAGE HEADER

Bit	7	6	5	4	3	2	1	0
Byte								
0	Page Code (2Eh)							
1	Reserved							
2 - 3	(MSB)	Page Length						(LSB)

Figure 5–24 TapeAlert LOG SENSE Header Format

Field Name	Description
Page Code	The Page Code echoes the page code that was specified in the LOG SENSE command descriptor block.
Page Length	The Page Length field specifies the total number of bytes contained in this log page, not including the four bytes that make up the header.

Table 5–24 TapeAlert LOG SENSE Header Field Descriptions

*LOG SENSE Command (4Dh) (continued)***TAPE ALERT LOG PARAMETERS**

Bit	7	6	5	4	3	2	1	0
Byte								
$5n - 1$ to $5n$	(MSB) Parameter Code (n)							(LSB)
$5n + 1$	DU	DS	TSD	ETC	TMC	Rsv'd	LP	
$5n + 2$	Parameter Length (1)							
$5n + 3$	Value of TapeAlert Flag (Flag is set when Bit 0 = 1; Bits 1 – 7 are Reserved)							

Figure 5–25 Log Parameters Format for TapeAlert Page

Field Name	Description
Parameter Code	This field contains the Flag code. See Table 5-26 for the supported Flags, level of severity, and the Flags' definitions.
Parameter Length	This field is set to 1.
Value of Tape Alert Flag	If Bit 0 is set to 1, indicates that TapeAlert has sensed a problem. See Table 5-26 for the supported Flags and their definitions. If Bit 0 is 0, the Flag is not set and no problem has been sensed.

Table 5–25 Log Parameter Field Descriptions for TapeAlert Page

For definitions of bits that make up the Control Byte (the byte “ $5n + 1$ ” above), refer to Section 5.8.3, Table 5-21.

LOG SENSE Command (4Dh) (continued)

Flag	Severity Level *	Meaning
1 Read Warning	Warning	Problems reading data. There is no loss of data, but the tape drive's performance is reduced.
2 Write Warning	Warning	Problems writing data. There is no loss of data, but the capacity of the tape is reduced.
3 Hard Error	Warning	An error has occurred during a read or write operation that the tape drive cannot correct: operation has stopped.
5 Read Failure	Critical	The tape medium or the tape drive is damaged. Contact a service representative.
6 Write Failure	Critical	The tape medium is faulty or the tape drive is damaged. Test the tape drive using a known-good tape cartridge. If the problem persists, contact a service representative.
9 Write Protect	Critical	The tape cartridge is write protected. Set the write protection switch to enable writing, or use a different tape cartridge.
10 No Removal	Informational	The tape drive is busy and the tape cartridge cannot be ejected. Wait for the operation to complete before attempting to eject the tape cartridge.
11 Cleaning Media	Informational	The tape cartridge in the tape drive is a cleaning cartridge. For normal tape drive data-related operations, replace the cleaning cartridge with a data tape cartridge.
20 Clean Now	Critical	The tape drive needs to be cleaned. Make sure that all tape operations have completed, eject the data tape cartridge and follow the appropriate steps to use a cleaning cartridge.

* Severity levels are *Informational*, *Warning*, and *Critical*. Informational flags provide a status-type message, Warning and Critical flags indicate that user intervention and/or service call may be required.

Table 5–26 Tape Alert Flags, Severity Levels, and Meanings

LOG SENSE Command (4Dh) (continued)

Flag	Severity Level *	Meaning
22 Expired Cleaning Media	Critical	The cleaning cartridge that was used has expired. Wait for all tape drive operations to complete, then use a valid cleaning cartridge for cleaning.
31 Hardware B	Critical	The tape drive may have a hardware fault. Contact a service representative.
32 Interface	Warning	The drive has identified a problem with the interface to/from the host.
34 Download Fail	Warning	The attempted firmware download has failed.
36 Drive Temperature	Warning	Temperature within the tape drive is exceeding the allowable specifications
40 Loader Hardware A	Critical	The mechanism that loads media to the tape drive is experiencing problems communicating with the tape drive.
42 Loader Hardware B	Warning	The loader mechanism has experienced a hardware-related fault.
43 Loader Door	Critical	The attempted operation has failed: the library/autoloader door is not closed completely.

* Severity levels are *Informational*, *Warning*, and *Critical*. Informational flags provide a status-type message, Warning and Critical flags indicate that user intervention and/or service call may be required.

Table 5–26 Tape Alert Flags, Severity Levels, and Meanings (continued)

*LOG SENSE Command (4Dh) (continued)***5.8.6. READ / WRITE COMPRESSION Page (32h)**

This page begins with a 4-byte header followed by the log parameter blocks of 6 or 8 bytes, depending on the Parameter Code selected.

LOG PAGE HEADER

Bit	7	6	5	4	3	2	1	0
Byte								
0	Reserved		Page Code (32h)					
1	Reserved							
2 - 3	(MSB) Additional Length (LSB)							

Figure 5–26 READ / WRITE COMPRESSION RATIO LOG SENSE Header Format

Field Name	Description
Page Code	The Page Code echoes the page code that was specified in the LOG SENSE command descriptor block.
Additional Length	The Additional Length field specifies the number of bytes available and depends on the parameters requested.

Table 5–27 READ / WRITE COMPRESSION RATIO LOG SENSE Header Field Descriptions

*LOG SENSE Command (4Dh) (continued)***LOG PARAMETERS FOR PARAMETER CODES 00h AND 01h**

Bit Byte	7	6	5	4	3	2	1	0
0 - 1	(MSB) Parameter Code							(LSB)
2	DU	DS	TSD	ETC	TMC		Rsv'd	LP
3	02h							
4 - n	(MSB) Compression Ratio x 100							(LSB)

Figure 5–27 Log Parameters Format for READ / WRITE COMPRESSION RATIO LOG SENSE Page (Parameter Codes 00h and 01h)

Field Name	Description
Parameter Code	Parameter Codes supported for the READ / WRITE COMPRESSION RATIO page are as follows (for codes 00h and 01h only; codes 02h through 09h are detailed separately): Parameter Code Descriptions <hr/> 00h READ Compression Ratio x 100 01h WRITE Compression Ratio x 100 <hr/>
DU	Disable Update. Always 0.
DS	Disable Save. Not supported. This bit always set to 1.
TSD	Target Save Disable. Not supported. This bit always set to 1.
ETC	Enable Threshold Comparison. Threshold checking is not supported on this page. Always set to 0.
TMC	Threshold Met Criteria. Always 0.
LP	List Parameter. Always set to 0 (parameter codes treated as data counter).

Table 5–28 Log Parameters for READ / WRITE COMPRESSION RATIO LOG SENSE Page Field Descriptions (Parameter Codes 00h and 01h)

LOG SENSE Command (4Dh) (continued)

LOG PARAMETERS FOR PARAMETER CODES 02h THROUGH 09h

Bit	7	6	5	4	3	2	1	0
Byte								
0 - 1	(MSB) Parameter Code							(LSB)
2	DU	DS	TSD	ETC	TMC	Rsv'd	LP	
3	04h							
4 - 7	(MSB) Counter Value							(LSB)

Figure 5–28 Log Parameters Format for READ / WRITE COMPRESSION RATIO LOG SENSE Page (Parameter Codes 02h through 09h)

Field Name	Description
Parameter Code	Parameter Codes supported for the READ / WRITE COMPRESSION RATIO page (codes 02h through 09h) are as follows:
	Parameter Code Descriptions
	02h Mbytes Transferred to Host
	03h Bytes Transferred to Host
	04h Mbytes Read from Tape
	05h Bytes Read from Tape
	06h Mbytes Transferred from Host
	07h Bytes Transferred from Host
	08h Mbytes Written to Tape
	09h Bytes Written to Tape

Table 5–29 Log Parameters for READ / WRITE COMPRESSION RATIO LOG SENSE Page Field Descriptions (Parameter Codes 02h through 09h)

LOG SENSE Command (4Dh) (continued)

Field Name	Description
DU	Disable Update. Always 0.
DS	Disable Save. Not supported. This bit always set to 1.
TSD	Target Save Disable. Not supported. This bit always set to 1.
ETC	Enable Threshold Comparison. Threshold checking is not supported on this page. Always set to 0.
TMC	Threshold Met Criteria. Always 0.
LP	List Parameter. Always set to 0 (parameter codes treated as data counter).
Counter Value	Parameter Codes 02h through 09h provide a count of the number of bytes transferred since the current tape cartridge was inserted or since the last time the counters were reset via a MODE SELECT command.
	<u>Parameter Codes 02h and 03h</u> -- Report the count of bytes transferred from the tape drive to the initiator. Parameter Code 02h reports the number of full megabytes transferred; Parameter Code 03h reports the number of bytes less than a full megabyte that have been transferred. Multiplying the counter returned for Parameter Code 02h by 1,048,576 and then adding the value of the counter returned by Parameter Code 03h results in the actual total bytes transferred to the initiator.
	<u>Parameter Codes 04h and 05h</u> -- Report the count of bytes transferred from the tape drive to the buffer. Parameter Code 04h reports the number of full megabytes transferred; Parameter Code 05h reports the number of bytes less than a full megabyte that have been transferred. Multiplying the counter returned for Parameter Code 04h by 1,048,576 and then adding the value of the counter returned by Parameter Code 05h results in the actual total bytes transferred from tape to the buffer.
	<u>Parameter Codes 06h and 07h</u> -- Report the count of bytes transferred from the initiator to the buffer. Parameter Code 06h reports the number of full megabytes transferred; Parameter Code 07h reports the number of bytes less than a full megabyte that have been transferred. Multiplying the counter returned for Parameter Code 06h by 1,048,576 and then adding the value of the counter returned by Parameter Code 07h results in the actual total bytes transferred from the initiator to the buffer.
	<u>Parameter Codes 08h and 09h</u> -- Report the count of bytes written to the tape drive. Parameter Code 08h reports the number of full megabytes transferred; Parameter Code 09h reports the number of bytes less than a full megabyte that have been transferred. Multiplying the counter returned for Parameter Code 08h by 1,048,576 and then adding the value of the counter returned by Parameter Code 09h results in the actual total bytes written to the tape drive.

*Table 5–29 Log Parameters for READ / WRITE COMPRESSION RATIO LOG SENSE
Page Field Descriptions (Parameter Codes 02h through 09h) (continued)*

*LOG SENSE Command (4Dh) (continued)***5.8.7. Device Wellness Page (33h)**

The Device Wellness Page returns information about any check conditions related to Sense Keys 1, 3, 4, and 9 logged by the tape drive. Up to 16 entries (parameter code 0000h to 000Fh) can be contained in the page; each entry records a check condition (Sense Key = 1), a medium error (Sense Key = 3), or hardware error (Sense Key = 4). Note that parameter code 000h contains the oldest log information while parameter 000Fh contains the most recent.

Only head cleaning recovered errors (more serious recovered errors) are recorded when Sense Key is 1; all sense data are recorded when Sense Key is 3 or 4.

This page begins with a 4-byte header followed by the log parameter blocks.

LOG PAGE HEADER

Bit	7	6	5	4	3	2	1	0
Byte								
1	Reserved		Page Code (33h)					
1	Reserved							
2 - 3	(MSB) Page Length (LSB)							

Figure 5–29 DEVICE WELLNESS LOG SENSE Header Format

Field Name	Description
Page Code	The Page Code echoes the page code that was specified in the LOG SENSE command descriptor block.
Page Length	The Page Length field specifies the number of bytes available and depends on the parameters requested.

Table 5–30 DEVICE WELLNESS LOG SENSE Header Field Descriptions

*LOG SENSE Command (4Dh) (continued)***DEVICE WELLNESS LOG SENSE PAGE PARAMETERS (0000h - 000Fh)**

Bit Byte	7	6	5	4	3	2	1	0
0	Parameter Code							
1	Reserved							
2	DU	DS	TSD	ETC	TMC		Rsv'd	LP
3 - 7	(MSB) Time Stamp							(LSB)
8 - 11	(MSB) Media ID							(LSB)
12	Sense Key							
13	Additional Sense Key							
15	Additional Error Information							

Figure 5–30 Log Parameters Format for DEVICE WELLNESS LOG SENSE Page

LOG SENSE Command (4Dh) (continued)

Field Name	Description
Parameter Code	Parameter Codes 0000h through 000Fh are supported. This provides 16 log entries for error information capture.
DU	Disable Update. Always 0.
DS	Disable Save. Not supported. This bit always set to 1.
TSD	Target Save Disable. Not supported. This bit always set to 0.
ETC	Enable Threshold Comparison. Threshold checking is not supported on this page. Always set to 0.
TMC	Threshold Met Criteria. Always 0.
LP	List Parameter. Always set to 0.
Time Stamp	Power-on hours when check condition occurred (note that this is the number of power-on hours since the last time the unit was powered on, not total number of hours during the lifetime of the drive). The time stamp counter is updated once per hour; if the tape drive is powered down before the hourly update occurs, the update will not occur until a full hour after power is re-applied.
Media ID	Internal media identifier being used when check condition occurred. 0 = no media or unknown media when event occurred. Note that this is not an applicable means of tracing media.

Table 5–31 Log Parameters for DEVICE WELLNESS LOG SENSE Page Field Descriptions

*LOG SENSE Command (4Dh) (continued)***5.8.8. Device Status Page (3Eh)**

The Device Status Page describes the current status of the tape drive. Figures 5-31 and 5-32 and Table 5-32 describe the following header log parameter formats for the log sense device status page.

<u>Code</u>	<u>Provides</u>
0000h	Device type.
0001h	Device cleaning-related status
0002h	Number of “loads” over the lifetime of the tape drive.
0003h	Specifies the number of cleaning sessions per cartridge.
0004h	Vendor-unique
0005h	Drive temperature in degrees C

LOG PAGE HEADER

Bit	7	6	5	4	3	2	1	0
Byte								
1	Reserved		Page Code (3Eh)					
1	Reserved							
2 - 3	(MSB) Page Length						(LSB)	

Figure 5–31 DEVICE STATUS LOG SENSE Header Format

Field Name	Description
Page Code	The Page Code echoes the page code that was specified in the LOG SENSE command descriptor block.
Page Length	The Page Length field specifies the number of bytes available and depends on the parameters requested.

Table 5–32 DEVICE STATUS LOG SENSE Header Field Descriptions

*LOG SENSE Command (4Dh) (continued)***DEVICE STATUS LOG SENSE PAGE PARAMETERS**

Bit	7	6	5	4	3	2	1	0
Byte								
0 - 1	Parameter Code							
2	DU	DS	TSD	ETC	TMC	Rsv'd	LP	
3	Parameter Length (04h)							
4 - 7	Parameter Value (MSB) (LSB)							

Figure 5–32 Log Parameters Format for DEVICE STATUS LOG SENSE Page

LOG SENSE Command (4Dh) (continued)

Field Name	Description														
Parameter Value	Parameter Codes 0000h through 0005h are supported.														
	<table border="1"> <thead> <tr> <th>Code</th> <th>Description</th> </tr> </thead> <tbody> <tr> <td>0000h</td> <td>Specifies device type. For sequential-type devices such as tape drives, the value is always 00010000h.</td> </tr> <tr> <td>0001h</td> <td>Specifies device cleaning-related status. See Figure 5-30.</td> </tr> <tr> <td>0002h</td> <td>Specifies the number of “loads” over the lifetime of the tape drive.</td> </tr> <tr> <td>0003h</td> <td>Specifies the number of cleaning sessions per cartridge.</td> </tr> <tr> <td>0004h</td> <td>Vendor-unique</td> </tr> <tr> <td>0005h</td> <td>Drive Temperature in degreesC</td> </tr> </tbody> </table>	Code	Description	0000h	Specifies device type. For sequential-type devices such as tape drives, the value is always 00010000h.	0001h	Specifies device cleaning-related status. See Figure 5-30.	0002h	Specifies the number of “loads” over the lifetime of the tape drive.	0003h	Specifies the number of cleaning sessions per cartridge.	0004h	Vendor-unique	0005h	Drive Temperature in degreesC
Code	Description														
0000h	Specifies device type. For sequential-type devices such as tape drives, the value is always 00010000h.														
0001h	Specifies device cleaning-related status. See Figure 5-30.														
0002h	Specifies the number of “loads” over the lifetime of the tape drive.														
0003h	Specifies the number of cleaning sessions per cartridge.														
0004h	Vendor-unique														
0005h	Drive Temperature in degreesC														
DU	Disable Update. Always 0.														
DS	Disable Save. Not supported. This bit always set to 1.														
TSD	Target Save Disable. When = 0, indicates that the target provides a target-defined method for saving log parameters. When = 1, indicates that either the target does not provide a defined method for saving log parameters or that the target-defined method has been disabled by the initiator.														
ETC	Enable Threshold Comparison. Threshold checking is not supported on this page. Always set to 0.														
TMC	Threshold Met Criteria. Always 0.														
LP	List Parameter. Always set to 0 (parameter codes treated as data counter).														

Table 5–33 Log Parameters for DEVICE STATUS LOG SENSE Page Field Descriptions

Bit	7	6	5	4	3	2	1	0
Byte	Reserved					ClnR	ClnQ	ClnEx
0	Reserved					ClnR	ClnQ	ClnEx
1 - 3	(MSB)	Reserved						(LSB)

Figure 5–33 Log Parameters Format for DEVICE STATUS LOG SENSE Page Parameter 0001h (Cleaning Related)

LOG SENSE Command (4Dh) (continued)

Field Name	Description
ClnR	Set to 1 if a cleaning required condition exists. When the condition clears, this status is also cleared.
ClnQ	Set to 1 if a cleaning request condition exists. When the condition clears, this status is also cleared.
ClnEx	Set to 1 if the cleaning tape has expired. If no cleaning tape is installed, this bit is cleared.

*Table 5–34 Log Parameters for DEVICE WELLNESS LOG SENSE Parameter 0001h
(Cleaning Related) Field Descriptions*

5.9. MODE SELECT Command (6) / (10) (15h / 55h)

The MODE SELECT command (available in either 6- or 10-byte format) enables the host to configure the tape drive. Implementing MODE SELECT and MODE SENSE requires “handshaking” between the host and the drive. Before configuring the drive, the host should issue a MODE SENSE command to the drive to obtain a report of the current configuration and determine what parameters are configurable. The host interprets this information and then may issue MODE SELECT to set the drive to the host’s preferred configuration. The Mode Parameter List described in Section 5.8 is passed from the initiator to the drive during the command’s DATA OUT phase.

Information for the drive is carried on a number of pages, each of which serves to set the tape drive’s operating parameters. The MODE SELECT pages supported, and the sections of this manual that details each page, are:

Page Code	Description	Described in Section.....
01h	READ/WRITE Error Recovery Page	5.9.2
02h	Disconnect / Reconnect Page	5.9.3
0Ah	Control Mode Page	5.9.4
0Fh	Data Compression Page	5.9.5
10h	Device Configuration Page	5.9.6
11h	Medium Partition Page	5.9.7
1Ch	TapeAlert Page	5.9.8
3Eh	EEPROM Vendor Unique Page	5.9.9

Except for mode page 3Eh, the tape drive always powers up with its default configurations set. This is also true if the drive receives a BUS DEVICE RESET message or a hard reset via the RST line on the SCSI bus.

The Command Descriptor Block is illustrated in Figure 5-34.

NOTE

For a list of changeable parameters within MODE SELECT, refer to Sections 5.9.9 (EEPROM Vendor Unique Page 3Eh) and 5.9.10.

*MODE SELECT Command (6) / (10) (15h) / (55h) (continued)***MODE SELECT (6) Command Descriptor Block — Data Format**

Bit	7	6	5	4	3	2	1	0
Byte								
0	Operation Code (15h)							
1	Logical Unit Number			PF	Reserved			SP (0)
2 - 3	Reserved							
4	Parameter List Length							
5	Unused		Reserved			Flag		Link

MODE SELECT (10) Command Descriptor Block — Data Format

Bit	7	6	5	4	3	2	1	0
Byte								
0	Operation Code (55h)							
1	Logical Unit Number			PF	Reserved			SP (0)
2 - 6	Reserved							
7 - 8	Parameter List Length							
9	Unused		Reserved			Flag		Link

Figure 5–34 MODE SELECT (6) and (10) Command Descriptor Blocks — Data Format

MODE SELECT Command (6) / (10) (15h) / (55h) (continued)

Field Name	Description
PF	Page Format. The Page Format bit indicates that the data sent by the host after the MODE SELECT header and block descriptors complies with the definition of pages in the SCSI-2 specification. The SCSI-1 format will not be implemented so this bit must be set to 1. It is an ILLEGAL REQUEST to have page parameters while the PF bit is 0.
SP	Save Parameters. Must be 0. If set, this bit instructs the drive to save all savable pages, and this is not supported on the tape drive.

*Table 5–35 MODE SELECT (6) (10) Command Descriptor Block — Field Descriptions***5.9.1. Mode Parameter List**

The figures below show the formats of the Mode Parameter List for MODE SELECT (6) and MODE SELECT (10) passed by the initiator to the tape drive during the command's DATA OUT phase.

Bit	7	6	5	4	3	2	1	0
Byte								
0 - 3	Mode Parameter Header							
4 - 11	Mode Parameter Block Descriptor (Optional)							
4 - 11 or 12 - n	Page(s) (Optional)							

Figure 5–35 MODE SELECT (6) Mode Parameter List — Data Format

MODE SELECT Command (6) / (10) (15h) / (55h) (continued)

Bit Byte	7	6	5	4	3	2	1	0
0 - 7	Mode Parameter Header							
8 - 15	Mode Parameter Block Descriptor (Optional)							
8 - n or 16 - n	Page(s) (Optional)							

Figure 5–36 MODE SELECT (10) Mode Parameter List — Data Format

Field Name	Description
Mode Parameter Header	Contains information about the remainder of the Parameter List and is always present (see Figure 5-37 and Table 5-37).
Mode Parameter Block Descriptor	Allows the initiator to set the drive's Logical Block Size and number of Descriptor Logical Block Addresses (see Figure 5-38 and Table 5-38).
Page(s)	The Page Code(s) of the pages that are a part of this MODE SELECT command.

Table 5–36 MODE SELECT (6) or (10) Mode Parameter List — Field Descriptions

*MODE SELECT Command (6) / (10) (15h) / (55h) (continued)***5.9.1.1. Mode Parameter Header**

The figures and tables that follow provide an illustration and description of the fields that make up the MODE SELECT (6) or (10) command's Mode Parameter header.

Bit Byte	7	6	5	4	3	2	1	0
0	Reserved							
1	Media Type							
2	Ignored	Buffered Mode			Speed			
3	Block Descriptor Length							

Figure 5–37 MODE SELECT (6) Mode Parameter Header — Data Format

Bit Byte	7	6	5	4	3	2	1	0
0 - 1	Reserved							
2	Media Type							
3	Ignored	Buffered Mode			Speed			
4 - 5	Reserved							
6 - 7	Block Descriptor Length							

Figure 5–38 MODE SELECT (10) Mode Parameter Header — Data Format

MODE SELECT Command (6) / (10) (15h) / (55h) (continued)

Field Name	Description
Media Type	This field is ignored by the MODE SELECT command.
Buffered Mode	<p>Default = 1. The drive implements immediate reporting on WRITE commands through its buffered mode. With Buffered Mode set to 1, the drive reports GOOD status on WRITE commands as soon as the data block has been transferred to the buffer. If this field = 0, then the drive does not report GOOD status on WRITE commands until the data blocks have been written to tape.</p> <p>When Buffered Mode is not used, the tape drive suffers significant performance degradation, and possible capacity, depending on tape format, block size, and compression. When using the 10 or 20 GB format with compression disabled and block size a multiple of 8 Kbytes, there is no capacity loss.</p> <p>When writing 10 , 15,20, or 40 GB format with compression enabled and Buffered Mode disabled, some capacity loss can occur. The block packing feature is essentially disabled by turning off Buffered Mode.</p> <p>If Buffered Mode is set to a number greater than 1, the command is rejected with CHECK CONDITION, sense key of ILLEGAL REQUEST.</p>
Speed	<p>The value of this field specifies the speed at which the drive will match the transfer rate of the host.</p> <p>The default setting = 0. Tape system will attempt to match the drive's throughput with the host data throughput.</p> <p>1 = Used for systems with bus speed below 5.0MB/second.</p> <p>2 = Used for systems with bus speeds between 5.0 and 6.0MB/second</p> <p>3 = Used for systems with bus speeds of 6.0MB/second or greater.</p> <p>NOTE: This information applies only to DLT8000 format.</p>
Block Descriptor Length	<p>This field specifies the length in bytes of all the block descriptors. Since the drive only allows one block description, the value must be either 0 or 8. A value of 0 indicates no block description is included; a value of 8 indicates a block descriptor is present and precedes the mode page data. Any other value other than 0 or 8 causes a CHECK CONDITION status with sense key of ILLEGAL REQUEST to be returned.</p>

Table 5-37 Mode Parameter Header — Field Descriptions

*MODE SELECT Command (6) / (10) (15h) / (55h) (continued)***5.9.1.2 . Mode Parameter Block Descriptor**

The figure and table that follow provide an illustration and description of the fields that make up the MODE SELECT command's Mode Parameter Block Descriptor.

Bit	7	6	5	4	3	2	1	0
Byte								
0	Density Code							
1 - 3	(MSB)	Number of Blocks						(LSB)
4	Reserved							
5 - 7	(MSB)	Block Length						(LSB)

Figure 5-39 Mode Parameter Block Descriptor — Data Format

MODE SELECT Command (6) / (10) (15h) / (55h) (continued)

Field Name	Description
Density Code	This field should match the current tape medium density; it is set to 0 if the density is unknown. Density
	Code Description
	00h Use default density
	19h 62500 bpi, 64 track pairs, serial cartridge tape – 10.0 GB (DLTtape III) / 15.0 GB (DLTtape IIIXT)
	1Ah 81633 bpi, 64 track pairs, serial cartridge tape – 20.0 GB (DLTtape IV)
	1Bh 85937 bpi, 52 track quads, serial cartridge tape – 35.0 GB (DLTtape IV)
	41h 98250 bpi, 52 track quads, serial cartridge tape – 40.0 GB (DLTtape IV)
	 The density codes above are the preferred codes used to define density. Additionally, the codes listed below may be used, though use of the Data Compression Page is preferred:
	7Fh No change from previous density (No Operation)
	80h 62500 bpi, 64 track pairs, serial cart.tape - 10.0 GB (DLTtape III) / 15.0GB (DLTtape IIIXT) without compression
	81h 62500 bpi, 64 track pairs, serial cart.tape - 20.0 GB (DLTtape III) / 30.0GB (DLTtape IIIXT) with compression
	82h 81633 bpi, 64 track pairs, serial cart.tape - 20.0 GB (DLTtape IV) without compression
	83h 81633 bpi, 64 track pairs, serial cart.tape - 40 GB (DLTtape IV) with compression
	84h 85937 bpi, 52 track quads, serial cartridge tape - 35 GB (DLTtape IV) without compression
	85h 85937 bpi, 52 track quads, serial cartridge tape - 70 GB (DLTtape IV) with compression
	88h 98250 bpi, 52 track quads, serial cartridge tape - 40 GB (DLTtape IV) without compression
	89h 98250 bpi, 52 track quads, serial cartridge tape - 80 GB (DLTtape IV) with compression
Number of Blocks	This MODE SENSE field is sent = 0, indicating that all of the remaining logical blocks on the tape will have the medium characteristics specified by the block descriptor.

Table 5–38 Mode Parameter Block Descriptor — Field Descriptions

MODE SELECT Command (6) / (10) (15h) / (55h) (continued)

Field Name	Description
Block Length	This field specifies the length, in bytes, of each logical block transferred over the SCSI bus. A block length of 0 indicates that the length is variable (specified in the I/O command). Any value other than 0 indicates the number of bytes per block to use for READ, WRITE, and VERIFY commands that specify a “fixed” bit of 1 (i.e., fixed block mode) which also causes the transfer length in the command descriptor block to be defined as a block count. If fixed bit is not equal to 1, this field is ignored.

*Table 5–38 Mode Parameter Block Descriptor — Field Descriptions (continued)***5.9.1.3 . Mode Page Descriptors**

Following the MODE SELECT command’s Mode Parameter Block Descriptor are the MODE SELECT pages, each of which sets a different device parameter. Each mode page has a 2-byte header that identifies the page code and indicates the number of bytes in that page.

Bit Byte	7	6	5	4	3	2	1	0
0	PS (0)	0	Page Code					
1	Additional Page Length							
2 - n	Page-Defined or Vendor Unique Parameter List							

Figure 5–40 MODE SELECT Page Descriptor — Data Format

Field Name	Description
PS	Parameters Savable. For the MODE SELECT (6) (10) commands, this field is reserved (0).
Additional Page Length	Indicates number of bytes in that page (not including bytes 0 and 1).
Page-Defined or Vendor Unique Parameter List	Information in this field depends on the mode page. Refer to Sections 5.9.2 through 5.9.9.

Table 5–39 MODE SELECT Page Descriptor — Field Descriptions

MODE SELECT Command (6) / (10) (15h) / (55h) (continued)

5.9.2. READ / WRITE ERROR RECOVERY PAGE (01h)

The READ / WRITE Error Recovery Page controls the drive's response to error conditions that arise during the course of READ and WRITE command processing.

Bit	7	6	5	4	3	2	1	0
Byte								
0	PS (0)	0	Page Code (01h)					
1	Additional Page Length (0Ah)							
2	Rsv'd	Rsv'd	TB	Rsv'd	EER (1)	PER	DTE (0)	DCR (0)
3	Read Retry Count							
4 - 7	Reserved							
8	Write Retry Count							
9 - 11	Reserved							

Figure 5–41 READ/WRITE Error Recovery Page — Data Format

MODE SELECT Command (6) / (10) (15h) / (55h) (continued)

Field Name	Description
PS	Parameters Savable. For MODE SELECT, this bit must be 0.
Additional Page Length	<p>This field indicates the number bytes in the page. However, the value does not include bytes 0 and 1. The length is returned in MODE SENSE commands and must subsequently be set to the same value when performing MODE SELECT. If the page length does not match that expected by the drive, a CHECK CONDITION status is returned, sense key set to ILLEGAL REQUEST.</p> <p>The drive returns a CHECK CONDITION status with sense key set to ILLEGAL REQUEST if it receives an unsupported Page Code or a Page field with values not supported or changeable. In such cases, no parameters are changed as a result of the command.</p>
TB	Transfer Block. Not supported.
EER	Enable Early Recovery. Set to 1 (always enabled).
PER	Post Error. Default is 0. When set to 1, this bit enables reporting of Check Condition to report recovered READ / WRITE errors.
DTE	Disable Transfer on Error. Must be 0. Not supported.
DCR	Disable ECC Correction. Must be 0. Not supported.
Read Retry Count	This field reports the maximum number or rereads that are attempted before declaring an unrecoverable error.
Write Retry Count	This field reports the maximum number of overwrite retries that will be attempted before declaring an unrecoverable error.

Table 5–40 READ/WRITE Error Recovery Page — Field Descriptions

MODE SELECT Command (6) / (10) (15h) / (55h) (continued)

5.9.3. **DISCONNECT / RECONNECT PAGE (02h)**

The Disconnect / Reconnect Page controls the drive's behavior on the SCSI bus and allows an initiator to tune bus performance.

Bit	7	6	5	4	3	2	1	0
Byte								
0	PS (0)	0	Page Code (02h)					
1	Additional Page Length (0Eh)							
2	Buffer Full Ratio							
3	Buffer Empty Ratio							
4 - 5	(MSB)	Bus Inactivity Limit						(LSB)
6 - 7	(MSB)	Disconnect Time Limit						(LSB)
8 - 9	(MSB)	Connect Time Limit						(LSB)
10 - 11	(MSB)	Maximum Burst Time						(LSB)
12	Reserved						DTDC	
13 - 15	Reserved							

Figure 5–42 Disconnect / Reconnect Page — Data Format

MODE SELECT Command (6) / (10) (15h) / (55h) (continued)

Field Name	Description										
PS	Parameters Savable. For MODE SELECT, this bit must be 0.										
Additional Page Length	<p>This field indicates the number bytes in the page. However, the value does not include bytes 0 and 1. The length is returned in MODE SENSE commands and must subsequently be set to the same value when performing MODE SELECT. If the page length does not match that expected by the drive, a CHECK CONDITION status is returned, sense key set to ILLEGAL REQUEST.</p> <p>The drive returns a CHECK CONDITION status with sense key set to ILLEGAL REQUEST if it receives an unsupported Page Code or a Page field with values not supported or changeable. In such cases, no parameters are changed as a result of the command.</p>										
Buffer Full Ratio	Not supported. Any value is ignored.										
Buffer Empty Ratio	Not supported. Any value is ignored.										
Bus Inactivity Limit	Not supported. Any value is ignored.										
Disconnect Time Limit	Not supported. Any value is ignored.										
Connect Time Limit	Not supported. Any value is ignored.										
Maximum Burst Size	This value specifies the maximum amount of data that will be transferred without disconnecting. A value of 0 sets no limit. Any value is in units of 512 bytes. For example, a value of 8 represents 4 Kbytes. Values that are not multiples of 8 are rounded up to the closest multiple of 8.										
DTDC	<p>Data Transfer Disconnect Control. This field defines further restrictions for when disconnect is permitted.</p> <table border="1"> <thead> <tr> <th>DTDC</th> <th>Description</th> </tr> </thead> <tbody> <tr> <td>00b</td> <td>Data transfer disconnect control is not used. Disconnect is controlled by the other fields in this page.</td> </tr> <tr> <td>01b</td> <td>Once the data transfer of a command has been started a target does not attempt to disconnect until all the data to be transferred has been transferred.</td> </tr> <tr> <td>10b</td> <td>Reserved.</td> </tr> <tr> <td>11b</td> <td>Once the data transfer of a command has started, a target does not attempt to disconnect until the command is complete.</td> </tr> </tbody> </table> <p>If DTDC is a non-zero value and the maximum burst size is non-zero, the tape drive returns CHECK CONDITION status, sense key set to ILLEGAL REQUEST and additional sense code set to ILLEGAL FIELD IN PARAMETER LIST.</p>	DTDC	Description	00b	Data transfer disconnect control is not used. Disconnect is controlled by the other fields in this page.	01b	Once the data transfer of a command has been started a target does not attempt to disconnect until all the data to be transferred has been transferred.	10b	Reserved.	11b	Once the data transfer of a command has started, a target does not attempt to disconnect until the command is complete.
DTDC	Description										
00b	Data transfer disconnect control is not used. Disconnect is controlled by the other fields in this page.										
01b	Once the data transfer of a command has been started a target does not attempt to disconnect until all the data to be transferred has been transferred.										
10b	Reserved.										
11b	Once the data transfer of a command has started, a target does not attempt to disconnect until the command is complete.										

Table 5–41 Disconnect / Reconnect Page — Field Descriptions

MODE SELECT Command (6) / (10) (15h) / (55h) (continued)

5.9.4. CONTROL MODE PAGE (0Ah)

The Control Mode Page provides control over several features such as tagged queuing, extended contingent allegiance, asynchronous event notification, and error logging.

Bit	7	6	5	4	3	2	1	0
Byte								
0	PS (0)	Rsv'd	Page Code (0Ah)					
1	Page Length (06)							
2	Reserved							RLEC
3	Queue Algorithm Modifier (0)				Reserved		Qerr (0)	DQue (0)
4	EECA (0)	Reserved				RAENP (0)	UAAENP (0)	EAENP
5	Reserved							
6 - 7	(MSB)	Ready AEN Holdoff Period (0)						(LSB)

Figure 5–43 Control Mode Page Format Descriptor — Data Format

MODE SELECT Command (6) / (10) (15h) / (55h) (continued)

Field Name	Description
PS	Parameters Savable. For MODE SELECT, this bit must be 0.
Page Length	The Page Length field indicates the number of bytes in the Control Mode Page that follow this byte. The valid value for this byte is 06h.
RLEC	Report Log Exception Condition. When set to 1, specifies that the target will report log exception conditions. When 0, specifies that the target will not report log exception conditions. The RLEC bit works in conjunction with the READ / WRITE Error Log Sense Page, specifically, the TMC bit of the READ / WRITE Error Log SENSE Page (Page 2 and 3), described earlier in this manual. The RLEC bit indicates whether the drive should return CHECK CONDITION status with sense key set to UNIT ATTENTION when one of the READ and WRITE error counters of the log pages reach a specified threshold . Thresholds can be modified using LOG SELECT.
Queue Algorithm Modifier	Must be 0.
Qerr	Queue Error. Must be 0.
DQue	Disable Queuing. Must be 0.
EECA	Enable Extended Contingent Allegiance. Not supported; must be 0.
RAENP	Ready Asynchronous Event Notification. Not supported; must be 0.
UAAENP	Unit Attention Asynchronous Event Notification. Not supported; must be 0.
EAENP	Enable AEN Permission. Asynchronous event notification is not supported; must be 0.
Ready AEN Holdoff Period	Not supported; must be 0.

Table 5–42 Control Mode Page Descriptor — Field Descriptions

MODE SELECT Command (6) / (10) (15h) / (55h) (continued)

5.9.5. DATA COMPRESSION PAGE (0Fh)

The Data Compression page specifies parameters for the control of data compression. This page allows the user to turn the tape drive's compressed format on and off independently of the tape medium's position.

Bit	7	6	5	4	3	2	1	0
Byte								
0	Reserved		Page Code (0Fh)					
1	Page Length (0Eh)							
2	DCE	DCC (1)	Reserved					
3	DDE (1)	RED (00)		Reserved				
4 - 7	(MSB) Compression Algorithm (10) (LSB)							
8 - 11	(MSB) Decompression Algorithm (10) (LSB)							
12 - 15	Reserved							

Figure 5-44 Data Compression Page Format Descriptor — Data Format

MODE SELECT Command (6) / (10) (15h) / (55h) (continued)

Field Name	Description
Page Code	The Page Code identifies the type of MODE SELECT page being transferred. A value of 0Fh identifies this as the Data Compression page.
Page Length	The Page Length field indicates the number of bytes in the Data Compression page that follow this byte. The valid value for this byte is 0Eh.
DCE	Data Compression Enable. This bit specifies whether the tape drive should enable or disable data compression. When set to 1, the drive starts in compressed format.
DCC	Data Compression Capable. This bit is used by the MODE SENSE command to indicate that the tape drive supports data compression.
DDE	Data Decompression Enable. Must be set to 1. When the tape drive reads compressed data from tape, it automatically decompresses the data before sending it to the initiator. Data compression must always be enabled.
RED	Report Exception on Decompression. The tape drive does not report exceptions on decompression (boundaries between compressed and uncompressed data). The RED field must be 00h.
Compression Algorithm	<p>The Compression Algorithm field indicates which compression algorithm the tape drive will use to process data from the initiator when the DCE bit (byte 02, bit 7) is set to 1. The only value currently supported for this field is 10h.</p> <p>NOTE: Specifying a value other than 10h for this field causes the tape drive to return CHECK CONDITION status, sense key set to ILLEGAL REQUEST. However, if EEPROM parameter EnaRepDecomp is set, the parameter in this field is ignored and no CHECK CONDITION status is returned.</p>
Decompression Algorithm	<p>The Decompression Algorithm field indicates which decompression algorithm the tape drive will use when decompressing data on the tape. The only value currently supported is 10h.</p> <p>NOTE: Specifying a value other than 10h for this field causes the tape drive to return CHECK CONDITION status, sense key set to ILLEGAL REQUEST.</p>

Table 5–43 Data Compression Page Descriptor — Field Descriptions

MODE SELECT Command (6) / (10) (15h) / (55h) (continued)

5.9.6. **DEVICE CONFIGURATION PAGE (10h)**

The Device Configuration Page controls the drive's behavior on the SCSI bus and allows an initiator to tune bus performance.

Bit	7	6	5	4	3	2	1	0
Byte								
0	PS (0)	0	Page Code (10h)					
1	Additional Page Length (0Eh)							
2	Res'd	CAP (0)	CAF (0)	Active Format (0)				
3	Active Partition (0)							
4	Write Buffer Full Ratio							
5	Read Buffer Empty Ratio							
6 - 7	(MSB) Write Delay Time (LSB)							
8	DBR (0)	BIS	RSmk (0)	AVC (0)	SOCF (0)	RBO (0)	REW (0)	
9	Gap Size (0)							
10	EOD Defined (0)			EEG	SEW (1)	Reserved		
11 - 13	(MSB) Buffer Size at Early Warning (0) (LSB)							
14	Select Data Compression Algorithm							
15	Reserved							

Figure 5–45 Device Configuration Page — Data Format

MODE SELECT Command (6) / (10) (15h) / (55h) (continued)

Field Name	Description
PS	Parameters Savable. For MODE SELECT, this bit must be 0.
Additional Page Length	<p>This field indicates the number bytes in the page. However, the value does not include bytes 0 and 1. The length is returned in MODE SENSE commands and must subsequently be set to the same value when performing MODE SELECT. If the page length does not match that expected by the drive, a CHECK CONDITION status is returned, sense key set to ILLEGAL REQUEST.</p> <p>The drive returns a CHECK CONDITION status with sense key set to ILLEGAL REQUEST if it receives an unsupported Page Code or a Page field with values not supported or changeable. In such cases, no parameters are changed as a result of the command.</p>
CAP	Change Active Partition. Not supported; must be 0.
CAF	Change Active Format. Not supported; must be 0.
Active Format	Not supported. Must be 0.
Active Partition	Only partition 0 is supported. Setting this field to any other value causes rejection by the drive with a CHECK CONDITION status, sense key ILLEGAL REQUEST set.
Write Buffer Full Ratio	The drive sets this field to 0. The drive uses an automatic adaptive mechanism to adjust its Full Ratio according to the average data rates over the SCSI bus.
Read Buffer Empty Ratio	The drive sets this field to 0. The drive uses an automatic adaptive mechanism to adjust its Empty Ratio according to the average data rates over the SCSI bus.
Write Delay Time	<p>This field indicates the maximum time that the drive will wait with a partially full buffer before forcing the data to tape (100 ms increments). The buffer Full/Empty ratio, which is dynamic, can cause data to be written sooner than the Write Delay Time would indicate. The Write Delay Time defaults to 200 (C8h). This causes the buffer to be flushed in 20 seconds. Maximum value is 6500 (1964h) and the minimum is 15 (0Fh). This represents a range from 11 minutes down to 1.5 seconds.</p> <p>Values between 0 and 15 on a MODE SELECT, are rounded down to 0. This causes the data to go straight to the medium without delay.</p>
DBR	Data Buffer Recovery. Not supported, must be 0.
BIS	Block Identifiers Supported. This field is supported. Set to 1.
RSmk	Report Setmark. Not supported, must be 0.

Table 5-44 Device Configuration Page — Field Descriptions

MODE SELECT Command (6) / (10) (15h) / (55h) (continued)

Field Name	Description
AVC	Automatic Velocity Control. Not supported; must be 0.
SOCF	Stop on Consecutive Filemarks. Not supported; must be 0.
RBO	Recover Buffer Order. Not supported; must be 0.
REW	Report Early Warning. Not supported; must be 0 (do not report Early Warning EOM on READ).
Gap Size	Not used; must be 0.
EOD Defined	End-of-Data Defined. This field must be set to 00h.
EEG	Enable End-of-Data Generation. Set to 1. This field indicates that the drive will generate an EOD. The drive generates an EOD mark before any change of direction following a WRITE-type operation. This bit is ignored, however, on MODE SELECT.
SEW	Synchronize at Early Warning. Must be set to 1.
Buffer Size at Early Warning	Not supported; must be 0.
Select Data Compression Algorithm	When set to 1, enables data compression. When 0, disables data compression. The setting on the front panel of the tape drive overrides any setting of MODE SELECT, but no error will result. If the setting is returned to the automatic mode on the front panel of the tape drive, the value from the last MODE SELECT command determines whether compression is enabled or disabled.

Table 5–44 Device Configuration Page — Field Descriptions (continued)

MODE SELECT Command (6) / (10) (15h) / (55h) (continued)

5.9.7. MEDIUM PARTITION PAGE (11h)

The drive supports the Medium Partition Parameters Page which is used to specify the medium partitions.

Bit	7	6	5	4	3	2	1	0
Byte								
0	PS (0)	0	Page Code (11h)					
1	Additional Page Length (06)							
2	Maximum Additional Partitions (0)							
3	Additional Partitions Defined (0)							
4	FDP (0)	SDP (0)	IDP (0)	PSUM (0)		Reserved		
5	Medium Format Recognition (01)							
6 - 7	Reserved							

Figure 5–46 Medium Partition Page Format Descriptor — Data Format

MODE SELECT Command (6) / (10) (15h) / (55h) (continued)

Field Name	Description
PS	Parameters Savable. For MODE SELECT, this bit must be 0.
Additional Page Length	<p>This field indicates the number bytes in the page. However, the value does not include bytes 0 and 1. The length is returned in MODE SENSE commands and must subsequently be set to the same value when performing MODE SELECT. If the page length does not match that expected by the drive, a CHECK CONDITION status is returned, sense key set to ILLEGAL REQUEST.</p> <p>The drive returns a CHECK CONDITION status with sense key set to ILLEGAL REQUEST if it receives an unsupported Page Code or a Page field with values not supported or changeable. In such cases, no parameters are changed as a result of the command.</p>
Maximum Additional Partitions	Not supported. Must be 0.
Additional Partitions Defined	Must be 0. This field specifies the number of additional partitions to be defined for the tape based on the settings of the SDP and IDP bits. The maximum allowed is the value returned in the Maximum Additional Partitions field. Only one partition is supported, therefore the value of the field must be 0.
FDP	Fixed Data Partitions. Must be 0.
SDP	Select Data Partitions. Must be 0.
IDP	Initiator Defined Partitions. Must be 0.
PSUM	Partition Size Unit of Measure. Must be 0.
Medium Format Recognition	This field is valid for MODE SENSE only, and is set to 01h, indicating that Medium Format Recognition is supported.

Table 5–45 Medium Partition Page Descriptor — Field Descriptions

*MODE SELECT Command (6) / (10) (15h) / (55h) (continued)***5.9.8. TAPEALERT PAGE (1Ch)**

The drive supports the TapeAlert Page which is used to set/change the supported TapeAlert configuration options (use the MODE SENSE command to read the settings of the TapeAlert page).

Bit	7	6	5	4	3	2	1	0
Byte								
0	PS (0)	0	Page Code (1Ch)					
1	Additional Page Length (0A)							
2	Perf = 0	Reserved			DExcpt = 1	Test	Rsvd	LogErr
3	Reserved				MRIE			
4 – 7	(MSB) Interval Timer (LSB)							
8 – 11	(MSB) Report Count / Test Flag Number (LSB)							

Figure 5–47 TapeAlert Page Format Descriptor — Data Format

MODE SELECT Command (6) / (10) (15h) / (55h) (continued)

Field Name	Description
PS	Parameters Savable. For MODE SELECT, this bit must be 0.
Additional Page Length	<p>This field indicates the number bytes in the page. However, the value does not include bytes 0 and 1. The length is returned in MODE SENSE commands and must subsequently be set to the same value when performing MODE SELECT. If the page length does not match that expected by the drive, a CHECK CONDITION status is returned, sense key set to ILLEGAL REQUEST.</p> <p>The drive returns a CHECK CONDITION status with sense key set to ILLEGAL REQUEST if it receives an unsupported Page Code or a Page field with values not supported or changeable. In such cases, no parameters are changed as a result of the command.</p>
Perf	Performance bit. Not supported.; always = 0.
DExcpt	Disable Information Exception Operations. If = 0, the reporting method specified by the contents of MRIE is selected. When this bit = 1, all information exception operations are disabled and the contents of the MRIE field are ignored. When in this mode, the TapeAlert Log page is polled by the software. To enable CHECK CONDITION mode, DExcpt should = 0. Default setting = 1.
Test	Test Bit. Not supported.
LogErr	Error Log. Not supported

Table 5–46 TapeAlert Page Format Descriptor — Field Descriptions

MODE SELECT Command (6) / (10) (15h) / (55h) (continued)

Field Name	Description								
MRIE	<p>Method for Reporting Informational Exceptions. The tape drive uses the contents of this field to report information about exception conditions. Three methods are available:</p> <table border="1"> <thead> <tr> <th><u>Value</u></th> <th><u>Method</u></th> </tr> </thead> <tbody> <tr> <td>00h</td> <td>No reporting of Informational Exception Conditions. The device server does not report information exception conditions.</td> </tr> <tr> <td>03h</td> <td>Conditionally Generate Recovered Error. The device server reports informational exception conditions, if such reports of recovered errors is allowed, by returning CHECK CONDITION status on the next SCSI command (except INQUIRY and REQUEST SENSE commands) following detection of the condition. The Sense Key is set to RECOVERED ERROR with an additional sense code of 5D 00 (TapeAlert Event). The SCSI command with CHECK CONDITION completes without error prior to the report of any exception condition, and does not need to be repeated.</td> </tr> <tr> <td>06h</td> <td>Only Report Informational Exception Condition on Request. The device server preserves information exception data. To access the data, a poll can be taken by issuing an unsolicited REQUEST SENSE command. The Sense Key is set to NO SENSE with an additional sense code of 5D 00 (TapeAlert Event).</td> </tr> </tbody> </table> <p>The additional sense code of 5D 00 for values 03h and 06h signals that a TapeAlert event has occurred. Information about the event is stored in the TapeAlert Log Page. The setting of MRIE does not impact logging of events in the TapeAlert Log Page.</p>	<u>Value</u>	<u>Method</u>	00h	No reporting of Informational Exception Conditions. The device server does not report information exception conditions.	03h	Conditionally Generate Recovered Error. The device server reports informational exception conditions, if such reports of recovered errors is allowed, by returning CHECK CONDITION status on the next SCSI command (except INQUIRY and REQUEST SENSE commands) following detection of the condition. The Sense Key is set to RECOVERED ERROR with an additional sense code of 5D 00 (TapeAlert Event). The SCSI command with CHECK CONDITION completes without error prior to the report of any exception condition, and does not need to be repeated.	06h	Only Report Informational Exception Condition on Request. The device server preserves information exception data. To access the data, a poll can be taken by issuing an unsolicited REQUEST SENSE command. The Sense Key is set to NO SENSE with an additional sense code of 5D 00 (TapeAlert Event).
<u>Value</u>	<u>Method</u>								
00h	No reporting of Informational Exception Conditions. The device server does not report information exception conditions.								
03h	Conditionally Generate Recovered Error. The device server reports informational exception conditions, if such reports of recovered errors is allowed, by returning CHECK CONDITION status on the next SCSI command (except INQUIRY and REQUEST SENSE commands) following detection of the condition. The Sense Key is set to RECOVERED ERROR with an additional sense code of 5D 00 (TapeAlert Event). The SCSI command with CHECK CONDITION completes without error prior to the report of any exception condition, and does not need to be repeated.								
06h	Only Report Informational Exception Condition on Request. The device server preserves information exception data. To access the data, a poll can be taken by issuing an unsolicited REQUEST SENSE command. The Sense Key is set to NO SENSE with an additional sense code of 5D 00 (TapeAlert Event).								
Interval Timer	Not supported.								
Report Count / Test Flag Number	Not supported.								

Table 5–46 TapeAlert Page Format Descriptor — Field Descriptions (continued)

MODE SELECT Command (6) / (10) (15h) / (55h) (continued)

5.9.9. EEPROM VENDOR UNIQUE PAGE (3Eh)

The drive supports a vendor unique page that enables a user to modify savable parameters. Only one savable parameter may be changed per Mode Select command.

Bit	7	6	5	4	3	2	1	0
Byte								
0	PS	Rsv'd	Page Code (3Eh)					
1	Additional Page Length							
2	ASCII String of Parameter Name and Value							

Figure 5–48 EEPROM Vendor Unique Page — Data Format

The ASCII string has a parameter name, followed by one or more space characters, a parameter value, and an ASCII line feed or null character. When the string is parsed, the parameter value is interpreted as shown in the following table. Note that the parameter name may be in upper or lower case. The saveable parameters are saved over resets and power cycles.

MODE SELECT Command (6) / (10) (15h) / (55h) (continued)

Name	Value Rep.	Default	Length (Bytes)	Usage
VENDORID	ASCII	TANDBERG	8	Vendor Identification field in INQUIRY Data
PRODUCTID	ASCII	DLT8000	16	Product Identification field in INQUIRY Data
FORCEDENSITY ¹	ASCII Decimal	0	1	0 = automatic ² 3 = DLT2000 4 = DLT4000 5 = DLT2000XT 6 = DLT7000 7 = DLT8000
FORCECOMP	ASCII Binary	0	1	0 = automatic ² 1 = Never compress unless front panel selection enables it 2 = Always compress unless front panel selection disables it
DEFAULTCOMPON	ASCII Binary	1	1	0 = Compression defaulted OFF on powerup/reset 1 = Compression defaulted ON on powerup/reset
DEFIXEDBLKEN	ASCII Decimal	0	8	Default fixed block size
ENBINQMEDCHGR	ASCII Binary	0	1	0 = Disable media changer bit. 1 = Enable media changer bit in byte 6 of INQUIRY data (set if drive is in a media changer device)

NOTES:

1. Applied to DLTtape III format tape DLT2000XT drive. Applied to DLTtape IV format tape for DLT4000, DLT7000, and DLT8000 drive.
2. Parameter is not forced to a special format. Instead it is determined by the parameters selected via MODE SELECT.

Table 5–47 EEPROM Vendor Unique Page Parameters

MODE SELECT Command (6) / (10) (15h) / (55h) (continued)

Name	Value Rep.	Default	Length (Bytes)	Usage
LOADERLUN	ASCII Decimal	1	1	1 - 7 = LUN to report media loader device on.
REWINDONRESET	ASCII Binary	1	1	0 = Do not rewind on BUS RESET or BDR message (CAUTION: May have partial block data written to tape if reset occurs during WRITE). 1 = Rewind the tape medium to BOT on reset.
ENALDRAUTOLD	ASCII Binary	1	1	To turn on/off sequential loading with loader
DISLDRAUTODMC	ASCII Binary	1	1	To partially disable sequential loading with loader if any media loader command has been received.
ENAPARERRRETRY	ASCII Binary	0	1	To turn on/off parity error retry feature
ENAMODEPG22	ASCII Binary	0	1	To enable vendor unique Data Compression (Status Mode Page)
NODISCONFXDBLK	ASCII Binary	1	1	To turn on/off feature that prevents disconnecting on every fixed block data transfer
PROTECTDIRONWP	ASCII Binary	0	1	To protect tape directory if the cartridge write-protect switch is in its write protect position.
ENACLNGLTRPT	ASCII Binary	1	1	To report error status if cleaning indicator is on.
LONGXPORTPAGE	ASCII Binary	1	1	To report 18 or 6 bytes medium transport element status descriptor if parameter is on or off.
SCSIINQVS	ASCII Binary	0	1	To return vendor unique inquiry string, if set.
DEFSEW	ASCII Binary	1	1	To set default SEW parameter.
ENAINITSYNENEG	ASCII Binary	0	1	To enable target-initiated synchronous negotiation, if set.
REPORTRCVDPERRS	ASCII Binary	1	1	To report recovered error if parity error has been retried successfully, if set.
ENATHIRDPTYDENS	ASCII Binary	1	1	To make non-DLT density code act as the default density (same as density code 0), if set.

Table 5-47 EEPROM Vendor Unique Page Parameters (continued)

MODE SELECT Command (6) / (10) (15h) / (55h) (continued)

Name	Value Rep.	Default	Length (Bytes)	Usage
FORCEREADSILI	ASCII Binary	0	1	To make variable READ command handled as if the SILI bit is set if set.
CACHETMS	ASCII Decimal	0	1	0,1 = Do not cache filemarks unless IMMED bit is set (if set) 2 = Cache if not two in a row unless IMMED bit is 1. 3 = Always cache filemarks.
LDRCYCLRESET	ASCII Binary	0	1	To cause the first cartridge to be loaded if unloading the last cartridge when the loader product is operated in sequential mode (if set).
ENAREPDECOMP	ASCII Binary	0	1	If set and the drive is in READ mode, the decompression algorithm field in Data Compression mode will be reset if the last block requested by the host was decompressed, otherwise it is cleared.
SCSIRESRELNOP	ASCII Binary	0	1	SCSI Reserve / Release Unit commands are no operation (if set).
DISUNBUFMODE	ASCII Binary	0	1	The drive disables unbuffered mode, i.e., it ignores the MODE SELECT "buffered mode" selection to turn off buffered mode (if set).
NODEFERRCVDERR	ASCII Binary	0	1	The drive reports deferred recovered error as current recovered error (if set).
CALRETRY	ASCII Decimal	2	1	0 = no retry 1 = one retry 2 = 2 retries 3 = 3 retries

Table 5–47 EEPROM Vendor Unique Page Parameters (continued)

MODE SELECT Command (6) / (10) (15h) / (55h) (continued)

Name	Value Rep.	Default	Length (Bytes)	Usage
SCSIBUSDMATIMER	ASCII Decimal	2	1	The number of seconds until the drive times out waiting for ACK once DMA transfer started. When set to 0, the timer is set to infinite.
SCSIRESELRETRIES	ASCII Decimal	10	1	The number of reselection retries the drive makes before giving up. Each reselection retry occurs every 1 second. When set to 0, the drive does infinite reselection retries.
SCSIRDYEARLY	ASCII Binary	0	1	The drive reports READY status earlier (if set).
REPORTRCVRDERR	ASCII Binary	0	1	This parameter sets the default value of PER bit of READ / WRITE Error Recovery Mode page (01h).
NORDYUAONUNLD	ASCII Binary	0	1	When set, Not Ready to Ready Transition unit attention will be removed from the unit attention queue upon a successful unload.
HOSTCOMPSETTING	ASCII Decimal	0	1	This parameter allows the host to change the compression setting. Note that there is a tradeoff between best performance and best compression; if the compression setting = 1, it provides the best performance but the worst level of compression. If the setting = 15, it provides lowest performance but maximum compression. Settings for the HOSTCOMPSETTING parameter are: 0 Use default compression setting 1 Set compression setting for best performance 2 Set compression setting for best compromise of performance and compression 3 Set compression setting for best compression NOTE: This information for DLT8000 format only
REDUNDANCYMODE	ASCII Decimal	0	1	Sets the value of the allowed maximum marginal channel (0 - 1 allowed).
REPBUSYINPROG	ASCII Binary	0	1	When set, report busy status if the drive is in the process of becoming ready.

Table 5-47 EEPROM Vendor Unique Page Parameters (continued)

Name	Value Rep.	Default	Length (Bytes)	Usage
THIRDPARTYDEN	ASCII Decimal	0	1	Value of default third party density. Requires ENATHIRDPARTYDENS = 1
ENAGRANULARITY	ASCII Binary	1	1	Enables granularity field in READ BLOCK LIMITS command.
ENASCIFILTER	ASCII Binary	1	1	Enables SCSI filter on SCSI chip.
ENAREQACKACTNEG	ASCII Binary	1	1	Enables active negation on REQ and ACK signals
SETEOMATBOM	ASCII Binary	0	1	Sets EOM field in byte 2 of Request Sense data when encountering BOM
SETEOMATEW	ASCII Binary	0	1	Sets EOM field in byte 2 of Request Sense data when encountering Early Warning end of media for all operations
REPUAONSEQUNLD	ASCII Binary	0	1	When set, the drive reports a Not Ready to Ready Transition Unit Attention when an autoloader loads the next cartridge
DISDEFERCLNRPT	ASCII Binary	0	1	When set, a cleaning report is sent over the library port as soon as the cleaning light illuminates. If this parameter = 0, then the report is sent only at unload.
ENASCSIUNLONPMR	ASCII Binary	0	1	When set, enables a SCSI Unload when a previous Prevent Media Removal command is in effect
MAXBURSTSIZE	ASCII Binary	0080h	2	The value in this field specifies the maximum amount of data to be transferred without disconnecting. A value of 0 sets no limit. This value is given in 512 byte increments. For example, a value of 8 indicates 4K bytes. Values that are not multiples of 8 are rounded up to the nearest multiple of 8. Minimum value of this field is 0000h, maximum is FFFFh.
SPEEDSETTING	ASCII Decimal	3	1	0 = Drive will match host bus speed 1 = Bus Speed Below 5.0 MB/sec 2 = Bus Speed 5.0 – 6.0 MB/sec 3 = Bus Speed of 6.0 MB/sec or more NOTE: This information applies only to DLT8000 format.
TAMRIEDEFAULT	ASCII Binary	3	1	The value in this field is the value to be set in the Tape Alert Mode Page (1Ch) MRIE parameter. Minimum value is 0; maximum value is 6.

Table 5–47 EEPROM Vendor Unique Page Parameters (continued)

MODE SELECT Command (6) / (10) (15h) / (55h) (continued)

As an example of an EEPROM vendor unique page, the figure below shows a page that will modify the VENDORID parameter to “XXXYY.”

0	0	0	Page Code (3Eh)
1	Page Length (0Fh)		
2	“v” (76h)		
3	“e” (65h)		
4	“n” (6Eh)		
5	“d” (64h)		
6	“o” (6Fh)		
7	“r” (72h)		
8	“i” (69h)		
9	“d” (64h)		
10	“ ” (20h)		
11	“X” (58h)		
12	“X” (58h)		
13	“X” (58h)		
14	“Y” (59h)		
15	“Y” (59h)		
16	<LF> (A0h) or (00h)		

Figure 5–49 EEPROM Vendor Unique Page “Vendor ID” Sample — Data Format

MODE SELECT Command (6) / (10) (15h) / (55h) (continued)

An example follows that illustrates an EEPROM vendor unique page that modifies the FORCEDENSITY parameter to 4.

0	0	0	Page Code (3Eh)
1	Page Length (0Fh)		
2	"F" (46h)		
3	"O" (4Fh)		
4	"R" (52h)		
5	"C" (43h)		
6	"E" (45h)		
7	"D" (44h)		
8	"E" (45h)		
9	"N" (4Eh)		
10	"S" (53h)		
11	"I" (49h)		
12	"T" (54h)		
13	"Y" (59h)		
14	" " (20h)		
15	"4" (34h)		
16	<LF> (A0h) or (00h)		

Figure 5–50 EEPROM Vendor Unique Page "Forced Density" Example — Data Format

NOTE

In line 15 above, the number is given in ASCII code.

*MODE SELECT Command (6) / (10) (15h) / (55h) (continued)***5.9.10. Changeable Parameters within MODE SELECT**

The table below lists the MODE SELECT command's changeable parameters and their default, minimum, and maximum values. Descriptions of the various parameters are provided in the discussions of the different mode pages within MODE SELECT. Note that parameter rounding is supported for all parameters except for the block descriptor length.

Page: Parameter	Default	Minimum	Maximum
Header: Buffered Mode, Device Specific Byte	1	0	1
Header: Speed, Device Specific Byte	0	0	3
Block Descriptor Length	08h	00h	08h
Block Descriptor: Block Length			
10.0 GB and 20.0 GB Mode	0	0	FFFFFFEh
20.0 GB and 40.0 GB Mode	0	0	FFFFFFEh
35.0 GB and 70.0 GB Mode	0	0	FFFFFFEh
40.0 GB and 80.0 GB Mode	0	0	FFFFFFEh
READ / WRITE Error Recovery (01h): PER bit	0	0	1
Control Mode (0Ah): RLEC	0	0	1
Data Compression (0Fh): DCE	1	0	1
Disconnect / Reconnect (02h): Maximum Burst Size	0080h	0000h	FFFFh
Disconnect / Reconnect (02h): DTDC	0	0	3
Device Configuration (10h): WRITE Delay Time	C8h	Fh	1964h
Device Configuration (10h): SEW	1	0	1
Device Configuration (10h): Select Data Compression Algorithm	1	0	1

Table 5–48 Changeable Mode Parameters within MODE SELECT

5.10. MODE SENSE (6) / (10) Command (1Ah / 5Ah)

The MODE SENSE command allows the drive to report its media type, and current, or changeable configuration parameters to the host. It is a complementary command to MODE SELECT.

The command descriptor block for the 6-byte MODE SENSE (1Ah) is shown below. An illustration of the command descriptor block for the 10-byte MODE SENSE (5Ah) follows on the next page.

Bit Byte	7	6	5	4	3	2	1	0
0	Operation Code (1Ah)							
1	Logical Unit Number			Rsv'd	DBD	Reserved		
2	PC		Page Code					
3	Reserved							
4	Allocation Length							
5	Unused		Reserved			Flag	Link	

Figure 5–51 MODE SENSE (6) Command Descriptor Block — Data Format

The 10-byte MODE SENSE command is required to request the Vendor-Unique EEPROM parameter page due to the large amount of data that parameter page contains. MODE SENSE (10) can be used to retrieve the other pages as well. Note that MODE SENSE (10) returns descriptor data in a different format than MODE SENSE (6).

MODE SENSE (6) / (10) Command (1Ah / 5Ah) (continued)

Bit	7	6	5	4	3	2	1	0
Byte								
0	Operation Code (5Ah)							
1	Logical Unit Number			Rsv'd	DBD	Reserved		
2	PC		Page Code					
3	Reserved							
4	Reserved							
5	Reserved							
6	Reserved							
7 - 8	(MSB) Allocation Length (LSB)							
9	Unused		Reserved			Flag		Link

Figure 5-52 MODE SENSE (10) Command Descriptor Block — Data Format

MODE SENSE (6) / (10) Command (1Ah / 5Ah) (continued)

Field Name	Description										
DBD	Disable Block Descriptors. If 0, device returns the block descriptor data. If set to 1, block descriptor information is not returned.										
PC	Page Control. The Page Control field indicates the type of page parameter values to be returned to the host. <table border="1"> <thead> <tr> <th>PC</th> <th>Description</th> </tr> </thead> <tbody> <tr> <td>00</td> <td>Report Current Values</td> </tr> <tr> <td>01</td> <td>Report Changeable Values</td> </tr> <tr> <td>10</td> <td>Report Default Values</td> </tr> <tr> <td>11</td> <td>Report Saved Values</td> </tr> </tbody> </table>	PC	Description	00	Report Current Values	01	Report Changeable Values	10	Report Default Values	11	Report Saved Values
PC	Description										
00	Report Current Values										
01	Report Changeable Values										
10	Report Default Values										
11	Report Saved Values										
Page Code	This field allows the host to select any specific page or all of the pages supported by the drive.										
Allocation Length	This field specifies the number of bytes that the host has allocated for returned MODE SENSE data. An allocation length of zero indicates that the drive will return no MODE SENSE data. This is not considered an error, and GOOD status is returned.										

Table 5–49 MODE SENSE Control Descriptor Block — Field Descriptions

MODE SENSE may be either MODE SENSE (6) or MODE SENSE (10). MODE SENSE (6) data contains a 4-byte header followed by one 8-byte block descriptor, followed by zero or more variable length pages, depending on the Page Code and Allocation Length.

*MODE SENSE (6) / (10) Command (1Ah / 5Ah) (continued)***5.10.1. MODE SENSE Data Headers**

The MODE SENSE (6) and MODE SENSE (10) headers are illustrated below.

Bit	7	6	5	4	3	2	1	0
Byte								
0	Mode Sense Data Length							
1	Media Type							
2	WP	Buffered Mode			Speed			
3	Block Descriptor Length (08h)							

Figure 5–53 MODE SENSE (6) Data Header — Data Format

MODE SENSE (6) / (10) Command (1Ah / 5Ah) (continued)

Bit	7	6	5	4	3	2	1	0
Byte								
0 - 1	(MSB) Mode Sense Data Length (LSB)							
2	Media Type							
3	WP	Buffered Mode			Speed			
4	Reserved							
5	Reserved							
6 - 7	(MSB) Block Descriptor Length (08h) (LSB)							

Figure 5–54 MODE SENSE (10) Data Header — Data Format

MODE SENSE (6) / (10) Command (1Ah / 5Ah) (continued)

Field Name	Description												
Mode Sense Data Length	This field specifies the length (in bytes) of the MODE SENSE data that follows that is available to be transferred during the DATA IN phase. Note that the Mode Sense Data Length does not include itself.												
Media Type	The media type is determined by the drive and can be one of the following: <table border="1"> <thead> <tr> <th>Media Type</th> <th>Description</th> </tr> </thead> <tbody> <tr> <td>00h</td> <td>Unknown or not present</td> </tr> <tr> <td>81h</td> <td>Cleaning tape</td> </tr> <tr> <td>83h</td> <td>DLTtape III</td> </tr> <tr> <td>84h</td> <td>DLTtape IIIXT</td> </tr> <tr> <td>85h</td> <td>DLTtape IV</td> </tr> </tbody> </table>	Media Type	Description	00h	Unknown or not present	81h	Cleaning tape	83h	DLTtape III	84h	DLTtape IIIXT	85h	DLTtape IV
Media Type	Description												
00h	Unknown or not present												
81h	Cleaning tape												
83h	DLTtape III												
84h	DLTtape IIIXT												
85h	DLTtape IV												
WP	Write Protect. If 0, this field indicates that the tape is write-enabled. If set to 1, it indicates that the tape is write-protected.												
Buffered Mode	This implements Immediate Reporting on WRITE commands via the Buffered Mode. If the field is 0, then the drive does not report a GOOD status on WRITE commands until the data blocks are actually written to tape. If the field is 1, then the drive reports GOOD status on WRITE commands as soon as the data block has been transferred to the buffer. This is the default configuration of the drive. Note that if Buffered Mode is not used, the tape drive will suffer a degradation in performance, but not in capacity.												
Speed	The default setting = 0. Tape system will attempt to match the drive's throughput with the host data throughput. Other available settings are: 1 = Bus Speed Below 5.0 MB/sec 2 = Bus Speed 5.0 – 6.0 MB/sec 3 = Bus Speed of 6.0 MB/sec or more NOTE: This applies to DLT8000 format only.												
Block Descriptor Length	This field specifies the length (in bytes) of all of the block descriptors. Since the drive only supports one block descriptor, this value is 08h.												

Table 5–50 MODE SENSE Data Header — Field Descriptions

*MODE SENSE (6) / (10) Command (1Ah / 5Ah) (continued)***5.10.2. MODE SENSE Block Descriptor**

The illustration below describes the MODE SENSE block descriptor that follows the MODE SENSE header.

Bit	7	6	5	4	3	2	1	0
Byte								
0	Density Code							
1 - 3	(MSB)	Number of Blocks (000000h)						(LSB)
4	Reserved							
5 - 7	(MSB)	Block Length						(LSB)

Figure 5–55 MODE SENSE Block Descriptor — Data Format

Descriptions of the MODE SENSE blocks are provided in the table on the following page.

MODE SENSE (6) / (10) Command (1Ah / 5Ah) (continued)

Field Name	Description
Density Code	This field should match the current tape medium density; it is set to 0 if the density is unknown.
	Density
	Code Description
00h	Use default density
19h	62500 bpi, 64 track pairs, serial cartridge tape – 10.0 GB (DLTtape III) / 15.0 GB (DLTtape IIIXT)
1Ah	81633 bpi, 64 track pairs, serial cartridge tape – 20.0 GB (DLTtape IV)
1Bh	85937 bpi, 52 track quads, serial cartridge tape – 35.0 GB (DLTtape IV)
41h	98250 bpi, 52 track quads, serial cartridge tape – 40.0 GB (DLTtape IV)
	The density codes above are the preferred codes used to define density. Additionally, the codes listed below may be used, though use of the Data Compression Page is preferred:
	7Fh No change from previous density (No Operation)
80h	62500 bpi, 64 track pairs, serial cart.tape - 10.0 GB (DLTtape III) / 15.0 GB (DLTtape IIIXT) without compression
81h	62500 bpi, 64 track pairs, serial cart.tape - 20.0 GB (DLTtape III) / 30.0 GB (DLTtape IIIXT) with compression
82h	81633 bpi, 64 track pairs, serial cart.tape - 20.0 GB (DLTtape IV) without compression
83h	81633 bpi, 64 track pairs, serial cart.tape - 40 GB (DLTtape IV) with compression
84h	85937 bpi, 52 track quads, serial cartridge tape - 35GB (DLTtape IV) without compression
85h	85937 bpi, 52 track quads, serial cartridge tape - 70GB (DLTtape IV) with compression
88h	98250 bpi, 52 track quads, serial cartridge tape - 40GB (DLTtape IV) without compression
89h	98250 bpi, 52 track quads, serial cartridge tape - 80GB (DLTtape IV) with compression

*(continued)**Table 5–51 MODE SENSE Block Descriptor — Field Descriptions*

MODE SENSE (6) / (10) Command (1Ah / 5Ah) (continued)

Field Name	Description
Number of Blocks	This field is sent as 0, indicating that all of the remaining logical blocks on the tape have the medium characteristics specified by the block descriptor.
Block Length	This field specifies the length (in bytes) of each logical block transferred over the SCSI bus. A block length of 0 indicates that the length is variable (as specified in the I/O command). Any other value indicates the number of bytes per block that are used for READ, WRITE, and VERIFY type commands that specify a fixed bit of 1 (fixed block mode).

Table 5-50 MODE SENSE Block Descriptor — Field Descriptions (continued)

*MODE SENSE (6) / (10) Command (1Ah / 5Ah) (continued)***5.10.3. MODE SENSE Mode Pages**

The illustration below depicts the variable length page descriptor.

Bit	7	6	5	4	3	2	1	0
Byte								
0	PS	0	Page Code					
1	Additional Page Length							
2	Page Defined or Vendor-Unique Parameter Bytes							

Figure 5–56 MODE SENSE Page Descriptor — Data Format

Descriptions of the MODE SENSE page descriptor fields are provided in the table below. Detailed descriptions of each of the MODE SENSE Pages follow.

Field Name	Description
PS	Parameters Savable. When 0, the supported parameters cannot be saved (savable pages are not supported). When set to 1, it indicates that the page can be saved in nonvolatile memory by the drive.
Additional Page Length	This field indicates the number of bytes in the page. Note that this value does not include bytes 0 and 1. The length is returned on MODE SENSE and must subsequently be set to the same value when performing MODE SELECT.

Table 5–52 MODE SENSE Page Descriptor — Field Descriptions

MODE SENSE (6) / (10) Command (1Ah / 5Ah) (continued)

Page codes and pages that are supported are:

Page Code	Description	SENSE / SELECT	Section
00h	No Requested Page	SENSE	---
01h	READ / WRITE Error Recovery Page	BOTH	5.10.3.1
02h	Disconnect / Reconnect Page	BOTH	5.10.3.2
0Ah	Control Mode Page	BOTH	5.10.3.3
0Fh	Data Compression Page	BOTH	5.10.3.4
10h	Device Configuration Page	BOTH	5.10.3.5
11h	Medium Partition Page	BOTH	5.10.3.6
1Ch	TapeAlert Page	BOTH	5.10.3.7
3Eh	EEPROM Vendor Unique Page	BOTH	5.10.3.8
3Fh	All Pages (Except EEPROM)	BOTH	---

*MODE SENSE (6) / (10) Command (1Ah / 5Ah) (continued)***5.10.3.1. READ / WRITE Error Recovery Page (01h)**

The tape drive supports the Error Recovery Page for READ and WRITE operations. The format for the page is illustrated below.

Bit	7	6	5	4	3	2	1	0
Byte								
0	PS (0)	0	Page Code (01h)					
1	Additional Page Length (0Ah)							
2	Rsv'd	Rsv'd	TB	Rsv'd	EER	PER	DTE (0)	DCR (0)
3	READ Retry Count							
4 - 7	Reserved							
8	WRITE Retry Count							
9 - 11	Reserved							

Figure 5–57 READ / WRITE Error Recovery Page — Data Format

MODE SENSE (6) / (10) Command (1Ah / 5Ah) (continued)

Field Name	Description
PS	Parameters Savable. Must be 0, the supported parameters cannot be saved (savable pages are not supported).
Additional Page Length	This field indicates the number of bytes in the page. Note that this value does not include bytes 0 and 1. The length is returned on MODE SENSE and must subsequently be set to the same value when performing MODE SELECT.
TB	Transfer Block. The Transfer Block (when not fully recovered) function is not supported.
EER	Enable Early Recovery. This function is always enabled (must be = 1).
PER	Parity Error. This bit enables reporting of CHECK CONDITION for recovered READ / WRITE errors. Default is 0.
DTE	Disable Transfer on Error. Set to 0. This feature is not supported.
DCR	Disable ECC Correction Bit. Set to 0. This feature is not supported.
READ Retry Count	This field reports the maximum number of re-reads that are attempted before declaring an unrecoverable error.
WRITE Retry Count	This field reports the maximum number or overwrite retries that are attempted before declaring an unrecoverable error.

Table 5–53 READ / WRITE Error Recovery Page — Field Descriptions

*MODE SENSE (6) / (10) Command (1Ah / 5Ah) (continued)***5.10.3.2. DISCONNECT / RECONNECT Page (02h)**

The tape drive supports the DISCONNECT / RECONNECT Page. The format for the page is illustrated below.

Bit Byte	7	6	5	4	3	2	1	0
0	PS	0	Page Code (02h)					
1	Additional Page Length (0Eh)							
2	Buffer Full Ratio (0)							
3	Buffer Empty Ratio (0)							
4 - 5	(MSB)	Bus Inactivity Limit (0)						(LSB)
6 - 7	(MSB)	Disconnect Time Limit (0)						(LSB)
8 - 9	(MSB)	Connect Time Limit (0)						(LSB)
10 - 11	(MSB)	Maximum Burst Size						(LSB)
12	Reserved						DTDC	
13	Reserved							
14	Reserved							
15	Reserved							

Figure 5–58 Disconnect / Reconnect Page — Data Format

MODE SENSE (6) / (10) Command (1Ah / 5Ah) (continued)

Field Name	Description
PS	Parameters Savable. When 0, the supported parameters cannot be saved (savable pages are not supported). When set to 1, it indicates that the page can be saved in nonvolatile memory by the drive.
Additional Page Length	This field indicates the number of bytes in the page. Note that this value does not include bytes 0 and 1. The length is returned on MODE SENSE and must subsequently be set to the same value when performing MODE SELECT.
Buffer Full Ratio	Not supported.
Buffer Empty Ratio	Not supported.
Bus Inactivity Limit	Not supported.
Disconnect Time Limit	Not supported.
Connect Time Limit	Not supported.
Maximum Burst Size	The value in this field specifies the maximum amount of data to be transferred without disconnecting. A value of 0 sets no limit. This value is given in 512 byte increments. For example, a value of 8 indicates 4K bytes. Values that are not multiples of 8 are rounded up to the nearest multiple of 8.
DTDC	Data Transfer Disconnect Control. The value in this field specifies the restriction when a disconnect is permitted.

Table 5-54 DISCONNECT / RECONNECT Error Recovery Page — Field Descriptions

*MODE SENSE (6) / (10) Command (1Ah / 5Ah) (continued)***5.10.3.3. Control Mode Page (0Ah)**

The Control Mode Page allows the user to determine whether the tape drive returns a CHECK CONDITION status when one of the WRITE and READ counters has reached a specified threshold.

Bit	7	6	5	4	3	2	1	0
Byte								
0	Reserved		Page Code (0Ah)					
1	Page Length (06)							
2	Reserved							RLEC
3	Queue Algorithm Modifier (0)				Reserved		Qerr (0)	DQue (0)
4	EECA (0)	Reserved				RAENP (0)	UAAENP (0)	EAENP
5	Reserved							
6 - 7	(MSB)	Ready AEN Holdoff Period (0)						(LSB)

Figure 5–59 Control Mode Page — Data Format

MODE SENSE (6) / (10) Command (1Ah / 5Ah) (continued)

Field Name	Description
Page Length	The value in this field indicates the number of bytes in the Control Mode Page being transferred. The value for this byte is 06h.
RLEC	Report Log Exception Condition. This bit indicates whether the tape drive returns CHECK CONDITION status with sense key set to UNIT ATTENTION (06h) when one of its WRITE and READ error counters reaches a specified threshold, as follows: <ul style="list-style-type: none"> 0 Do not return UNIT ATTENTION when a threshold has been met. 1 Return UNIT ATTENTION when a threshold is met.
Queue Algorithm Modifier	Must be 0.
Qerr	Queue Error. Must be 0.
Dque	Disable Queuing. Must be 0.
EECA	Enable Extended Contingent Allegiance. Not supported; must be 0.
RAENP	Ready AEN Permission. Asynchronous event notification is not supported; must be 0.
UAAENP	Unit Attention AEN Permission. Not supported; must be 0.
EAENP	Enable AEN Permission. Asynchronous event notification is not supported; must be 0.
Ready AEN Holdoff Period	Not supported. Must be 0.

Table 5–55 Control Mode Page — Field Descriptions

*MODE SENSE (6) / (10) Command (1Ah / 5Ah) (continued)***5.10.3.4. Data Compression Page (0Fh)**

The Data Compression page specifies parameters for the control of data compression.

Bit	7	6	5	4	3	2	1	0
Byte								
0	PS (0)	Rsv'd	Page Code (0Fh)					
1	Page Length (0E)							
2	DCE	DCC	Reserved					
3	DDE (0)	RED (0)		Reserved				
4 - 7	(MSB) Compression Algorithm (LSB)							
8 - 11	(MSB) Decompression Algorithm (LSB)							
12 - 15	(MSB) Reserved (LSB)							

Figure 5–60 Data Compression Page — Data Format

MODE SENSE (6) / (10) Command (1Ah / 5Ah) (continued)

Field Name	Description						
PS	Parameters Savable. Not supported; must be 0.						
Page Length	The value in this field indicates the number of bytes in the Control Mode Page being transferred. The value for this byte is 0Eh.						
DCE	Data Compression Enable. The value returned for this bit depends on the current WRITE density of the tape drive: <table border="1"> <thead> <tr> <th>Value</th> <th>Write Compression is.....</th> </tr> </thead> <tbody> <tr> <td>0</td> <td>Disabled</td> </tr> <tr> <td>1</td> <td>Enabled</td> </tr> </tbody> </table>	Value	Write Compression is.....	0	Disabled	1	Enabled
Value	Write Compression is.....						
0	Disabled						
1	Enabled						
DCC	Data Compression Capable. The value returned for this bit indicates whether this tape drive supports data compression <table border="1"> <thead> <tr> <th>Value</th> <th>Data Compression is.....</th> </tr> </thead> <tbody> <tr> <td>0</td> <td>Disabled</td> </tr> <tr> <td>1</td> <td>Enabled</td> </tr> </tbody> </table>	Value	Data Compression is.....	0	Disabled	1	Enabled
Value	Data Compression is.....						
0	Disabled						
1	Enabled						
DDE	Data Decompression Enable. The value returned for this bit indicates whether data decompression is enabled or not. <table border="1"> <thead> <tr> <th>Value</th> <th>Data Decompression is.....</th> </tr> </thead> <tbody> <tr> <td>0</td> <td>Disabled</td> </tr> <tr> <td>1</td> <td>Enabled</td> </tr> </tbody> </table>	Value	Data Decompression is.....	0	Disabled	1	Enabled
Value	Data Decompression is.....						
0	Disabled						
1	Enabled						
RED	Note that when the tape drive reads compressed data from tape, it automatically decompresses the data before sending it to the initiator. The value for this bit, therefore, is always 1. Report Exception on Decompression. The tape drive does not report exceptions on decompression (boundaries between compressed and decompressed data). The value returned for RED is 00h.						
Compression Algorithm	The value for this field is 10h. This indicates the Lempel-Ziv high efficiency data compression algorithm.						
Decompression Algorithm	The value for this field is 10h. This indicates the Lempel-Ziv high efficiency data decompression algorithm. If EEPROM parameter EnaRepDCcomp is set, a value of 0 is reported if the last block read is not decompressed.						

Table 5-56 Data Compression Page — Field Descriptions

5.10.3.5. Device Configuration Page (10h)

The tape drive supports the Device Configuration Page. The format for the page is illustrated below.

Bit Byte	7	6	5	4	3	2	1	0
0	PS (0)	0	Page Code (10h)					
1	Additional Page Length (0Eh)							
2	Rsv'd	CAP (0)	CAF (0)	Active Format (0)				
3	Active Partition (0)							
4	WRITE Buffer Full Ratio (0)							
5	READ Buffer Empty Ratio (0)							
6 - 7	(MSB) WRITE Delay Time (LSB)							
8	DBR (0)	BIS (0)	RSmk	AVC (0)	SOCF (0)		RBO (0)	REW (0)
9	Gap Size (0)							
10	EOD Defined (0)			EEG (1)	SEW (1)	Reserved		
11 - 13	(MSB) Buffer Size at Early Warning (0) (LSB)							
14	Select Data Compression Algorithm							
15	Reserved							

Figure 5-61 Device Configuration Page — Data Format

MODE SENSE (6) / (10) Command (1Ah / 5Ah) (continued)

Field Name	Description
PS	Parameters Savable. Not supported; must be 0.
Additional Page Length	This field indicates the number of bytes in the page. Note that this value does not include bytes 0 and 1. The length is returned on MODE SENSE and must subsequently be set to the same value when performing MODE SELECT.
CAP	Change Active Partition. Not supported.
CAF	Change Active Format. Not supported.
Active Format	Not supported.
Active Partition	This field indicates the current logical partition number in use. Only partition 0 is supported.
WRITE Buffer Full Ratio	Indicates how full the buffer should be before restarting writing to the medium. The tape drive sets this to 0 (unused) since it uses an automatic adaptive mechanism to dynamically adjust its ratio according to the average data rates over the SCSI bus.
READ Buffer Empty Ratio	Indicates how empty the buffer should be before restarting reading from the medium. The tape drive sets this to 0 (unused) since it uses an automatic adaptive mechanism to dynamically adjust its ratio according to the average data rates over the SCSI bus.
WRITE Delay Time	Indicates the maximum time (in 100 ms increments) the drive waits with a partially fully buffer before forcing the data to tape. Note that the buffer full/empty ratio, which is dynamic, can cause data to be written sooner than the WRITE delay time value indicates. The WRITE delay time defaults to 200 ms (C8h). This causes the buffer to be flushed in 20 seconds. Minimum value is 15 (Fh); maximum value is 6500 (1964h). This represents a range in delay from 1.5 seconds to 11 minutes.
DBR	Data Buffer Recovery. Not supported, must be 0.
BIS	Block Identifiers Supported. Set to 1.
RSmk	Report Setmarks. Not supported, must be 0.
AVC	Automatic Velocity Control. Set to 0.
SOCF	Stop on Consecutive Filemarks. Set to 0.
RBO	Recover Buffer Order. Set to 0.
REW	Report Early Warning. Set to 0 (do not report early warning EOM on reads).

Table 5–57 Device Configuration Page — Field Descriptions

MODE SENSE (6) / (10) Command (1Ah / 5Ah) (continued)

Field Name	Description
Gap Size	Not supported. Set to 0.
EOD Defined	End of Data. Set to 00h.
EEG	Enable EOD Generation Bit. Set to 1 to indicate that the drive generates an EOD. The drive generates an EOD mark before any change of direction following a WRITE-type operation.
SEW	Synchronize at Early Warning. Set to 1.
Buffer Size at Early Warning	Not supported; must be 0.
Select Data Compression Algorithm	If set to 1, data compression is enabled. If 0, data compression is disabled.

Table 5–57 Device Configuration Page — Field Descriptions (continued)

*MODE SENSE (6) / (10) Command (1Ah / 5Ah) (continued)***5.10.3.6. Medium Partition Page (11h)**

The tape drive supports the Medium Partition Page. The format for the page is illustrated below.

Bit Byte	7	6	5	4	3	2	1	0
0	PS (0)	0	Page Code (11h)					
1	Additional Page Length (06h)							
2	Maximum Additional Partitions (0)							
3	Additional Partitions Defined (0)							
4	FDP (0)	SDP (0)	IDP (0)	PSUM (0)		Reserved		
5	Medium Format Recognition (01h)							
6	Reserved							
7	Reserved							

Figure 5–62 Medium Partition Page — Data Format

MODE SENSE (6) / (10) Command (1Ah / 5Ah) (continued)

Field Name	Description
PS	Parameters Savable. Not supported; must be 0.
Additional Page Length	This field indicates the number of bytes in the page. Note that this value does not include bytes 0 and 1. The length is returned on MODE SENSE and must subsequently be set to the same value when performing MODE SELECT.
Maximum Additional Partitions	Not supported. Must be 0.
Additional Partitions Defined	This field specifies the number of additional partitions to be defined for the tape based on the settings of the SDP and IDP bits. The maximum allowed is the value returned in the Maximum Additional Partitions field. Since only one partition is supported, this field must be 0.
FDP	Fixed Data Partitions. Must be 0.
SDP	Select Data Partitions. Must be 0.
IDP	Initiator Defined Patrons. Must be 0.
PSUM	Partition Size Unit of Measure. Must be 0.
Medium Format Recognition	Set to 01h, indicating that automatic format recognition is supported.

Table 5-58 Medium Partition Page — Field Descriptions

*MODE SENSE (6) / (10) Command (1Ah / 5Ah) (continued)***5.10.3.7. TAPEALERT PAGE (1Ch)**

The TapeAlert configuration settings can be read via the MODE SENSE command's TapeAlert Page.

Bit	7	6	5	4	3	2	1	0
Byte								
0	PS (0)	0	Page Code (1Ch)					
1	Additional Page Length (0A)							
2	Perf	Reserved			DExcpt	Test	Rsvd	LogErr
3	Reserved				MRIE			
4 – 7	(MSB) Interval Timer							(LSB)
8 – 11	(MSB) Report Count / Test Flag Number							(LSB)

Figure 5–63 TapeAlert Page Format Descriptor — Data Format

MODE SENSE (6) / (10) Command (1Ah / 5Ah) (continued)

Field Name	Description
PS	Parameters Savable. For MODE SELECT, this bit must be 0.
Additional Page Length	<p>This field indicates the number bytes in the page. However, the value does not include bytes 0 and 1. The length is returned in MODE SENSE commands and must subsequently be set to the same value when performing MODE SELECT. If the page length does not match that expected by the drive, a CHECK CONDITION status is returned, sense key set to ILLEGAL REQUEST.</p> <p>The drive returns a CHECK CONDITION status with sense key set to ILLEGAL REQUEST if it receives an unsupported Page Code or a Page field with values not supported or changeable. In such cases, no parameters are changed as a result of the command.</p>
Perf	Performance bit. Not supported.
DExcpt	Disable Information Exception Operations. When this bit = 0, the reporting method specified by the contents of MRIE is selected. When this bit = 1, all information exception operations are disabled and the contents of the MRIE field are ignored. When in this mode, the TapeAlert Log page is polled by the software. To enable CHECK CONDITION mode, DExcpt should = 0.

*(continued)**Table 5–59 TapeAlert Page Format Descriptor — Field Descriptions*

MODE SENSE (6) / (10) Command (1Ah / 5Ah) (continued)

Field Name	Description								
Test	Not Supported.								
LogErr	Error Log. Not Supported								
MRIE	<p>Method for Reporting Informational Exceptions. The tape drive uses the contents of this field to report information about exception conditions. Three methods are available:</p> <table border="1"> <thead> <tr> <th><u>Value</u></th> <th><u>Method</u></th> </tr> </thead> <tbody> <tr> <td>00h</td> <td>No reporting of Informational Exception Conditions. The device server does not report information exception conditions.</td> </tr> <tr> <td>03h</td> <td>Conditionally Generate Recovered Error. The device server reports informational exception conditions, if such reports of recovered errors is allowed, by returning CHECK CONDITION status on the next SCSI command (except INQUIRY and REQUEST SENSE commands) following detection of the condition. The Sense Key is set to RECOVERED ERROR with an additional sense code of 5D 00 (TapeAlert Event). The SCSI command with CHECK CONDITION completes without error prior to the report of any exception condition, and does not need to be repeated.</td> </tr> <tr> <td>06h</td> <td>Only Report Informational Exception Condition on Request. The device server preserves information exception data. To access the data, a poll can be taken by issuing an unsolicited REQUEST SENSE command. The Sense Key is set to NO SENSE with an additional sense code of 5D 00 (TapeAlert Event).</td> </tr> </tbody> </table> <p>The additional sense code of 5D 00 for values 03h and 06h signals that a TapeAlert has occurred. Information about the event is stored in the TapeAlert Log Page. The setting of MRIE does not impact logging of events in the TapeAlert Log Page.</p>	<u>Value</u>	<u>Method</u>	00h	No reporting of Informational Exception Conditions. The device server does not report information exception conditions.	03h	Conditionally Generate Recovered Error. The device server reports informational exception conditions, if such reports of recovered errors is allowed, by returning CHECK CONDITION status on the next SCSI command (except INQUIRY and REQUEST SENSE commands) following detection of the condition. The Sense Key is set to RECOVERED ERROR with an additional sense code of 5D 00 (TapeAlert Event). The SCSI command with CHECK CONDITION completes without error prior to the report of any exception condition, and does not need to be repeated.	06h	Only Report Informational Exception Condition on Request. The device server preserves information exception data. To access the data, a poll can be taken by issuing an unsolicited REQUEST SENSE command. The Sense Key is set to NO SENSE with an additional sense code of 5D 00 (TapeAlert Event).
<u>Value</u>	<u>Method</u>								
00h	No reporting of Informational Exception Conditions. The device server does not report information exception conditions.								
03h	Conditionally Generate Recovered Error. The device server reports informational exception conditions, if such reports of recovered errors is allowed, by returning CHECK CONDITION status on the next SCSI command (except INQUIRY and REQUEST SENSE commands) following detection of the condition. The Sense Key is set to RECOVERED ERROR with an additional sense code of 5D 00 (TapeAlert Event). The SCSI command with CHECK CONDITION completes without error prior to the report of any exception condition, and does not need to be repeated.								
06h	Only Report Informational Exception Condition on Request. The device server preserves information exception data. To access the data, a poll can be taken by issuing an unsolicited REQUEST SENSE command. The Sense Key is set to NO SENSE with an additional sense code of 5D 00 (TapeAlert Event).								
Interval Timer	Not Supported.								
Report Count / Test Flag Number	Not Supported.								

Table 5–59 TapeAlert Page Format Descriptor — Field Descriptions (continued)

*MODE SENSE (6) / (10) Command (1Ah / 5Ah) (continued)***5.10.3.8. EEPROM Vendor Unique page (3Eh)**

The tape drive supports the EEPROM vendor unique page (3Eh). All the EEPROM parameters setable via the MODE SELECT's EEPROM Vendor Unique page are returned.

NOTE

Because of the length of the parameter list, use MODE SENSE (10) instead of MODE SENSE (6) to retrieve EEPROM parameters.

Because of the length of the list of EEPROM parameters, a 10-byte MODE SENSE command is required. If a 6-byte MODE SENSE command is used for retrieval, the data is returned as follows:

Send a 10-byte MODE SENSE command to get the Parameter List.

The data returned by the 10-byte MODE SENSE command for the EEPROM page is in the form of a MODE SENSE (10) data header followed by block and page descriptors.

The data in the page descriptor is organized in the form of a parameter header followed by the actual parameter's value. The parameter is as follows:

<u>Name T</u>	<u>Current</u>	<u>Default</u>	<u>Minimum</u>	<u>Maximum</u>
---------------	----------------	----------------	----------------	----------------

Name refers to the parameter name, for example, PRODUCTID or DEFAULTCOMPON.

T designates data type: “**b**” indicates binary, “**A**” indicates string type, and if there is no designator, the data is in decimal.

Current, Default, Minimum, and Maximum specify the current, default, minimum, and maximum values of the parameter.

5.11. PERSISTENT RESERVATION IN Command (5Eh)

The PERSISTENT RESERVATION IN command is a 10-byte command used to obtain information about persistent reservations and reservations that are active within a device server. It is used in conjunction with the PERSISTENT RESERVATION OUT command. Note that reservations are not persistent across power cycles.

The figure below illustrates the format of the PERSISTENT RESERVATION IN command; the table that follows explains the data fields of the command.

Bit Byte	7	6	5	4	3	2	1	0
0	Operation Code (5Eh)							
1	Reserved			Service Action				
2 - 6	Reserved							
7 - 8	(MSB) Allocation Length (LSB)							
9	Unused	Reserved				Flag	Link	

Figure 5-64 PERSISTENT RESERVATION IN Command Descriptor Block — Data Format

PERSISTENT RESERVATION IN Command (5Eh) (continued)

Data Field	Description												
Service Action	<p>Service actions that require information about persistent reservation and registrations may require enabling of nonvolatile memory within the logical unit.</p> <p>Service action codes available are:</p> <table border="1"> <thead> <tr> <th><u>Code</u></th> <th><u>Name</u></th> <th><u>Description</u></th> </tr> </thead> <tbody> <tr> <td>00h</td> <td>Read Keys</td> <td>Reads all registered Reservation keys</td> </tr> <tr> <td>01h</td> <td>Read Reservations</td> <td>Reads all current persistent reservations</td> </tr> <tr> <td>02 – 1Fh</td> <td>Reserved</td> <td>Reserved</td> </tr> </tbody> </table> <p>A “Read Keys” service action requests that the device server return a parameter list that includes a header and a complete list of all of the reservation keys currently registered with the device server. If multiple initiators have registered with the same key, then the key is listed multiple times, once for each registration. Refer to Figure 5-65 and Table 5-61 for information about Read Keys parameter data.</p> <p>A “Read Reservation” service action requests that the device server return a parameter list that contains a header and a complete list of all persistent reservations that are presently active in the device server and its extents. Note that duplicate persistent reservations from the same initiator are not reported. Refer to Figure 5-66 and Table 5-62 for information about Read Reservations parameter data.</p>	<u>Code</u>	<u>Name</u>	<u>Description</u>	00h	Read Keys	Reads all registered Reservation keys	01h	Read Reservations	Reads all current persistent reservations	02 – 1Fh	Reserved	Reserved
<u>Code</u>	<u>Name</u>	<u>Description</u>											
00h	Read Keys	Reads all registered Reservation keys											
01h	Read Reservations	Reads all current persistent reservations											
02 – 1Fh	Reserved	Reserved											
Allocation Length	<p>This field indicates how much space has been reserved for the returned parameter list (Read Keys or Read Reservations parameters). The actual length of the parameter data is indicated in the parameter data field for those parameters.</p> <p>If the Allocation Length is not sufficient to contain the entire list of parameters, the first portion of the list that does fit is returned. If it is determined that the remainder of the list is required, the client should send a new PERSISTENT RESERVATION IN command with an Allocation Length field large enough to contain the entire list of parameters.</p>												

Table 5–60 PERSISTENT RESERVATION IN Command — Field Descriptions

PERSISTENT RESERVATION IN Command (5Eh) (continued)

The figure and table below illustrate and describe the data fields of Read Key data parameters.

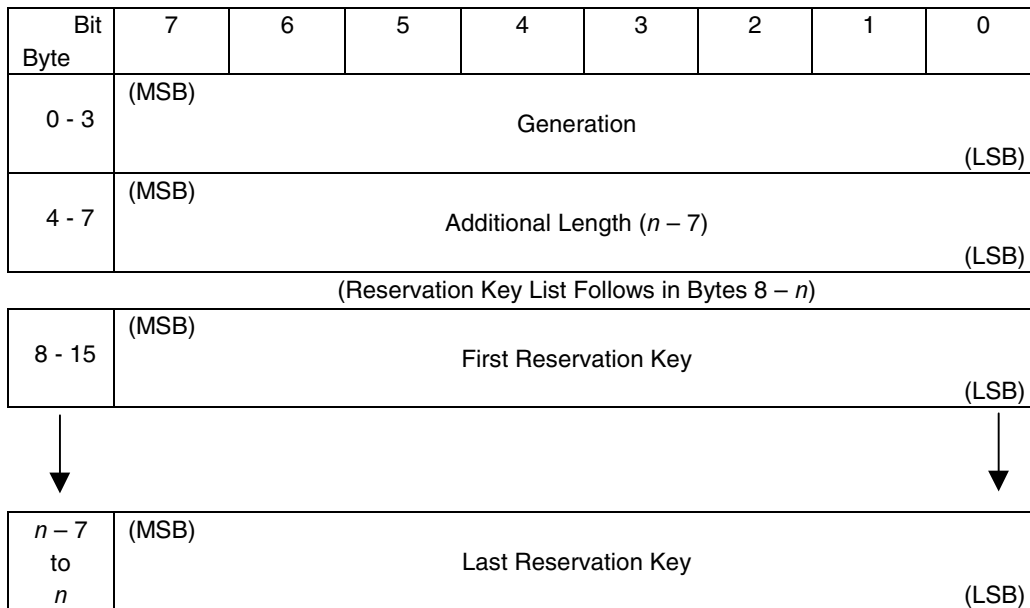

Figure 5–65 Read Keys Parameters — Data Format

PERSISTENT RESERVATION IN Command (5Eh) (continued)

Data Field	Description
Generation	<p>The value in this field is a 32-bit counter in the device server that is incremented each time a PERSISTENT RESERVATION OUT command requests a Register, Clear, Pre-empt, or Pre-empt and Clear operation. Note that PERSISTENT RESERVATION IN commands do not increment the counter, nor do PERSISTENT RESERVATION OUT commands that perform a Reserve or Release service action, or by a PERSISTENT RESERVATION OUT command that is not done due to an error or a reservation conflict. The value in the Generation field is set to 0 as part of the power on or reset processes.</p> <p>The value in the Generation field allows the application client that examines the value to verify that the configuration of the initiators attached to a logical unit has not been modified by another application client without any notification of the application client doing the examination.</p>
Additional Length	<p>This field contains the count of the number of bytes that are in the Reservation Key list (bytes 8 – <i>n</i>). Note that this field contains the number of bytes in the reservation key list regardless of the value prescribed by the Allocation Length field in the command's CDB.</p>
Reservation Keys	<p>Each of the Reservation Keys appear as items in a list as bytes 8 through <i>n</i>. Each entry reflects an 8-byte reservation key registered with the device server via the PERSISTENT RESERVATION OUT, Reserve, Pre-empt, Pre-empt and Clear, or Register service actions. Each key can be examined by the application client for correlation with a set of initiators and SCSI ports.</p>

Table 5–61 Read Keys Parameters — Field Descriptions

PERSISTENT RESERVATION IN Command (5Eh) (continued)

The figure and table below illustrate and describe the data fields of Read Reservations data parameters.

Bit Byte	7	6	5	4	3	2	1	0
0 - 3	(MSB) Generation (LSB)							
4 - 7	(MSB) Additional Length ($n - 7$) (LSB)							
8 - n	(MSB) Reservation Descriptors (See Figure 5-67 / Table 5-63 for detail of a Descriptor Field) (LSB)							

Figure 5–66 Read Reservations Parameters — Data Format

Data Field	Description
Generation	<p>The value in this field is a 32-bit counter in the device server that is incremented each time a PERSISTENT RESERVATION OUT command requests a Register, Clear, Pre-empt, or Pre-empt and Clear operation. Note that PERSISTENT RESERVATION IN commands do not increment the counter, nor do PERSISTENT RESERVATION OUT commands that perform a Reserve or Release service action, or by a PERSISTENT RESERVATION OUT command that is not done due to an error or a reservation conflict. The value in the Generation field is set to 0 as part of the power on or reset processes.</p> <p>The value in the Generation field allows the application client that examines the value to verify that the configuration of the initiators attached to a logical unit has not been modified by another application client without any notification of the application client doing the examination.</p>
Additional Length	This field contains the count of the number of bytes of Reservation descriptors (bytes 8 – n). Note that this field contains the number of bytes regardless of the value prescribed by the Allocation Length field in the command's CDB.
Reservations Descriptors	One Reservation descriptor is reported for each unique persistent reservation on the logical unit when the PERSISTENT RESERVATION IN command has indicated a Read Reservations action. Figure 5-67 and Table 5-63 detail the contents of each Reservation Descriptors field.

Table 5–62 Read Reservations Parameters — Field Descriptions

PERSISTENT RESERVATION IN Command (5Eh) (continued)

The figure and table below illustrate and describe the data fields of each Read Reservations descriptor's data fields.

Bit Byte	7	6	5	4	3	2	1	0
0 - 7	(MSB) Reservation Key (LSB)							
8 - 11	(MSB) Scope-Specific Address (LSB)							
12	Reserved							
13	Scope				Type			
14 - 15	(MSB) Extent Length (LSB)							

Figure 5–67 PERSISTENT RESERVATION IN Read Reservations Descriptor — Data Format

PERSISTENT RESERVATION IN Command (5Eh) (continued)

Data Field	Description																
Reservation Key	The Reservation key field contains an 8-byte value that identifies the reservation key under which the persistent reservation is held.																
Scope-Specific Address	<p>If the Scope field (Byte 13, bits 4 – 7) represents an “Extent” reservation, the Scope-Specific Address field contains the logical block address (LBA) of the first block of the extent and the Extent Length field (Bytes 14 – 15) contains the number of blocks in the extent.</p> <p>If the Scope field represents an “Element” reservation, the Scope-Specific Address field contains the Element address, zero-filled in the most significant bytes to fit the field and the Extent Length field is set to zero.</p>																
Scope	<p>The value in this field indicates whether a persistent reservation applies to an entire logical unit, to a part of the logical unit (defined as an extent), or to an element.</p> <p>The values for the Scope field are:</p> <table border="1"> <thead> <tr> <th>Code</th> <th>Name</th> <th>Description</th> </tr> </thead> <tbody> <tr> <td>0h</td> <td>LU</td> <td>Logical Unit. Persistent reservation applies to the full logical unit. The LU scope is therefore implemented by all device servers that implement PERSISTENT RESERVATION OUT.</td> </tr> <tr> <td>1h</td> <td>Extent</td> <td>Persistent reservation applies to the specified extent. When Extent is the scope, it indicates that the persistent reservation applies to the extent of the logical unit defined by the Scope-Specific Address and Extent Length fields in the PERSISTENT RESERVATION OUT command's parameter list. Note that an extent is defined only for devices defining contiguous logical block addresses. The Extent scope is optional for all device servers that implement PERSISTENT RESERVATION OUT.</td> </tr> <tr> <td>2h</td> <td>Element</td> <td>Persistent reservation applies to the specified element. When Element is the scope, it indicates that the persistent reservation applies to the element of the logical unit defined by the Scope-Specific Address field in the PERSISTENT RESERVATION OUT parameter list. An element is as defined by the SCSI-3 Medium Changer Commands (SMC) standard. The Element scope is optional for all device servers that implement PERSISTENT RESERVATION OUT.</td> </tr> <tr> <td>3h – Fh</td> <td>Reserved</td> <td>Reserved</td> </tr> </tbody> </table>		Code	Name	Description	0h	LU	Logical Unit. Persistent reservation applies to the full logical unit. The LU scope is therefore implemented by all device servers that implement PERSISTENT RESERVATION OUT.	1h	Extent	Persistent reservation applies to the specified extent. When Extent is the scope, it indicates that the persistent reservation applies to the extent of the logical unit defined by the Scope-Specific Address and Extent Length fields in the PERSISTENT RESERVATION OUT command's parameter list. Note that an extent is defined only for devices defining contiguous logical block addresses. The Extent scope is optional for all device servers that implement PERSISTENT RESERVATION OUT.	2h	Element	Persistent reservation applies to the specified element. When Element is the scope, it indicates that the persistent reservation applies to the element of the logical unit defined by the Scope-Specific Address field in the PERSISTENT RESERVATION OUT parameter list. An element is as defined by the SCSI-3 Medium Changer Commands (SMC) standard. The Element scope is optional for all device servers that implement PERSISTENT RESERVATION OUT.	3h – Fh	Reserved	Reserved
Code	Name	Description															
0h	LU	Logical Unit. Persistent reservation applies to the full logical unit. The LU scope is therefore implemented by all device servers that implement PERSISTENT RESERVATION OUT.															
1h	Extent	Persistent reservation applies to the specified extent. When Extent is the scope, it indicates that the persistent reservation applies to the extent of the logical unit defined by the Scope-Specific Address and Extent Length fields in the PERSISTENT RESERVATION OUT command's parameter list. Note that an extent is defined only for devices defining contiguous logical block addresses. The Extent scope is optional for all device servers that implement PERSISTENT RESERVATION OUT.															
2h	Element	Persistent reservation applies to the specified element. When Element is the scope, it indicates that the persistent reservation applies to the element of the logical unit defined by the Scope-Specific Address field in the PERSISTENT RESERVATION OUT parameter list. An element is as defined by the SCSI-3 Medium Changer Commands (SMC) standard. The Element scope is optional for all device servers that implement PERSISTENT RESERVATION OUT.															
3h – Fh	Reserved	Reserved															

(continued)

*Table 5–63 PERSISTENT RESERVATION IN Read Reservations
Descriptor — Field Descriptions*

PERSISTENT RESERVATION IN Command (5Eh) (continued)

Data Field	Description
Type	The value of the Type field specifies the characteristics of the persistent reservation being established for all data blocks within the extent or within the logical unit. Refer to Table 5-64 for the applicable Type codes and their meanings

*Table 5–63 PERSISTENT RESERVATION IN Read Reservations
Descriptor — Field Descriptions (continued)*

Table 5–64 presents the definitions of the characters of the available “Type” values from the Type field of the PERSISTENT RESERVATION IN Read Reservations parameters.

Each of the codes provides handling instructions for READ operations, for WRITE operations, and for subsequent attempts to establish persistent reservations (referred to as “Additional Reservations Allowed” in the table).

PERSISTENT RESERVATION IN Command (5Eh) (continued)

Code	Name	Description
0h	READ	<p>READS: Shared; any application client on any initiator may execute commands that perform transfers from the target to the initiator.</p> <p>WRITES: Prohibited; any command from any initiator that performs a transfer from the initiator to the target results in a reservation conflict.</p> <p>ADDITIONAL RESERVATIONS: Allowed; any initiator may reserve the logical unit, extents, or elements as long as the persistent reservations do not conflict with any reservations already known to the device server.</p>
1h	WRITE	<p>READS: Shared; any application client on any initiator may execute commands that perform transfers from the target to the initiator.</p> <p>WRITES: Exclusive; any command from any initiator other than the initiator that holds the persistent reservation that attempts a transfer to the target results in a reservation conflict</p> <p>ADDITIONAL RESERVATIONS: Allowed; any initiator may reserve the logical unit, extents, or elements as long as the persistent reservations do not conflict with any reservations already known to the device server.</p>
2h	READ	<p>READS: Exclusive; any command from any initiator other than the initiator that holds the persistent reservation that attempts a transfer from the target results in a reservation conflict</p> <p>WRITES: Shared; any application client on any initiator may execute commands that perform transfers to the target from the initiator.</p> <p>ADDITIONAL RESERVATIONS: Allowed; any initiator may reserve the logical unit, extents, or elements as long as the persistent reservations do not conflict with any reservations already known to the device server.</p>

*(continued)**Table 5-64 Persistent Reservation Type Codes and Their Meanings*

PERSISTENT RESERVATION IN Command (5Eh) (continued)

Code	Name	Description
3h		<p>Exclusive; any command from any initiator other than the initiator holding the persistent reservation that attempts a transfer from the target results in a reservation conflict.</p> <p>Exclusive; any command from any initiator other than the initiator holding the persistent reservation that attempts a transfer to the target results in a reservation conflict.</p> <p>Restricted; any PERSISTENT RESERVATION OUT command with the Reserve service action from any initiator other than the initiator holding the persistent reservation results in a reservation conflict. The initiator that holds the persistent reservation can reserve the logical unit, extents, or elements as long as the persistent reservations do not conflict with any reservations already known to the device server.</p>
4h		<p>Shared; any application client on any initiator may execute commands that perform transfers from the target to the initiator.</p> <p>Shared; any application client on any initiator may execute commands that perform transfers to the target from the initiator.</p> <p>Restricted; any PERSISTENT RESERVATION OUT command with the Reserve service action from any initiator other than the initiator holding the persistent reservation results in a reservation conflict. The initiator that holds the persistent reservation can reserve the logical unit, extents, or elements as long as the persistent reservations do not conflict with any reservations already known to the device server.</p>

*(continued)**Table 5-64 Persistent Reservation Type Codes and Their Meanings (continued)*

PERSISTENT RESERVATION IN Command (5Eh) (continued)

Code	Name	Description
5h	WRITE	<p>READS: Shared; any application client on any initiator may execute commands that perform transfers from the target to the initiator.</p> <p>WRITES: Exclusive; any command from an initiator that has not previously performed a Register service action with the device server that attempts a transfer to the target results in a reservation conflict</p> <p>ADDITIONAL RESERVATIONS: Allowed; any initiator may reserve the logical unit, extents, or elements as long as the persistent reservations to not conflict with any reservations already known to the device server.</p>
	Registrants Only	
6h	Exclusive	<p>READS: Exclusive; any command from an initiator that has not previously performed a Register service action with the device server that attempts a transfer from the target results in a reservation conflict.</p> <p>WRITES: Exclusive; any command from an initiator that has not previously performed a Register service action with the device server that attempts a transfer to the target results in a reservation conflict</p> <p>ADDITIONAL RESERVATIONS: Allowed; any initiator may reserve the logical unit, extents, or elements as long as the persistent reservations to not conflict with any reservations already known to the device server.</p>
	Registrants Only	
7h - Fh	Reserved	N/A

Table 5–64 Persistent Reservation Type Codes and Their Meanings (continued)

Table 5–65 represents graphically all possible combinations of Persistent Reservations Being Attempted when Persistent Reservations are already held for each of the types of persistent reservations.

PERSISTENT RESERVATION IN Command (5Eh) (continued)

Persistent Reservation Already Held														
Persistent Reservation Being Attempted	READ Shared		WRITE Exclusive		READ Exclusive		Exclusive Access *		Shared Access *		WRITE Exclusive RO		Exclusive Access RO	
	LU	EX	LU	EX	LU	EX	LU	EX	LU	EX	LU	EX	LU	EX
READ Shared LU	N	N	Y	Y	Y	Y	Y	Y	N	N	Y	Y	Y	Y
EX	N	N	Y	O	Y	O	Y	O	N	N	Y	O	Y	O
WRITE Exclusive LU	Y	Y	Y	Y	Y	Y	Y	Y	Y	Y	Y	Y	Y	Y
EX	Y	O	Y	O	Y	O	Y	O	Y	O	Y	O	Y	O
READ Exclusive LU	Y	Y	Y	Y	Y	Y	Y	Y	Y	Y	Y	Y	Y	Y
EX	Y	O	Y	O	Y	O	Y	O	Y	O	Y	O	Y	O
Exclusive Access * LU	Y	Y	Y	Y	Y	Y	Y	Y	Y	Y	Y	Y	Y	Y
EX	Y	O	Y	O	Y	O	Y	O	Y	O	Y	O	Y	O
Shared Access * LU	N	N	Y	Y	Y	Y	Y	Y	N	N	Y	Y	Y	Y
EX	N	N	Y	O	Y	O	Y	O	N	N	Y	O	Y	O
WRITE Exclusive RO LU	Y	Y	Y	Y	Y	Y	Y	Y	Y	Y	N	N	N	N
EX	Y	O	Y	O	Y	O	Y	O	O	O	N	N	N	N
Exclusive Access RO LU	Y	Y	Y	Y	Y	Y	Y	Y	Y	Y	N	N	N	N
EX	Y	O	Y	O	Y	O	Y	O	Y	O	N	N	N	N

KEY: LU = Logical Unit Scope
 EX = Extent or Element Scope
 RO = Registrants Only

N = No Conflict

Y = Conflict

O = Conflict occurs if extent or element overlaps with existing extent or element reservation.

* = Conflicts with all reservation requests from other

Table 5-65 When Do Conflicts Between Existing Reservations and New Reservations Exist?

5.12. PERSISTENT RESERVATION OUT Command (5Fh)

The PERSISTENT RESERVATION OUT command is a 10-byte command used to reserve a logical unit or an extent within a logical unit for the exclusive or shared use by an initiator. Note that reservations are not persistent across power cycles. The command is used in conjunction with the PERSISTENT RESERVATION IN command; it is not used with the RESERVE and RELEASE commands.

Persistent reservations conflict with reservations made via the RESERVE command. Initiators that perform PERSISTENT RESERVATION OUT actions are identified by a reservation key assigned by the application client. The client may use the PERSISTENT RESERVATION IN command to identify which other initiators within a system hold conflicting or invalid persistent reservations and use the PERSISTENT RESERVATION OUT command to preempt those reservations if necessary.

Note that since persistent reservations are not reset by the TARGET RESET task management function or other global actions, they can be used to enact device sharing among multiple initiators. The PERSISTENT RESERVATION OUT and PERSISTENT RESERVATION IN commands provide the means for resolving contentions in multiple-initiator systems with multiple port target. By using the reservation key to identify persistent reservations, it is possible to determine which ports hold conflicting persistent reservations and to take over such reservations from failing or “greedy” initiators.

The figure that follows illustrates the format of the PERSISTENT RESERVATION OUT command; the table that follows explains the data fields of the command.

PERSISTENT RESERVATION OUT Command (5Fh) (continued)

Bit Byte	7	6	5	4	3	2	1	0
0	Operation Code (5Fh)							
1	Reserved			Service Action				
2	Scope				Type			
3 - 6	Reserved							
7 - 8	Parameter List Length (18h)							(LSB)
9	Unused	Reserved				Flag	Link	

Figure 5-68 PERSISTENT RESERVATION OUT Command Descriptor Block — Data Format

PERSISTENT RESERVATION OUT Command (5Fh) (continued)

Data Field	Description	
Service Action	Service actions that require information about persistent reservation and registrations may require enabling of nonvolatile memory within the logical unit.	
	Service action codes available are:	
	Code	Name Description
	00h	Register Register a reservation key with the device server
	01h	Reserve Create a persistent reservation using a reservation key
	02h	Release Release a persistent reservation
	03h	Clear Clear all reservation keys and all persistent reservations
	04h	Pre-empt Pre-empt persistent reservations from another initiator
	05h	Pre-empt & Clear Pre-empt persistent reservations from another initiator and clear the task set for the pre-empted initiator
	06 – 1Fh	Reserved
	Refer to Table 5-67 for detailed descriptions of each of the service action codes.	

*(continued)**Table 5–66 PERSISTENT RESERVATION OUT Command — Field Descriptions*

PERSISTENT RESERVATION OUT Command (5Fh) (continued)

Data Field	Description	
Scope	The value in this field indicates whether a persistent reservation applies to an entire logical unit, to a part of the logical unit (defined as an extent), or to an element.	
	The values for the Scope field are:	
	<u>Code</u>	<u>Name</u> <u>Description</u>
	0h	LU Logical Unit. Persistent reservation applies to the full logical unit. The LU scope is therefore implemented by all device servers that implement PERSISTENT RESERVATION OUT.
	1h	Extent Persistent reservation applies to the specified extent. When Extent is the scope, it indicates that the persistent reservation applies to the extent of the logical unit defined by the Scope-Specific Address and Extent Length fields in the PERSISTENT RESERVATION OUT command's parameter list. Note that an extent is defined only for devices defining contiguous logical block addresses. The Extent scope is optional for all device servers that implement PERSISTENT RESERVATION OUT.
	2h	Element Persistent reservation applies to the specified element. When Element is the scope, it indicates that the persistent reservation applies to the element of the logical unit defined by the Scope-Specific Address field in the PERSISTENT RESERVATION OUT parameter list. An element is as defined by the SCSI-3 Medium Changer Commands (SMC) standard. The Element scope is optional for all device servers that implement PERSISTENT RESERVATION OUT.
	3h – Fh	Reserved Reserved

(continued)

*Table 5–66 PERSISTENT RESERVATION OUT Command —
Field Descriptions (continued)*

PERSISTENT RESERVATION OUT Command (5Fh) (continued)

Data Field	Description
Type	The value of the Type field specifies the characteristics of the persistent reservation being established for all data blocks within the extent or within the logical unit. Refer to Table 5–68 for the applicable Type codes and their meanings
Parameter List Length	Fields contained in the PERSISTENT RESERVATION OUT parameter list specify the reservation keys and extent information required to perform a persistent reservation service action. The parameter list is 24 bytes in length; the Parameter List Length field contains 24 (18h) bytes.

*Table 5–66 PERSISTENT RESERVATION OUT Command —
Field Descriptions (continued)*

Table 5–67 provides detailed descriptions of each of the PERSISTENT RESERVATION OUT command's seven possible service actions (Service Action codes appear in bits 0 – 4 of Byte 1).

PERSISTENT RESERVATION OUT Command (5Fh) (continued)

Code	Name	Description
00h	Register	<p>When the command executes a Register service action, it registers a reservation key with a device server without generating a reservation. The device server holds these reservation keys from each initiator that performs a PERSISTENT RESERVATION OUT command with a Register service action until the key is changed by a new PERSISTENT RESERVATION OUT command with Register service action from the same initiator, or until the initiator registration is removed by:</p> <ul style="list-style-type: none"> • Powering down the logical unit, if the last Activate Persist Through Power Loss (APTPL; see Figure 5-69 and Table 5-69) received by the device server was 0; • Performing a Clear service action; • Performing a Pre-empt service action; • Performing a Pre-empt and Clear service action; or • Performing a Register service action from the same initiator with the value of the service action reservation key set to 0. <p>When a reservation key has not yet been established or when the reservation key has been removed, a reservation key of 0 is used when the initiator performs a PERSISTENT RESERVATION OUT with the Register service action. When the reservation has been removed, no information is reported for the initiator in the Read Keys service action of the resulting PERSISTENT RESERVATION IN command..</p>
01h	Reserve	<p>A PERSISTENT RESERVATION OUT command with Reserve service action creates a persistent reservation with a specified Scope and Type.</p> <p>Persistent reservations are not superseded by a new persistent reservation from any initiator except by the execution of a PERSISTENT RESERVATION OUT command that specifies either a Pre-empt or Pre-empt and Clear service action. New persistent reservations that do not conflict with an existing persistent reservation execute normally. Persistent reservations of logical units or extents having the same Type value are permitted if no conflicting persistent reservations are held by another initiator. When these types of overlapping reservations are released, each of the extent reservations and logical unit reservations are removed with a separate Release service action. Multiple identical reservations from the same initiator are all released simultaneously via a single Release service action that matches the reservations.</p>

(continued)

Table 5–67 PERSISTENT RESERVATION OUT Command's Service Action Descriptions

PERSISTENT RESERVATION OUT Command (5Fh) (continued)

Code	Name	Description
02h	Release	<p>A PERSISTENT RESERVATION OUT command with Release service action removes a persistent reservation held by the same initiator.</p> <p>The fields associated with a Release service action match fields of the active persistent reservation. Sending of a PERSISTENT RESERVATION OUT command that specifies a Release service action when no persistent reservation exists from that initiator does not result in an error. Instead, the device server returns a GOOD message without altering any other reservation: the reservation key is not changed by the Release service action.</p> <p>The device server returns a CHECK CONDITION status for any PERSISTENT RESERVATION OUT command that specifies the release of a persistent reservation held by the requesting initiator that matches some but not all of the Scope, Type, Reservation Key, and extent values. The sense key is set to ILLEGAL REQUEST and additional sense data is set to INVALID RELEASE OF ACTIVE PERSISTENT RESERVATION. Attempts to release persistent reservations in which none of the Scope, Type, Reservation Key, and extent values match an existing persistent reservation held by the initiator making the request are not errors.</p> <p>An active persistent reservation may also be released by:</p> <ul style="list-style-type: none"> Powering off. When the most recent APTPL value received by the device server is 0, a power-off performs a hard reset, clears all persistent reservations, and removes all registered reservation keys; <p>or</p> <ul style="list-style-type: none"> Executing a PERSISTENT RESERVATION OUT command from another initiator with a persistent reserve service action of Pre-empt or Pre-empt and Clear. <p>Note that a Release service action should not be performed if any operations interlocked by the persistent reservation have not yet completed.</p>
03h	Clear	<p>A PERSISTENT RESERVATION OUT command with a successful Clear service action removes all persistent reservations for all initiators. All reservation keys are also removed. Any commands from any initiator that have been accepted by the device server as non-conflicting continue their normal executions.</p> <p>A UNIT ATTENTION condition is established for all initiators for the cleared logical unit. The sense key is set to UNIT ATTENTION; the additional sense data is set to RESERVATIONS PREEMPTED.</p> <p>Note that applications should not use the Clear action service except during recoveries associated with initiator or system reconfiguration, since data integrity may be compromised.</p>

(continued)

Table 5–67 PERSISTENT RESERVATION OUT Command's Service Action Descriptions (continued)

PERSISTENT RESERVATION OUT Command (5Fh) (continued)

Code	Name	Description
04h	Pre-empt	<p>A PERSISTENT RESERVATION OUT command with a successful Pre-empt service action removes all persistent reservations for all initiators that have been registered with the Service action Reservation key specified in the PERSISTENT RESERVATION OUT command's parameter list. A persistent reservation is also established for the pre-empting initiator. Any commands from any initiator that have been accepted by the device server as non-conflicting continue their normal executions. If a PERSISTENT RESERVATION OUT command is sent that specifies a Pre-empt service action and no persistent reservation exists for the initiator identified by the Service action Reservation key, it is not an error condition.</p> <p>A UNIT ATTENTION condition is established for the pre-empted initiators. The sense key is set to UNIT ATTENTION; the additional sense data is set to RESERVATIONS PREEMPTED. Commands that follow are subject to the persistent reservation restrictions set by the pre-empting initiator.</p> <p>The persistent reservation thus created by the pre-empting initiator is defined by the Scope and Type fields of the PERSISTENT RESERVATION OUT command and the corresponding fields of the command's parameter list.</p> <p>The registration keys for the pre-empted initiators are removed by the Pre-empt service action; the reservation key for an initiator that has performed a Pre-empt service action with its own Reservation key specified in the Service action Reservation key remains unchanged, although all other specified releasing actions and reservation actions are performed.</p> <p>Note that persistent reservations are not superseded by a new persistent reservation from any initiator except by the execution of a PERSISTENT RESERVATION OUT that specifies either the Pre-empt or the Pre-empt and Clear service actions. New persistent reservations that do not conflict with an existing persistent reservation execute normally. The persistent reservation of a logical unit or extents having the same Type value are permitted if no conflicting persistent reservations other than the reservations being pre-empted are held by another initiator.</p>

(continued)

Table 5–67 PERSISTENT RESERVATION OUT Command's Service Action Descriptions (continued)

PERSISTENT RESERVATION OUT Command (5Fh) (continued)

Code	Name	Description
05h	Pre-empt & Clear	<p>A PERSISTENT RESERVATION OUT command with a Pre-empt & Clear service action removes all persistent reservations for all initiators that have been registered with the Service action Reservation key specified in the PERSISTENT RESERVATION OUT command's parameter list. It also establishes a persistent reservation for the pre-empting initiator. Any commands from the initiators being pre-empted are terminated as if an ABORT TASK management function had been performed by the pre-empted initiator. If a PERSISTENT RESERVATION OUT command is sent that specifies a Pre-empt & Clear service action and no persistent reservation exists for the initiator identified by the Service action Reservation key, it is not an error condition. If the key is registered, however, the Clear portion of the action executes normally.</p> <p>A UNIT ATTENTION condition is established for the pre-empted initiators. The sense key is set to UNIT ATTENTION; the additional sense data is set to RESERVATIONS PREEMPTED. Commands that follow, and retries of commands that timed out because there were cleared are subject to the persistent reservation restrictions set by the pre-empting initiator.</p> <p>The persistent reservation thus created by the pre-empting initiator is defined by the Scope and Type fields of the PERSISTENT RESERVATION OUT command and the corresponding fields of the command's parameter list.</p> <p>The Pre-empt & Clear service action clears any ACA or CA condition associated with the initiator that is pre-empted and clears any tasks with an ACA attribute from that initiator.</p> <p>Any Asynchronous Event Reporting operations in progress that were initiated by the device server are unaffected by a Pre-empt and Clear service action.</p> <p>The reservation key for the other initiators pre-empted are removed by the Pre-empt & Clear service action. The reservation key for an initiator that has sent a Pre-empt & Clear action with its own reservation key specified in the service action's reservation key remains unchanged, although all other specified clearing actions, releasing actions, and reservation actions are performed.</p> <p>Persistent reservations are not superseded by a new persistent reservation from any initiator except via execution of a PERSISTENT RESERVATION OUT that specifies either the Pre-empt or Pre-empt & Clear service action. New persistent reservations not in conflict with an existing persistent reservation execute normally. The persistent reservation of a logical unit or extent that has the same Type value is permitted as long as no conflicting persistent reservations other than the reservations being pre-empted are permitted.</p>

Table 5-67 PERSISTENT RESERVATION OUT Command's Service Action Descriptions (continued)

PERSISTENT RESERVATION OUT Command (5Fh) (continued)

Table Table 5–68 presents the definitions of the characters of the available “Type” values from the Type field of the PERSISTENT RESERVATION IN Read Reservations parameters.

Each of the codes provides handling instructions for READ operations, for WRITE operations, and for subsequent attempts to establish persistent reservations (referred to as “Additional Reservations Allowed” in the table).

Code	Name	Description
0h	READ Shared	<p>READS: Shared; any application client on any initiator may execute commands that perform transfers from the target to the initiator.</p> <p>WRITES: Prohibited; any command from any initiator that performs a transfer from the initiator to the target results in a reservation conflict.</p> <p>ADDITIONAL RESERVATIONS: Allowed; any initiator may reserve the logical unit, extents, or elements as long as the persistent reservations do not conflict with any reservations already known to the device server.</p>
1h	WRITE Exclusive	<p>READS: Shared; any application client on any initiator may execute commands that perform transfers from the target to the initiator.</p> <p>WRITES: Exclusive; any command from any initiator other than the initiator that holds the persistent reservation that attempts a transfer to the target results in a reservation conflict</p> <p>ADDITIONAL RESERVATIONS: Allowed; any initiator may reserve the logical unit, extents, or elements as long as the persistent reservations do not conflict with any reservations already known to the device server.</p>
2h	READ Exclusive	<p>READS: Exclusive; any command from any initiator other than the initiator that holds the persistent reservation that attempts a transfer from the target results in a reservation conflict</p> <p>WRITES: Shared; any application client on any initiator may execute commands that perform transfers to the target from the initiator.</p> <p>ADDITIONAL RESERVATIONS: Allowed; any initiator may reserve the logical unit, extents, or elements as long as the persistent reservations do not conflict with any reservations already known to the device server.</p>

*(continued)**Table 5–68 Persistent Reservation Type Codes and Their Meanings*

PERSISTENT RESERVATION OUT Command (5Fh) (continued)

Code	Name	Description
3h	Exclusive Access	<p>READS: Exclusive; any command from any initiator other than the initiator holding the persistent reservation that attempts a transfer from the target results in a reservation conflict.</p> <p>WRITES: Exclusive; any command from any initiator other than the initiator holding the persistent reservation that attempts a transfer to the target results in a reservation conflict.</p> <p>ADDITIONAL RESERVATIONS: Restricted; any PERSISTENT RESERVATION OUT command with the Reserve service action from any initiator other than the initiator holding the persistent reservation results in a reservation conflict. The initiator that holds the persistent reservation can reserve the logical unit, extents, or elements as long as the persistent reservations do not conflict with any reservations already known to the device server.</p>
4h	Shared Access	<p>READS: Shared; any application client on any initiator may execute commands that perform transfers from the target to the initiator.</p> <p>WRITES: Shared; ; any application client on any initiator may execute commands that perform transfers to the target from the initiator.</p> <p>ADDITIONAL RESERVATIONS: Restricted; any PERSISTENT RESERVATION OUT command with the Reserve service action from any initiator other than the initiator holding the persistent reservation results in a reservation conflict. The initiator that holds the persistent reservation can reserve the logical unit, extents, or elements as long as the persistent reservations do not conflict with any reservations already known to the device server.</p>
5h	WRITE Exclusive, Registrants Only	<p>READS: Shared; any application client on any initiator may execute commands that perform transfers from the target to the initiator.</p> <p>WRITES: Exclusive; any command from an initiator that has not previously performed a Register service action with the device server that attempts a transfer to the target results in a reservation conflict</p> <p>ADDITIONAL RESERVATIONS: Allowed; any initiator may reserve the logical unit, extents, or elements as long as the persistent reservations do not conflict with any reservations already known to the device server.</p>

*(continued)**Table 5-68 Persistent Reservation Type Codes and Their Meanings (continued)*

PERSISTENT RESERVATION OUT Command (5Fh) (continued)

Code	Name	Description
6h	Exclusive Access, Registrants Only	<p>READS: Exclusive; any command from an initiator that has not previously performed a Register service action with the device server that attempts a transfer from the target results in a reservation conflict.</p> <p>WRITES: Exclusive; any command from an initiator that has not previously performed a Register service action with the device server that attempts a transfer to the target results in a reservation conflict</p> <p>ADDITIONAL RESERVATIONS: Allowed; any initiator may reserve the logical unit, extents, or elements as long as the persistent reservations to not conflict with any reservations already known to the device server.</p>
7h - Fh	Reserved	N/A

Table 5-68 Persistent Reservation Type Codes and Their Meanings (continued)

The PERSISTENT RESERVATION OUT command requires a parameter list, illustrated in the following figure and defined in the following table. Each of the fields of the parameter list are sent for every PERSISTENT RESERVATION OUT command, even if the field is not required for the specific Service action and/or Scope values.

Bit	7	6	5	4	3	2	1	0
Byte								
0 – 7	Reservation Key							(LSB)
8 – 15	Service Action Reservation Key							(LSB)
16 – 19	Scope-Specific Address							(LSB)
20	Reserved							APTPL
21	Reserved							
22 – 23	Extent Length							(LSB)

Figure 5-69 PERSISTENT RESERVATION OUT Parameter List — Data Format

PERSISTENT RESERVATION OUT Command (5Fh) (continued)

Data Field	Description
Reservation Key	This field contains an 8-byte token that is provided by the application client to the device server to identify which initiator is the source of the PERSISTENT RESERVATION OUT command. The device server verifies that the Reservation Key in the PERSISTENT RESERVATION OUT command matches the Reservation Key that is registered for the initiator from which the command is received. If there is no match, the device server returns a RESERVATION CONFLICT status. The Reservation Key of the initiator is valid for all Service action and Scope values.
Service Action Reservation Key	This field contains information needed for 3 service actions: the Register service action, the Pre-empt service action, and the Pre-empt & Clear service action. The Service Action Reservation Key is ignored for all other service actions. For the Register service action, the Service Action Reservation Key field contains the new Reservation Key to be registered. For the Pre-empt and the Pre-empt & Clear service actions, the Service Action Reservation Key contains the reservation key of the persistent reservations that are being pre-empted. For the Pre-empt and the Pre-empt & Clear actions, any failure of the Service Action Reservation Key to match any registered keys results in the device server returning a RESERVATION CONFLICT status.
Scope-Specific Address	If the Scope is an Extent reservation, this field contains the Logical Block Address of the extent and the Extent Length field (bytes 22 – 23) contain the number of blocks in the extent. If the Scope signifies an Element reservation, the Scope-Specific Address field contains the Element Address, zero-filled in the most significant bytes to fit the field; the Extent Length is set to 0. If the Service action is Register or Clear, or if the Scope is a Logical Unit reservation, both the Scope-Specific Address and Extent Length fields are set to 0.
APTPL	Activate Persist Through Power Loss. This bit is valid only for Register service actions; it is ignored for all other types of service actions. Support for APTPL set to 1 is optional. If a device server that does not support APTPL receives a 1 in that bit in a Register service action, it returns a CHECK CONDITION status, with the sense key set to ILLEGAL REQUEST and additional sense data set to INVALID FIELD IN PARAMETER LIST. If the last valid APTPL bit value received by the device server is 0, the loss of power in the target releases any persistent reservations and removes all reservation keys. If the last valid APTPL bit value is 1, the logical unit retains all persistent reservations and all reservation keys for all initiators even if power is lost and later returned. The most recently received valid APTPL value from any initiator governs the logical unit's behavior in the event of a power loss.

Table 5-69 PERSISTENT RESERVATION OUT Parameter List — Field Descriptions

PERSISTENT RESERVATION OUT Command (5Fh) (continued)

The table below illustrates which fields are set by the application client and interpreted by the device server for each Service and Scope value.

Service Action	Allowed Scope	Parameters		
		Type	Service Action Reservation Key	Element or Element Parameters
Register	Ignored	Ignored	Valid	Ignored
Reserve	LU	Valid	Ignored	Ignored
Reserve	Extent	Valid	Ignored	Extent Valid
Reserved	Element	Valid	Ignored	Element Valid
Release	LU	Valid	Ignored	Ignored
Release	Extent	Valid	Ignored	Extent Valid
Release	Element	Valid	Ignored	Element Valid
Clear	Ignored	Ignored	Ignored	Ignored
Pre-empt	LU	Valid	Valid	Ignored
Pre-empt	Extent	Valid	Valid	Extent Valid
Pre-empt	Element	Valid	Valid	Element Valid
Pre-empt & Clear	LU	Valid	Valid	Ignored
Pre-empt & Clear	Extent	Valid	Valid	Extent Valid
Pre-empt & Clear	Element	Valid	Valid	Element Valid

Table 5-70 Device Server Interpretation of Service and Scope Value

5.13. PREVENT / ALLOW MEDIUM REMOVAL Command (1Eh)

This command enables or disables the unloading of the tape cartridge.

Bit Byte	7	6	5	4	3	2	1	0
0	Operation Code (1Eh)							
1	Logical Unit Number			Reserved				
2 - 3	Reserved							
4	Reserved							Prevent
5	Unused	Reserved				Flag	Link	

*Figure 5–70 PREVENT / ALLOW MEDIUM REMOVAL Command
Descriptor Block — Data Format*

Field Name	Description
Prevent	<p>When set to 1, the UNLOAD button on the drive's front panel is effectively disabled, and the UNLOAD command does not unload the tape medium or the cartridge. The PREVENT / ALLOW status in the device is maintained separately by each initiator.</p> <p>When set to 0, the prevent state corresponding to that initiator is cleared. When all initiators have cleared their prevent states, the UNLOAD button and UNLOAD commands are enabled. By default, after power up, a hard reset, or Bus Device Reset message, the prevent medium removal function is cleared.</p> <p>If a Media Loader device is present, its MOVE MEDIUM command is prevented from removing a cartridge if PREVENT has been enabled.</p>

*Table 5–71 PREVENT / ALLOW MEDIUM REMOVAL Command
Descriptor Block — Field Descriptions*

5.14. READ Command (08h)

This command transfers one or more data blocks or bytes to the initiator starting with the next block on the tape.

Bit	7	6	5	4	3	2	1	0
Byte								
0	Operation Code (08h)							
1	Logical Unit Number			Reserved			SILI	Fixed
2 - 4	(MSB) Transfer Length (LSB)							
5	Unused		Reserved			Flag		Link

Figure 5–71 READ Command Descriptor Block — Data Format

Field Name	Description
SILI	<p>Suppress Incorrect Length Indicator. If the SILI bit is set to 1 and the Fixed bit is set to 1, the target terminates the command with CHECK CONDITION status, sense key set to ILLEGAL REQUEST, and additional sense code of INVALID FIELD IN CDB.</p> <p>If the SILI bit is 0 and the actual block length is different than the specified transfer length, a CHECK CONDITION status is returned. Within the sense data, the Incorrect Length Indicator (ILI) bit and Valid bit will be set to 1. The sense key field specifies NO SENSE. The information bytes are set to the difference (residue) between the requested transfer length and the actual block length., or, in Fixed Block mode, the difference (residue) between the requested number of blocks and the actual number of blocks read. No more than transfer length blocks are transferred to the initiator and the tape is logically positioned after the block (EOM side).</p>

Table 5–72 READ Command Descriptor Block — Field Descriptions

READ Command (08h) (continued)

Field Name	Description
Fixed	<p>This bit specifies whether fixed-length or variable-length blocks are to be transferred, and gives meaning to the Transfer Length field of the READ command.</p> <p>When set to 0, variable-block mode is requested. A single block is transferred with the Transfer Length specifying the maximum number of bytes the initiator has allocated for the returned data.</p> <p>When the Fixed bit is set to 1, the Transfer Length specifies the number of blocks to be transferred to the initiator. This is valid only if the logical unit is currently operating in Fixed Block mode.</p> <p>When the Transfer Length is 0, no data is transferred and the current position on the logical unit does not change. This is not an error condition.</p> <p>A successful READ with Fixed bit set to 1 transfers (current block length) x (# of blocks x block size) bytes of data to the host. Upon termination of READ, the medium is logically positioned after the last block of data transferred (EOM).</p> <p>Note that a READ command in fixed mode with an odd block size returns a CHECK CONDITION: the DLT8000 tape drive does not support odd block number transfers.</p>

*Table 5–72 READ Command Descriptor Block — Field Descriptions (continued)***Filemark, End-of-Data, and End-of-Medium/Partition Handling**

If the tape drive reads a Filemark, it returns a CHECK CONDITION status. Within the sense data, the Filemark and Valid bits are set and the Sense Key field is set to NO SENSE. The information fields contain the residue count. The Additional Sense Code and Additional Sense Code Qualifier fields are set to FILEMARK DETECTED. Upon termination, the medium is logically positioned after the Filemark.

If the drive detects End-of-Data (EOD) during a READ, the drive returns a CHECK CONDITION status. Within the sense data, the Valid bit is set and the Sense Key field is set to BLANK CHECK. The End-of-Medium (EOM) bit may be set if the drive determines that the tape is positioned past the PSEN marker. The information fields contain the residue count. The Additional Sense Code Qualifier fields are set. Upon termination, the medium is physically positioned before EOD and after the last block on tape.

READ Command (08h) (continued)

The meaning of EOM is different for a READ command than for a WRITE-related command. EOM is reported only when the physical EOM or End-of-Partition (EOP) is encountered. The drive returns a CHECK CONDITION status. The EOM and Valid bits are set and the Sense Key is set to MEDIUM ERROR. The information fields contain the residue count and the Additional Sense Code and Additional Sense Code Qualifier fields are set to EOM/P DETECTED. The tape is physically positioned at EOM/P.

If any READ command cannot be successfully completed, the drive returns a CHECK CONDITION status. Further commands should attempt to move past the anomaly and to complete successfully.

5.15. READ BLOCK LIMITS Command (05h)

The READ BLOCK LIMITS command directs the tape drive to report its block length limits.

Bit	7	6	5	4	3	2	1	0
Byte								
0	Operation Code (05h)							
1	Logical Unit Number			Reserved				
2 - 4	Reserved							
5	Unused		Reserved			Flag		Link

Figure 5-72 READ BLOCK LIMITS Command Descriptor Block — Data Format

READ BLOCK LIMITS Command (05h) (continued)

The READ BLOCK LIMITS data shown below is sent during the DATA IN phase of the command. The command does not reflect the currently selected block size, only the available limits. MODE SENSE is the command that returns the current block size.

Bit	7	6	5	4	3	2	1	0
Byte								
0	Reserved *							
1 - 3	(MSB)	Maximum Block Length						(LSB)
4 - 5	(MSB)	Minimum Block Length (0001h)						(LSB)

* In SCSI-3 configurations, Byte 0 appears as shown below:

0	Reserved	Granularity
---	----------	-------------

The **Granularity** field is described in the table below.

Figure 5–73 READ BLOCK LIMITS Data — Data Format

Field Name	Description
Granularity (SCSI-3 Only)	<p>This field indicates the supported block size granularity. The DLT8000 tape drive supports all block sizes n such that n minus the minimum block length limit is a multiple of 2^x (where x is the value in the Granularity bits), and n is greater than or equal to the Minimum Block Length Limit and less than or equal to the Maximum Block Size Limit. For the DLT8000 system, the content of the Granularity field is 1 (since block sizes must be a multiple of 2; $2^1 = 2$).</p> <p>For backward compatibility, the DLT8000 will process requests that do not meet Granularity criteria, except for Odd-byte Multiple Block Fixed Block WRITE commands when connected to a Wide (16-bit) SCSI bus.</p>
Maximum Block Length	The value in this field indicates the maximum block size. The tape drive supports a maximum block length of 16,777,214 (16 MB-2) for 10, 15,20, 35, or 40 GB format.
Minimum Block Length	The value in this field indicates the minimum block size. The tape drive supports a minimum block length of 2 bytes.

Table 5–73 READ BLOCK LIMITS Data — Field Descriptions

5.16. READ BUFFER Command (3Ch)

The READ BUFFER command is used in conjunction with WRITE BUFFER as a diagnostic function for testing the drive's data buffer for possible diagnostic data and for checking the integrity of the SCSI bus. In addition, by using buffers 1 and 2, the READ BUFFER command allows the contents of the tape system's local RAM/EEPROM, and DRAM to be transferred over the SCSI bus. Buffers 1 and 2 provide a diagnostic capability for the system's firmware.

Bit	7	6	5	4	3	2	1	0
Byte								
0	Operation Code (3Ch)							
1	Logical Unit Number			Reserved			Mode	
2	Buffer ID							
3 - 5	(MSB) Buffer Offset (LSB)							
6 - 8	(MSB) Allocation Length (LSB)							
9	Unused		Reserved				Flag	Link

Figure 5-74 READ BUFFER Command Descriptor Block — Data Format

READ BUFFER Command (3Ch) (continued)

Field Name	Description								
Mode	The tape drive supports the following values within this field. If any non-supported value is set, the drive terminates the command with a CHECK CONDITION status, ILLEGAL REQUEST sense key set.								
	<table border="1"> <thead> <tr> <th>Mode</th> <th>Description</th> </tr> </thead> <tbody> <tr> <td>000b</td> <td>Combined Header and Data (see 5.16.1)</td> </tr> <tr> <td>010b</td> <td>Data (see 5.16.2)</td> </tr> <tr> <td>011b</td> <td>Descriptor (see 5.16.3)</td> </tr> </tbody> </table>	Mode	Description	000b	Combined Header and Data (see 5.16.1)	010b	Data (see 5.16.2)	011b	Descriptor (see 5.16.3)
Mode	Description								
000b	Combined Header and Data (see 5.16.1)								
010b	Data (see 5.16.2)								
011b	Descriptor (see 5.16.3)								
Buffer ID	<p>Must be 0, 1, or 2.</p> <p>Buffer 0: This 1100 KB buffer is intended to be used in conjunction with the WRITE BUFFER command to provide a diagnostic capability for testing the SCSI bus and/or hardware integrity.</p> <p>Buffer 1: Choosing Buffer 1 results in the tape system transferring the contents of controlled scratchpad RAM and EEPROM over the SCSI bus. For DLT8000 tape systems, a total of 264K is transferred (256K for RAM, 8K for EEPROM).</p> <p>Buffer 2: Choosing Buffer 2 results in the tape system transferring the contents of data cache RAM over the SCSI bus. For DLT8000 tape systems, a total of 8 MB is transferred.</p>								
Buffer Offset	The Buffer Offset field allows the host to specify where the start of the data is within the buffer.								
Allocation Length	This field specifies the maximum number of bytes that the initiator has allocated for returning data. The host uses this field to limit the size of data transfers to its own internal buffer size.								

Table 5–74 READ BUFFER Command Descriptor Block — Field Descriptions

The host should first send a READ BUFFER command, in Descriptor mode, to determine the size of the buffer being returned. In response to the READ BUFFER command, the tape system returns four bytes of data, three of which contain the size of the buffer. The host can then use this data to establish the Buffer Offset/Allocation Length fields of the CDB. Once the size of the buffer is known, Mode 2 (Data Only, see Section 5.16.2) can be used to transfer the data across the SCSI Bus.

*READ BUFFER Command (3Ch) (continued)***5.16.1. Combined Header and Data Mode**

In this mode, the tape drive returns a 4-byte header followed by data bytes. The drive terminates the DATA IN phase when the Allocation Length bytes of header and data have been transferred or when all available data has been transferred to the initiator, whichever is less. The 4-byte READ BUFFER header is followed by data bytes from the target data buffer. The figure below illustrates the format of the header.

Bit	7	6	5	4	3	2	1	0
Byte								
0	Reserved							
1 - 3	(MSB)	Available Length						(LSB)

Figure 5–75 READ BUFFER Header — Data Format

Field Name	Description
Available Length	This field specifies the total number of data bytes available in the target's buffer. This number is not reduced to reflect the allocation length, nor is it reduced to reflect the actual number bytes written using the WRITE BUFFER command. Following the READ BUFFER header, the target transfers data from its data buffer.

Table 5–75 READ BUFFER Header — Field Descriptions

*READ BUFFER Command (3Ch) (continued)***5.16.2. Data Mode**

In this mode, the DATA IN phase contains only buffer data.

5.16.3. Descriptor Mode

In this mode, a maximum of four bytes of READ BUFFER descriptor information is returned. The tape drive returns the descriptor information for the buffer specified by the Buffer ID. In this mode, the drive does not reject the invalid Buffer IDs with a CHECK CONDITION status, but returns all zeros in the READ BUFFER descriptor.

The Offset Boundary (Figure 5-76) is 12 (0Ch), indicating that buffer offsets should be integral multiples of 4 K.

Bit	7	6	5	4	3	2	1	0
Byte								
0	Offset Boundaries (0Ch)							
1 - 3	(MSB)	Buffer Capacity						(LSB)

Figure 5-76 READ BUFFER Descriptor — Data Format

5.17. READ POSITION Command (34h)

The READ POSITION command is used to read a position identifier or SCSI Logical Block Address (LBA). The LOCATE command uses this identifier to position back to this same logical position in a high-performance fashion.

Bit	7	6	5	4	3	2	1	0
Byte								
0	Operation Code (34h)							
1	Logical Unit Number				Rsv'd	TCLP	Long	BT
2 - 8	Reserved							
9	Unused	Reserved					Flag	Link

Figure 5-77 READ POSITION Command Descriptor Block — Data Format

Field Name	Description
TCLP	Total Current Logical Position. When = 1, data returned includes block, filemark, and setmark position and fits format described in Section 5.17.2. When = 0, the data takes the SCSI-2 format described in Section 5.17.1. This bit indicates the drive returns data specifying the partition, file, and set number with the current logical position (long form). A TCLP bit of 0 indicates the device server will return data specifying the first and last block location with the number of bytes and blocks in the buffer (short form).
Long	When the Long bit = 1, it indicates the server will return 32 bytes of data; a value of 0 indicates the device server will return 20 bytes of data. Both the Long bit and the TCLP bit must both be set to 1 or 0. If these bits have different values, the drive returns CHECK CONDITION, ILLEGAL REQUEST.
BT	Block Type. This bit indicates how the position is to be interpreted. Since the tape drive uses the same logical block regardless of the setting of this bit, the setting is ignored. The logical block address values include all recorded objects: blocks and filemarks.

Table 5-76 READ POSITION Command Descriptor Block — Field Descriptions

*READ POSITION Command (34h) (continued)***NOTE**

The drive returns CHECK CONDITION with UNIT NOT READY sense key with the READ POSITION command if the media is not ready to be accessed.

5.17.1. Standard READ POSITION Data

When TCLP and Long bits are both set to 0, the data takes the following format:

Bit Byte	7	6	5	4	3	2	1	0
0	BOP	EOP	BCU	BYCU	Rsv'd	BPU (0)	PERR	Rsv'd
1	Partition Number							
2 - 3	Reserved							
4 - 7	(MSB)	First Block Location						(LSB)
8 - 11	(MSB)	Last Block Location						(LSB)
12	Reserved							
13 - 15	(MSB)	Number of Blocks in Buffer						(LSB)
15 - 19	(MSB)	Number of Bytes in Buffer						(LSB)

Figure 5-78 READ POSITION — Data Format

READ POSITION Command (34h) (continued)

Field Name	Description
BOP	Beginning of Partition. When set to 1, indicates that the logical unit is at the beginning of partition in the current partition. When 0, indicates that the current logical position is not at the beginning of partition. Since the tape drive does not support more than one partition, the value of this field will be 1 when at BOT.
EOP	End of Partition. When set to 1, indicates that the logical unit is positioned between early warning and the end of partition in the current partition. When 0, it indicates that the current logical position is not between early warning and end of partition.
BCU	Block Count Unknown
BYCU	Byte Count Unknown
BPU	Block Position Unknown. This bit is never set: the setting of the Block Type (BT) bit of READ POSITION's CDB does not affect the block address values returned.
PERR	Position Error
First Block Location	The block address associated with the current logical position: the next block to be transferred between the target and initiator if a READ or WRITE command is issued.
Last Block Location	The block address associated with the current physical position: the next block to be transferred to tape medium and from the target's buffer. If the buffer is empty, or has only a partial block, the same value as First Block Location is reported. The first block or filemark written onto the tape medium is at address 0.
Number of Bytes in Buffer	The number of data blocks in the target's buffer.
Number of Bytes in Buffer	The number of data bytes in the buffer that have not been written to the tape medium.

Table 5-77 READ POSITION Data — Field Descriptions

*READ POSITION Command (34h) (continued)***5.17.2. Total Current Logical Position**

When TCLP and Long bits are both set to 1, the data takes the following format:

Bit	7	6	5	4	3	2	1	0
Byte								
0	BOP	EOP	Reserved		Rsv'd	BPU (0)	Reserved	
1 - 3	Reserved							
4 - 7	(MSB)	Partition Number						(LSB)
8 - 15	(MSB)	Block Number						(LSB)
16 - 23	(MSB)	File Number						(LSB)
24 - 31	(MSB)	Set Number						(LSB)

Figure 5–79 READ POSITION (Long Form) — Data Format

Field Name	Description
BOP	Beginning of Partition. When set to 1, indicates that the logical unit is at the beginning of partition in the current partition. When 0, indicates that the current logical position is not at the beginning of partition. Since the tape drive does not support more than one partition, the value of this field will be 1 when at BOT.
EOP	End of Partition. When set to 1, indicates that the logical unit is positioned between early warning and the end of partition in the current partition. When 0, it indicates that the current logical position is not between early warning and end of partition.
MPU	Mark Position Unknown. Values in File Number and Set Number are invalid.
BPU	Block Position Unknown. This bit is never set: the setting of the Block Type (BT) bit of READ POSITION's CDB does not affect the block address values returned.
Partition Number	Partition number for the current logical position.
Block Number	Number of logical blocks between beginning of partition and current logical position. Filemarks and Setmarks count as one logical block each.
File Number	Number of Filemarks between beginning of partition and current logical position.
Set Number	Number of Setmarks between beginning of partition and current logical position.

Table 5–78 READ POSITION (Long Form) Data — Field Descriptions

5.18. RECEIVE DIAGNOSTIC RESULTS Command (1Ch)

The RECEIVE DIAGNOSTIC RESULTS command fetches the results of the last SEND DIAGNOSTIC command sent to the tape drive.

Bit Byte	7	6	5	4	3	2	1	0
0	Operation Code (1Ch)							
1	Logical Unit Number			Reserved				
2	Reserved							
3 - 4	(MSB) Allocation Length							(LSB)
5	Unused		Reserved			Flag		Link

Figure 5–80 RECEIVE DIAGNOSTIC RESULTS Command Descriptor Block — Data Format

Field Name	Description
Allocation Length	Specifies the number of bytes of diagnostic page results the drive is allowed to send to the initiator.

Table 5–79 RECEIVE DIAGNOSTIC RESULTS Command Data — Field Descriptions

RECEIVE DIAGNOSTIC RESULTS Command (1Ch) (continued)

The following data is returned by the drive as a result of the RECEIVE DIAGNOSTIC command. Note that a REQUEST SENSE command should be used to obtain more detailed information following a CHECK CONDITION on a SEND DIAGNOSTIC command.

Bit Byte	7	6	5	4	3	2	1	0
0	Controller Present Flag							
1	Controller Error Flag							
2	Drive Present Flag							
3	Drive Error Flag							
4	Media Loader Present Flag							
5	Media Loader Error Flag							

Figure 5–81 RECEIVE DIAGNOSTIC RESULTS — Data Format

This information indicates which of the main components of the tape drive subsystem may have failed diagnostic testing.

NOTE

Running BHC Diagnostics via the SEND DIAGNOSTIC command will not have any affect on the flags in Bytes 0 – 5. Note that the BHC feature is provided for use only by a trained service provider.

5.19. RELEASE UNIT (6) Command (17h)

The RELEASE UNIT (6) command is a 6-byte command that releases the drive if it is currently reserved by the requesting initiator. It is not an error to release the tape drive if it is not currently reserved by the requesting initiator. If the tape drive is reserved by another initiator, however, it is not released; the tape drive is only released from the initiator that issued the RELEASE command.

Bit Byte	7	6	5	4	3	2	1	0
0	Operation Code (17h)							
1	Logical Unit Number			3rd Pty	Third Party Device ID			Rsv'd
2	Reserved							
3	Reserved							
4	Reserved							
5	Unused		Reserved			Flag		Link

Figure 5–82 RELEASE UNIT (6) Command Descriptor Block — Data Format

RELEASE UNIT (6) Command (17h) (continued)

Field Name	Description
3rdPty	The third party release option for RELEASE UNIT allows an initiator to release a logical unit that was previously reserved using the third-party reservation option. If this bit is 0, then the third-party release option is not requested. If this bit is set to 1, the drive is released if it was originally reserved by the same initiator using the third-party reservation option and if the tape drive is the same SCSI device specified in the Third Party Device ID field.
Third Party Device ID	Required if the 3rdPty bit is 1. This field specifies the SCSI ID of the initiator whose third party reservation is being released. This field must be set if the initiator of the original third party RESERVE is the source of the RELEASE.

*Table 5–80 RELEASE UNIT (6) Command Data — Field Descriptions***MEDIA CHANGER CONSIDERATIONS**

The optional Element reservation feature defined for Medium Changer devices in the SCSI-2 ANSI specification is not supported. The RELEASE command is defined the same as for the tape drive. The whole loader unit can be released. RESERVE / RELEASE of the Loader and Drive LUNs are handled independently.

5.20. RELEASE UNIT (10) Command (57h)

The RELEASE UNIT and the RESERVE UNIT commands are used for contention resolution in multiple-initiator systems. The RELEASE (10) command is a 10-byte command used to release a previously reserved logical unit. The drive will not return an error if the initiator attempts to release a reservation that is not currently valid.

Bit Byte	7	6	5	4	3	2	1	0
0	Operation Code (57h)							
1	Reserved			3rdPty	Reserved		LongID	Extent
2	Reservation Identification							
3	Third Party Device ID							
4 - 6	Reserved							
7 - 8	(MSB)	Parameter List Length						(LSB)
9	Unused	Reserved				Flag	Link	

Figure 5–83 RELEASE UNIT (10) Command Descriptor Block — Data Format

RELEASE UNIT (10) Command (57h) (continued)

Field	Description
3rdPty	Third Party Release allows an initiator to release a logical unit that was previously reserved. If the value in this field is 0, third party release is not requested. If 3rdPty = 1, then the device server shall release the specified logical unit, but only if the initiator ID, 3rdPty bit, and third party device ID are identical when compared to the RESERVE command that established the reservation.
LongID	If the Long ID bit is set to 1, the Parameter List Length is 8 and the eight bytes of the parameter list carry the device ID of the third party device; the contents of the Third Party Device ID in the CDB (byte 3) are ignored.
Third Party Device ID	If the Third Party Device ID value that is connected with the reservation release is smaller than 255, the LongID bit may be 0 and the ID value sent in the CDB. If LongID bit = 0, the Parameter List Length field also = 0. If the Third Party Device ID value is greater than 255, LongID = 1. Device servers that support device IDs greater than 255 will accept commands with LongID = 1; device servers that do not support IDs greater than 255 may reject commands with LongID set = 1. Device ID formats are protocol-specific.
Parameter List Length	The contents of this field specify the length, in bytes, of the parameter list that will be transferred from the initiator to the target.
Extent	The drive supports reservations only on entire logical units. The value must be 0.
Reservation Identification	Any value in this field is ignored by the drive.

NOTE: Assuming that the RELEASE UNIT (10) Command Descriptor Block is valid, the drive always returns a GOOD status for this command. An actual release only happens if the initiator has the unit reserved for itself or a third-party initiator.

Table 5–81 RELEASE UNIT (10) Command — Field Descriptions

5.21. REPORT DENSITY SUPPORT Command (44h)

The REPORT DENSITY SUPPORT command is a 10-byte command used to request that information about the densities supported by the logical unit be sent to the application client. Note that a reservation conflict will occur when a REPORT DENSITY SUPPORT command is received from any initiator other than the one holding a logical unit reservation.

The figure below illustrates the format of the REPORT DENSITY SUPPORT command; the table that follows explains the data fields of the command.

Bit	7	6	5	4	3	2	1	0
Byte								
0	Operation Code (44h)							
1	Reserved							Media
2 - 6	Reserved							
7 - 8	(MSB) Allocation Length (LSB)							
9	Unused	Reserved					Flag	Link

Figure 5–84 REPORT DENSITY SUPPORT Command Descriptor Block — Data Format

REPORT DENSITY SUPPORT Command (44h) (continued)

Data Field	Description
Media	<p>When this bit = 0, it indicates that the device server will return density support data blocks for densities supported by the logical unit for <i>any supported media</i>.</p> <p>When this bit = 1, it indicates that the device server will return density support data blocks for densities supported by the <i>mounted medium</i>.</p>
Allocation Length	This value in this field specifies the maximum number of bytes that the device server may return.

Table 5–82 REPORT DENSITY SUPPORT Command — Field Descriptions

The REPORT DENSITY SUPPORT command returns a header followed by one or more density support data blocks. The data blocks are presented in ascending numerical order of the primary density code value.

The figure below illustrates the REPORT DENSITY SUPPORT header.

Bit	7	6	5	4	3	2	1	0
Byte								
0 - 1	Available Density Support Length							(LSB)
2 - 3	Reserved							
4 - n	Density Support Data Block Descriptors							

Figure 5–85 REPORT DENSITY SUPPORT Header — Data Format

The following table provides a description of the Available Density Support Length field; the Density Support Data Block Descriptors field has a separate illustration and description table.

REPORT DENSITY SUPPORT Command (44h) (continued)

Data Field	Description
Available Density Support Length	This value within this field specifies the number of bytes in the data that follows available to be transferred. Note that this length value does not include this field. The value within this field is equal to 2 more than an integer multiple of 52 (the length in bytes of a density support data block descriptor).
Allocation Length	This value in this field specifies the maximum number of bytes that the device server may return.

Table 5-83 REPORT DENSITY SUPPORT Header — Field Descriptions

The figure and table that follow provide information about the Density Support Data Block Descriptor field of the header.

REPORT DENSITY SUPPORT Command (44h) (continued)

Bit Byte	7	6	5	4	3	2	1	0
0	Primary Density Code							
1	Secondary Density Code							
2	WRTOK	DUP	DEFLT	Reserved				
3 - 4	Reserved							
5 - 7	(MSB)	Bits Per MM						(LSB)
8 - 9	(MSB)	Media Width						(LSB)
10-11	(MSB)	Tracks						(LSB)
12-15	(MSB)	Capacity						(LSB)
16-23	(MSB)	Assigning Organization						(LSB)
24-31	(MSB)	Density Name						(LSB)
32-51	(MSB)	Description						(LSB)

Figure 5-86 Density Support Data Block Descriptor — Data Format

REPORT DENSITY SUPPORT Command (44h) (continued)

Data Field	Description
Primary Density Code	This field contains the value returned by a MODE SENSE command for the density described in the remainder of the Density Support Data Block Descriptor. Allowable Density Codes for the tape system are shown in Table (To Be Supplied).
Secondary Density Code	When multiple density code values are assigned to the same recording technology, this field lists the equivalent density code value. If no secondary density code exists, the device server returns the primary device code value in this field.
WR TOK	Write OK. When this bit = 0, it indicates that the drive does not support writing to the media with this density. When this bit = 1, it indicates that the drive is capable of writing this density to either the currently mounted medium (if Media bit in the Command Block Descriptor = 1) or for some media (if Media bit in the Command Block Descriptor = 0). Note that all density code values returned by the Report Density Support command are supported for READ operations.
DUP	Duplicated. When this bit = 0, it indicates that this Primary Density Code has exactly one density support data block. When this bit = 1, it indicates that this Primary Density Code is specified in more than one density support data block.
DEFLT	Default. When this bit = 0, it indicates that this is not the default density of the tape drive. If either the Primary Density Code or the Secondary Density Code is 0, the DEFLT bit will be 1. If neither the Primary or Secondary Density Code is 0 and DEFLT is 1, the logical unit will accept a MODE SELECT header with a density code of 00h as equivalent to the Primary and Secondary Density Codes. NOTE: The default density of the logical unit may vary depending on the currently mounted media. Multiple codes may return a DEFLT bit of 1 when the Media bit is 0 since more than one default may be possible.

*(continued)**Table 5-84 Density Support Data Block Descriptor — Field Descriptions*

REPORT DENSITY SUPPORT Command (44h) (continued)

Data Field	Description
Bit Per MM	Bits per millimeter. The value in this field indicates the number of bits per millimeter per track as recorded on the tape medium. Note that the value is rounded up if the fractional value of the actual value is greater than or equal to 0.5. A value of 00h indicates that the number of bits per millimeter does not apply to this logical unit.
Media Width	The value in this field indicates the width of the tape medium supported by this density. This field has units in tenths of millimeters.
Tracks	The value in this field indicates the number of data tracks supported on the medium by this density.
Capacity	<p>If the Media bit = 0, the Capacity field indicates the approximate capacity of the longest supported medium. If the Media bit = 1, the Capacity field indicates the approximate capacity of the current medium. The capacity assumes that compression is disabled. If this density does not support an uncompressed format, the capacity assumes that compression is enabled using “average” data. The capacity also assumes that the media is in good condition and that normal data and block sizes are used. The value is given in units of megabytes (10⁶ bytes). Note that the logical unit does not guarantee that this space is actually available in all cases.</p> <p>The Capacity field is intended to be used by the client to determine that the correct density is being used, especially when a lower density format is required for interchangeability.</p>
Assigning Organization	This field contains 8 bytes of ASCII data identifying the organization responsible for the specifications that define the values in the density support data block.
Density Name	This field contains 8 bytes of ASCII data identifying the document that is associated with this density support data block.
Description	This field contains 20 bytes of ASCII data describing the density.

Table 5-84 Density Support Data Block Descriptor — Field Descriptions (continued)

5.22. REPORT LUNS Command (A0h)

The REPORT LUNS command requests that the peripheral device logical unit numbers of known logical units in the target be sent to the applications client. The command only returns information about the logical units to which commands may be sent.

Bit	7	6	5	4	3	2	1	0
Byte								
0	Operation Code (A0h)							
1 - 5	Reserved							
6 - 9	(MSB)	Allocation Length						(LSB)
10	Reserved							
11	Unused	Reserved				Flag	Link	

Figure 5-87 REPORT LUNS Command Descriptor Block — Data Format

Field	Description
Allocation Length	If the Allocation Length is not sufficient to contain the logical unit number values for all configured logical units, the device server still reports as many logical number values as will fit in the Allocation Length.
	The format of the report of configured logical units is shown in Figure 5-88.

Table 5-85 REPORT LUNS Command Descriptor Block—Field Description

REPORT LUNS Command (0Ah) (continued)

Bit	7	6	5	4	3	2	1	0
Byte								
0 - 3	(MSB) LUN List Length (n - 7)							(LSB)
4 - 7	Reserved							
8 - 15	(MSB) LUN (first LUN)							(LSB)
	•							•
	•							•
	•							•
n-7 - n	LUN (last LUN, if more than one)							

Figure 5-88 LUN Reporting Parameter List — Data Format

The LUN List Length field contains the length in bytes of the LUN list that can be transferred. The LUN list length equals the number of logical unit numbers reported multiplied by eight. If the allocation length in the CDB is too small to allow transfer of information about all of the logical units configured, the LUN list length value is not adjusted to reflect the truncation.

5.23. REQUEST SENSE Command (03h)

The REQUEST SENSE command causes the tape drive to transfer detailed sense data to the initiator.

Bit	7	6	5	4	3	2	1	0
Byte								
0	Operation Code (03h)							
1	Logical Unit Number			Reserved				
2	Reserved							
3	Reserved							
4	Allocation Length							
5	Unused		Reserved				Flag	Link

Figure 5–89 REQUEST SENSE Command Descriptor Block — Data Format

Field Name	Description
Allocation Length	This field specifies the maximum number of sense bytes to be returned. The tape drive terminates the transfer when this number of bytes has been transferred or when all available sense data has been transferred to the host, whichever is less.

Table 5–86 REQUEST SENSE Command Data — Field Descriptions

REQUEST SENSE Command (03h) (continued)

The REQUEST SENSE command causes the tape drive to transfer detailed sense data to the initiator.

The sense data is valid for a CHECK CONDITION or RESERVATION CONFLICT status returned on the previous command. The sense data bytes are preserved by the tape drive until retrieved by a REQUEST SENSE command, or until the receipt of any other command from the same initiator, though some commands, such as INQUIRY, do not change sense data.

If the tape drive receives an unsolicited REQUEST SENSE, it returns sense data with the appropriate values in the End of Media (EOM), Sense Key, Additional Sense Code, and Additional Sense Code Qualifier. The positional information provided reflects the logical position of the tape drive. The tape drive returns information based on the non-diagnostic data in its buffer as well as the data on tape medium. Additionally, bytes 25 through 28 contain the amount of tape to be written in 4 KB blocks.

REQUEST SENSE does not cause the drive to flush its buffered data to tape. Therefore, if the host requires the exact physical positioning of the tape medium, it should precede the REQUEST SENSE command with a WRITE FILEMARKS command with length 0 (Immed=0) specified. This forces the tape drive to flush any currently-buffered data to tape. A subsequent REQUEST SENSE command returns the actual physical (and logical) position of the tape drive to the initiator.

The following illustration portrays the format of REQUEST SENSE DATA.

REQUEST SENSE Command (03h) (continued)

Bit	7	6	5	4	3	2	1	0
Byte								
0	Valid	Error Code						
1	Segment Number (0)							
2	Filemark	EOM	ILI	Reserved	Sense Key			
3 - 6	(MSB) Information Bytes							(LSB)
7	Additional Sense Length							
8 - 11	(MSB) Command-Specific Information Bytes							(LSB)
12	Additional Sense Code							
13	Additional Sense Code Qualifier							
14	Sub-Assembly Code (0)							
15	SKSV	C/D	Reserved		BPV	Bit Counter		
16 - 17	(MSB) Field Pointer							(LSB)
18	Internal Status Code (VU)							
19 - 20	Tape Motion Hours							
21 - 24	Power On Hours							
25 - 28	Tape Remaining							
29	Reserved							

Figure 5–90 REQUEST SENSE — Data Format

REQUEST SENSE Command (03h) (continued)

Field Name	Description
Valid	When set to 1, this field indicates that the information bytes contain valid information as defined in the ANSI SCSI-2 specification.
Error Code	<p>A value of 70h indicates a current error – the report is associated with the most recently received command.</p> <p>A value of 71h indicates a deferred error – the report is associated with a previous command and not as a result of the current command.</p> <p>No other values are returned in this field.</p>
Segment Number	This value of this byte is always 0.
Filemark	This bit indicates that the current command has read a Filemark.
EOM	End of Medium. This bit indicates that an End of Medium condition (End of Partition or Beginning of Partition) exists. The warning is also given by setting the Sense Key to NO SENSE and the Additional Sense Qualifier to End of Partition or Beginning of Partition.
ILI	Incorrect Length Indicator. This bit indicates that the requested logical block length did not match the logical block length of the data on the tape medium. Only READ or VERIFY may cause this bit to be set.
Sense Key	In most cases, Additional Sense Code and/or Qualifier information is available. The codes and qualifiers are covered in detail in Table 5-89.
Information Bytes	These bytes contain the differences (residue) of the requested length minus the actual length in bytes, blocks, or Filemarks, as determined by the command. Negative values are indicated by two's complement notation. The bytes are valid for all READ, WRITE, SPACE, and VERIFY tape commands for which a CHECK CONDITION status has been generated. The information bytes are 0 for MODE SELECT / SENSE, INQUIRY, READ BLOCK LIMITS, and TEST UNIT READY.

*(continued)**Table 5–87 REQUEST SENSE Data — Field Descriptions*

REQUEST SENSE Command (03h) (continued)

Field Name	Description
Additional Sense Length	This field specifies the number of additional sense bytes to follow. If the Allocation Length of the Command Descriptor Block is too small to transfer all of the Additional Sense bytes, the Additional Sense Length is not adjusted to reflect the truncation.
Command Specific Information Bytes	Command Specific Information Bytes can be logged by the operating system on error conditions. On tape medium errors, such an entry usually contains the current SCSI Logical Block Address.
Additional Sense Code	This field (and the field for Additional Sense Code Qualifier) provide additional information about the Sense Key and cause of a CHECK CONDITION status. Additional Sense Codes are discussed in detail later in this chapter.
Additional Sense Code Qualifier	This field (and the field for Additional Sense Code) provide additional information about the Sense Key and cause of a CHECK CONDITION status. Additional Sense Code Qualifiers are discussed in detail later in this chapter.
Sub-Assembly Code	Not used. Returned as 0.
SKSV	Sense-Key Specific Valid. When = 1, indicates that the Sense Key specific field is as defined by the International Standard.
C/D	Command / Data. When set to 1, this field indicates that the illegal parameter is contained in the Command Descriptor Block. A C/D set to 0 indicates that the illegal parameter is in the Parameter List from the initiator.
BPV	Bit Pointer Valid. When set to 1, this field indicates that the Bit Pointer field is valid and designates which bit of the byte designated by the field pointer is in error. For a multi-bit field, it points to the most significant bit of the field.
Field Pointer	This field indicates which byte of the Command Descriptor Block or Parameter List is in error. For a multi-byte field, the most significant byte is indicated.
Internal Status Code	Internal Status Codes are explained in detail in Appendix A.

*(continued)**Table 5–87 REQUEST SENSE Data — Field Descriptions (continued)*

REQUEST SENSE Command (03h) (continued)

Field Name	Description
Tape Motion Hours	This field reports the number of tape motion (i.e., head wear) hours. Format is given as a hexadecimal word (2 bytes).
Power On Hours	This field reports the total number of hours that drive power has been applied since its last power on cycle (not total power on hours over the device's lifetime). Format is given as a hexadecimal longword (4 bytes).
Tape Remaining	This field reports the amount of tape remaining in 4 KB (4096 bytes) blocks.

Table 5–87 REQUEST SENSE Data — Field Descriptions (continued)

REQUEST SENSE Command (03h) (continued)

Sense Key	Description
0h	NO SENSE. Check the Filemark/EOM/ILI bits and the Additional Sense Code/Additional Sense Code Qualifier bytes.
1h	RECOVERED ERROR. This can be caused by rounding of Mode Parameters on a MODE SELECT, or may report that READ/WRITE error rates are reaching subsystem specification limits for optimal operation. The device may still be able to continue to function without any unrecovered errors for a long period of time, however. No CHECK CONDITION is generated unless the PER bit of Mode Page 01h is set.
2h	NOT READY. The tape medium is not ready for tape operation commands. Tape medium might not be present in the drive or may be in the process of loading or calibrating.
3h	MEDIUM ERROR. An unrecoverable WRITE, READ, or positioning error has occurred. Detailed device-specific information may be available.
4h	HARDWARE ERROR. The Additional Sense Code / Additional Sense Code Qualifier fields may present more specific information.
5h	ILLEGAL REQUEST. The Command Descriptor Block or supplied parameter data had an unsupported or illegal operation specified. Check bytes 15, 16, and 17.
6h	UNIT ATTENTION. Unit Attentions are created after a device reset, if the medium asynchronously becomes ready to the initiator, if another initiator changes Mode Parameters, and/or if the firmware is updated.
7h	DATA PROTECTED. The current tape medium is write-protected. This can be because the Write Protect switch on the cartridge is in its enabled position or if the tape medium is not the appropriate type (DLTtape I or DLTtape II), or if a software write protect is issued.
8h	BLANK CHECK. An End of Data or LongGap has been encountered.
Bh	COMMAND ABORTED. This key is generated when a command has been aborted by the tape drive for some reason. Check the Additional Sense Code / Additional Sense Code Qualifier bytes.
Dh	VOLUME OVERFLOW. This key indicates that the physical end of tape medium has been reached during writing. The initiator ignored the End of Medium condition and continued to write to tape.
Eh	MISCOMPARE. A compare error has occurred during READ by the self-tests invoked during execution of a SEND DIAGNOSTIC command.

Table 5–88 Supported Sense Keys

REQUEST SENSE Command (03h) (continued)

The following table provides the additional sense codes (ASCs) and additional sense code qualifiers (ASCQs) that may be reported. Additional information, explanations, or suggestions for action are included in some of the descriptions.

Sense Key	ASC	ASCQ	Meaning
00h NO SENSE	00	00	No Additional Sense Code
	00	01	Unexpected FM Encountered
	00	02	EOM Encountered
	00	04	BOM Encountered
	5D	00	Failure Prediction Threshold Exceeded
	27	82	Data Safety Write Protect
01h RECOVERED ERROR	00	17	Cleaning Requested
	0A	00	Error Log Overflow
	0A	80	Error Log Generated
	37	00	Rounded Parameter
	3B	08	Repositioning Error
	44	C1	EEROM Copy 1 Area Bad
	44	C2	EEROM Copy 2 Area Bad
	47	00	SCSI Parity Error
	48	00	IDE Message Received
	51	00	ERASE Failure
	53	01	Unload Tape Failure
	5B	01	Threshold Met
	5B	02	Log Counter at Maximum
	80	02	Cleaning Requested
80	03	Soft Error Exceeds Threshold	

*(continued)**Table 5–89 Supported ASC / ASCQ in Hex*

REQUEST SENSE Command (03h) (continued)

Sense Key	ASC	ASCQ	Meaning
02h NOT READY	04	00	Unit Not Ready, Cause Nonreportable
	04	01	Unit Not Ready, Calibration in Process
	04	02	Unit Not Ready, LOAD Command Needed
	04	03	Unit Not Ready, Manual Intervention Needed
	30	02	Incompatible Format
	30	03	Unit Not Ready, Incompatible Medium (Cleaning Cartridge) Installed
	3A	00	Medium Not Present
	3A	80	Medium Not Present, Cartridge Missing
	5A	01	Operator Media Removal Request
03h MEDIUM ERROR	00	00	Medium Error
	04	02	Unit Not Ready, LOAD Command Needed
	0C	00	WRITE Error
	11	00	Unrecovered READ Error
	11	08	Unrecovered READ Error, Incomplete Block Read
	14	00	Recorded Entity Not Found
	15	02	Position Error Detected by Read of Medium
	30	00	Cannot Read Medium
	3B	00	Sequential Positioning Error
	3B	08	Repositioning Error
	51	00	ERASE Failure
	80	00	Calibration Error
	80	01	Cleaning Required
	81	00	Directory Read Error

*(continued)**Table 5–89 Supported ASC / ASCQ in Hex (continued)*

REQUEST SENSE Command (03h) (continued)

Sense Key	ASC	ASCQ	Meaning
04h HARDWARE ERROR	08	00	LUN Communication Failure
	08	01	LUN Communication Timeout Failure
	0C	80	Write SCSI FIFO CRC Error
	11	80	Read SCSI FIFO CRC error
	11	81	Block port detected EDC error
	11	82	Block port detected record CRC error
	15	01	Random Mechanical Positioning Error
	21	01	Invalid Element Address
	3B	08	Repositioning Error
	3B	0D	Media Destination Element Full
	3B	0E	Media Source Element Empty
	40	80	Diagnostic/POST Failure, ROM EDC Error
	40	81	Diagnostic/POST Failure, RAM Failure
	40	82	Diagnostic/POST Failure, Bad Drive Status
	40	83	Diagnostic/POST Failure, Loader Diagnostics Failure
	40	84	Diagnostic/POST Failure, POST Soft Failure
	44	00	Internal Target Failure
	44	83	SCSI Chip Gross Error
	44	84	Unexplained Selection Interrupt
	44	85	Immediate Data Transfer Timeout
	44	86	Insufficient CDB Bytes
	44	87	Disconnect/SDP Sequence Failed
	44	88	Bus DMA Transfer Timeout
	44	8A	Over temperature condition
	44	C3	Both EEROM Copy areas bad
	47	00	SCSI Parity Error
	48	00	IDE Message Received

*(continued)**Table 5–89 Supported ASC / ASCQ in Hex (continued)*

REQUEST SENSE Command (03h) (continued)

Sense Key	ASC	ASCQ	Meaning
04h HARDWARE ERROR	(cont.)		
	51	00	Erase Failure
	53	00	Media Load/Eject Failure
	53	01	Unload Tape Failure
	84	01	BHC Test Failed
05h ILLEGAL REQUEST	1A	00	Parameter List Length Error
	20	00	Illegal Opcode
	21	01	Invalid Element Address
	24	00	Invalid CDB Field
	24	81	Invalid Mode on WRITE Buffer
	24	82	Media in Drive
	24	84	Insufficient Resources
	24	86	Invalid Offset
	24	87	Invalid Size
	24	89	Image Data Over Limit
	24	8B	Image/Personality is Bad
	24	8C	Not Immediate Command
	24	8D	Bad Drive/Server Image EDC
	24	8E	Invalid Personality for Code Update
	24	8F	Bad Controller Image EDC
	25	00	Illegal LUN
	26	00	Parameter List Error, Invalid Field
	26	01	Parameter List Error, Parameter Not Supported
	26	02	Parameter List Error, Parameter Value Invalid
	30	00	Incompatible medium
	39	00	Saving Parameters Not Supported

*(continued)**Table 5–89 Supported ASC / ASCQ in Hex (continued)*

REQUEST SENSE Command (03h) (continued)

Sense Key	ASC	ASCQ	Meaning
05h ILLEGAL REQUEST	(cont.)		
	3B	0D	Media Destination Element Full
	3B	0E	Media Source Element Empty
	3D	00	Invalid Bits in ID Message
	53	02	Media Removal Prevented
	82	00	Not Allowed if Not at BOT
06h UNIT ATTENTION	28	00	Not Ready To Ready Transition
	29	00	Generic Reset Occurred – Cause Undetermined
	29	01	Power On Occurred
	29	02	SCSI Bus Reset Occurred
	29	03	Bus Device Reset Occurred
	29	04	Device Internal Reset
	2A	01	Mode Parameters Changed
	2A	02	Log Parameters Changed
	3F	01	Microcode Has Been Changed
	5B	01	Log Threshold Condition Met
07h DATA PROTECTED	27	80	Hardware WRITE Protect
	27	82	Data Safety WRITE Protect
08h BLANK CHECK	00	05	EOD Encountered
09h VENDOR UNIQUE	XX *	YY *	Code Update Event

* Where XX = Drive Revision Code and YY = Controller Revision Code

(continued)

Table 5–89 Supported ASC / ASCQ in Hex (continued)

REQUEST SENSE Command (03h) (continued)

Sense Key	ASC	ASCQ	Meaning
0Bh COMMAND ABORTED	43	00	Message Error
	44	80	Unexpected Selection Interrupt
	44	82	Command Complete Sequence Failure
	44	83	SCSI Chip, Gross Error/ Illegal – Command Status
	44	84	Unexpected/Unexplained Residue Count in Transfer Register
	44	87	Disconnect Sequence Failed
	44	89	Internal Target Failure
	45	00	Select/Reselect Failure
	47	00	SCSI Parity Error
	48	00	IDE Message Error
	49	00	Invalid Message Error
	4B	00	Data Phase error
	4E	00	Overlapped Commands Attempted
	83	00	Can not retry read/write data transfer
0Dh VOLUME OVERFLOW	(No Additional Sense Code or Sense Code Qualifier)		
0Eh MISCOMPARE	(No Additional Sense Code or Sense Code Qualifier)		

Table 5–89 Supported ASC / ASCQ in Hex (continued)

Filemark, End of Medium (EOM), and Incorrect Length Indicator (ILI) Bits

Filemark (byte 2, bit 7), EOM (byte 2, bit 6), and ILI (byte 2, bit 5) are names of fields in the REQUEST SENSE command. Any of these bits may be set to a 1 even though the Additional Sense Code (ASC) / Additional Sense Code Qualifier (ASCQ) bits have a value of 0.

For example:

- Filemark, EOM, ILI bit may be set to 1 with No Sense key (00h) and ASC / ASCQ = 00 00.
- Filemark, EOM, ILI bit may be set to 1 with Recovered Error (01h) and ASC / ASCQ = 00 00.
- Filemark, BOM, ILI bit may be set to 1 with Medium Error (03h) and ASC / ASCQ = 00 00.

5.24. RESERVE UNIT (6) Command (16h)

The RESERVE UNIT (6) command is a 6-byte command that reserves the specified tape drive for exclusive use by the requesting initiator or for another specified SCSI device.

Bit Byte	7	6	5	4	3	2	1	0
0	Operation Code (16h)							
1	Logical Unit Number			3rdPty	Third Party Device ID			Rsv'd
2 - 4	Reserved							
5	Unused	Reserved				Flag	Link	

Figure 5–91 RESERVE UNIT (6) Command Descriptor Block — Data Format

RESERVE UNIT (6) Command (16h) (continued)

Field Name	Description
3rdPty	<p>The third party reservation option for RESERVE UNIT (6) allows an initiator to reserve a logical unit for another SCSI device. This option is intended for systems that use COPY, and is implemented by the tape drive.</p> <p>If set to 1, logical unit is reserved for the SCSI device whose ID appears in the Third Party Device ID field. The tape drive ignores any attempt made by any other initiator to release the reservation and returns a GOOD status.</p> <p>If set to 0, no third party reservation is requested and device is reserved for the initiator that issued the CDB.</p>
Third Party Device ID	<p>If 3rdPty is set to 1 (indicating that an initiator has reserved the logical unit for another SCSI device), this field contains the ID number of that SCSI device for which the reservation was made.</p>

Table 5–90 RESERVE UNIT (6) Command Data — Field Descriptions

A reservation via the RESERVE UNIT (6) command remains in effect until one of the following conditions is met:

- The initiator that made the reservation sends another RESERVE UNIT (6) command.
- The tape drive is released via a RELEASE UNIT (6) command from the same initiator.
- A BUS DEVICE RESET message is received from any initiator.
- A hard reset occurs.

The occurrence of the last two conditions is indicated by the drive returning a CHECK CONDITION status, sense key of UNIT ATTENTION on the next command following the condition. It is not an error to issue a RESERVE UNIT (6) command to a drive that is currently reserved by the requesting initiator.

If the logical unit has previously been reserved by another initiator, the target returns a RESERVATION CONFLICT status.

If, after honoring the reservation, any other initiator attempts to perform any command except INQUIRY, REQUEST SENSE, or RELEASE UNIT (6), the command is rejected with a RESERVATION CONFLICT status. A RELEASE UNIT (6) command issued by another initiator is ignored by that logical unit.

RESERVE UNIT (6) Command (16h) (continued)

An initiator that holds a current reservation may modify that reservation (for example, to switch third parties) by issuing another RESERVE UNIT (6) command to the tape drive.

Medium Changer Considerations for RESERVE UNIT (6) Command

The optional Element Reservation feature defined for Medium Change devices as described in the ANSI SCSI-2 specification is not supported. The RESERVE UNIT command is defined the same as for the tape drive. The whole loader unit may be reserved. This is separate from a reservation of the tape drive.

The RESERVE UNIT/ RELEASE UNIT commands operate on a LUN basis. The Medium Changer and the tape drive are generally handled as different devices. In the case of a reserved drive LUN, a MOVE MEDIUM command issued to the Medium Changer LUN cannot insert or remove a tape cartridge to or from a tape drive unless the tape drive is reserved by the same initiator.

5.25. RESERVE UNIT (10) Command (56h)

The RESERVE UNIT and the RELEASE UNIT commands are used for contention resolution in multiple-initiator systems. The RESERVE UNIT (10) command is a 10-byte command that is used to reserve a logical unit. The RESERVE UNIT (10) Command Descriptor Block is shown in Figure 5-92, and the data fields are described in Table 5-91. If RESERVE UNIT (10) is used, then RELEASE UNIT (10) is also used.

Bit Byte	7	6	5	4	3	2	1	0
0	Operation Code (56h)							
1	Reserved			3rdPty	Reserved		LongID	Extent
2	Reservation Identification							
3	Third Party Device ID							
4 - 6	Reserved							
7 - 8	(MSB) Parameter List Length (LSB)							
9	Unused		Reserved				Flag	Link

Figure 5–92 RESERVE UNIT (10) Command Descriptor Block — Data Format

RESERVE UNIT (10) Command (56h) (continued)

Field	Description
3rd Pty	When set to 1, it indicates that the Third Party Device ID field is valid.
LongID	When 0, indicates that the third party device associated with the reservation release has a number smaller than 255 and the ID value can be sent within the CDB. If set = 1, indicates that the third party device ID is greater than 255, the ID value within the CDB is ignored, and the parameter list length is at least eight.
Third Party Device ID	<p>Required and used only when the 3rdPty bit is set, in which case this field specifies the SCSI ID of the initiator to be granted the reservation of the logical unit. The drive preserves the reservation until one of the following occurs:</p> <ul style="list-style-type: none"> • It is superseded by another valid RESERVE command from the initiator; • It is released by the same initiator; • It is released by a TARGET RESET message from any initiator; • It is released by a TARGET RESET message from any initiator; or • It is released by a hard reset condition. <p>The drive ignores any attempt to release the reservation made by any other initiator. For example, if ID7 sends ID2 a Third Party reservation on behalf of ID6 (the target at ID2 gets reserved for the initiator ID6), then only ID7 can release the target at ID2 (using a Third Party release). ID6 cannot release the reservation even though the reservation was made on its behalf.</p>

*(continued)**Table 5–91 RESERVE UNIT (10) Command — Field Descriptions*

RESERVE (10) Command (56h) (continued)

Field	Description
Extent	<p>If 0, requests that the entire logical unit be reserved for use only by the initiator until the request is supplanted by another valid RESERVE command from the same initiator, or until released via a RELEASE (10) command from the reserving initiator, a hard reset, or a power on cycle.</p> <p>If set = 1, the extent reservation option is implemented. This option allows an application client in a multitasking environment to have multiple reservations.</p> <p>The size of the extent list is defined by the contents of the Parameter List Length field. The extent list consists of zero or more descriptors. Each descriptor defines an extent beginning at the specified logical block address for the specified number of blocks. If the number of blocks is 0, the extent begins at the specified logical block address and continues through the last logical block address on the logical unit. The data format of extent descriptors is shown in Figure 5-93.</p>

Table 5-91 RESERVE UNIT (10) Command — Field Descriptions (continued)

Bit	7	6	5	4	3	2	1	0
Byte								
0	Reserved					RelAdr	Reservation Type	
1 - 3	(MSB) Number of Blocks							(LSB)
4 - 7	(MSB) Logical Block Address							(LSB)

Figure 5-93 Extent Descriptors — Data Format

RESERVE UNIT (10) Command (56h) (continued)

RelAdr is always 0: The DLT8000 tape drive does not support relative addressing. The Reservation Type field defines the type of reservation in effect for the extent being reserved. Available types of reservations are shown below.

Reservation Type	Description
00b	READ shared. No write operations are permitted by any initiator to the reserved extent. Any initiator may read from the extent.
01b	WRITE exclusive. No other initiator may write to the indicated extent. Any initiator may read from the extent.
10b	READ exclusive. While this reservation is active, no other initiator may be permitted to read to the indicated extent.
11b	Exclusive access. While this reservation is active, no other initiator is permitted any access to the reserved extent.

Table 5–92 Reservation Types

If both the LongID and the Extent bits = 1, then the parameter list takes the format shown below.

Bit	7	6	5	4	3	2	1	0
Byte								
0 - 7	(MSB) Third Party Device ID							(LSB)
8 - n	(MSB) Extent Descriptors (See Figure 5-93)							(LSB)

Figure 5-94 Parameter List When LongID and Extent Bits = 1 — Data Format

RESERVE UNIT (10) Command (56h) (continued)

If the LongID bit = 1 and the Extent bit = 0, then the parameter list length is eight and the parameter list has the format shown below.

Bit	7	6	5	4	3	2	1	0
Byte								
0 - 7	(MSB)	Third Party Device ID						(LSB)

Figure 5–95 RESERVE UNIT (10) ID Only Parameter List — Data Format

5.26. REWIND Command (01h)

The REWIND command directs the tape drive to position the tape at the beginning of the currently active partition (for DLTtape drives, this is BOM). Before rewinding, the tape drive writes any write data that is in the buffer to the tape medium and appends an End of Data marker.

Bit	7	6	5	4	3	2	1	0
Byte								
0	Operation Code (01h)							
1	Logical Unit Number			Reserved				Immed
2 - 4	Reserved							
5	Unused	Reserved				Flag	Link	

Figure 5–96 REWIND Command Descriptor Block — Data Format

Field Name	Description
Immed	Immediate. If this bit is set to 1, the tape drive first writes any remaining buffered data to tape medium and adds an EOD marker. It then returns status to the host before beginning the actual rewind operation. If this bit is 0, status will be sent after the rewind has completed.

Table 5–93 REWIND Command Data — Field Descriptions

5.27. SEND DIAGNOSTIC Command (1Dh)

The SEND DIAGNOSTIC command directs the tape drive to perform its self-diagnostic tests. It can also be used to invoke the Basic Health Check (BHC) diagnostic test. Note that the BHC feature is provided for use only by a trained service provider.

Bit Byte	7	6	5	4	3	2	1	0
0	Operation Code (1Dh)							
1	Logical Unit Number			PF (0)	Rsv'd	Selfst	DevOfI	UnitOfI
2	Reserved							
3 - 4	(MSB) Reserved							(LSB)
5	Unused			Reserved			Flag	Link

Figure 5–97 SEND DIAGNOSTIC Command Descriptor Block — Data Format

Field Name	Description
PF	Page Format. Not supported; must be 0.
Selfst	Self Test. This bit is used in conjunction with DevOfI and UnitOfI to specify the type of testing to be done. An explanation is provided in the following paragraphs.
DevOfI	Device Offline. This bit is used in conjunction with Selfst and UnitOfI to specify the type of testing to be done. An explanation is provided in the following paragraphs.
UnitOfI	Unit Offline. This bit is used in conjunction with Selfst and DevOfI to specify the type of testing to be done. An explanation is provided in the following paragraphs.

Table 5–94 SEND DIAGNOSTIC Command Data — Field Descriptions

SEND DIAGNOSTIC Command (1Dh) (continued)

Two levels of unit-resident diagnostic tests can be accessed:

Electronics Self-Test (Level 1 Test)

To invoke this level of diagnostic test, a major portion of the controller hardware and software must be functioning properly. The test is based on the premise that full power-up testing is not necessary, therefore, it is an extension of the power-up self tests that are run. The code ROM EDC is verified, two queues used by much of the controller software are checked by dequeuing and enqueueing items.

If a loader (Medium Changer) is configured, the test attempts a software reset on the loader. This test does not attempt a WRITE or READ to or from the tape medium. When complete, any errors that occur are reported in the extended Sense Data bytes. This Level 1 test has an execution time of approximately five (5) seconds.

Specify the Electronics Self-Test by setting the Selfst bit to 1, and both the DevOfI and UnitOfI bits to 0.

Read / Write Functionality Test (Level 2 Test)

The default version of this test does the following:

1. Writes 500 32 KB records on track 0 (forward motion)
2. Rewinds the tape.
3. Reads the records.
4. Positions to the beginning of track 1 (backward motion)
5. Writes 500 32 KB records on track 1.
6. Repositions to the beginning of track 1.
7. Reads the records.
8. Rewinds the tape.

The execution time for this Level 2 test is approximately 6 minutes, if calibration is not required. Specify the Read/Write test by setting both the Selfst bit and the UnitOfI bit to 1 and ensuring that the DevOfI bit to 0.

A Level 3 (or test type III) is available with user defined parameters. In addition, SEND DIAGNOSTIC can be used to invoke the BHC test (Figure 5-98 and Table 5-97). Note that the BHC feature is provided for use only by a trained service provider.

SEND DIAGNOSTIC Command (1Dh) (continued)

The following table illustrates the possible settings of the Selfst, DevOfI, and UnitOfI bits and the effects of each setting on the resulting self-test:

Selfst	DevOfI	UnitOfI	Self - Test Effect
0	0	0	Illegal Combination
0	0	1	Self-Test Level 3 with User Parameters
0	1	0	Illegal Combination
0	1	1	Self-Test Level 2 with Default Parameters or BHC Test
1	0	0	Self-Test Level 1 with Default Parameters (device is on-line)
1	0	1	Self-Test Level 2 with Default Parameters (device is on-line)
1	1	0	Self-Test Level 1 with Default Parameters (device is off-line)
1	1	1	Self-Test Level 2 with Default Parameters (device is off-line)

Table 5-95 SEND DIAGNOSTIC CDB Bits Selfst, DevOfI, and UnitOfI

Bit	7	6	5	4	3	2	1	0
Byte								
0 - 1	(MSB) Pattern Number (See Table 5-96)							(LSB)
2 - 3	(MSB) Maximum Number of Test Passes							(LSB)
4 - 7	(MSB) Block Size							(LSB)
8 - 11	(MSB) Block Count							(LSB)

Figure 5-98 SEND DIAGNOSTIC Parameter List — Data Format

SEND DIAGNOSTIC Command (1Dh) (continued)

Field Name	Description																																										
Pattern Number	Indicates the type of data pattern to be used during the diagnostic test.																																										
	<table border="1"> <thead> <tr> <th>Pattern</th> <th>Name</th> <th>Data in Hex</th> </tr> </thead> <tbody> <tr> <td>0h</td> <td>Rotate</td> <td>Rotate through the other 9 patterns; change for each tape file.</td> </tr> <tr> <td>1h</td> <td>All 0s</td> <td>00 00 00 00 00</td> </tr> <tr> <td>2h</td> <td>2F</td> <td>FF FF FF FF FF</td> </tr> <tr> <td>3h</td> <td>Alternating 1s and 0s</td> <td>55 55 55 55 55 55 55 55</td> </tr> <tr> <td>4h</td> <td>Marching 1</td> <td>80 40 20 10 08 04 02 01</td> </tr> <tr> <td>5h</td> <td>Marching 0</td> <td>7F BF DF EF F7 BF FD FE</td> </tr> <tr> <td>6h</td> <td>MW</td> <td>EE EE EE EE EE EE EE EE</td> </tr> <tr> <td>7h</td> <td>MFM</td> <td>B6 DB B6 DB B6 DB B6 DB</td> </tr> <tr> <td>8h</td> <td>IF</td> <td>AA AA AA AA AA AA AA AA</td> </tr> <tr> <td>9h</td> <td>Random Data</td> <td></td> </tr> <tr> <td>2Fh</td> <td>10s</td> <td>101010</td> </tr> <tr> <td>3/4 Fh</td> <td>11s</td> <td>111111</td> </tr> <tr> <td>FFh</td> <td>Run BHC Test*</td> <td></td> </tr> </tbody> </table>	Pattern	Name	Data in Hex	0h	Rotate	Rotate through the other 9 patterns; change for each tape file.	1h	All 0s	00 00 00 00 00	2h	2F	FF FF FF FF FF	3h	Alternating 1s and 0s	55 55 55 55 55 55 55 55	4h	Marching 1	80 40 20 10 08 04 02 01	5h	Marching 0	7F BF DF EF F7 BF FD FE	6h	MW	EE EE EE EE EE EE EE EE	7h	MFM	B6 DB B6 DB B6 DB B6 DB	8h	IF	AA AA AA AA AA AA AA AA	9h	Random Data		2Fh	10s	101010	3/4 Fh	11s	111111	FFh	Run BHC Test*	
Pattern	Name	Data in Hex																																									
0h	Rotate	Rotate through the other 9 patterns; change for each tape file.																																									
1h	All 0s	00 00 00 00 00																																									
2h	2F	FF FF FF FF FF																																									
3h	Alternating 1s and 0s	55 55 55 55 55 55 55 55																																									
4h	Marching 1	80 40 20 10 08 04 02 01																																									
5h	Marching 0	7F BF DF EF F7 BF FD FE																																									
6h	MW	EE EE EE EE EE EE EE EE																																									
7h	MFM	B6 DB B6 DB B6 DB B6 DB																																									
8h	IF	AA AA AA AA AA AA AA AA																																									
9h	Random Data																																										
2Fh	10s	101010																																									
3/4 Fh	11s	111111																																									
FFh	Run BHC Test*																																										
Maximum Number of Test Passes	This field specifies the number of test passes of the diagnostic to be run. If Maximum Number of Test Passes = 0, the test will loop continuously. A BUS RESET or a selection from the host sending an ABORT or BUS DEVICE RESET message terminates testing. Note that for BHC Test*, the value in this field must be 0.																																										
Block Size	This field specifies the size of the blocks to be used. If this field is 0, random block sizes are used. Note that for BHC Test*, the value in this field must be 0.																																										

* The BHC feature is provided for use only by a trained service provider.

Table 5–96 SEND DIAGNOSTIC Parameter List — Field Descriptions

SEND DIAGNOSTIC Command (1Dh) (continued)

Field Name	Description
Block Count	<p>This field specifies how many blocks to WRITE / READ to and from starting on track 0, then moving to track 1. For example, if the Block Size and Block Count fields result in three (3) tracks worth of data, the test will:</p> <ol style="list-style-type: none"> 1. Write tracks 0, 1, 2 2. REWIND, READ, and VERIFY tracks 0, 1, 2 3. WRITE three tracks starting with 1: 1, 2, 3 and then REWIND to the beginning of track 1 and perform the READ and VERIFY pass. <p>If Block Count is = 0, data is written until EOT is reached each time, so almost four (4) complete passes over the tape would result. Note that for BHC Test*, the value of this field must be 0.</p>

* The BHC feature is provided for use only by a trained service provider.

Table 5–96 SEND DIAGNOSTIC Parameter List — Field Descriptions (continued)

NOTE

Because of data generation and verification, this test only streams the tape for short periods of time. If Block Count is set very high, therefore, the test can take many minutes or even many hours to complete

NOTE

If BHC* test runs and passes, a GOOD status is returned.

If BHC* test runs and fails, a CHECK CONDITION is generated, with a sense code containing the following:

Sense Key = 04h (Hardware Error)

ASC = 84h (BHC Result)

ASCQ = 01h (BHC Failed)

* The BHC feature is provided for use only by a trained service provider.

SEND DIAGNOSTIC Command (1Dh) (continued)

If the specified diagnostic test passes, a GOOD status is returned. Otherwise, a CHECK CONDITION is generated and the Sense Data contains information about the failure.

Sense Key	Description
3h	Medium Error. A positioning error has occurred in which the returned position does not match the expected position. Additional Sense Code for possible additional information.
4h	Hardware Error. The Additional Sense Code and any Additional Sense Code Qualifier provide more specific information.
5h	ILLEGAL REQUEST. Illegal bit settings in the SEND DIAGNOSTIC command.
Eh	Miscompare. A compare error occurred during a READ operation.

Table 5–97 Sense Keys Used for SEND DIAGNOSTIC

Additional Sense Codes and Additional Sense Code Qualifiers that apply to SEND DIAGNOSTIC self-test results are described in the table below.

Additional Sense Code	Additional Sense Code Qualifier	Description
15h	2h	A positioning error has occurred in which the returned position does not match the expected position.
40h	80h	Level 1 ROM Test Failed.
40h	81h	Level 1 RAM Test Failed.
40h	82h	Level 1 Test Failed. Bad Drive Status.
40h	83h	Level 1 Test Failed. Loader Reset Failed.
84h	01h	BHC Test Failed

Table 5–98 Additional Sense Codes and Additional Sense Code Qualifiers for SEND DIAGNOSTIC

5.28. SPACE Command (11h)

The SPACE command provides a variety of positioning functions that are determined by Code and Count fields in the Command Descriptor Block. Both forward (toward End of Medium/End of Partition) and reverse (toward Beginning of Medium/Beginning of Partition) positioning are provided. Note that the DLT8000 tape system is a single partition device.

Bit	7	6	5	4	3	2	1	0
Byte								
0	Operation Code (11h)							
1	Logical Unit Number			Reserved		Code		
2 - 4	(MSB) Count (LSB)							
5	Unused		Reserved			Flag		Link

Figure 5–99 SPACE Command Descriptor Block — Data Format

Field Name	Description										
Code	The code can be one of the following:										
	<table border="1"> <thead> <tr> <th>Space Code</th> <th>Space by:</th> </tr> </thead> <tbody> <tr> <td>000b</td> <td>Blocks</td> </tr> <tr> <td>001b</td> <td>Filemarks</td> </tr> <tr> <td>010b</td> <td>Sequential Filemarks</td> </tr> <tr> <td>011b</td> <td>End of Data</td> </tr> </tbody> </table>	Space Code	Space by:	000b	Blocks	001b	Filemarks	010b	Sequential Filemarks	011b	End of Data
Space Code	Space by:										
000b	Blocks										
001b	Filemarks										
010b	Sequential Filemarks										
011b	End of Data										
	Count values can be from 0 to FFFFFFFh.										

Table 5–99 SPACE Command Data — Field Descriptions

SPACE Command (11h) (continued)

Field Name	Description
Count	<p>When spacing over blocks or marks, the Count field is interpreted as follows:</p> <p>A positive value N causes forward motion over N blocks or marks. The tape is logically positioned after the Nth block or mark on the EOM or EOP side.</p> <p>A value of 0 causes no change in logical position.</p> <p>A negative value -N (two's complement notation) causes reverse movement over N blocks or marks. The tape is logically positioned on the BOM or BOP side of the Nth block or mark.</p> <p>When spacing to EOD, the Count field is ignored. Forward movement occurs until the drive encounters EOD. The position is such that a subsequent WRITE command would append data after the last object that has been written to tape before EOD.</p>

Table 5-99 SPACE Command Data — Field Descriptions (continued)

When executing SPACE, the tape drive implements the following hierarchy:

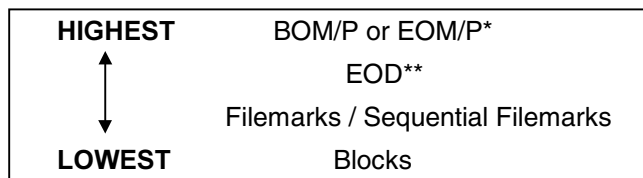

* Beginning of Media/Partition or End of Media/Partition

**End of Data

The tape drive supports only one partition.

Note that a “SPACE Sequential Filemarks” is a SPACE to the first occurrence of *n* filemarks written sequentially.

A SPACE command in the form “SPACE N blocks” will halt with GOOD status after the Nth block, or with CHECK CONDITION status on any occurrence of Filemark, EOD, BOM/P, or EOM/P. A command “SPACE N Filemarks” will halt on the Nth Filemark with GOOD status on any occurrence of EOD, BOM/P, or EOM/P.

Depending on the size of blocks, read ahead data in the buffer allows some spacing requests to be satisfied without actual tape movement.

5.29. TEST UNIT READY Command (00h)

The TEST UNIT READY command checks the tape drive to ensure that the unit is ready for commands involving tape movement. If the drive has a tape loaded, the command returns a GOOD status. Otherwise, CHECK CONDITION is reported.

Due to power cycle, code update, and tape loaded conditions, it is possible to get multiple check conditions on a TEST UNIT READY command.

Bit	7	6	5	4	3	2	1	0
Byte								
0	Operation Code (00h)							
1	Logical Unit Number			Reserved				
2 - 4	Reserved							
5	Unused		Reserved			Flag		Link

Figure 5–100 TEST UNIT READY Command Descriptor Block — Data Format

5.30. VERIFY Command (13h)

The VERIFY command directs the tape drive to verify one or more blocks beginning with the next block on the tape. Both CRC and EDCs are validated.

Bit	7	6	5	4	3	2	1	0
Byte								
0	Operation Code (13h)							
1	Logical Unit Number			Reserved		Immed	BC	Fixed
2 - 4	(MSB) Verification Length							(LSB)
5	Unused		Reserved			Flag	Link	

Figure 5–101 VERIFY Command Descriptor Block — Data Format

Field Name	Description
Immed	Immediate. When set to 1, the VERIFY command completes before any tape medium movement is done (that is, when the processing has been initiated).
BC	Byte Check. When set to 0, the tape drive performs an internal CRC/ECC check of data. No data is transferred to the initiator. When set to 1, the command is rejected.
Fixed	This bit specifies whether fixed-length or variable-length blocks are to be verified. When set to 0, variable-block mode is requested. A single block is transferred with the Verification Length specifying the maximum number of bytes the initiator has allocated for verification. When the Fixed bit is set to 1, the Verification Length specifies the number of blocks to be verified. This is valid only if the logical unit is currently operating in Fixed Block mode.
Verification Length	This field specifies the amount of data to verify, in blocks or bytes as indicated by the Fixed bit.

Table 5–100 VERIFY Command Data — Field Descriptions

5.31. WRITE Command (0Ah)

The WRITE command transfers one or more blocks from the host to the current logical position. When in Buffered Mode (see MODE SELECT), the tape drive reports GOOD status on WRITE commands as soon as this data block has been transferred to the data buffer.

Bit	7	6	5	4	3	2	1	0
Byte								
0	Operation Code (0Ah)							
1	Logical Unit Number			Reserved				Fixed
2 - 4	(MSB) Transfer Length (LSB)							
5	Unused		Reserved				Flag	Link

Figure 5–102 WRITE Command Descriptor Block — Data Format

WRITE Command (0Ah) (continued)

Field Name	Description
Fixed	<p>The fixed bit specifies both the meaning of the Transfer Length field and whether fixed-length or variable-length blocks are to be transferred.</p> <p>When the Fixed bit is 0, Variable-length block mode is selected. A single block is transferred from the initiator and is written to the logical unit beginning at the current logical tape position. Upon successful termination, the tape is logically positioned after this block (on the End of Media/Partition, or EOM/P side). The Transfer Length specifies the number of bytes that the drive handshakes out from the initiator as one block.</p> <p>When the Fixed bit is 1, the Transfer Length field specifies the number of blocks to be transferred to the host beginning at the current tape position. This form of WRITE is valid only if the logical unit is currently operating in the Fixed Block mode – when it has been instructed to use fixed-length blocks with MODE SELECT. The current block length is the block length defined in the MODE SELECT command. Upon termination, the tape is logically positioned after these blocks.</p>
Transfer Length	<p>This field contains the length of the data transfer in bytes or blocks depending on whether Fixed or Variable block mode is selected.</p> <p>When the Transfer Length is 0, no data is transferred and the current position on the logical unit is not changed.</p>

*Table 5–101 WRITE Command Data — Field Descriptions***Exception Conditions**

If End of Tape (EOT) is detected while writing, the tape drive finishes writing any buffered data. The command terminates with CHECK CONDITION status. Within the sense data, the EOM bit is set, the Sense Key is set to NO SENSE, and the Additional Sense code and Additional Sense Code Qualifier fields are set to EOM/P detected. The drive attempts to complete any subsequent writes, returning a CHECK CONDITION status in each case.

WRITE Command (0Ah) (continued)

If the tape drive encounters the physical End of Medium (EOM) when attempting WRITE, a CHECK CONDITION status is returned. Within the sense data, the EOM and Valid bits are set, and the Sense Key field is set to Volume Overflow. The Information fields contain the residue count and the Additional Sense code and Additional Sense Code Qualifier fields are set to EOM/P Detected. The tape is physically positioned at EOM/P.

5.32. WRITE BUFFER Command (3Bh)

The WRITE BUFFER command is used with READ BUFFER as a diagnostic function for testing the device data buffer, DMA engine, SCSI bus interface hardware, and SCSI bus integrity. It is also used for downloading and updating DLTtape microcode (firmware).

Bit	7	6	5	4	3	2	1	0
Byte								
0	Operation Code (3Bh)							
1	Logical Unit Number			Reserved		Mode		
2	Buffer ID (00h)							
3 – 5	(MSB)	Buffer Offset						(LSB)
6 – 8	(MSB)	Parameter List / Data Length						(LSB)
9	Unused		Reserved			Flag		Link

Figure 5–103 WRITE BUFFER Command Descriptor Block — Data Format

Field Name	Description										
Mode	The tape drive supports the following values within the field. If any other value is set, the drive terminates the command with CHECK CONDITION status and an ILLEGAL REQUEST sense key set.										
	<table border="1"> <thead> <tr> <th>Mode</th> <th>Description</th> </tr> </thead> <tbody> <tr> <td>000b</td> <td>WRITE combined header and data (Section 5.32.1)</td> </tr> <tr> <td>010b</td> <td>WRITE data (Section 5.32.2)</td> </tr> <tr> <td>100b</td> <td>Download Microcode (Section 5.32.3)</td> </tr> <tr> <td>101b</td> <td>Download Microcode and Save (Section 5.32.4)</td> </tr> </tbody> </table>	Mode	Description	000b	WRITE combined header and data (Section 5.32.1)	010b	WRITE data (Section 5.32.2)	100b	Download Microcode (Section 5.32.3)	101b	Download Microcode and Save (Section 5.32.4)
Mode	Description										
000b	WRITE combined header and data (Section 5.32.1)										
010b	WRITE data (Section 5.32.2)										
100b	Download Microcode (Section 5.32.3)										
101b	Download Microcode and Save (Section 5.32.4)										

Table 5–102 WRITE BUFFER Command Data — Field Descriptions

WRITE BUFFER Command (3Bh) (continued)

Field Name	Description
Buffer ID	For all of the modes described for the Mode field, only a Buffer ID of 0 is supported. If the Buffer ID field is a value other than 0, the command is rejected. The target detects and rejects commands that would overrun the buffer.
Buffer Offset	See Sections 5.32.1 through 5.32.4 for the appropriate settings.

*Table 5–102 WRITE BUFFER Command Data — Field Descriptions (continued)***5.32.1 Write Combined Header and Data Mode (000b)**

The data to be transferred is preceded by a 4-byte header consisting entirely of reserved bytes. This header is discarded (not stored within the buffer).

The buffer offset field must be 0 for this mode.

5.32.2 Write Data Mode (010b)

Similar to Header and Data Mode, except there is no header in the data passed to the target. Any potential buffer overruns are detected and the command is rejected.

CAUTION

During the actual reprogramming of the FLASH EEPROM, if any type of powerfail occurs, or if the reprogramming fails before completion, the tape drive subsystem becomes unusable and the tape drive must be replaced.

5.32.3 Download Microcode Mode (100b)

Using buffer offsets, the host can download the firmware image into the target's buffer in pieces. These commands do not cause the new image to become active. A Download and Save Mode WRITE BUFFER command must be issued for the image to become active.

WRITE BUFFER Command (3Bh) (continued)

The tape drive must be empty of tape medium to allow downloading of an image. This is a safeguard against accidentally starting a firmware update. If a tape cartridge is loaded when all or part of a firmware image has been downloaded, another WRITE BUFFER with Download Microcode mode will be rejected. The firmware image must be downloaded in integral multiples of 8K bytes.

Any error on a WRITE BUFFER command causes any downloaded image data to be discarded and the download must be restarted from the beginning.

CAUTION

During the actual reprogramming of the FLASH EEPROM, if any type of powerfail occurs, or if the reprogramming fails before completion, the tape drive subsystem becomes unusable and the tape drive must be replaced.

5.32.4. Download Microcode and Save Mode (101b)

This mode is used to download and save the entire image at once, or to download the image and save it, or to cause a save operation after the image data has been downloaded using the Download Microcode mode (without the Save). This mode of the WRITE BUFFER command causes the image data to be verified and the Flash EEPROM firmware area to be updated. During the reprogramming of the Flash EEPROM, the WRITE PROTECT and Drive Activity leds on the drive's front panel blinks. Also, when it is updating the EEPROM, it disconnects from the SCSI bus and will not respond until the update is complete.

When the Save operation is successfully completed, the firmware restarts itself, causing the Power On Self Test (POST) to be run, and two UNIT ATTENTION conditions are generated: POWER UP RESET and OPERATING CODE HAS CHANGED.

5.33. WRITE FILEMARKS Command (10h)

The WRITE FILEMARKS command directs the tape drive to write the specified number of Filemarks beginning at the current logical position on tape. If the Immediate bit is not set, any data or Filemarks in the WRITE cache buffer are written to tape.

Bit	7	6	5	4	3	2	1	0
Byte								
0	Operation Code (10h)							
1	Logical Unit Number			Reserved			WSMk (0)	Immed
2 - 4	(MSB) Number of Filemarks (LSB)							
5	Unused		Reserved			Flag		Link

Figure 5–104 WRITE FILEMARKS Command Descriptor Block — Data Format

WRITE FILEMARKS Command (10h) (continued)

Field Name	Description
WSmk	Write Setmark. Must be 0. This tape drive does not support Setmarks.
Immed	Immediate. When this bit is set to 1, the tape drive returns status as soon as the Command Descriptor Block (CDB) has been validated, unless the Filemark count is 0, or greater than 1 (since either condition causes the WRITE buffer to be flushed to tape medium). When set to 0, this bit indicates the status will not be returned until the operation is complete.
Number of Filemarks	This field contains the number of consecutive Filemarks to be written to tape medium. A value of 0 is not considered to be an error; GOOD status is returned.

Table 5-103 WRITE FILEMARKS Command Data — Field Descriptions

The WRITE FILEMARKS command may be used to force the tape drive to write any buffered WRITE data to the tape medium. If the tape drive is in buffered mode, and WRITE FILEMARKS is received, the requested filemarks are appended to the data and the WRITE buffer contents are flushed to tape medium. A value of 0 in the Number of Filemarks field indicates that no filemarks are to be written to the tape medium, but still flushes any WRITE data to the tape medium.

If End of Tape (EOT) is detected while writing filemarks, the tape drive finishes writing any buffered data and terminates with CHECK CONDITION status. Within the Sense data, the End of Medium (EOM) bit is set, the Sense Key field is set to NO SENSE and the Additional Sense Code and Additional Sense Code Qualifier fields are set to EOM/P DETECTED. The tape drive attempts to complete any subsequent WRITE FILEMARKS, returning a CHECK CONDITION status in each case. If the tape drive encounters the physical EOM when attempting a WRITE FILEMARKS, it returns CHECK CONDITION status.

A. Definition of Vendor Unique Sense Data Information

This appendix lists the internal status codes with their descriptions.

The internal status code is located at byte offset 18 of the REQUEST SENSE data and may be available for certain types of failures.

NOTE

Byte 18 of the REQUEST SENSE data has two formats: a byte code and a bit flags format. The bit flags format is used when there is no internal status code to report and can be quickly distinguished by checking to see if bit 7 of byte 18 is set to 1.

Decimal	Hexadecimal	Description
0	0	No Meaning
1	1	Reed-Solomon Error Correction Code Recovery
2	2	READ or WRITE Block Retry (Soft Retry)
3	3	REPOSITION Command Aborted
4	4	Controller Has Stopped Reading
5	5	No Control or Data Buffers Available
6	6	Target Delivered in Read Ahead
7	7	Logical EOT Encountered, 2 Filemarks
8	8	Command Connection Dropped
9	9	Cleared from Queue
10	0A	Missing Data Block – READ only
11	0B	Gap Within Object (Missing Block in Record)
12	0C	Record on Tape Larger Than Requested
13	0D	Compare Error

Table A-1 Internal Status Codes

Decimal	Hexadecimal	Description
14	0E	Successive Blocks Missing Across Objects
15	0F	Drive State Not Valid for Command
16	10	Drive Error
17	11	Drive Communication Timeout Error
18	12	Drive Unloaded
19	13	Unable to WRITE – No CRC
20	14	Block to Append To Not Found
21	15	Data Synchronization Error (READ after WRITE Not Happening)
22	16	Missing Block(s) in Current Entity
23	17	Drive Hardware WRITE Protected
24	18	Reposition-Target Not Found
25	19	Log Gap Encountered (Blank Tape or No Data Encountered)
26	1A	End of Data or Filler Block Encountered
27	1B	Filemark Encountered
28	1C	EDC Error Found by “FEZ” ASIC – FECC RAM Bad
29	1D	Beginning of Medium Encountered
30	1E	EDC Error
31	1F	Hard WRITE Error – “FEZ” ASIC Underrun
32	20	Hard WRITE Error – READ Sync Timeout
33	21	Hard WRITE Error – Overshoot Append
34	22	Hard WRITE Error – CRC Error
35	23	EDC Error Found by “FEZ” ASIC – FECC RAM OK
36	24	Timeout on Command to Medium Changer
37	25	Medium Changer UART Error (Overrun)
38	26	Medium Changer Response Length Error
39	27	Medium Changer Detected Error
40	28	Invalid Source Slot

Table A-1 Internal Status Codes (continued)

Decimal	Hexadecimal	Description
41	29	Invalid Destination Slot
42	2A	Source Slot Empty
43	2B	Destination Slot Full
44	2C	Medium Changer Motion Error
45	2D	Medium Changer/Drive Interface Error
46	2E	Medium Changer/Slot Interface Error
47	2F	Medium Changer Mechanical Error
48	30	Medium Changer Hardware Error
49	31	Medium Changer Controller Error
50	32	Unrecognized Medium Changer Subcommand
51	33	Medium Changer Fatal Error
52	34	Medium Changer is in Manual Mode
53	35	68020 Detected Communication Error with Servo Area
54	36	68020 Detected Drive Command Timeout
55	37	Calibration Failure
56	38	Bad Tape Format

Table A-1 Internal Status Codes (continued)

Bit 7	Bit 6 (Rsv'd)	Bit 5 (Rsv'd)	Bit 4 (Rsv'd)	Bit 3 (Rsv'd)	Bit 2	Bit 1	Bit 0																											
<table border="1"> <thead> <tr> <th>Bit No.</th> <th>Description</th> </tr> </thead> <tbody> <tr> <td>0</td> <td>If set to 1, Cleaning Light is Illuminated, otherwise Light is off.</td> </tr> <tr> <td>2 & 1</td> <td>Tape Directory Status Bits:</td> </tr> <tr> <td></td> <td> <table border="1"> <thead> <tr> <th>Bit 2</th> <th>Bit 1</th> <th>Description</th> </tr> </thead> <tbody> <tr> <td>0</td> <td>0</td> <td>Good Status</td> </tr> <tr> <td>0</td> <td>1</td> <td>Unknown Status</td> </tr> <tr> <td>1</td> <td>0</td> <td>Partial Directory (will be rebuilt when tape is undergoing READ/WRITE)</td> </tr> <tr> <td>1</td> <td>1</td> <td>No Directory (will be rebuilt when tape is undergoing READ/WRITE)</td> </tr> </tbody> </table> </td> </tr> <tr> <td>3 - 6</td> <td>Reserved</td> </tr> <tr> <td>7</td> <td>If set to 1, the Internal Status Byte (Byte 18) is in Bit Flags format; otherwise Byte 18 contains a status code.</td> </tr> </tbody> </table>								Bit No.	Description	0	If set to 1, Cleaning Light is Illuminated, otherwise Light is off.	2 & 1	Tape Directory Status Bits:		<table border="1"> <thead> <tr> <th>Bit 2</th> <th>Bit 1</th> <th>Description</th> </tr> </thead> <tbody> <tr> <td>0</td> <td>0</td> <td>Good Status</td> </tr> <tr> <td>0</td> <td>1</td> <td>Unknown Status</td> </tr> <tr> <td>1</td> <td>0</td> <td>Partial Directory (will be rebuilt when tape is undergoing READ/WRITE)</td> </tr> <tr> <td>1</td> <td>1</td> <td>No Directory (will be rebuilt when tape is undergoing READ/WRITE)</td> </tr> </tbody> </table>	Bit 2	Bit 1	Description	0	0	Good Status	0	1	Unknown Status	1	0	Partial Directory (will be rebuilt when tape is undergoing READ/WRITE)	1	1	No Directory (will be rebuilt when tape is undergoing READ/WRITE)	3 - 6	Reserved	7	If set to 1, the Internal Status Byte (Byte 18) is in Bit Flags format; otherwise Byte 18 contains a status code.
Bit No.	Description																																	
0	If set to 1, Cleaning Light is Illuminated, otherwise Light is off.																																	
2 & 1	Tape Directory Status Bits:																																	
	<table border="1"> <thead> <tr> <th>Bit 2</th> <th>Bit 1</th> <th>Description</th> </tr> </thead> <tbody> <tr> <td>0</td> <td>0</td> <td>Good Status</td> </tr> <tr> <td>0</td> <td>1</td> <td>Unknown Status</td> </tr> <tr> <td>1</td> <td>0</td> <td>Partial Directory (will be rebuilt when tape is undergoing READ/WRITE)</td> </tr> <tr> <td>1</td> <td>1</td> <td>No Directory (will be rebuilt when tape is undergoing READ/WRITE)</td> </tr> </tbody> </table>	Bit 2	Bit 1	Description	0	0	Good Status	0	1	Unknown Status	1	0	Partial Directory (will be rebuilt when tape is undergoing READ/WRITE)	1	1	No Directory (will be rebuilt when tape is undergoing READ/WRITE)																		
Bit 2	Bit 1	Description																																
0	0	Good Status																																
0	1	Unknown Status																																
1	0	Partial Directory (will be rebuilt when tape is undergoing READ/WRITE)																																
1	1	No Directory (will be rebuilt when tape is undergoing READ/WRITE)																																
3 - 6	Reserved																																	
7	If set to 1, the Internal Status Byte (Byte 18) is in Bit Flags format; otherwise Byte 18 contains a status code.																																	

Table A-2 Internal Status Bit Flags

B. EEPROM-resident Bugcheck and Event Logs

This appendix provides a explanation of the event logs (information packets) stored in semi-permanent, non-volatile memory of the tape drive. These packets can be retrieved via the SCSI LOG SENSE command with Page Code 07h.

B.1 . EEPROM Packets (LAST n EVENTS)

The tape drive keeps certain event logs in semi-permanent, non-volatile memory (EEPROM, in this case) located on the tape drive's controller PCB. There is storage enough within EEPROM for a total of 14 of these logs, or packets, each packet consisting of 98 bytes (96 data bytes plus two control bytes) of information. Packets may be written for different reasons and several packet types exist.

The information in the event logs does not indicate that a tape drive or tape medium has failed but is useful in isolating problems that may be occurring.

The logs are maintained in a circular buffer: a new entry overwrites the oldest existing entry. At any point in time, the most recent 14 logs are kept.

The EEPROM information packets can be retrieved via the SCSI-2's LOG SENSE command with Page Code 07 (Last n Error Events Page).

The packet type field defines the content as well as the format of the data portion of the packet. These packet types are detailed in this Appendix. Note that the byte offsets in the structure layout diagrams are reference relative tot he beginning of the 98-byte EEPROM log envelope.

B.2. Bugcheck Packets

Bugchecks are the result of some firmware-detected errors. For example, a hardware failure or an internal system consistency failure may cause a bugcheck. These events cause bugcheck packets to be written to EEPROM.

The most important information within the packet is the error code. The more common bugcheck codes are listed in Table B—1. A full listing of all possible codes is not provided: they are typically associated with firmware or product development and are not expected once the product is released. Analysis of the other information saved within an EEPROM bugcheck packet requires the in-depth firmware knowledge to interpret and/or attempt to determine the actual cause.

Error Code	Meaning and Possible Cause
E204h	Unexpected Timer 2 Interrupt – Possible Tape Drive Controller PCB fault
EE01h	Spurious Non-Maskable Interrupt – Possible Tape Drive Controller PCB fault
EE02h	Spurious 8524 Timer Interrupt – Possible Tape Drive Controller PCB fault
EE03h	Spurious Level 5 Interrupt (GPSP) – Possible Tape Drive Controller PCB fault
EE04h	Spurious Drive Comm Interrupt – Possible Tape Drive Controller PCB fault
EE05h	Spurious Loader Comm Interrupt – Possible Tape Drive Controller PCB fault
EE06h	Spurious Diag Comm Interrupt – Possible Tape Drive Controller PCB fault
EE08h	Watch Dog Expiration – SCSI bus may have lost termination, or Tape Drive Controller PCB is constantly receiving non-tape commands.
EE09h	Spurious Power Fail Signal Received – Possible Power Supply fault.
EE0Dh	Spurious Level 6 Interrupt (GPSP) – Possible Tape Drive Controller PCB fault
F202h	Loader Time-Out – Possible Media Loader fault

Table B–1 Bugcheck Packet Error Codes (Bytes 9 – 10)

B.2.1. POST Failure Packets

POST failure packets are stored whenever the Power On Self Test logic detects a failure of any kind. Each failure is encoded as a 4-byte vector. In some cases, multiple vectors may be stored.

If logging of POST failures occurs, contact a service representative.

B.2.2. Event Log Packets

Event log packets are non-fatal and can occur to log information about significant events. Refer to Table B—2 for a listing of the existing error codes that are found within event log packets.

Note: These logs are informational only

Error Code	Meaning
0xA400	Hard READ Error Log
0xA401	Hard WRITE Error Log
0xA402	Drive Error Log
0xA403	Loader Error Log
0xA404	Calibration Log1 Error Entry
0xA405	Calibration Log2 Error Entry
0xA406	EDC Error Detected by SCSI Port Code
0xA407	Directory Read Fail *
0xA408	Directory Write Fail *
0xA409	Unload Information Statistics
0xA40B	Media Quality Log
0xA40C	Spurious Eject
0x40D	Directory Write on Unload Retries Failed *
0x40E	Directory Write after Read Retries Failed *
0x40F	Directory Read Retries Failure *

* Directory Read and Write Fail recoverable events are discussed below.

Table B–2 Event Log Error Codes (Bytes 9 – 10)

Directory Failure Event Log Packets

Directory failure event logs are written when a directory read or directory write request fails for any reason. Table B—3 provides the description of important fields within the packet. Note that the byte count begins at Byte 13, the location of the 1st event log byte within the event log packet.

Field	Description																		
Saved Overwrites / Rereads / Rewrites	These fields serve as temporary counters and have no use in interpreting the directory failure packets.																		
Directory Called Mode	A code that specifies the original reason for the directory call. A value of 1 indicates a directory READ (on LOAD). A value of 2 indicates a directory WRITE (on UNLOAD). A value of 3 indicates a directory WRITE (on WRITE from BOT).																		
Tape Format Called / New	These fields contain the TMSCP values for the tape format both prior to and after the directory operation.																		
Flags	A bit-mapped field that provides additional status information.																		
	<table border="1"> <thead> <tr> <th>Bit Mask</th> <th>Meaning</th> </tr> </thead> <tbody> <tr> <td>0x01h</td> <td>READ on LOAD operation complete</td> </tr> <tr> <td></td> <td>Inhibit further WRITE operations unless WRITE from BOT</td> </tr> <tr> <td></td> <td>LBN 0 was found intact</td> </tr> <tr> <td></td> <td>Directory WRITE failed</td> </tr> <tr> <td></td> <td>Tape format mismatch</td> </tr> <tr> <td></td> <td>Event log generated</td> </tr> <tr> <td></td> <td>Tape format unknown</td> </tr> <tr> <td></td> <td>Reserved</td> </tr> </tbody> </table>	Bit Mask	Meaning	0x01h	READ on LOAD operation complete		Inhibit further WRITE operations unless WRITE from BOT		LBN 0 was found intact		Directory WRITE failed		Tape format mismatch		Event log generated		Tape format unknown		Reserved
Bit Mask	Meaning																		
0x01h	READ on LOAD operation complete																		
	Inhibit further WRITE operations unless WRITE from BOT																		
	LBN 0 was found intact																		
	Directory WRITE failed																		
	Tape format mismatch																		
	Event log generated																		
	Tape format unknown																		
	Reserved																		

Table B-3 Directory Failure Event Package – Field Descriptions

C. Updating the Firmware

This chapter explains how to update the tape system's PCBA-resident firmware.

C.1. Overview

Using the tape drive's front panel and a tape with the updated firmware image, you can update the tape drive's PCBA-resident firmware.

CAUTION

If a powerfail occurs during the firmware update process (when the new image is actually being programmed into the FLASH EEPROMs), the tape drive's PCBA will be rendered unusable. When performing a firmware update, take all possible precautions to prevent power failure to the tape drive.

C.2. Creating a Firmware Update Tape

To update the tape drive's PCBA firmware, you need a tape cartridge with a copy of the new firmware image. The firmware image must be byte-written without compression onto the tape using the appropriate block size as defined in Table C—1. The image must be “copied” onto the tape instead of using the backup utility.

Tape Format	Density	Upgrade Tape Block
DLTtape III	10.0 GB	4 Kbytes Only
DLTtape IIIXT	15.0 GB	4 Kbytes Only
DLTtape IV	20.0 GB	4 Kbytes Only
	35.0 GB	8 Kbytes Only
	40.0 GB	8 Kbytes Only

Table C—1 Block Size Used for Firmware Update Tape

NOTE

On UN*X systems, use the FTP utility to transfer the binary firmware image. Be sure to specify “type image” before using the “get” or “put” commands, otherwise extra characters may be added to the file, causing it to be invalid. The image file should be exactly 1286 * 512 bytes in size.

When making the update tape, copy the image file to the tape media using an appropriate block size as shown in Table D-1, that is, dd, ltf, and so on. The tape must be uncompressed.

C.3. Firmware Update Procedure

This section describes the procedure to update the firmware of the tape drive's PCBA. The update requires a cartridge that holds the update firmware image. Firmware updates from a host are also supported (see the section on the SCSI command WRITE BUFFER in Chapter 5).

CAUTION

If a powerfail occurs during the firmware update process (when the new image is actually being programmed into the FLASH EEPROMs), the tape drive's PCBA will be rendered unusable. When performing a firmware update, take all possible precautions to prevent power failure to the tape drive.

Make sure you are using a DLTtape that bears the firmware image of the required revision level copied to it.

1. Put the tape drive into the firmware update mode. To do this
 - A. Remove any cartridge in the target tape drive and close the handle (down position).
 - B. Press the UNLOAD button on the drive front panel and hold the button until the WRITE PROTECTED indicator begins blinking (approximately six seconds). This indicates that the tape drive has recognized your request for firmware update mode and is waiting for the sequence to complete.

NOTE

If the WRITE PROTECTED indicator does not blink, check that:

1. POST passed
2. The drive is unloaded.
3. The drive handle is in its down position.

- C. Release the UNLOAD button, then press the UNLOAD button again within four (4) seconds. The second press should take less than one (1) second.
- D. The TAPE IN USE and the WRITE PROTECTED indicators will blink. This indicates that the tape drive recognizes that the firmware update mode has been selected.

If you are unsuccessful in selecting the firmware update mode (if, for example, pressing the UNLOAD button the second time requires longer than one [1] second), the WRITE PROTECTED indicator will stop blinking within several seconds. Try the procedure again. If the drive and controller PCBA are not communicating properly, you cannot select the firmware update function.

Once the firmware update mode has been successfully selected, insert the cartridge with updated firmware image into the drive. The drive then

- Automatically reads the cartridge. The tape will move for a few minutes performing calibration and directory processing before any data is read.
- Examines the data
- Verifies that the data is a valid firmware image for the tape drive.

At this point, the firmware update mode is automatically cleared. One of the following conditions will occur:

- If the firmware image is valid and the drive code is up-to-date, the drive code does not go through an update.
- If the firmware image is valid and the drive code is NOT up-to-date, the code in the drive is updated. This will take 2 - 3 minutes

While the drive code is being updated, the WRITE PROTECTED and TAPE IN USE indicators flash alternately.

When the drive code update is complete, the drive resets, and runs its Power-On Self Test (POST). The process waits until the tape is reloaded at the beginning of tape (BOT).

If the firmware image is valid, the tape drive's PCBA controller's FLASH EEPROM is updated with the new firmware image. The WRITE PROTECTED and TAPE IN USE indicators flash again during the controller firmware update.

C.4. Interpreting the Results of a Firmware Update

Following a firmware update procedure, two possible results can occur:

- The firmware update cartridge is unloaded. This signals a successful update

The tape drive rewinds the cartridge, the door is unlocked, and the green OPERATE HANDLE indicator illuminates.

- The firmware update cartridge is NOT unloaded. This signals an unsuccessful update.

The tape drive subsystem may still be usable. Failure may be a result of:

- Power failure
- Bad firmware image on the tape
- Non-functioning FLASH EEPROMS.

Table C—2 provides troubleshooting information.

If...	Then.....
The image is valid	<ol style="list-style-type: none"> <li data-bbox="603 1060 1127 1118">1. The FLASH EEPROM containing the current firmware is erased. <li data-bbox="603 1135 1127 1419">2. The new image is programmed into FLASH EEPROM (approximately 2 minutes). Then: <ul style="list-style-type: none"> <li data-bbox="652 1211 929 1236">• The tape drive resets <li data-bbox="652 1253 981 1278">• The tape drive runs POST <li data-bbox="652 1295 1127 1419">• The tape drive unloads the tape cartridge and the cartridge can be removed. This indicates a successful firmware update.

Table C—2 Results of Firmware Update

If...	Then.....
<ol style="list-style-type: none"> 1. The tape is NOT a valid firmware update tape 2. The tape does not contain a valid firmware image 	<p>No firmware update is attempted. The WRITE PROTECTED and TAPE IN USE indicators do not blink. The drive resets and the tape remains loaded to signal that the firmware update was unsuccessful.</p>
<p>The tape contains a valid image but there is a failure when attempting to reprogram FLASH EEPROM</p>	<p>The controller PCBA is probably unusable and should be replaced. The tape drive performs a reset and reruns POST. POST will fail if FLASH EEPROM does not contain a valid firmware image.</p>

Table C—2 Results of Firmware Update (continued)

This Page Intentionally Left Blank

D. Running the Basic Health Check (BHC) Test via the Library Port

This appendix explains how to run the DLT8000 tape system's BHC test on a tape drive that is configured as a component within a library.

NOTE:

The BHC feature is provided for use only by a trained service provider.

Issue the RUN BHC TEST command (15h) to the tape drive configured within the library.

For the results of the BHC test, obtain Tape Data Packet 3 by issuing a SEND TAPE DATA 3 command (13h). The results of the BHC test are reported in Byte 1 of Tape Data Packet 3.

The BHC test status results possible are:

Code	Indicates...	Meaning...
00h	BHC Test Not Run	BHC test has not been invoked via the Library Port since the last time that Tape Data Packet 3 was read. The tape drive within the library sets this status <u>after</u> each read of the Tape Data Packet 3 except if the BHC test is in progress.
01h	BHC Test In Progress	This code indicates that the BHC test was invoked via the Library Port and is currently in progress.
02h	BHC Test Pass	BHC test has completed successfully; no trouble found.
03h	BHC Test Fails	BHC test has failed.
04h	Diagnostic Test in Progress	This code indicates that a diagnostic test was in progress when the library controller attempted to invoke the BHC test. This prevents the BHC test from running.

This Page Intentionally Left Blank

E. Visual Inspection Procedure for DLTtape Cartridges

This appendix explains how to visually inspect a DLTtape Cartridge. Damaged cartridges must not be used.

DLTtape CARTRIDGE GENERAL HANDLING GUIDELINES

- Always keep each tape cartridge in its protective plastic case when it is not in the tape drive.
- When carrying tape cartridges in their cases, always orient the cases so that the grooves in the cases interlock. This prevents the cases from slipping apart and falling.
- Never stack the tape cartridges in a stack of more than five.
- Always observe the proper environmental conditions for the storage of tape cartridges. Refer to the cartridge reference card supplied with each cartridge.
- When placing tape cartridges in archival storage, make sure you stand each tape cartridge vertically.
- Avoid placing tape cartridge near any sources of high intensity magnetic fields, such as monitor or electric motors.
- Never apply adhesive labels or POST-IT notes on the top, side, or bottom of your DLTtape cartridge. Only use the user slide- in type label provided with each cartridge and slide it over the label slot on the cartridge.
- Do not carry cartridges loosely in a box or any other container. Allowing cartridges to hit together exposes the them to unnecessary physical shock.
- **Do not touch or allow direct contact with tape or tape leader.** Dust or natural skin oils can contaminate the tape and impact tape performance.
- Do not expose the tape cartridge to moisture or direct sunlight.
- Do not insert any cartridge that has been dropped into the DLTtape drive without at least a thorough visual inspection as described in this paper. A dropped cartridge may have dislodged, loosened, or damaged internal components.

VISUAL MECHANICAL INSPECTION PROCEDURE

When should you perform a visual mechanical inspection (VMI) on a DLTtape cartridge?

You should do a VMI

- As a general practice whenever you change or load a new tape cartridge
- If a tape cartridge is dropped or subject to some hard physical shock
- If the DLTtape drive becomes inoperable after loading a tape cartridge
- If you receive a shipment of tape cartridges that show any sign of shipping damage

Follow these steps to visually inspect a DLTtape cartridge:

1. Remove the tape cartridge from its protective plastic case.
2. Look at the tape cartridge to check for any obvious cracks or other physical damage. Look for broken or missing parts.
3. Gently shake the tape cartridge. Listen for any rattling or sounds of any loose pieces inside the cartridge. *If you hear anything loose inside, do not use the cartridge.*
4. Hold the tape cartridge so that the end of the cartridge that is inserted into the DLTtape drive is facing you, as shown in Figure E-1. You will see that there is a small opening on the left-hand side of the tape cartridge.

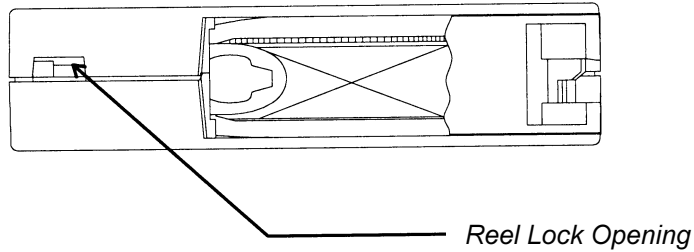

*Figure E-1 Location of One of the Two Reel Lock Tabs
on the DLTtape Cartridge*

Inside and near the center of this opening, you should see a small plastic tab. This is one of the reel locks. The reel locks can break if the cartridge is dropped. This may be the cause of any rattling sound you hear when you gently shake the tape cartridge. *If this reel lock tab is not visible do not use the cartridge.*

5. Look at the bottom of the tape cartridge, holding it as shown in Figure E-2.

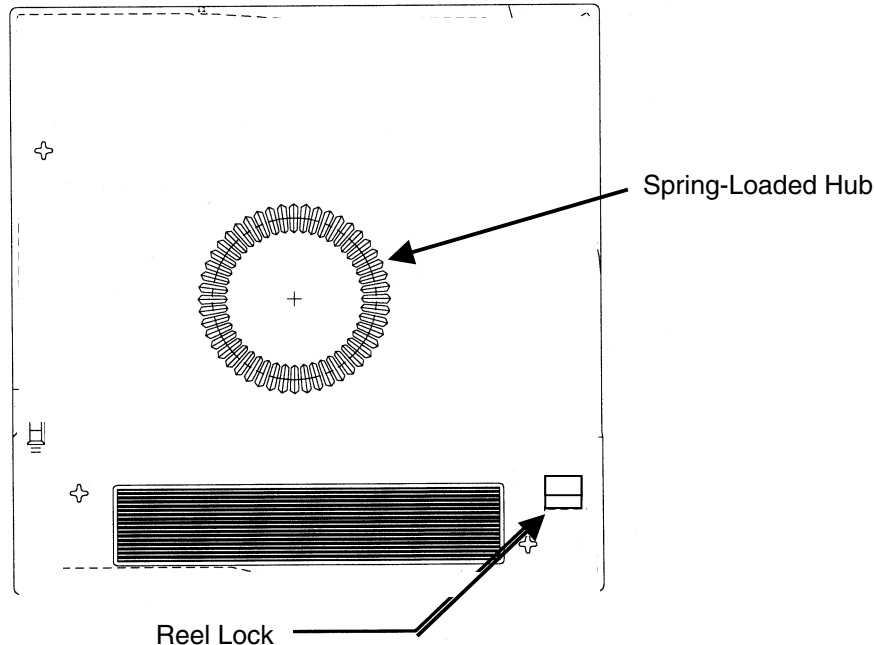

Figure E-2 Location of Reel Lock Opening and Spring-Loaded Hub on Bottom of DLTtape Cartridge

Check the opening indicated in Figure E-2 and ensure that the small plastic tab is partially visible. This is the second reel lock. The reel locks can break if the cartridge is dropped. This may be the cause of any rattling sound you hear when you gently shake the tape cartridge. *If this reel lock tab is not visible do not use the cartridge.*

Also located on the bottom of the tape cartridge is the spring-loaded hub. Verify that the hub is centered within the circular opening in the tape cartridge. Gently press the hub and make sure that it springs back into place. Make sure that it ends up centered within its circular opening.

6. Ensure that the tape leader within the tape cartridge is in the correct position. To do this, you must open the tape cartridge door. Refer to Figure E-3.

Leader Loop

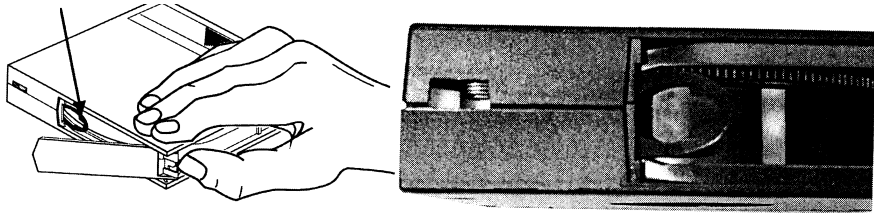

Figure E-3 Opening the Door on a DLTtape Cartridge Showing Tape Leader Loop in its Correct Position

Open the door by holding the DLTtape cartridge as shown in Figure E-3.

On the right side corner of the tape cartridge there is a small tab in a cut-out portion of the cartridge. Using your thumb, gently lift up on the tab and swing the door open (Figure E-3).

Inside the door, you will see the tape and cartridge leader loop. The loop should stick up about an eighth of an inch when viewed from the edge; the loop must be a closed loop. *If the loop is torn, bent, pulled in, or not sticking up about an eighth of an inch, do not use the tape cartridge.*

7. Figure 4 shows three different tape cartridge loop problems. *No tape cartridge that exhibits the problems shown in the examples in Figure E-4 should be used in a DLT tape system.*

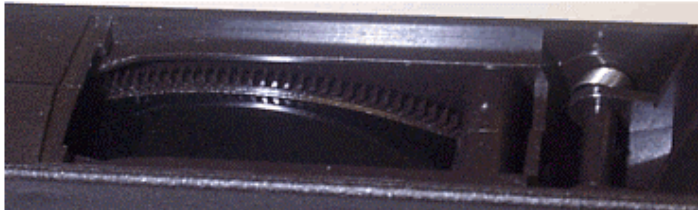

Example 1:
"Swallowed" Tape Cartridge Leader

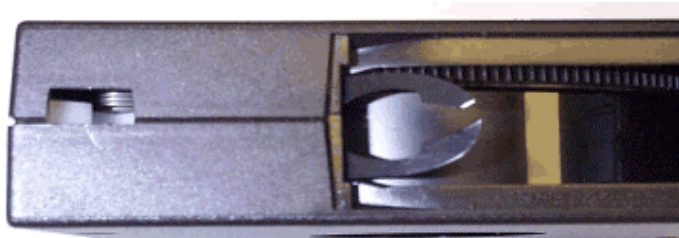

Example 2:
Torn or Broken Leader Loop

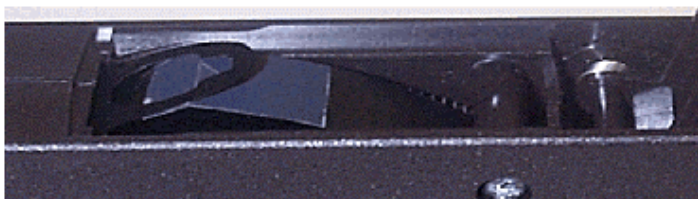

Example 3:
Tape is Loosely Wound

Figure E-4 Three Examples of Tape Cartridges with Damage Visible During Visual Inspection

8. Finally, check for proper operation of the tape cartridge's Write Protect Switch (Figure E-5). This sliding switch, located on the end of the tape cartridge used for the tape label, should snap smartly back and forth, and the orange tab should be visible when the tape cartridge is set to provide Write Protection (data on the tape cannot be written over).

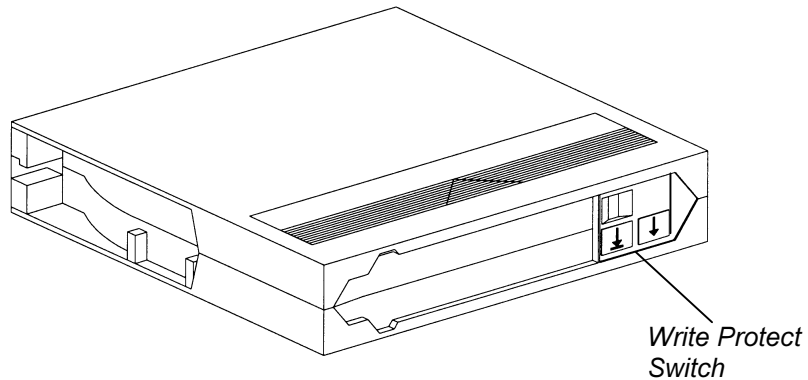

Figure E-5 Location of Write Protect Switch

This Page Intentionally Left Blank

F. Timeout Specifications for DLT8000 Tape System SCSI Commands

This appendix provides the timeout specifications for the SCSI commands supported by the DLT8000 tape system.

Command	Timeout
ERASE	6 hours (for overwriting the entire tape)
INQUIRY	500 milliseconds
LOAD / UNLOAD	16 minutes
LOCATE	6 hours
LOG SELECT	500 milliseconds
LOG SENSE	500 milliseconds
MODE SELECT	500 milliseconds
MODE SENSE	500 milliseconds
PERSISTENT RESERVATION IN	500 milliseconds
PERSISTENT RESERVATION OUT	500 milliseconds
PREVENT / ALLOW MEDIA REMOVAL	500 milliseconds
READ	1 hour
READ BLOCK LIMITS	500 milliseconds
READ BUFFER	3 minutes
READ POSITION	500 milliseconds
RECEIVE DIAGNOSTICS	500 milliseconds
RELEASE UNIT	500 milliseconds
REPORT DENSITY SUPPORT	500 milliseconds
REPORT LUNS	500 milliseconds
REQUEST SENSE	500 milliseconds
RESERVE UNIT	500 milliseconds
REWIND	4 minutes
SEND DIAGNOSTICS	20 minutes
SPACE	6 hours (Directory may need rebuilding)
TEST UNIT READY	500 milliseconds
VERIFY	1 hour
WRITE	1 hour
WRITE BUFFER (Update FLASH)	10 minutes
WRITE FILEMARK	1 hour

This Page Intentionally Left Blank

G. DLT7000 Emulation Feature

This appendix provides information about using the DLT7000 emulation feature on a DLT8000 tape drive. It includes information about what the feature is, compares the feature with actual DLT7000 tape drive capability, and explains how to enable the emulation feature.

DLT7000 emulation is a feature that has been included in the DLT8000 tape drive's firmware. It allows a host to operate a DLT8000 tape drive with this emulation feature enabled to function as a DLT7000 tape drive, emulating the DLT7000 tape drive's performance, capacity, and SCSI bus communication. Note, however, that some minor differences will exist so that emulation of a DLT7000 drive is not exact; those differences will be described in this Appendix.

When in DLT7000 emulation mode, the DLT8000 tape drive identifies itself over the SCSI bus as a DLT7000 tape drive, even though it will still support the additional SCSI-3 commands not supported by a genuine DLT7000 drive. This will not present a problem, though, since those commands should not be invoked in a DLT7000 drive's environment anyway. Running in DLT7000 emulation mode, a DLT8000 drive will have a capacity of 35 GB (native) and a transfer rate of 5 MB/second.

Applications will be able to distinguish between a DLT7000 drive and a DLT8000 drive in DLT7000 emulation mode over the SCSI Bus via the "Product Family" code returned in the SCSI INQUIRY command's Vendor Unique Bytes. Once enabled, the DLT7000 emulation setting will be retained even across power cycles in the tape drive.

G.1. Enabling and Clearing the DLT7000 Emulation Feature

CAUTION

Use Extreme Caution when enabling the DLT7000 emulation feature: the DLT7000 emulation mode changes the operation of the tape drive and fundamentally changes the way data and media are handled.

- Do NOT enable/clear the DLT7000 emulation feature with a tape cartridge loaded in the tape drive.
 - Do NOT enable/clear the DLT7000 emulation feature while the drive is in operation.
1. Enable and clear the DLT7000 emulation mode via the SCSI bus by changing the EMUL7K_MODE parameter (in EEPROM) on the Vendor Unique EEPROM Parameter Page.
 - When EMUL7K_MODE is set to **1**, DLT7000 emulation is enabled on the drive.
 - When EMUL7K_MODE set to **0**, it restores the drive to standard DLT8000 operation.
 2. After the DLT7000 Emulation Mode feature has been enabled, it is critical that you reinitialize the SCSI bus interface using one of the following methods:
 - Issue a bus reset (this resets all devices on the bus);
 - Issue the Advanced SCSI Programming Interface (ASPI, an interface specification for sending commands to SCSI host adapters) Device Reset command **SCSI_RESET_DEV** (this resets the specific device changed); or
 - Issue the ASPI command **SRB COMMANDRESCANBUS**, as described in the Win 32 ASPI Specification.

G.2. What You Should Know About the DLT7000 Emulation Feature

A DLT8000 tape system running with DLT7000 emulation enabled does not “become” a DLT7000 system, nor does it retain all of the features of a DLT8000 system. Here are the differences:

1. A DLT8000 tape drive with DLT7000 emulation enabled has the capability of writing and reading 10 GB, 15 GB, 20 GB and 35 GB formats. It will not support the 2.6 GB and 6.0 GB formats supported by a “real” DLT7000 system, however. The DLT8000 system hardware cannot support these formats.
2. On a READ operation, a DLT8000 system with DLT7000 emulation enabled will reject any tape written in 40 GB format, reporting a Medium Error with no illumination of the cleaning light. Writing from Beginning of Tape (BOT) is allowed, with 35 GB format as default.
3. Selection of 40 GB format from the front panel, the library port, or the SCSI bus interface is disabled by the DLT7000 emulation feature.
4. By design, DLT8000 tape drives do not include an audio indicator (“beep”) as a signal for tape unloading. Running the drive with DLT7000 emulation enabled will not provide an audio indicator.
5. There are differences in the Power On Self Test (POST) for a DLT7000 and a DLT8000 with DLT7000 emulation enabled. DLT7000 drives run a minimized POST due to the amount of available memory within the drives. DLT8000 drives, even with DLT7000 emulation enabled, have sufficient memory available to run the full POST image.

G.3. Verifying Product Family via the SCSI Bus

You can verify a DLTtape system's product family via the SCSI Bus. The following table describes the information returned by the SCSI command INQUIRY. The contents of the Product Family bits (byte 4, bits 4 – 7) of the INQUIRY command's Subsystem Components Revision Page (C1h). A DLT8000 running with DLT7000 emulation enabled will return a Product Family code of 09h.

Product	Product ID*	Product Family
DLT7000	"DLT7000"	7
DLT8000	"DLT8000"	8
DLT8000 with DLT7000 Emulation Enabled	"DLT7000"	9

*The product ID is dependent on the Firmware Personality.

Note that the Product ID of a DLT8000 system running with DLT7000 emulation enabled is reported as a DLT7000. The Product Family code, however, is reported as 9, indicating that emulation is enabled.

G.4. SCSI Bus Differences

The table below illustrates the SCSI bus differences between a DLT7000 system, a DLT8000 system, and a DLT8000 system with DLT7000 emulation enabled.

SCSI opcodes that exist for a DLT7000 drive will have an identical response on a DLT8000 drive with emulation enabled. Note that SCSI opcodes that are not compatible with a “real” DLT7000 drive *are* supported by a DLT8000 drive in DLT7000 emulation mode.

	DLT7000 Drive	DLT8000 Drive	DLT8000 Drive with DLT7000 Emulation Enabled
REPORT DENSITY Command	Not supported	Supported	Supported (only reports supported formats)
REPORT LUNS Command	Not supported	Supported	Supported
PERSISTENT RESERVE IN Command	Not supported	Supported	Supported
PERSISTENT RESERVE OUT Command	Not supported	Supported	Supported
INQUIRY Command			
▪ CmdDTbit	Not supported	Supported	Supported
INQUIRY Data			
▪ Product Identification	“DLT7000” (Personality dependent)	“DLT8000” (Personality dependent)	“DLT7000” (Personality dependent)
▪ Product Family	7 (35.0/70.0 GB)	8 (40.0/80.0 GB)	9 (35.0/70.0 GB)
INQUIRY Vital Product Data Page 83H			
▪ IEEE Identifier	Not supported	Supported	Supported

(continued)

	DLT7000 Drive	DLT8000 Drive	DLT8000 Drive with DLT7000 Emulation Enabled
MODE SELECT Command			
<ul style="list-style-type: none"> Density Code Field 			
0x00 Default	<i>DLT7000 - Supported</i>	DLT8000 - Supported	<i>DLT7000 - Supported</i>
0x17 2.6 GB	Supported	Not Supported	Not Supported
0x18 6.0 GB	Supported	Not Supported	Not Supported
0x19 10/15GB	Supported	Supported	Supported
0x1A 20GB	Supported	Supported	Supported
0x1B 35GB	Supported	Supported	Supported
0x41 40GB	Not Supported	Supported	Not Supported
0x80 10/15GB no compress	Supported	Supported	Supported
0x81 20/30GB compress *	Supported	Supported	Supported
0x82 20GB no compress	Supported	Supported	Supported
0x83 40GB compress *	Supported	Supported	Supported
0x84 35GB no compress	Supported	Supported	Supported
0x85 70GB compress *	Supported	Supported	Supported
0x88 40GB no compress	Not Supported	Supported	Not Supported
0x89 80GB compress*	Not Supported	Supported	Not Supported
* assuming 2:1 compression			
MODE SELECT Command			
<ul style="list-style-type: none"> Speed Field 			
	Allows only 0 to be selected	Allows 0,1,2,3 to be selected	Allows only 0 to be selected
MODE SELECT/SENSE Commands			
<ul style="list-style-type: none"> EEPROM Vendor-Unique Page (3Eh) 			
	Supported	Supported	Supported (EEPROM parameters may be different)
LOG SENSE Command			
<ul style="list-style-type: none"> Last n Events Log Page (07h) 			
	DLT7000 Format Support	DLT8000 Format Support	DLT8000 Format Support
<ul style="list-style-type: none"> Device Status Page (3Eh) Drive Temp. Parameter 			
	Not supported	Supported	Supported

(continued)

	DLT7000 Drive	DLT8000 Drive	DLT8000 Drive with DLT7000 Emulation Enabled
Page C1h			
• Vendor Unique	DLT7000 Format Support	DLT8000 Format Support	DLT8000 Format Support (Product Family 0x09)
READ POSITION			
Command			
• Long Format Bit	Not supported	Supported	Supported
SEND DIAGNOSTIC			
Command			
• Run Basic Health Check (BHC) Pattern Number	Not supported	Supported	Supported
Detailed Unit Attention ASCQs for Resets	Not supported	Supported	Supported

G.5. Front Panel Differences

The table below describes the difference between the front panels of a “real” DLT7000 drive, a DLT8000 drive, and a DLT8000 drive with DLT7000 emulation enabled.

	DLT7000 Drive	DLT8000 Drive	DLT8000 with DLT7000 Emulation Enabled
Density Select			
40GB	Not supported	Supported	Not supported
35GB	Supported	Supported	Supported
20GB	Supported	Supported	Supported
10/15GB	Supported	Supported	Supported
6.0GB	Supported	Selection Not Available	Selection Not Available
2.6GB	Supported	Selection Not Available	Selection Not Available
Run BHC Test	Not supported	Supported	Supported

NOTE

DLT8000 Front Panel

The 40/80 GB density light and selection are not available when a DLT8000 drive is running in DLT7000 emulation mode. The 40/80 GB density selection is skipped in the selection sequence.

This Page Intentionally Left Blank

TANDBERG DATA 

www.tandberg.com

Part No. 42 22 54-01
Publ. NO. 9158-1
January 2001