

answers²

Technisches Handbuch / Technical Manual

Mainboard D1522 / D1521

Deutsch / English / Français



Sie haben ...

... technische Fragen oder Probleme?

Wenden Sie sich bitte an:

- Ihren zuständigen Vertriebspartner
- Ihre Verkaufsstelle

Aktuelle Informationen und Updates (z. B. BIOS-Update) zu unseren Mainboards finden Sie im Internet: <http://www.fujitsu-siemens.com/mainboards>

Are there ...

... any technical problems or other questions you need clarified?

Please contact:

- your sales partner
- your sales outlet

The latest information and updates (e.g. BIOS update) on our mainboards can be found on the Internet under: <http://www.fujitsu-siemens.com/mainboards>

Dieses Handbuch wurde auf Recycling-Papier gedruckt.
This manual has been printed on recycled paper.
Ce manuel est imprimé sur du papier recyclé.
Este manual ha sido impreso sobre papel reciclado.
Questo manuale è stato stampato su carta da riciclaggio.
Denna handbok är tryckt på recyclingpapper.
Dit handboek werd op recycling-papier gedrukt.

Herausgegeben von/Published by
Fujitsu Siemens Computers GmbH

Bestell-Nr./Order No.: **A26361-D1522-Z120-1-6319**
Printed in the Federal Republic of Germany
AG 0103 01/03



A26361-D1522-Z120-1-6319

Mainboard D1522 / D1521

**Technisches Handbuch
Technical Manual**

**Ausgabe Januar 2003
January 2003 edition**

Deutsch

English

Français



Intel, Pentium und Celeron sind eingetragene Warenzeichen der Intel Corporation, USA.

Microsoft, MS, MS-DOS und Windows sind eingetragene Warenzeichen der Microsoft Corporation.

PS/2 und OS/2 Warp sind eingetragene Warenzeichen von International Business Machines, Inc.

Alle weiteren genannten Warenzeichen sind Warenzeichen oder eingetragene Warenzeichen der jeweiligen Inhaber und werden als geschützt anerkannt.

Alle Rechte vorbehalten, insbesondere (auch auszugsweise) die der Übersetzung, des Nachdrucks, der Wiedergabe durch Kopieren oder ähnliche Verfahren.

Zu widerhandlungen verpflichten zu Schadenersatz.

Alle Rechte vorbehalten, insbesondere für den Fall der Patenterteilung oder GM-Eintragung.

Liefermöglichkeiten und technische Änderungen vorbehalten.

Dieses Handbuch wurde erstellt von
cognitas. Gesellschaft für Technik-Dokumentation mbH
www.cognitas.de

Copyright © Fujitsu Siemens Computers GmbH 2003

Intel, Pentium and Celeron are registered trademarks of Intel Corporation, USA.

Microsoft, MS, MS-DOS and Windows are registered trademarks of Microsoft Corporation.

PS/2 and OS/2 Warp are registered trademarks of International Business Machines, Inc.

All other trademarks referenced are trademarks or registered trademarks of their respective owners, whose protected rights are acknowledged.

All rights, including rights of translation, reproduction by printing, copying or similar methods, even of parts are reserved.

Offenders will be liable for damages.

All rights, including rights created by patent grant or registration of a utility model or design, are reserved. Delivery subject to availability.

Right of technical modification reserved.

This manual was produced by
cognitas. Gesellschaft für Technik-Dokumentation mbH
www.cognitas.de

Übersicht/Overview Mainboard D1522 / D1521

Interne Anschlüsse und Steckplätze / Internal connectors and slots

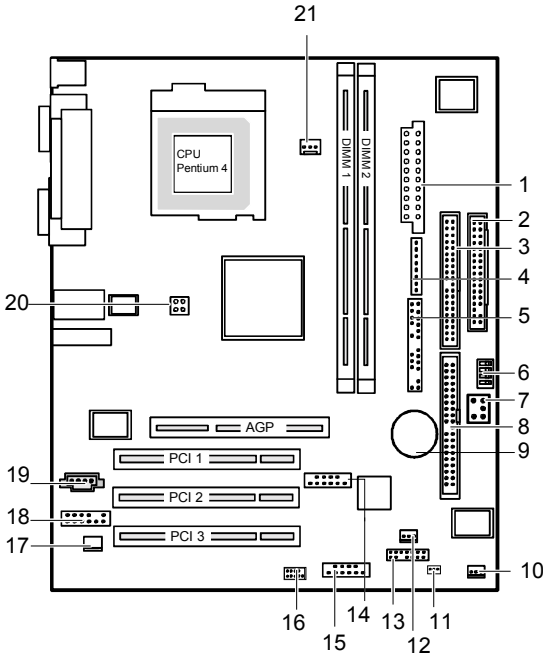

- 1 = Stromversorgung / Power Supply
- 2 = Diskettenlaufwerk / Floppy disk drive
- 3 = IDE-Laufwerke 3/4 / IDE-drives 3/4
- 4 = Stromversorgungsüberwachung / Power supply monitoring
- 5 = Bedienfeld / Front panel
- 6 = Schalter / Switch
- 7 = Steckbrücken / Jumper
- 8 = IDE-Laufwerke 1/2 / IDE-drives 1/2
- 9 = Batterie / Battery
- 10 = Lüfter 2 / Fan 2
- 11 = Power On LED II
- 12 = Gehäuseüberwachung / Intrusion
- 13 = LCD-Statusanzeige / LCD status indicator
- 14 = USB C/D
- 15 = USB E/F
- 16 = Serielle Schnittstelle 2 / serial interface 2
- 17 = S/PDIF Anschluss / S/PDIF connector
- 18 = Audio-Bedienfeld / Audio front panel
- 19 = CD-Audio in
- 20 = Stromversorgung Prozessor / Processor power supply
- 21 = Lüfter 1 / Fan 1

Optionale Komponenten / Optional components

Externe Anschlüsse / External connectors

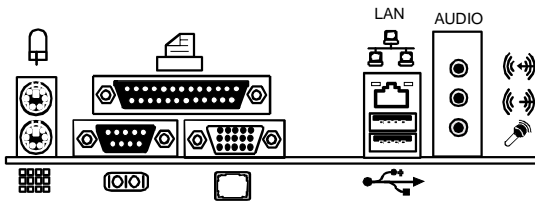

Bedienfeld / Front panel

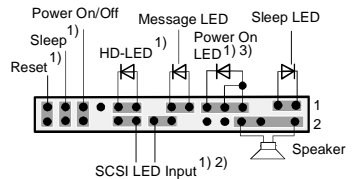

- 1) Cable is not included in the delivery scope.
- 2) The same interface
- 3) 2pin or 3pin connector possible

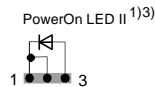

Contents

Mainboard D1522 / D1521	1
Notational conventions	1
Important notes.....	2
Information about boards	2
List of features.....	3
Special technical features – special features	4
Brief instructions on installing mainboard	6
Prior to installation	6
Interfaces and connectors	8
External ports	8
Internal ports and connectors	9
Hard disk connection	9
Pin assignment of internal ports.....	10
Settings with switches and jumpers	15
Add-on modules / Upgrading	16
Installing and removing processors.....	16
Installing the processor with heat sink and fan.....	16
Upgrading main memory.....	18
Upgrading AGP screen controllers.....	19
Adding PCI cards.....	19
PCI bus interrupts - Selecting correct PCI slot	20
Replacing lithium battery.....	21
BIOS update.....	22
BIOS Recovery - Recovering System BIOS	23
Microcode Update	23
Drivers	24
Annex	25
Electrical Properties.....	25
Loadability for connections and fuses	25
Mainboard current requirement.....	25
APM and ACPI system status, energy-saving modes	26
Mainboard Revision and BIOS Version.....	27
Error messages	28
DOS error messages	31
SmartCard reader - error messages	32
Glossary	33

Mainboard D1522 / D1521

Your mainboard is available in different configuration levels. Depending on the configuration chosen, some of the hardware components described may not be available on your mainboard.

Further information

Information on the *BIOS Setup* and additional descriptions of the drivers are contained:

- in the readme files on your hard disk
- on the driver floppy disks included
- on the CD "Drivers & Utilities Collection" or "Drivers & Utilities" or "ServerStart".



The programme *Acrobat Reader* must be installed to be able to open the manuals. You may find the programme on the CD-ROM directory: `utls/acrobat`.

For more details please read the according `readme.txt` files.

Notational conventions

The meanings of the symbols and fonts used in this manual are as follows:



indicates information which is important for your health or for preventing physical damage.



indicates additional information which is required to use the system properly.

► Text which follows this symbol describes activities that must be performed in the order shown.

␣ This symbol indicates that you must enter a blank space (press the Space Bar) at this point.

↵ This symbol indicates that you must press the Enter key.

`Text in this typeface` indicates screen outputs.

Text in this bold typeface indicates the entries you make via the keyboard.

Text in italics indicates commands or menu items.

"Quotation marks" indicate names of chapters or terms.

Important notes

With the mainboard installed you must open the system to access the mainboard. How to dismantle and reassemble the system is described in the operating manual accompanying the system.

Connecting cables for peripherals must be adequately shielded to avoid interference.



Observe the safety notes in the operating manual of your system.

Incorrect replacement of the lithium battery may lead to a risk of explosion. It is therefore essential to observe the instructions in the "Add-on modules / Upgrading" - "Replacing lithium battery" section.

Components can become very hot during operation. Ensure you do not touch components when making extensions to the mainboard. There is a danger of burns!



The shipped version of this board complies with the requirements of the EEC directive 89/336/EEC "Electromagnetic compatibility".

Compliance was tested in a typical PC configuration.

When installing the board, refer to the specific installation information in the manual for the receiving device.



The warranty is invalidated if the system is damaged during the installation or replacement of expansions. Information on which expansions you can use is available from your sales outlet or the customer service centre.

Information about boards

To prevent damage to the mainboard, the components and conductors on it, please take great care when you insert or remove boards. Take great care to ensure that extension boards are slotted in straight, without damaging components or conductors on the mainboard, or any other components, for example EMI spring contacts.

Remove the plug from the mains outlet so that system and mainboard are totally disconnected from the mains voltage.

Be careful with the locking mechanisms (catches, centring pins etc.) when you replace the mainboard or components on it, for example memory modules or processors.

Never use sharp objects (screwdrivers) for leverage.



Boards with electrostatic sensitive devices (ESD) are identifiable by the label shown.

When you handle boards fitted with ESDs, you must, under all circumstances, observe the following:

- You must always discharge static build up (e.g. by touching a grounded object) before working.
- The equipment and tools you use must be free of static charges.
- Remove the power plug from the mains supply before inserting or removing boards containing ESDs.
- Always hold boards with ESDs by their edges.
- Never touch pins or conductors on boards fitted with ESDs.

List of features

Onboard features	D1522-A	D1521-A
Chipset	i845GE	i845GE
Board size	μ-ATX	μ-ATX
VGA	✓	✓
Audio	✓	✓
Buzzer / int. Speaker Support	- / ✓	- / ✓
LAN / with Alert-on-LAN	✓ / ✓	✓ / -
HI-SPEED USB 2.0	✓	✓
SmartCard Reader Support (USB / serial)	✓ / -	- / -
Temperature monitoring	✓	-
System Monitoring	✓	-
Fujitsu Siemens Computers Keyboard Power Button Support	✓	✓

Internal ports

DIMM Sockets (DDR SDRAM, PC2100/1600)	2	2
AGP Slot (2/4x, 32 bit, 66 MHz, 1.5 V)	1	1
PCI slot (32 bit, 33 MHz, 5 V and 3.3 V)	3	3
CNR Slot (Type A, AC'97 only)	-	-
IDE Interface (Ultra DMA/100)	2	2
Floppy Interface (up to 2.88 MB)	1	1
S/PDIF* (digital audio)	1	1
CD / AUX audio input	1 / -	1 / -
Frontpanel Audio (headphone, microphone)	1	1
Wake On LAN	-	-
USB Ports* (2.0, ~480 Mb/s)	4	4
Serial Ports* (FIFO, 16550 compatible)	1	1
Fan Connectors PSU** / FAN1 / FAN2 / FAN3	1 / 1 / 1 / -	- / 1 / 1 / -
SMBus Connector* (Case Temperature)	1	-
Intrusion Connector* (Case Open)	1	-
Power Connectors ATX / ATX12V / AGP PRO	1 / 1 / -	1 / 1 / -

External ports

VGA	1	1
Audio Mic. in / Line in / Line out (2 x 0,5 W / 8 Ω)	1 / 1 / 1	1 / 1 / 1
Game/MIDI	-	-
LAN (RJ-45)	1	1
PS/2 mouse/keyboard	1 / 1	1 / 1
USB Ports (2.0, ~480 Mb/s)	2	2
Serial Ports (FIFO, 16550 compatible)	1	1
Parallel Port (EPP/ECP)	1	1

* for use with internal devices or optional Front or Rear panel

** not supported by standard power supplies

Special technical features – special features

Your mainboard is available in different configuration levels. Depending on the configuration, your mainboards is equipped with or supports the features described in the following.

Thermal Management and System Monitoring



A microcontroller developed by Fujitsu Siemens Computers reliably protects your PC against damage caused by overheating. Overheating can lead to the data loss or processor damage. An ingenious fan control and monitoring system prevents unnecessary noise. Should the processor nevertheless become too hot at the maximum fan speed, then the processor clock rate will automatically be reduced so that the system continues to run stably. In addition, the microcontroller offers monitoring of, for example, system voltages (12 V, 5 V, CMOS), opening of the case and a watchdog function.

The microcontroller operates independently of the operating system and the processor. All values are displayed with *DeskView*, *DeskViewOEM* or *SystemGuard*.

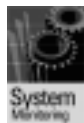

You can reduce the noise resulting when the hard disk is accessed to a barely perceptible level. The resulting power decrease is approx. 10-20% depending on the hard disk.

A password assignment for the hard disk is only possible with suitable, newer hard disks and prevents unauthorised access to the stored data.



Silent Mode and *Harddisk Password* are activated in the *BIOS Setup*. Additional information is contained in the "BIOS Setup" manual.



Logo Boot



A customer-specific logo can be displayed during system booting. The logo is loaded using the *LogoFlash* tool. The logo can have a size of 640 x 480 pixels with 16 colours. The tool is provided on the CD "Drivers & Utilities" or "Drivers & Utilities enhanced" or is available on the Internet at <http://www.fujitsu-siemens.com/mainboards>.

DeskView / DeskViewOEM



The network-capable manageability software *DeskView/DeskViewOEM** mainly consists of three modules:

- *DeskInfo* shows the most important device data of the PCs in a network (local and/or on an administrator PC).
- *DeskAlert* monitors the operability of all major components and triggers alarms if necessary depending on the mainboard variant.
- *DeskFlash* carries out a BIOS update under Windows.

Recovery BIOS



If an error occurs during a BIOS update (e.g. due to a power failure), the system BIOS will be destroyed. All Fujitsu Siemens Computers mainboards are equipped with a recovery BIOS. With it a destroyed BIOS can easily be restored. Exact instructions are provided in the chapter "BIOS Recovery - Recovering System BIOS".

IA-PC



Instantly Available PC ensures fast availability of the PC from an energy-saving mode. Within just a few seconds the PC is in exactly the same state it was in when it was switched off without time-consuming booting. Depending on the operating system, the PC can be switched into an energy-saving mode with applications open by pressing the ON/OFF switch.

Brief instructions on installing mainboard

If you have purchased a separate mainboard, you can install the mainboard in your system in accordance with the following brief instructions.

The activities described here assume a basic knowledge of PCs and cannot be carried out by a layperson. If you are not sure whether you have the necessary specialised knowledge, then leave this work to an expert.

The illustrations of the system show examples of possible cases.

Prior to installation

- ▶ Please take note of the safety information in the "Important notes" chapter.
- ▶ Check whether the processor, memory modules and power supply are suitable for this mainboard:
 - (see "Installing and removing processors" chapter).
 - (see "Upgrading main memory" chapter).
 - (see "Electrical Properties" chapter).
- ▶ Make sure the current requirement of the fans (processor, case) does not exceed the loadability of the fan connections (see chapter entitled "Electrical Properties").
- ▶ First only install the components absolutely necessary (graphics card, processor and heat sink, one memory module) and only connect the required connections (power supply unit, case connections such as ATX on/off switch, hard disk or floppy disk drive). You should not install additional cards and devices until this minimum configuration successfully boots (see chapter entitled "Add-on modules / Upgrading").

Installation

- ▶ Equip the mainboard with the processor, heat sink and memory modules before installation if possible. Further information can be found in "Installing and removing processors" chapter.

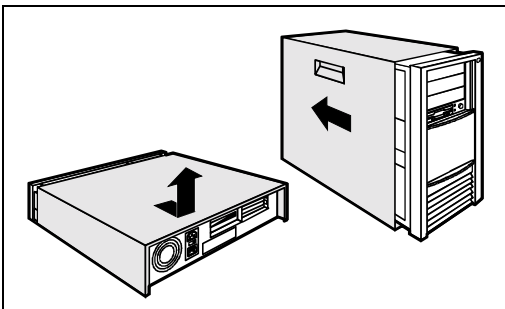

- ▶ Open the casing as described in the operating manual.

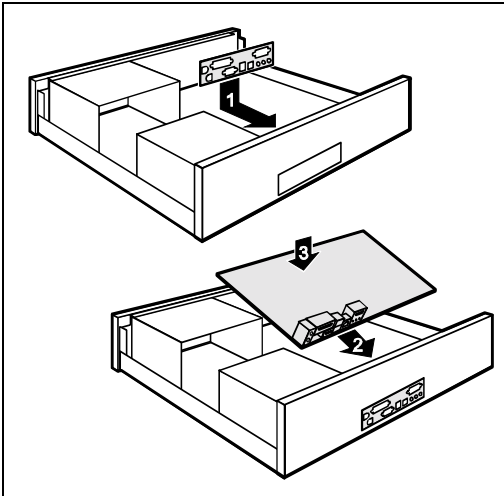

- ▶ Should no suitable connection field be provided in the case, then you must install the connection field (1) provided.

Ensure the plate is aligned properly so that the connections are suitable for the mainboard later.

- ▶ Set the mainboard on the edge on which the connection field is located (2) and then insert the board in the case (3).

Make sure that spacers in the housing are only mounted at points at which there are mounting holes in the mainboard.

- ▶ Fasten the mainboard with the screws.

- ▶ Connect the plugs for the power supply, control panel and drives to the corresponding connections on the mainboard.

Driver installation

- ▶ Install the drivers for the chipset. You may find the driver on the "Drivers & Utilities" CD. Please refer to chapter "Drivers" for a description of installing drivers.











Interfaces and connectors

The positions of the interfaces and connectors are shown on page "Cover".

The components and connectors marked are not necessarily present on the mainboard.

External ports

The positions of the external ports are shown on page "Cover".

	PS/2 keyboard port, purple		PS/2 mouse port, green
	Serial interface, turquoise		Parallel port/Printer, burgundy
	LAN connector		USB - Universal Serial Bus, black
	Audio output (Line out), light green		Microphone jack (mono), pink
	Audio input (Line in), light blue		VGA port, blue (monitor)

LAN connector

This mainboard is equipped with the 82562ET (D1521) or the 82562EM (D1522) LAN controller. Both LAN controller support transfer speeds of 10 Mbit/s and 100 Mbit/s. The LAN controller are equipped with a 3 KB transmission and receiving buffer (FIFO) and support WOL function through Magic Packet™.

It is also possible to boot a device without its own boot hard disk via LAN. Here bootix® LAN BootP or bootix® PXE are supported.

The LAN RJ45 connector has two LEDs (light emitting diodes).

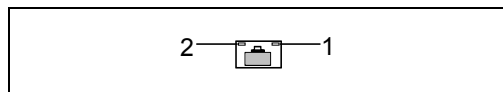

- 1 = a connection exists (e.g. to a hub).
- 2 = Link Mode: the LAN connection is active.
WOL mode: a Magic Packet™ is being received.

Graphics port - Supported screen resolutions

Depending on the operating system used, the screen resolutions in the following table refer to the mainboard screen controller.

If you are using an external screen controller, you will find details of supported screen resolutions in the operating manual or technical manual supplied with the controller.

Screen resolution	Refresh rate (Hz)	bpp	Colour
640 x 480	120	32	32 bit
800 x 600	120	32	32 bit
1024 x 768	100	32	32 bit
1280 x 1024	100	32	32 bit
1600 x 1200	100	32	16 bit
1920 x 1440	75	32	16 bit
2048 x 1536	60	32	16 bit

Internal ports and connectors

The positions of the internal ports and connectors are shown on the Cover. Additional information on some ports is also provided here.

Hard disk connection

An ultra ATA/66 or ultra ATA/100 hard disk must be connected with a cable especially designed for the ultra ATA/66 or ultra ATA/100 mode.

- ▶ Connect the end of the cable marked with blue to the mainboard.

Pin assignment of internal ports

The pin assignment of some internal connections is shown in English in the following.



Some of the following connectors may be optional!

Front panel

Watch the poling of the LEDs. The positive pole of the connection cables is often indicated with a coloured wire.

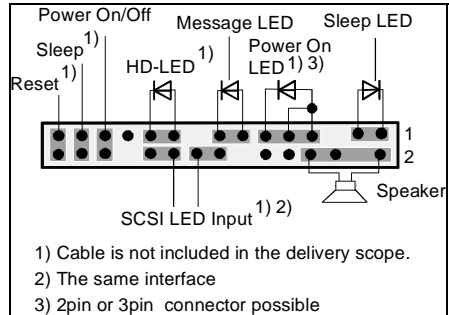

Connection	Note
Reset	
Sleep	This connection is reserved for future use.
Power On/Off	
HD LED	
SCSI Activity Input	Attention: Do not connect to the LED connections of an SCSI controller! This connection is intended for a cable with a 4-pin connector. An SCSI controller reports activity (low-active) via this cable.
Message LED	
Power On LED	Indicates the system state APM or ACPI together with the Sleep LED (see chapter entitled "APM and ACPI system status, energy-saving modes").
Speaker	0,5 W at 8 Ohm
Sleep LED	Indicates the system state APM or ACPI together with the Power-On LED (see chapter entitled "APM and ACPI system status, energy-saving modes").

Power On LED II

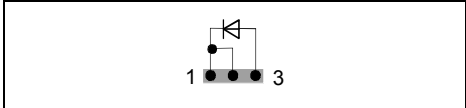

Pin	Note
1	Power On LED (Anode)
2	Power On LED (Anode)
3	Power On LED (Cathode)

Power supply ATX

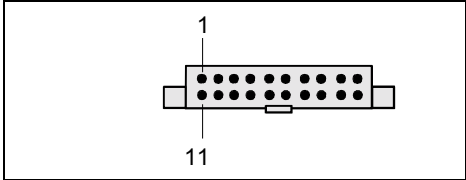

Pin	Signal	Pin	Signal
1	+3.3 V (P3V3P)	11	+3.3 V (P3V3P)
2	+3.3 V (P3V3P)	12	-12 V (P12VN)
3	GND	13	GND
4	+5 V (VCC)	14	PS on (low asserted)
5	GND	15	GND
6	+5 V (VCC)	16	GND
7	GND	17	GND
8	Powergood (high asserted)	18	-5 V (P5VN)
9	+5 V Auxiliary (VCC Aux)	19	+5 V (VCC)
10	+12 V (P12VP)	20	+5 V (VCC)

Power control (system monitoring)

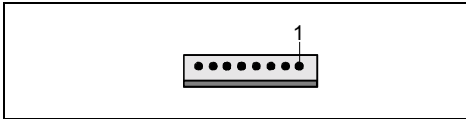

Pin	Signal
1	AC Outlet (high asserted)
2	PS FAN Control (PS FAN C max. 3 mA)
3	Reserved
4	PS FAN Sense
5	SMB CLK
6	SMB DATA
7	VCC EEPROM (+3.3 V)
8	GND

Fan 1

(system fan - supervised)

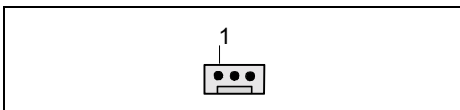

Pin	Signal
1	GND
2	Controlled Fan voltage (0 V, +6 V ... +12 V, max. 1 A) or fix Fan voltage (+12 V, max. 1 A)
3	Fan sense

Fan 2

(system fan - supervised)

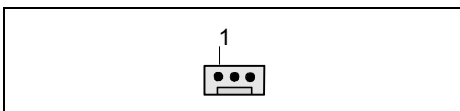

Pin	Signal
1	GND
2	Controlled Fan voltage (0 V, +6 V ... +12 V, max. 1 A) or fix Fan voltage (+12 V, max. 1 A)
3	Fan sense

LCD status indicator

(for use with optional front panel)

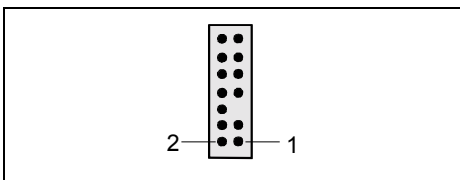

Pin	Signal	Pin	Signal
1	SMB CLK	2	GND
3	SMB DATA	4	GND
5	Key	6	RFU Reserved for Future Use
7	LAN Active Icon	8	LAN Link Icon
9	Harddisk Action Icon	10	BMC Alert Icon
11	Message Icon	12	Sleep Icon
13	Power Icon	14	P3V3P DUAL

USB C/D / E/F - dual channel

(internal or external via special wire)

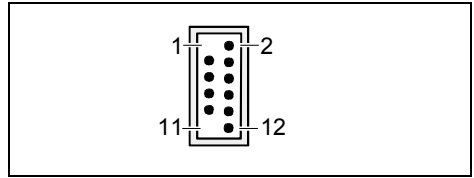

Pin	Signal	Pin	Signal
1	Key	2	Chipcard reader on
3	VCC C	4	VCC D
5	Data negative C	6	Data negative D
7	Data positive C	8	Data positive D
9	GND	10	GND
11	Key	12	Not Connected

Intrusion

for case open detect for optional push-button (opener)

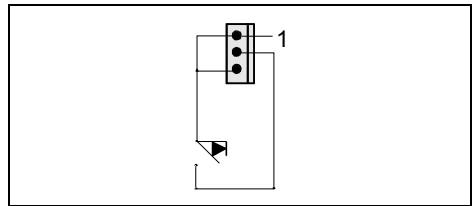

Pin	Signal
1	GND
2	Case open (low asserted)
3	Intrusion switch present (low asserted)

Audio S/PDIF (2-pin)

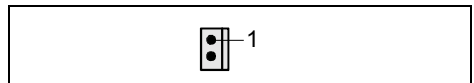

Pin	Signal
1	GND
2	SPDIF out

Audio S/PDIF (3-pin)

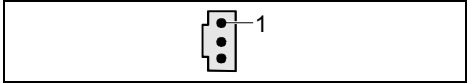

Pin	Signal
1	GND
2	SPDIF out
3	GND

Audio front panel

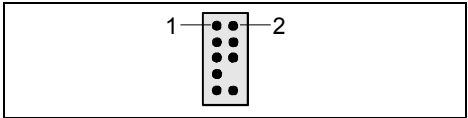

Pin	Signal	Pin	Signal
1	Micro input	2	Analog GND
3	Micro bias	4	Analog VCC
5	Right line output	6	Right line return
7	NC	8	Key
9	Left line output	10	Left line return

CD-ROM audio

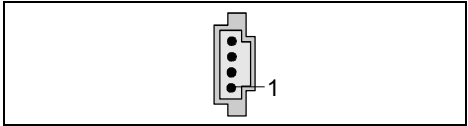

Pin	Signal
1	Left CD audio input
2	CD GND
3	CD GND
4	Right CD audio input

Processor power supply

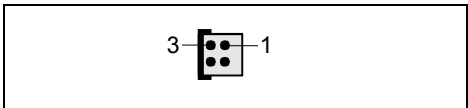

Pin	Signal	Pin	Signal
1	GND	2	+12 V
3	GND	4	+12 V

Settings with switches and jumpers

Your mainboard is equipped with switches or jumpers. The positions of the switches or jumpers are shown on page "Cover".

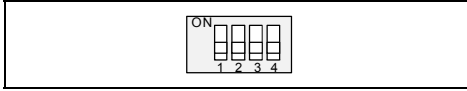

Switch 1 = Skipping system and BIOS Setup password
 Switch 2 = System BIOS recovery
 Switch 3 = must always be set to *off*
 Switch 4 = must always be set to *off*

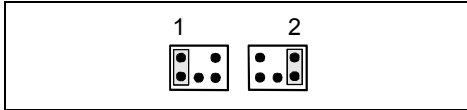

Pinpair 1 inserted =
 Skipping system and BIOS Setup password
 Pinpair 2 inserted =
 System BIOS recovery
 Any other setting =
 State of supply; jumper has no function



The clock frequency of the processor is set automatically.

Skipping system and BIOS Setup password - switch 1 / pinpair 1

Switch 1 enables skipping the system and BIOS Setup password.

On System and BIOS Setup password are skipped when the device is switched on and may be changed.

Off System and BIOS Setup password must be entered when the device is switched on.

Recovering System BIOS - switch 2 / pinpair 2

Switch 2 enables recovery of the old system BIOS after an attempt to update has failed. To restore the old system BIOS you need a Flash BIOS Diskette (see "BIOS update" chapter).

On The System BIOS executes from floppy drive A: and the inserted "Flash-BIOS-Diskette" restores the System BIOS on the mainboard.

Off Normal operation (default setting).

Reserved - switch 3 and switch 4

Switch 3 and 4 are reserved.

Add-on modules / Upgrading



Exit energy-saving mode, switch off the system and remove the power plug from the mains outlet, before carrying out any of the procedures described in this chapter! Even when you have switched off the device, parts (e.g. memory modules, AGP and PCI extension boards) are still supplied with power.

Installing and removing processors

Technical data

Intel Pentium 4 with 400 or 533 MHz front side bus in the mPGA478 design.

A current list of the processors supported by this mainboard is available on the Internet at: www.fujitsu-siemens.de/mainboards.

Installing the processor with heat sink and fan

- ▶ Remove the fan that there may be and the heat sink.

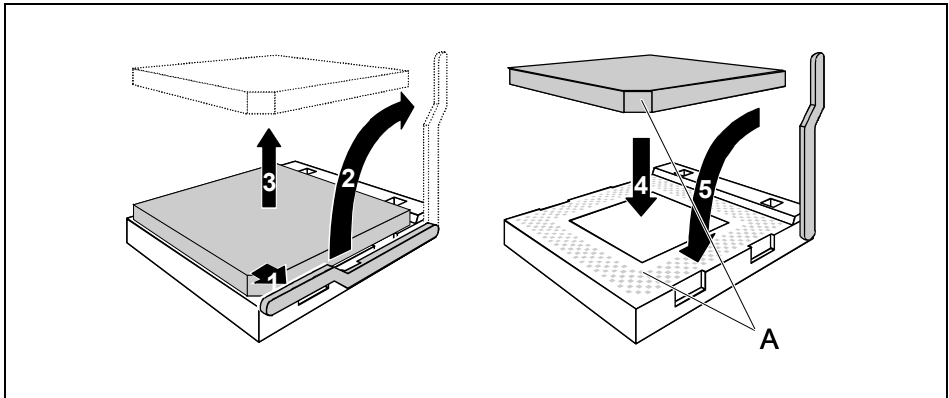

- ▶ Pull the lever in the direction of the arrow (1) and lift it as far as it will go (2).
- ▶ Remove the old processor from the socket (3).
- ▶ Insert the new processor in the socket so that the angled corner of the processor matches the coding on the socket (A) with regard to the position (4).



The angled corner of the processor can also be at a different location than shown in the illustration.

- ▶ Push the lever back down until it clicks into place (5).

Mounting heat sink

Be sure to use heat conducting material between the processor and the heat sink. If a heat conducting pad (rubber-like foil) is already applied to the heat sink, then use it. Otherwise you must apply a very thin layer of heat conducting paste.

Heat conducting pads can only be used once. If you remove the heat sink, you must clean it and apply new heat conducting paste before you remount it.

Please note that, depending on the heat sink used, different heat sink mounts are required on the mainboard.

i

If a counter-plate is mounted on the underside of the mainboard for reinforcement, no heat sinks of the type "Intel Boxed" may be used. Otherwise the retaining clips of the heat sink will be damaged.

When using an "Intel Boxed" heat sink, the mainboard must be converted. This conversion set is either included with the mainboard or is available separately.

If no counter-plate is mounted, you can use both "Intel Boxed" heat sinks and standard heat sinks. If you use the "Intel Boxed" heat sink, the mainboard will bend due to the high pressure of the retaining clips. This behaviour is specified by Intel.

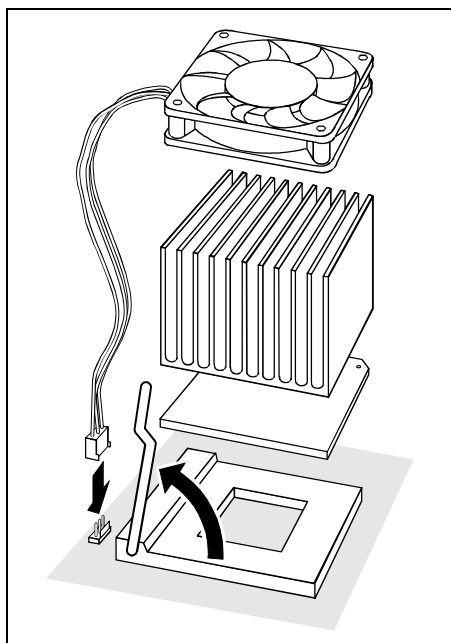

- ▶ Depending on the configuration variant, you must pull a protective foil off the heat sink or coat the heat sink with heat conducting paste before fitting it.
- ▶ Depending on the processor variant, clips may also be supplied for mounting the heat sink that fix it in place.
- ▶ When you have mounted the optional fan, connect the fan plug to the corresponding connection on the mainboard.

Upgrading main memory

Technical data

Technology: DDR 266 or DDR 333 unbuffered DIMM modules
184-pin; 2.5 V; 64 Bit, no ECC

Total size: 128 Mbytes up to 2 Gbyte DDR-SDRAM

Granularity: 32, 64, 128, 256, 512 or 1024 Mbyte for one socket

A current list of the memory modules recommended for this mainboard is available on the Internet at: www.fujitsu-siemens.de/mainboards.

At least one memory module must be installed. Memory modules with different memory capacities can be combined.



You may only use unbuffered 2,5 V memory modules. Buffered memory modules are not supported.

DDR-DIMM memory modules must meet the PC2100 or PC2700 specification.

Installing a memory module

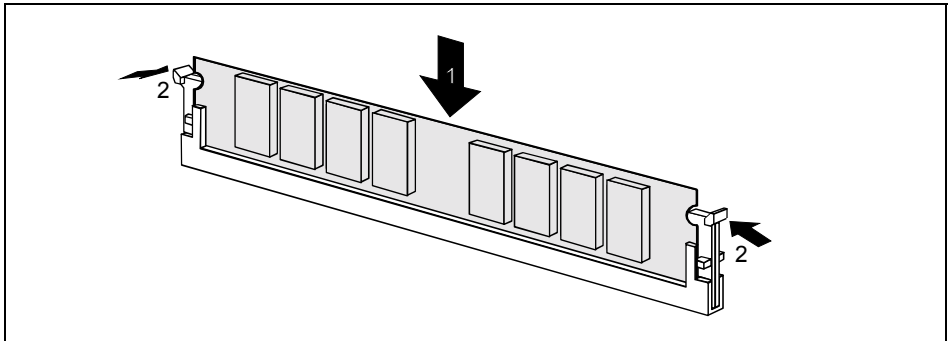

- ▶ Push the holders on each side of the memory compartment outwards.
- ▶ Insert the memory module into the location (1).
- ▶ At the same time flip the lateral holders upwards until the memory module snaps in place (2).

Removing a memory module

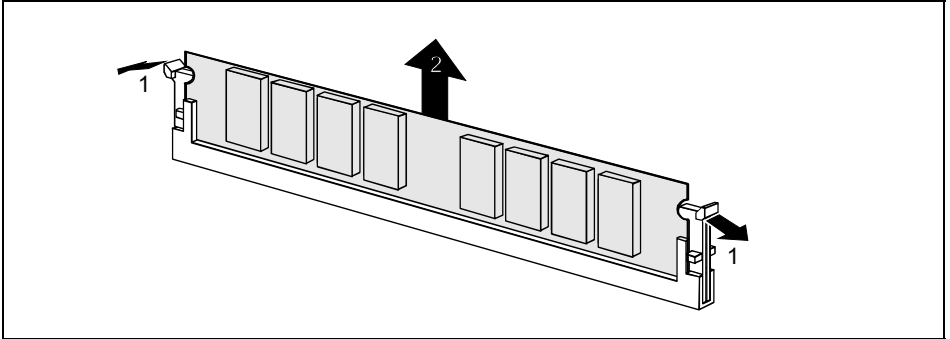

- ▶ Push the clips on the right and left of the compartment outward (1).
- ▶ Pull the memory module from the compartment (2).

Upgrading AGP screen controllers

Technical data:

The AGP slot supports the modes 1x/2x/4x with 32 bits and 66 MHz. Only 1.5 V AGP screen controllers are supported.



Some older 3.3 V AGP screen controllers are coded like 1.5 V AGP screen controllers. The installation of such 3.3 V AGP screen controllers can cause serious damage to the mainboard and the AGP screen controller.

Adding PCI cards

Technical data:

32 bit / 33 MHz PCI slots
5 V and 3.3 V supply voltage
3.3 V auxiliary voltage

PCI bus interrupts - Selecting correct PCI slot



To achieve optimum stability, performance and compatibility, avoid the multiple use of ISA IRQs or PCI IRQ Lines (IRQ sharing). Should IRQ sharing be unavoidable, then all involved devices and their drivers must support IRQ sharing.

PCI IRQ Lines connect AGP slots, PCI slots and onboard components to the interrupt controller. PCI IRQ Lines are permanently wired on the mainboard.

Which ISA IRQs are assigned to the PCI IRQ Lines is normally automatically specified by the BIOS (see description in "BIOS Setup").

Monofunctional expansions cards:

Standard AGP and PCI expansion cards require a maximum of one interrupt, which is called the PCI interrupt INT A. Expansion cards that do not require an interrupt can be installed in any desired slot.

Multifunctional expansion cards or expansion cards with integrated PCI-PCI bridge:

These expansion cards require up to four PCI interrupts: INT A, INT B, INT C, INT D. How many and which of these interrupts are used is specified in the documentation provided with the card.

The assignment of the PCI interrupts to the PCI IRQ Lines is shown in the following table:

PCI INT LINE	Onboard controller													
	USB 1,1					AC97						PCI slot		
	1st	2nd	3rd	USB 2,0	SMB us	Audio	Modem	LAN	AGP	1	2	3		
1 (A)	A	-	-	-	-	-	-	-	A	-	-	-		
2 (B)	-	-	-	-	A	A	A	-	B	A	-	-		
3 (C)	-	-	A	-	-	-	-	-	-	B	A	-		
4 (D)	-	A	-	-	-	-	-	-	-	C	B	A		
5 (E)	-	-	-	-	-	-	-	A	-	D	C	B		
6 (F)	-	-	-	-	-	-	-	-	-	-	D	C		
7 (G)	-	-	-	-	-	-	-	-	-	-	-	D		
8 (H)	-	-	-	A	-	-	-	-	-	-	-	-		

Use the first PCI slots that have a single PCI IRQ Line (no IRQ sharing). If you must use another PCI slot with IRQ sharing, check whether the expansion card properly supports IRQ sharing with the other devices on this PCI IRQ Line. The drivers of all cards and components on this PCI IRQ Line must also support IRQ sharing.

Replacing lithium battery

In order to permanently save the system information, a lithium battery is installed to provide the CMOS-memory with a current. A corresponding error message notifies the user when the charge is too low or the battery is empty. The lithium battery must then be replaced.



Incorrect replacement of the lithium battery may lead to a risk of explosion!

The lithium battery may be replaced only with an identical battery or with a type recommended by the manufacturer.

Do not throw lithium batteries into the household waste. They must be disposed of in accordance with local regulations concerning special waste.

Make sure that you insert the battery the right way round. The plus pole must be on the top!

The lithium battery holder exists in different designs that function in the same way.

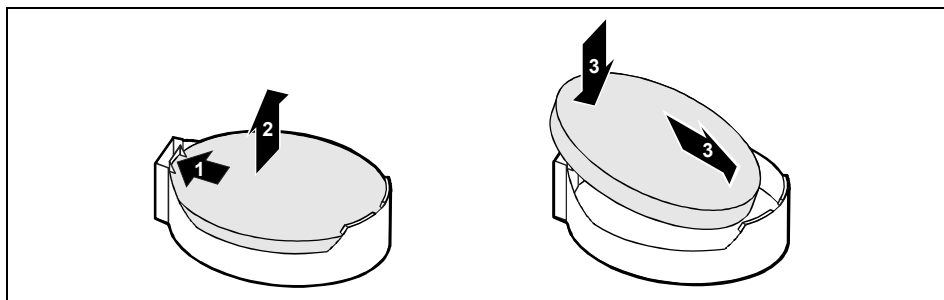
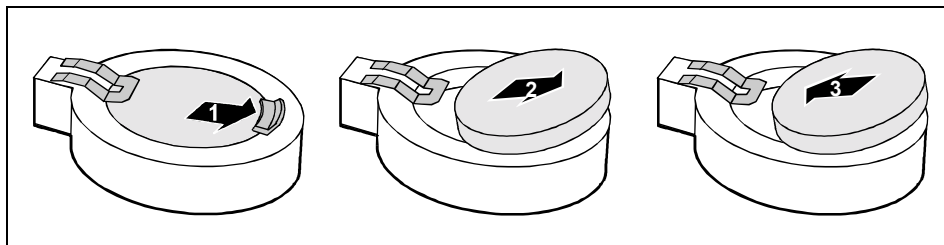

- ▶ Press the locking lug in the direction of the arrow; the battery jumps somewhat out of the holder (1).
- ▶ Remove the battery (2).
- ▶ Insert a new lithium battery of the same type into the socket (3).

BIOS update

When should a BIOS update be carried out?

Fujitsu Siemens Computers makes new BIOS versions available to ensure compatibility to new operating systems, new software or new hardware. In addition, new BIOS functions can also be integrated.

A BIOS update should always also be carried out when a problem exists that cannot be solved with new drivers or new software.

Where can I obtain BIOS updates?

The BIOS updates are available on the Internet at www.fujitsu-siemens.de/mainboards.

How does a BIOS update work?

You have two ways of doing this:

1. BIOS update under DOS with bootable BIOS update floppy disk - brief description

- ▶ Download the update file from our website to your PC.
- ▶ Insert an empty floppy disk (1.44 MB).
- ▶ Run the update file (e.g. 1522103.EXE).
- ▶ A bootable update floppy disk is created. Leave this floppy disk in the drive.
- ▶ Restart the PC.
- ▶ Follow the instructions on screen.



Detailed information on the BIOS update under DOS is provided in the manual on "BIOS Setup" ("Drivers & Utilities" CD).

2. BIOS update under Windows with DeskFlash utility

A BIOS update can also be carried out directly under Windows with the DeskFlash utility. DeskFlash is located on the "Drivers & Utilities" CD (from CD version 2001.05 with DeskView^{OEM} V5.0). In the "Readme" file in the subfolder *DeskFlash* you will find the installation instructions for *DeskFlash*. Further information on *DeskFlash* is provided in the file "DeskView.PDF" and in the DeskView^{OEM} online help.

BIOS Recovery - Recovering System BIOS



All BIOS settings are reset to the default values.

- ▶ Open the casing as described in the operating manual.
- ▶ Set the switch for "Restore system BIOS" to *ON* or plug the corresponding jumper (see "Settings with switches and jumpers" chapter).
- ▶ Close the casing as described in the operating manual.
- ▶ Insert a BIOS update floppy disk and start the PC.
- ▶ Note the signals issued from the loudspeaker. You have successfully restored the BIOS if you hear the signal sequence "short-short- long- long- long" and the diskette access indicator is dark. This can take a few minutes.
- ▶ Open the casing as described in the operating manual.
- ▶ Set the switch for "Restore system BIOS" to *OFF* or remove the corresponding jumper (see "Settings with switches and jumpers" chapter).
- ▶ Close the casing as described in the operating manual.
- ▶ Remove the floppy disk from the drive.
- ▶ Start the PC and invoke *BIOS Setup*.
- ▶ Select the menu item *Reset Configuration* in the menu *Advanced* and change the setting to *Yes*.
- ▶ Save the change and terminate *BIOS Setup*.

The BIOS recovery has now been completed. The system restarts.



Detailed information on the BIOS recovery is contained in the manual "BIOS Setup" ("Drivers & Utilities" CD).

Microcode Update

What is a microcode update?

As there are no drivers for processors, Intel offers the possibility from the P6 family (Pentium Pro) on to update the command set (microcode) of the processor. This enables minor errors to be corrected and the performance to be increased.

To guarantee the best possible performance and error-free operation, Intel recommends updating the microcode regularly. Intel refers to the use of the processor without regular microcode updates as operation outside the specifications.

Safety for processor on Fujitsu Siemens Computers mainboards

If the processor uses an old or incorrect microcode, error-free operation cannot be ensured. Fujitsu Siemens Computers has therefore implemented a function on its mainboards that interrupts the booting process if no suitable microcode is available for the installed processor. The output error message is

Patch for installed CPU not loaded. Please run the bios flash update diskette.

This message appears until the microcode update has been carried out. If the computer is nevertheless operated without a microcode update, error-free operation is not ensured.

When should a microcode update be carried out?

A microcode update should be carried out in the following cases:

- Following installation of a new processor
- When a new microcode update is issued.

In contrast to the BIOS update, only an updated version of the processor command set is stored. The system BIOS remains unaffected by this.

Microcode update under DOS with bootable microcode update floppy disk - brief description

- ▶ Download the update file from our website to your PC.
- ▶ Insert an empty floppy disk (1.44 MB).
- ▶ Run the update file under DOS (e.g. 1495101.EXE).
- ▶ A bootable update floppy disk is created. Leave the floppy disk in the drive.
- ▶ Restart the PC.
- ▶ Follow the instructions on screen.

To determine whether the latest microcode update has been loaded, the so-called Patch-ID of the processor can be read out.

- ▶ Press the **F1** key in the *BIOS Setup*.

The entry *CPU / Patch ID* is shown on the displayed information page.

A list with the current processors and the related Patch-IDs is available on the Internet.



If the processor is not recognised, you also require the microcode update tool for processors of the P6 family.

Drivers

Only when no drivers are installed on your system, or you want to update these, proceed as follows:

- ▶ Insert the CD "Drivers & Utilities Collection" into the CD ROM drive.
- ▶ If the CD does not start automatically, run the *START.EXE* programme in the main directory of the CD.
- ▶ Select *DeskUpdate - Fully automatic installation*.
- ▶ Follow the screen instructions.

Annex

Electrical Properties

Loadability for connections and fuses



Make sure that the connected devices do not overload the connections.

Fuse No.	Fuse	Connection	Maximum loadability
1	750 mA	Keyboard Mouse VGA connector	Not specified Not specified Minimum 50 mA
2	500 mA	USB port A	500 mA
3	500 mA	USB port B	500 mA
4	500 mA	USB port C	500 mA
5	500 mA	USB port D	500 mA
6	500 mA	USB port E	500 mA
7	500 mA	USB port F	500 mA

The fuses on this mainboard can be used several times (polyfuses). Shortly after the error state has been eliminated, the fuses reset to the original state.

Mainboard current requirement

You require a Pentium4 power supply nit as per the ATX12V specification for this mainboard. If you do not have a PC from Fujitsu Siemens Computers, make sure that the power supply unit provides the required amperages.

Source	Voltage	Maximum difference	Maximum current
ATX12V power supply	+12 V	±5 %	3 -6 (8) A
ATX12V power supply	-12 V	±10 %	0,05 A
ATX12V power supply	+5,0 V	±5 %	0,9 A
ATX12V power supply	+3,3 V	±5 %	2,2 (3,4) A
Standby voltage of power supply unit	+5.0 V SB	±5 %	0.35 (2) A

The specifications apply to the onboard components and represent the least favourable case. In addition, at least 350 mA is required for PCI on 3.3 V, and 500 mA per connected device for USB on 5 V.

APM and ACPI system status, energy-saving modes

System status	ACPI Status*		APM Status	Power LED	Sleep LED	Power consumption	Wake-up time
Normal operation	G0	S0	On	To	Off	Normal	
Simple energy-saving mode	G1	S1	Standby	Off	To	Almost like normal	Almost immediately
Maximum energy-saving mode ** "Save to DRAM"		S3				RAM, wake-up components	ca. 5s
Maximum energy-saving mode "Save To Disk"		S4				Wake-up components	ca. 20s
"Soft Off"		G2	S5			Soft Off	Nearly zero
Mechanically Off	G3		Off		Off	Zero	Full boot time

* G = Global status; S = System status

** The power supply unit must provide sufficiently loadable 5 V standby voltage.

To use the WOL functionality the power supply must provide a 5 V auxiliary voltage (5VSB) of at least 1 A.

Mainboard Revision and BIOS Version

The compatibility, e.g. with new processors, can be independent of the BIOS version or the revision status of the mainboard used. The CPU and BIOS compatibility lists are available on the Internet at www.fujitsu-siemens.de/mainboards.

Mainboard: Revision level

The revision status of the mainboard exactly identifies which mainboard you have. It is indicated on a sticker on the edge of the mainboard:

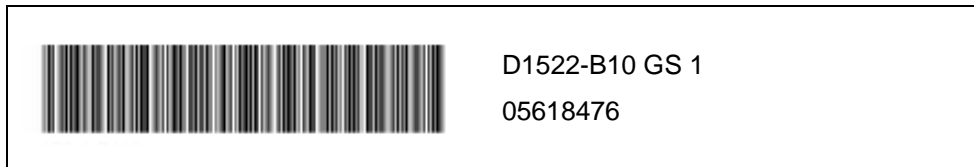

Example of revision status of the mainboard D1522-B10 GS 1

BIOS version

The BIOS version can be displayed in the *BIOS Setup*.

- ▶ Press **F2** during booting to open the *BIOS Setup*.
- ▶ Press **F1**.

The BIOS version is specified on the displayed information page under the entry *BIOS Release*.

Error messages

This chapter contains error messages generated by the mainboard.

Available CPUs do not support the same bus frequency - System halted!
Memory type mixing detected
Non Fujitsu Siemens Memory Module detected - Warranty void
There are more than 32 RDRAM devices in the system

Check whether the system configuration has changed. If necessary, correct the settings.

BIOS update for installed CPU failed

This message appears if the microcode update required for the connected processor is not contained in the system BIOS.

- ▶ Boot the system with the inserted *Flash BIOS floppy disk*.
- ▶ Abort the normal Flash BIOS update by answering the question about whether you want to perform the update with

n 

- ▶ To carry out the Flash BIOS update for the processor, enter:

flashbio_/_p6 

Check date and time settings

The system date and time are invalid. Set the current date and time in the *Main* menu of the *BIOS Setup*.

CPU ID 0x failed

Switch the server off and on again. If the message is still displayed, go into the *BIOS setup* and set the corresponding processor to *Disabled* in the *Server - CPU Status* menu; please contact your sales outlet or customer service centre.

CPU mismatch detected

You have replaced the processor or changed the frequency setting. As a result, the characteristic data of the processor have changed. Confirm this change by running the *BIOS Setup* and exiting it again.

Diskette drive A error

Diskette drive B error

Check the entry for the diskette drive in the *Main* menu of the *BIOS Setup*. Check the connections to the diskette drive.

DMA test failed
EISA CMOS not writable
Extended RAM Failed at offset: nnnn
Extended RAM Failed at address line: nnnn
Failing Bits: nnnn
Fail-Safe Timer NMI failed
Multiple-bit ECC error occurred
Memory decreased in size
Memory size found by POST differed from EISA CMOS
Single-bit ECC error occurred
Software NMI failed
System memory exceeds the CPU's caching limit
System RAM Failed at offset: nnnn
Shadow RAM Failed at offset: nnnn

Switch the device off and on again. If the message is still displayed, please contact your sales outlet or customer service centre.

Failure Fixed Disk 0
Failure Fixed Disk 1
Fixed Disk Controller Failure

Check the entry for the hard disk drive in the *Main* menu and the entry for the IDE drive controller in the *Advanced - Peripheral Configuration* menu of the *BIOS Setup*. Check the hard disk drive's connections and jumpers.

Incorrect Drive A - run SETUP
Incorrect Drive B - run SETUP

Correct the entry for the diskette drive in the *Main* menu of the *BIOS Setup*.

Invalid NVRAM media type

Switch the device off and on again. If the message is still displayed, please contact your sales outlet or customer service centre.

Invalid System Configuration Data

In the *Advanced* menu of the *BIOS Setup* set the entry *Reset Configuration Data* to *Yes*.

Invalid System Configuration Data - run configuration utility
Press F1 to resume, F2 to Setup

This error message may be displayed if the machine was switched off during system start-up.

Call *BIOS Setup* and switch to the *Advanced* menu. Select the menu item *Reset Configuration Data* and change the setting to *Yes*. Save the change and terminate *BIOS Setup*. Reboot the device.

Keyboard controller error

Connect another keyboard or another mouse. If the message is still displayed, please contact your sales outlet or customer service centre.

Keyboard error

Check that the keyboard is connected properly.

Keyboard error nn
nn Stuck Key

Release the key on the keyboard (*nn* is the hexadecimal code for the key).

Error messages

Missing or invalid NVRAM token

Switch the device off and on again. If the message is still displayed, please contact your sales outlet or customer service centre.

Monitor type does not match CMOS - RUN SETUP

Correct the entry for the monitor type in the *Main* menu of the *BIOS Setup*.

On Board PCI VGA not configured for Bus Master

In the *BIOS Setup*, in the *Advanced* menu, submenu *PCI Configuration*, set the *Shared PCI Master Assignment* entry to *VGA*.

One or more RDRAM devices are not used

One or more RDRAM devices have bad architecture/timing

One or more RDRAM devices are disabled

Contact your system administrator or contact our customer service centre.

Operating system not found

Check the entries for the hard disk drive and the floppy disk drive in the *Main* menu and the entries for *Boot Sequence* submenu of the *BIOS Setup*.

Parity Check 1

Parity Check 2

Switch the device off and on again. If the message is still displayed, please contact your sales outlet or customer service centre.

Previous boot incomplete - Default configuration used

By pressing function key **[F2]** you can check and correct the settings in *BIOS Setup*. By pressing function key **[F1]** the system starts with incomplete system configuration. If the message is still displayed, please contact your sales outlet or customer service centre.

Real time clock error

Call the *BIOS Setup* and enter the correct time in the *Main* menu. If the message is still displayed, please contact your sales outlet or customer service centre.

Service Processor not properly installed

The server management controller has not been correctly installed. If the message is still displayed, please contact your sales outlet or customer service centre.

Storage Extension Group = xy

Configuration error, x Storage Extensions(s) found, configured are y SE(s).

Device List: k1, k2 ...

The specified number of storage expansion units (SEs) in the *BIOS Setup* menu *Server - Storage Extensions - Number of connected SE* is incorrect. Check how many SEs within the group are connected at the server and change the setting in *BIOS Setup*. Check whether you have assigned the same device ID twice.

xy = Group number

x = Number of SEs found on the communication bus

y = Number of SEs entered in *Number of connected SE*

k1, k2 ... = Device ID of the storage extensions found

System battery is dead - Replace and run SETUP

Replace the lithium battery on the mainboard and redo the settings in the *BIOS Setup*.

System Cache Error - Cache disabled

Switch the device off and on again. If the message is still displayed, please contact your sales outlet or customer service centre.

System CMOS checksum bad - - Default configuration used

Call the *BIOS Setup* and correct the previously made entries or set the default entries.

System Management Configuration changed or Problem occurred

A system fan or system sensor has failed. Check the hardware operation.

System timer error

Switch the device off and on again. If the message is still displayed, please contact your sales outlet or customer service centre.

Uncorrectable ECC DRAM error

DRAM Parity error

Unknown PCI error

Switch the device off and on again. If the message is still displayed, please contact your sales outlet or customer service centre.

Verify CPU frequency selection in Setup

The frequency setting for the processor is invalid. Correct the *BIOS Setup* and the setting.

DOS error messages

This chapter contains the error messages that occur while DOS is running.

If a uncorrectable error occurs while DOS is running, then the following error text is output on the screen:

Critical error logged to server management processor - system halted

If the NMI button of the control panel is pressed, then the following error text is output on the screen:

Frontpanel NMI activated - system halted

SmartCard reader - error messages

This chapter contains error messages generated by the SmartCard reader (chipcard reader).

Boot access denied

The Sicrypt SmartCard has no access rights to the system.

Check your chipcard

Either the Sicrypt SmartCard has been wrongly inserted, or it is not a *PC-Lock* Sicrypt card.

Chipcard reader FAIL

An error has occurred on the serial port to the SmartCard reader (chipcard reader). If this error occurs always or often, the connection between the SmartCard reader and the mainboard must be checked, or the SmartCard reader must be replaced. While the error is present, access to the system is blocked.

Non authorized chipcard

The Sicrypt SmartCard cannot be used on this PC. The Sicrypt SmartCard has been configured for a different PC.

PC-Lock installation FAIL:

An error has occurred during installation of PC Lock. Do not switch off, but insert the "BIOS Flash diskette", and try the installation again.

The chipcard is blocked.

Enter the Admin PIN:

You have exceeded the maximum number of failed attempts to enter the PIN. The Sicrypt SmartCard is blocked.

Enter the administrator PIN to re-activate the Sicrypt SmartCard. You must then enter a new User PIN to restart the system.

Glossary

The technical terms and abbreviations given below represent only a selection of the full list of common technical terms and abbreviations.

Not all technical terms and abbreviations listed here are valid for the described mainboard.

ACPI	Advanced Configuration and Power Management Interface	ISA	Industrial Standard Architecture
AC'97	Audio Codec '97	LAN	Local Area Network
AGP	Accelerated Graphics Port	LSA	LAN Desk Service Agent
AMR	Audio Modem Riser	MCH	Memory Controller Hub
AOL	Alert On LAN	MMX	MultiMedia eXtension
APM	Advanced Power Management	P64H	PCI64 Hub
ATA	Advanced Technology Attachment	PCI	Peripheral Component Interconnect
BIOS	Basic Input Output System	PXE	Preboot eXecution Environment
BMC	Baseboard management controller	RAM	Random Access Memory
CAN	Controller Area Network	RAMDAC	Random Access Memory Digital Analogue Converter
CPU	Central Processing Unit	RDRAM	Rambus Dynamic Random Access Memory
CNR	Communication Network Riser	RIMM	Rambus Inline Memory Module
C-RIMM	Continuity Rambus Inline Memory Module	RTC	Real Time Clock
DIMM	Dual Inline Memory Module	SB	Soundblaster
ECC	Error Correcting Code	SDRAM	Synchronous Dynamic Random Access Memory
EEPROM	Electrical Erasable Programmable Read Only Memory	SGRAM	Synchronous Graphic Random Access Memory
FDC	Floppy disk controller	SIMD	Streaming Mode Instruction (Single Instruction Multiple Data)
FIFO	First-In First-Out	SMBus	System Management Bus
FSB	Front Side Bus	SVGA	Super Video Graphic Adapter
FWH	Firmware Hub	USB	Universal Serial Bus
GMCH	Graphics and Memory Controller Hub	VGA	Video Graphic Adapter
GPA	Graphics Performance Accelerator	WOL	Wake On LAN
I ² C	Inter Integrated Circuit		
IAPC	Instantly Available Power Managed Desktop PC Design		
ICH	I/O Controller Hub		
IDE	Intelligent Drive Electronics		
IPSEC	Internet Protocol Security		