

CHAMBERLAIN®

LiftMaster®
PROFESSIONAL

ESTATE SERIES

CONTROLLER BOARD
B3

MASTER / SLAVE SYSTEMS

MODEL SL 1000-B3, SW 2000-B3 & BG 3000-B3

SLIDE, SWING, AND BARRIER GATE OPERATORS

MODEL SL 1000-B3



MODEL BG 3000-B3



MODEL SW 2000-B3



TABLE OF CONTENTS

SAFETY SUMMARY	1
BASIC INSTALLATION HINTS AND RULES	2
PART 1 MASTER/SLAVE OPERATION	3
A. WHAT IS MASTER/SLAVE OPERATION?.....	3
B. MASTER/SLAVE GATE CONFIGURATIONS.....	3
C. MASTER/SLAVE INSTALLATION DETAILS	3
PART 2 MASTER/SLAVE LAYOUTS AND WIRING	10
A. PHOTO-SENSOR INSTALLATION FOR BIPARTING GATE CONFIGURATION	10
B. PHOTO-SENSOR INSTALLATION FOR TRAP/TANDEM GATE CONFIGURATION	12
C. CONNECTING INPUT WIRING	13
D. MASTER/SLAVE INTERCONNECTION.....	14
E. MASTER/SLAVE WIRING.....	15
F. SWITCH S1 MASTER SLAVE CONFIGURATIONS AND GATE CONTROLS SETTINGS:.....	15
G. SYSTEM LAYOUTS AND CONTROL WIRING	16
H. TROUBLESHOOTING	30
FCC REQUIREMENTS	31
NOTICE TO CANADIAN USERS	32

TABLE OF FIGURES

Figure 1. Master/Slave Gate Configurations.....	3
Figure 2. Typical Bi-Parting Gate Installation.	4
Figure 3. Typical Bi-Parting Latch Gate Installation.....	5
Figure 4. Typical Trap Gate Installation.....	6
Figure 5. Typical Tandem Gate Installation.	8
Figure 6. Biparting Slide Gate Photo-Sensor Layout.....	10
Figure 7. Biparting Swing Gates Photo-Sensor Layout.	11
Figure 8. Biparting Barrier Gates Photo-Sensor Layout.	12
Figure 9. Control Board Wiring.	13
Figure 10. Master Slave Connection and Switch S1 Location.....	15
Figure 11. Switch S1 Settings for Master/Slave Systems.....	16
Figure 12. Bi-Part, Bi-Directional Gate System.	17
Figure 13. Bi-Part, Uni-Directional Gate System (Swing gate, if used, opens in).....	17
Figure 14. Bi-Part, Uni-Directional Gate System (Swing gate opens out).	18
Figure 15. Bi-Part, Bi-Directional Gate System.	18
Figure 16. Bi-Part Latch, Uni-Direction Gate System (Swing gate, if used, opens in).....	19
Figure 17. Bi-Part Latch, Uni-Directional Gate System (Swing gate opens out).	19
Figure 19. Bi-Directional Trap Gate System (Swing gate opens out).	21
Figure 20. Uni-Directional Trap Gate System (internal Swing gate, if used, opens in).....	22
Figure 21. Uni-Directional Trap Gate System (internal Swing gate opens out).	23
Figure 22. Uni-Directional Trap Gate System (external Swing gate, if used, opens in).....	24
Figure 23. Uni-Directional Trap Gate System (external Swing gate opens out).	25
Figure 24. Bi-Directional Tandem Gate System (Swing gate, if used, opens in).....	26
Figure 25. Bi-Directional Tandem Gate System (Swing gate opens out).	27
Figure 26. Uni-Directional Tandem Gate System (Swing gate, if used, opens in).....	28
Figure 27. Uni-Directional Tandem Gate System (Swing gate opens out).	29

SAFETY SUMMARY

It is important for everyone involved in the installation and operation of the LiftMaster models SL 1000, SW 2000, and BG 3000 Master/Slave systems to read the following warnings.

WARNING!

- A vehicle gate is a large, heavy object that is moved by an electric motor. A moving gate can cause serious injury or death! The safety and well-being of others depends on the installation of a safe system.
- **READ AND FOLLOW ALL INSTRUCTIONS.** Improper installation of a gate operator can result in a dangerous system. **SAVE THESE INSTRUCTIONS**
- The entrance is for vehicles only. Pedestrians must use separate entrance.
- Gate operators can present serious hazards to persons in the immediate area when not controlled in a safe manner. Choose one or more controls which together will allow complete control of the gate. Most importantly, the gate must be able to be stopped at all times in case of emergency, and the emergency control should be conveniently located, clearly marked, and visible.
- All controls must be kept out of reach of small children. Serious injury or death can result from children playing with the controls.
- Always keep people and objects away from the gate. **NO ONE SHOULD CROSS THE PATH OF THE MOVING GATE.**
- All controls should be located so the person operating them can see the full area of gate movement.
- Use the emergency release only when the gate is not moving.
- **KEEP GATES PROPERLY MAINTAINED.** Read the Installation and Operation manual. Have a qualified person make repairs to gate hardware.
- Test the gate operator safety features monthly. The gate **MUST** reverse on contact with a rigid object or stop when an object activates the non-contact sensors.
- After adjusting the force or the limit of travel, retest the gate operator. Failure to adjust and retest the gate operator properly can increase the risk of damage, injury or death.
- Gate operators and associated control equipment should be installed by qualified professional installers who should observe the following safe installation procedures:
 1. Power should always be disconnected whenever installing, wiring, or servicing a gate operator. Moving chains and belts in gate operators can catch clothing or fingers and cause severe injury.
 2. Installation of wiring should comply with all local building and electrical codes.
 3. All manual gate locks should be disabled to avoid damage to the gate or gate operator should the lock become engaged after the operator is installed.
 4. All operator controls and safety equipment should be tested at the conclusion of installation to be sure they are functioning properly.
 5. The operation of the gate controls and safety equipment should be reviewed with the owner and/or end user of the automated gate system. They should also be informed of the need to maintain control and safety equipment on a regular basis. Safety equipment should be checked monthly to ensure it is working properly. All installation manuals and safety information should be left with the owner.
 6. Moving gates have pinch points and entrapment zones which can be extremely dangerous to pedestrians, especially small children.

BASIC INSTALLATION HINTS AND RULES

READ THIS SECTION CAREFULLY BEFORE BEGINNING YOUR INSTALLATION

1. **UNDERSTAND THE SYSTEM AND INSTALLATION SITE THOROUGHLY.** The B3 series are flexible and reliable gate operator systems, but the quality of service depends directly on the quality of installation. Please read these instructions and the Installation and Operation instructions for each gate operator carefully. Study the applicable diagrams before planning your installation. In particular, understand any site characteristics that may affect the system installation.

WARNING

2. **INSTALL PERMANENT WIRING.** U.L. specifications require the B3 Series Master/Slave systems to be permanently wired. Refer to your local wiring code for specific information.

WARNING: Damage caused by faulty wiring is not covered by warranty.

3. **GROUND THE SYSTEM.** The system contains parts which may be damaged by static discharge. A proper earth ground connected to the housing will significantly reduce the chances of damage or improper operation. The shielding in the cables specified for all remote sensors and controls should also be connected to earth ground at the controller end of the cable only.

To be effective, the ground connection must be made by running 12 AWG copper wire to a good ground point (e.g., an electrical panel, a metallic cold water pipe that runs into the earth, or a grounding rod at least 10 feet in length that is driven into the earth) within 12 feet of the system. Even if you have a good ground, you should try to discharge any static before handling the circuit boards.

WARNING: Damage caused by static discharge and lightning is not covered by warranty.

4. **PROVIDE POWER FROM A DEDICATED SOURCE.** The outlet into which you connect the Gate Operators should be wired to its own circuit breaker. This will reduce the line noise introduced into system power and minimize the risk of having other equipment interrupt system operation. In a Master/Slave system, Master and Slave must each have separate circuits.

5. **DO NOT OVERLOAD THE TERMINAL BLOCKS.** The operator's terminal blocks are removable and the pins are soldered into the boards. To connect the wires, remove the "head" from the correct terminals and open the screws. Insert the wire into the correct opening on the front and tighten the screw until the wire is held firmly. When you have made all connections for a given "head", plug it back onto the pins designated for that terminal block.

Stranded wire must be between 16 and 24 AWG. Solid wire must be between 18 and 24 AWG. This is the total thickness measurement so, if you are putting two wires in, the combined thickness must fall within this range. **NEVER** try to insert more than two wires per terminal.

6. **ENSURE GOOD CONNECTIONS.** A light tug on the wire will tell you if the connection is secure. When reconnecting system components, make sure all pins are straight on chips, connectors, and terminal block heads.
7. **READ MARKINGS CAREFULLY.** The connection points are marked on the boards clearly. Before making any connection, be sure to read the marking and check it against the corresponding figure in these instructions so that you understand the connection you are making.
8. **TRAIN YOUR CUSTOMERS THOROUGHLY.** Although customer responsibility is limited to proper installation, the quality of service is determined by the care of system set up. Ensure that the customer has a copy of this manual to guide them. It will save you and them lots of inconvenience and aggravation later.

PART 1

MASTER/SLAVE OPERATION

A. WHAT IS MASTER/SLAVE OPERATION?

The easy way to understand master/slave operation is by the computer terms “smart” and “dumb”.

- “Smart” machines are controlled by a computer or dedicated microprocessor, such as microwave ovens and new-style washing machines.
- “Dumb” machines are controlled by simple electronic or physical mechanisms, like old-style washing machines with their cams and timers.

When your installation requires using two gates together, they can be controlled either by the “dumb” method of wiring them in parallel and using limit cams and reclose timers for control (see the Installation and Operation manual for the individual gate operator), or the “smart” method of enabling the Master/Slave programming built into the gate operators.

LiftMaster gate operators are capable of handling any gate combination you’re likely to need, and we strongly recommend using the “smart” method for the following reasons:

1. **Synchronization:** Gate actions (opening, closing, etc.) are synchronized in Master/Slave operation.
2. **Added safety:** A fault in one unit affects both units, providing added safety to the system.
3. **Reduced wiring:** Inputs (radio, exit loops, etc.) need be wired to only one unit in some Master/Slave configurations.
4. **Simplified gate setting:** Gate controls (Anti-Tailgate, Reclose Timer, etc.) only need to be set in one unit in some Master/Slave configurations.

Let’s take a quick look at some Master/Slave gate configurations, cover the wiring and setup procedures, then go into the details of each type to help plan your installation.

B. MASTER/SLAVE GATE CONFIGURATIONS

LiftMaster models SL 1000-B3 (slide gate), SW 2000-B3 (swing gate), and BG 3000-B3 (barrier gate) can be teamed as Master/Slave systems in the following configurations:

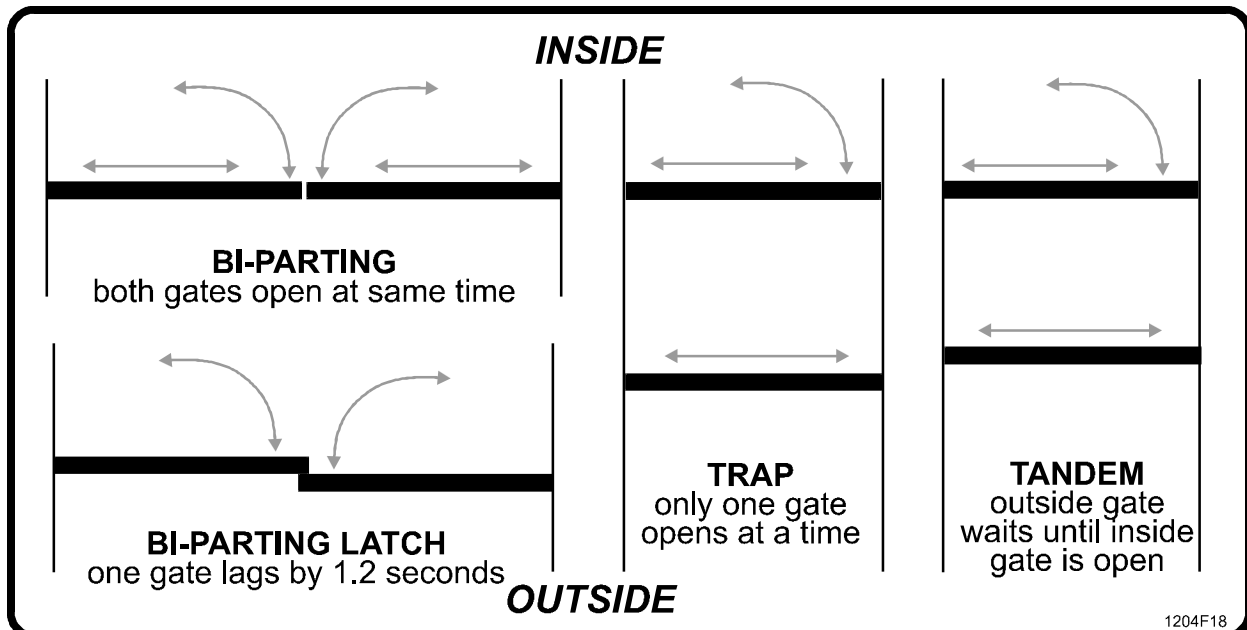

Figure 1. Master/Slave Gate Configurations.

- In the Master/Slave configuration, one Master unit controls one Slave unit.
- Master and Slave units communicate at 9600 baud via a 4-wire interconnection cable.

C. MASTER/SLAVE INSTALLATION DETAILS

1. BI-PARTING GATE DETAILS

The simple Bi-Parting Gate is typically used in low traffic residential sites due to its ease of use. The Bi-Parting configuration can consist of any combination of models SL 1000-B3 (slide gate), SW 2000-B3 (swing gate), and BG 3000-B3 (barrier gate).

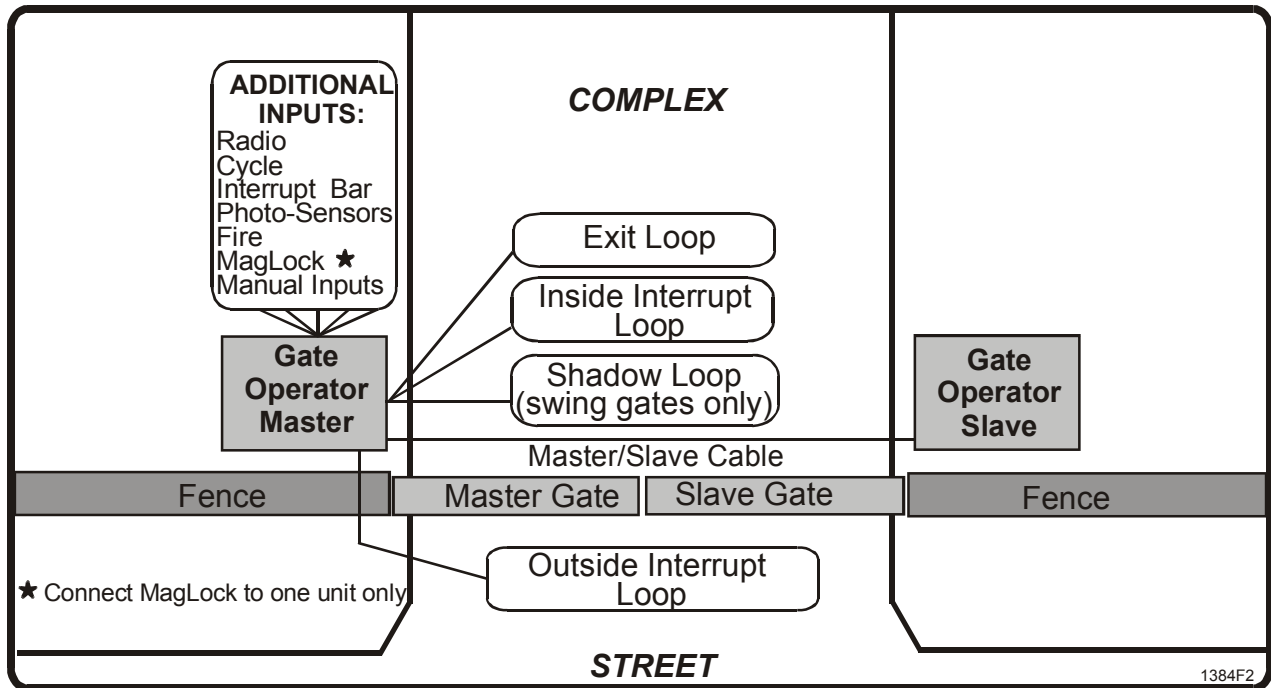

Figure 2. Typical Bi-Parting Gate Installation.

HOW IT WORKS:

- The gates in a Bi-Parting configuration are mirror images of each other and act identically.
- A Fault in one unit affects both units (see Troubleshooting/Maintenance for Fault List in the Installation and Operation manual for the individual gate).
- A Continuous open input in either unit opens the gates and holds them open.

There are 3 different ways to close the gates (entering or exiting):

1. Reclose Timer: When the Reclose Timer expires, gates close automatically.
2. ATG (Anti-Tailgate) and Interrupt Loop: With ATG ON, clearing the Inside Interrupt Loop closes the gates. **NOTE:** For safety reasons, ATG does not function with gate type SWING or LINEAR.
3. Alternate Action: With ATG and TIMER OFF, a Radio or CYCLE command will close fully-open gates.

INPUT CONNECTIONS: Refer to Part 2, Master/Slave Layout and Wiring, for more details.

- Inputs can be connected to either gate.

2. BI-PARTING LATCH GATE DETAILS

The Bi-Parting Latch Gate is typically used in low traffic residential sites due to ease of use and added security of magnetic locking. The Bi-Parting Latch configuration can consist of any combination of models SL 1000-B3 (slide gate), SW 2000-B3 (swing gate), and BG 3000-B3 (barrier gate).

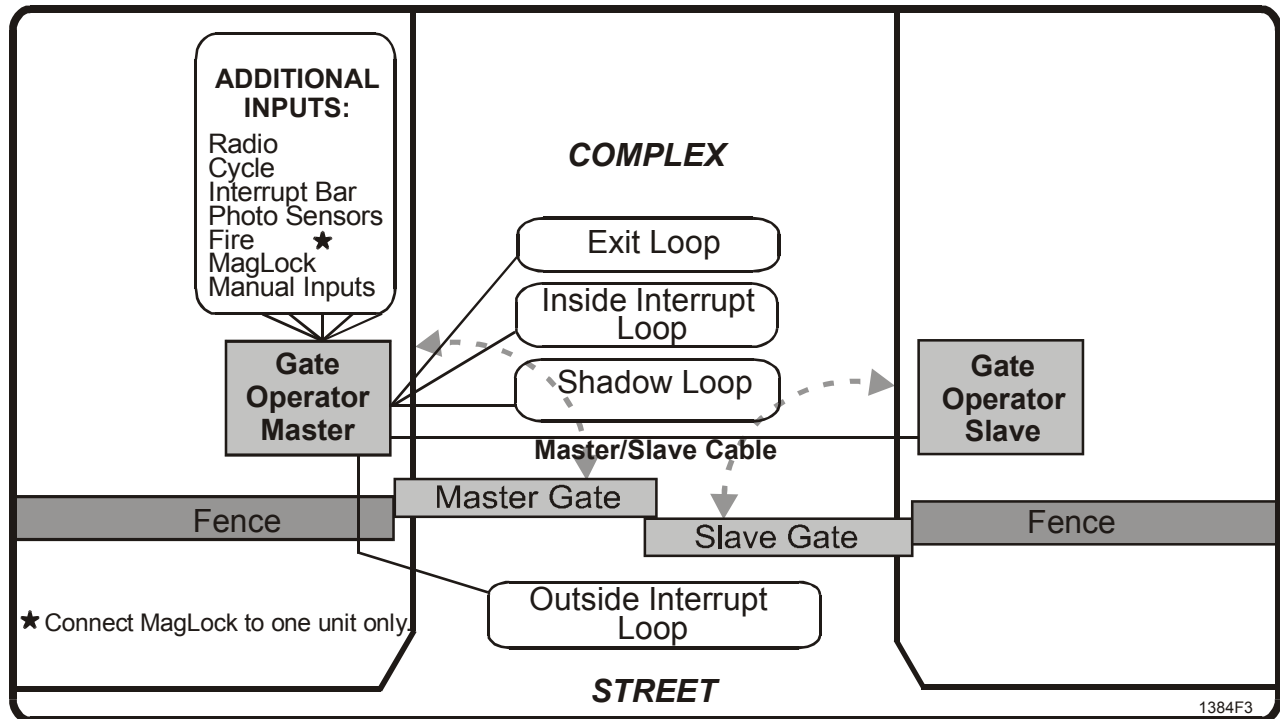

Figure 3. Typical Bi-Parting Latch Gate Installation.

HOW IT WORKS:

- The Master moves first during opening and the Slave first during closing, with a 2 second delay between them to prevent gate intercollision and to ensure proper latching. When the gates are fully closed, the outer edge of the Master gate rests on the outer edge of the Slave gate.
- A fault in one unit affects both units (see Troubleshooting/Maintenance for Fault List in the Installation and Operation manual for the individual gate operator).
- A continuous open input in either unit opens the gates and holds them open.

There are 3 different ways to close the gates (entering or exiting):

1. Reclose Timer: When the Reclose Timer expires, gates close automatically.
2. ATG (Anti-Tailgate) and Interrupt Loop: With ATG ON, clearing the Inside Interrupt Loop closes the gates. **NOTE:** For safety reasons, ATG does not function with gate type SWING or LINEAR.
3. Alternate Action: With ATG and TIMER OFF, a RADIO or CYCLE command will close the fully open gates.

INPUT CONNECTIONS: Refer to Part 2, Master/Slave Layout and Wiring, for more details.

- Inputs can be connected to either unit.

3. TRAP GATE DETAILS

The Trap gate is typically used in secured sites for screening incoming and/or outgoing traffic. In the Trap configuration, only one gate opens at a time, “trapping” the vehicle between gates. Due to ease of use, Slide Gates are the most popular for the Trap configuration. The Trap configuration can consist of any LiftMaster model for the Master, and a model SL 1000-B3 (slide gate), or BG 3000-B3 (barrier gate) for the Slave. **NOTE:** The SW 2000-B3 (swing gate) may not be used for the Slave gate.

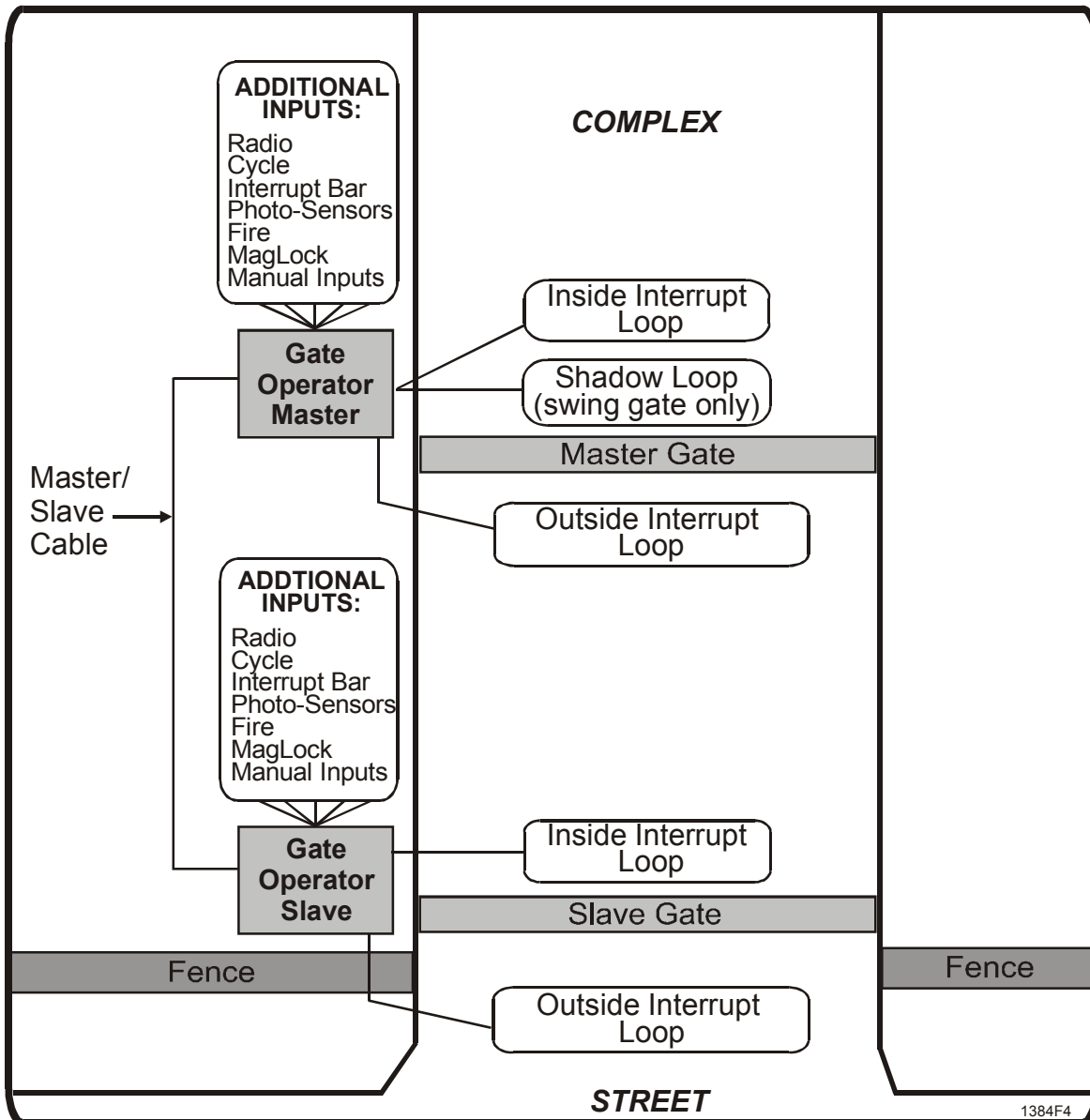

Figure 4. Typical Trap Gate Installation.

HOW IT WORKS

- In normal operation, one gate must completely close before the other opens, so only one gate is open at a time. As soon as one gate closes, the second gate automatically opens. If the second gate does not open within 10 seconds, the first gate reopens to let the vehicle exit the trap area.
- ATG (Anti-Tailgate) is always active for both Master and Slave units. Each gate closes as soon as its Inside Interrupt loop clears.
- Faults and Manual Input Commands in one unit affect both units.
- A continuous FIRE or Manual OPEN input in either unit opens the gates and holds them open.
- If a vehicle stalls between the gates and they close, they can be opened by a CYCLE or RADIO command, or by driving over the Slave unit Inside Interrupt Loop (gate to SLIDE or BARRIER only).

There are 2 different ways to close the gate (entering or exiting):

1. Reclose Timer: When the Reclose Timer expires, gate closes automatically (Master or Slave).
2. Interrupt Loop: clearing the Inside Interrupt Loops cause the gates to close (Master or Slave).

NOTE: To ensure gate closure, set Reclose Timer = ON in both Master and Slave units.

INPUT CONNECTIONS: Refer to Part 2 Master/Slave Layout and Wiring, for more details

- Master and Slave units require their own separate inputs.
- If Radio inputs are used in both units, each requires its own transmitter and entry code.

4. TANDEM GATE DETAILS

The Tandem gate is typically used in high traffic situations where some control of incoming and/or outgoing traffic is required. The outside gate (slave) is usually a less expensive fast moving barrier gate (or light slide gate) which protects the more expensive and less mobile Slide or Swing inside gate (master). The outside gate does this by stopping the vehicle until the inside gate is completely open. The Tandem configuration can consist of any LiftMaster model for Master, and a model SL 1000-B3 (slide gate), or BG 3000-B3 (barrier gate) for Slave. NOTE: The SW 2000-B3 (swing gate) may not be used for Slave.

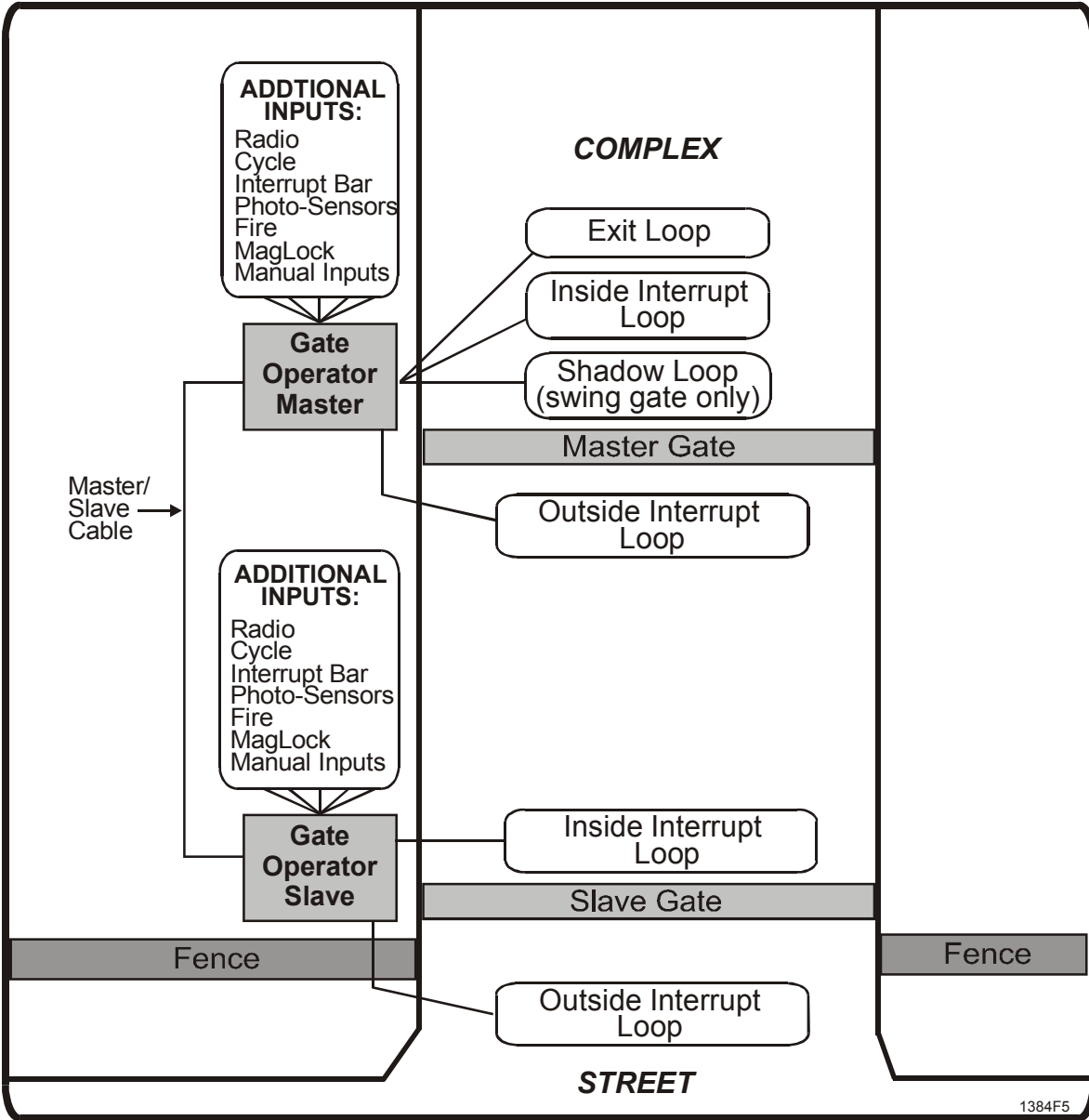

Figure 5. Typical Tandem Gate Installation.

HOW IT WORKS:

- When a vehicle is entering or exiting, the inside Master gate opens first. When the Master is completely open, the outside Slave gate opens, allowing the vehicle to enter or exit.
- The Master unit Reclose Timer (if enabled) does not start counting down until the Slave gate is fully closed. Since ATG is not allowed in the Master unit, if the Reclose Timer is not enabled, the Master gate will remain open.
- During high traffic hours, the slower-moving Master gate can be latched open by a continuous Manual Open input, leaving the faster moving Slave gate to control entering and exiting traffic.
- If a vehicle stalls between the gates and they close, they can be opened by a CYCLE or RADIO command, or by driving over the Slave unit Inside Interrupt Loop (SLIDE ACTION=ON only).
- A fault in one unit affects both units (For Fault List, see Troubleshooting/Maintenance in Installation and Operation manual for individual gate operator).
- A continuous FIRE input in either unit opens both gates and holds them open.
- A continuous Manual OPEN in the Slave unit opens both gates and holds them open.

There are 2 different ways to close the gate after entering or exiting:

1. Reclose Timer: When the Reclose Timer expires, the gates close automatically (Slave or Master).
2. ATG (Anti-Tailgate) and Interrupt Loop: When ATG is ON, clearing the Inside or Outside Interrupt Loop causes the Slave gate to close.

INPUT CONNECTIONS: Refer to Part 2 Master/Slave Layout and Wiring, for more details.

- **Barrier Gate:** If the installation requires only one Loop Sensor for the Slave gate:
 1. Install the Loop Sensor under the barrier gate arm.
 2. Connect to the Outside Interrupt Loop input.

PART 2

MASTER/SLAVE LAYOUTS AND WIRING

A. PHOTO-SENSOR INSTALLATION FOR BIPARTING GATE CONFIGURATION

BIPARTING SLIDE GATES

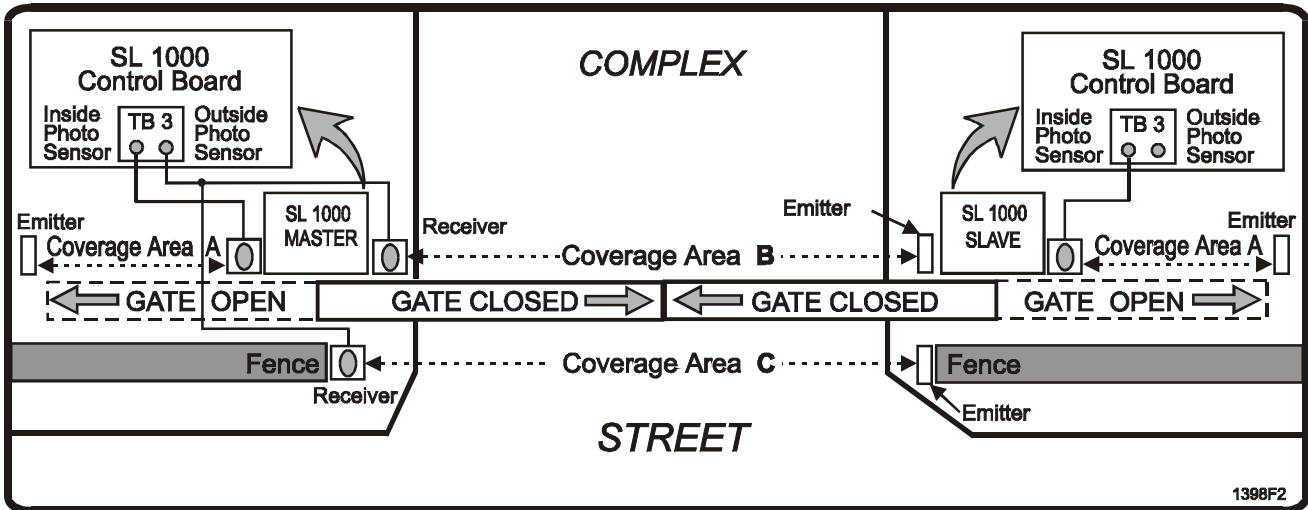

Figure 6. Biparting Slide Gate Photo-Sensor Layout.

WARNING

Buy only UL-approved photo-sensors made for use with vehicular gate operators or system. Otherwise, safe gate operation may be compromised.

IMPORTANT NOTE: The installation shown in Figure 6 above is a suggested layout using emitters and receivers. Any UL-approved photo-sensors are acceptable, **but they must cover the entire area of gate travel to be effective.**

Install photo-sensors in three **Coverage Areas** as shown in Figure 6.

1. **Coverage Area A** - Inside-Open Coverage:
Install two photo-sensors: Inside the fence line, from the gate operators to the gate fully open positions.
2. **Coverage Area B** - Inside-Closed Coverage:
Install one photo-sensor: Inside the fence line, from the Master gate operator to the Slave gate operator.
3. **Coverage Area C** - Outside-Closed Coverage:
Install one photo-sensor: Outside the fence line, from one fence edge to the other.
4. Connect the photo-sensors to whichever unit is most convenient. For wiring instructions, see Section C, Connecting Input Wiring, below.

BIPARTING SWING GATES

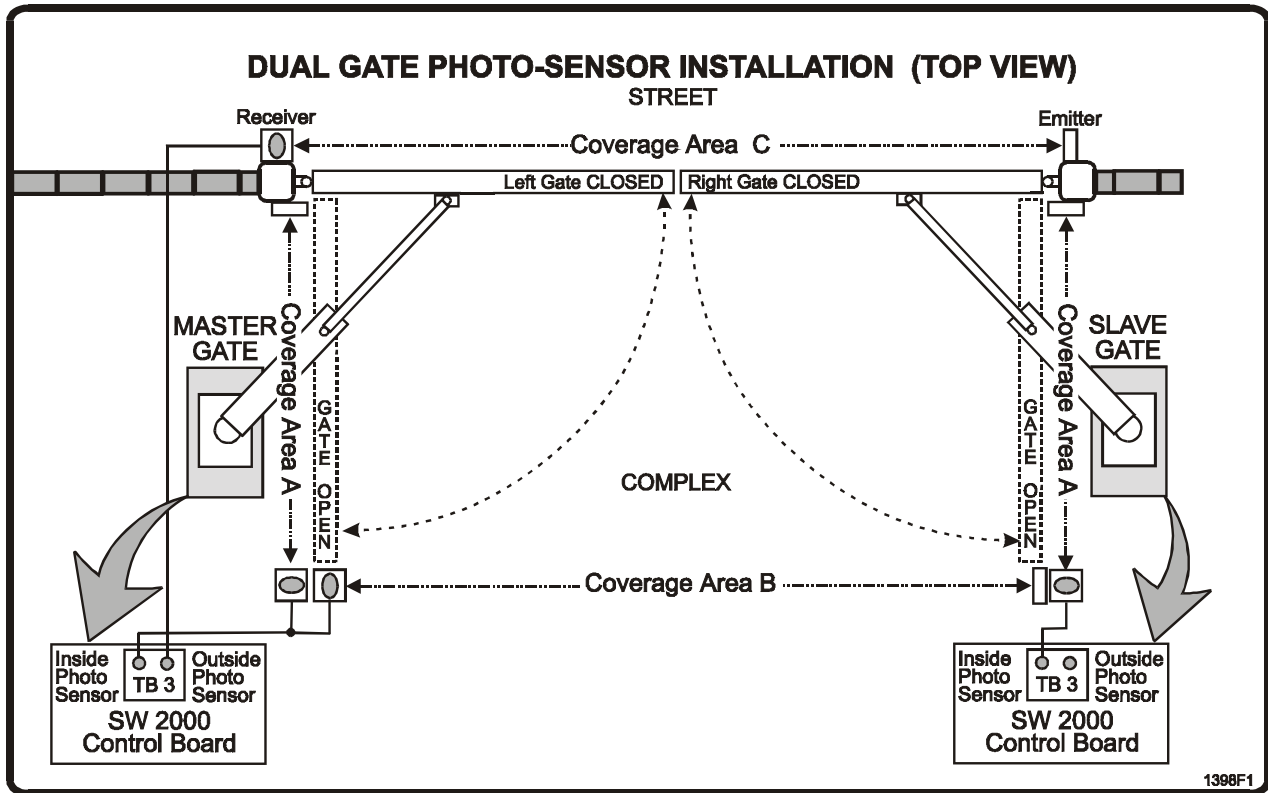

Figure 7. Biparting Swing Gates Photo-Sensor Layout.

WARNING

Buy only UL-approved photo-sensors made for use with vehicular gate operators or system. Otherwise, safe gate operation may be compromised.

IMPORTANT NOTE: The installation shown in Figure 7 above is a suggested layout using emitters and receivers. Any UL-approved photo-sensors are acceptable, **but they must cover the entire area of gate travel to be effective.**

Install photo-sensors in three **Coverage Areas** as shown in Figure 7.

1. **Coverage Area A** - Inside-Open Coverage:
Install two photo-sensors: Inside the fence line, from the gate posts to the gate fully open positions.
2. **Coverage Area B** - Inside-Closed Coverage:
Install one photo-sensor: Inside the fence line, from the gate open position across the full length of both gates.
3. **Coverage Area C** - Outside-Closed Coverage:
Install one photo-sensor: Outside the fence line, from gate post to gate post.
4. Connect the photo-sensors to whichever unit is most convenient. For wiring instructions, see Section C, Connecting Input Wiring, below.

BIPARTING BARRIER GATES

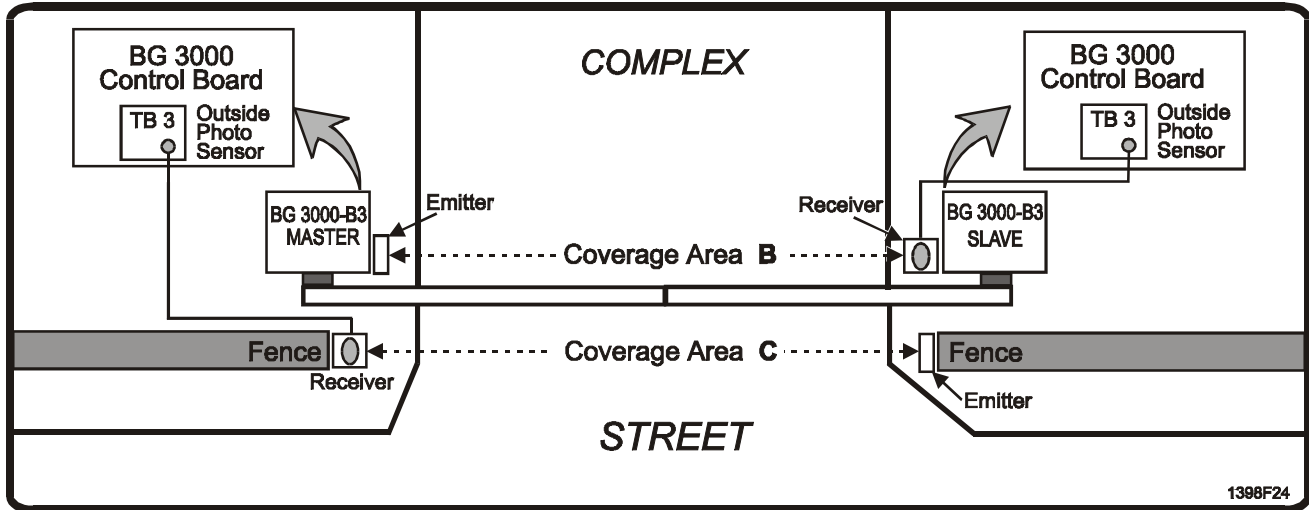

Figure 8. Biparting Barrier Gates Photo-Sensor Layout.

WARNING

Buy only UL-approved photo-sensors made for use with vehicular gate operators or system. Otherwise, safe gate operation may be compromised.

IMPORTANT NOTE: The installation shown in Figure 8 above is a suggested layout using emitters and receivers. Any UL-approved photo-sensors are acceptable, **but they must cover the entire area of gate travel to be effective.**

Install photo-sensors in three **Coverage Areas** as shown in Figure 8.

1. **Coverage Area A** - Inside-Open Coverage: **not needed in barrier gate installation.**
2. **Coverage Area B** - Inside-Closed Coverage:
Install one photo-sensor: Inside the fence line, from the Master gate operator to the Slave gate operator.
3. **Coverage Area C** - Outside-Closed Coverage:
Install one photo-sensor: Outside the fence line, from one fence edge to the other.
4. Connect the photo-sensors to whichever unit is most convenient. For wiring instructions, see Section C, Connecting Input Wiring, below.

B. PHOTO-SENSOR INSTALLATION FOR TRAP/TANDEM GATE CONFIGURATION

Photo-sensors must be installed on each gate separately. For instructions see the Installation and Operation Manual for the gates.

C. CONNECTING INPUT WIRING

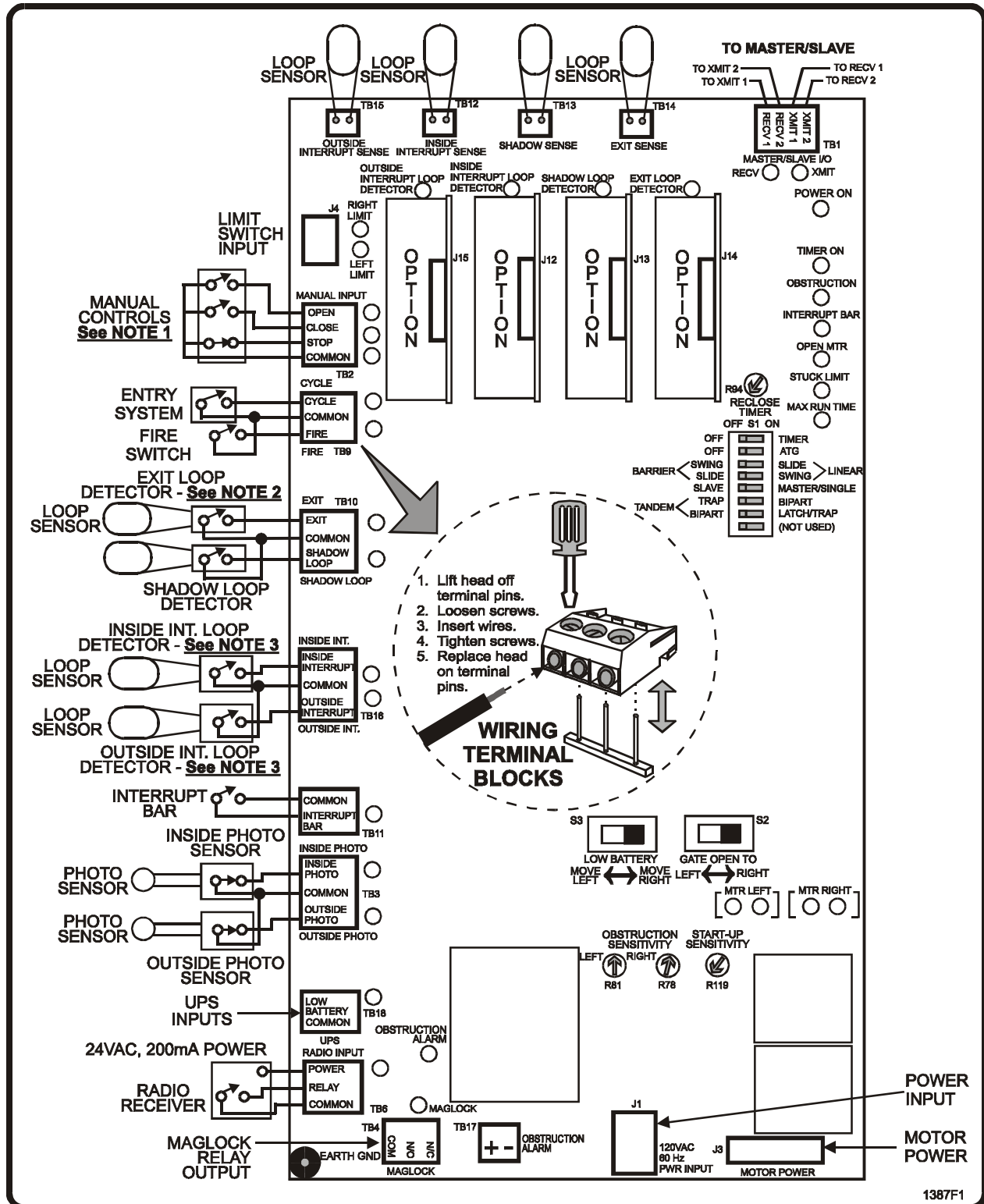

Figure 9. Control Board Wiring.

IMPORTANT
Before proceeding, see NOTES on the next page.

NOTES

1. Disconnecting the STOP terminal from the COMMON terminal stops the gate and prevents all commands from having any effect. Manual Open does not activate the Reclose Timer.
2. If gate(s) are used for bi-directional traffic, the Exit Loop should be a directional loop detector.
3. Inside and Outside Interrupt Loops:
 - ◆ For maximum safety, Inside and Outside Interrupt loops require separate loop detectors.
 - ◆ **Bipart or Bipart Latch:** If only one loop detector is used, the Outside loop must also be connected to the Inside loop detector.

INPUTS:

MasterSlave I/O (TB1) Input/output terminals are used for communication between Master and Slave gate operators (see Section B below).

INDICATORS:

XMIT Indicates data is being sent to the other gate operator (Master or Slave).

RECV Indicates data is being received from the other gate operator (Master or Slave).

CONTROLS (S1):

NOTE: Both gates must be set to same gate type (SLIDE, SWING, BARRIER, or LINEAR). See the Installation and Operation manual for the specific gate, Part 2 System Installation, Section J Setting Gate Control Switch S1 for proper settings.

MASTER (S1-5) Sets the gate to MASTER (right) or SLAVE (left).

BIPART (S1-6) In conjunction with the switch S1-7, sets configuration for master/slave system (see Section F below).

LATCH/TRAP (S1-7) In conjunction with the switch S1-6 switch, sets configuration for master/slave system (see Section F below).

D. MASTER/SLAVE INTERCONNECTION

- A conduit between the Master and Slave units should be provided for the Master/Slave interconnection cable.
- Two shielded twisted pair wire 16 AWG to 24 AWG will be connected between the two units at TB1 on the controller Board

NOTES:

1. Do not run the Master/Slave cable and AC power wires in the same conduit.
2. Master/Slave interconnection cable should not exceed 3000 feet in length.

E. MASTER/SLAVE WIRING

1. Select the desired gate layout in Section G.
2. Be sure to turn off BOTH gate operator units.
3. Wire all external control devices to their connection on the control board shown. See the Installation and Operation instructions for the gate operators, Appendix A for details on how each control input affects the gate operator.
4. Connect the Master/Slave interconnect cable: connect the Receive inputs (RECV1, RECV2) on each board to the Transmit inputs (XMIT1, XMIT2) on the other board (see Figure 10).
5. Turn on power to the Slave gate operator.
6. Turn on power to the Master gate operator.
7. Set switch S1 on Master and Slave units to your configuration according to section F.
8. Perform the Post Assembly Procedure and the Final Assembly of Gate Operator instructions, as found in Part 2 of the Installation and Operation instructions for the gate operators.

NOTE

Be sure to connect the two units correctly. Improper wiring of the Master/Slave interconnection prevents proper operation of the system.

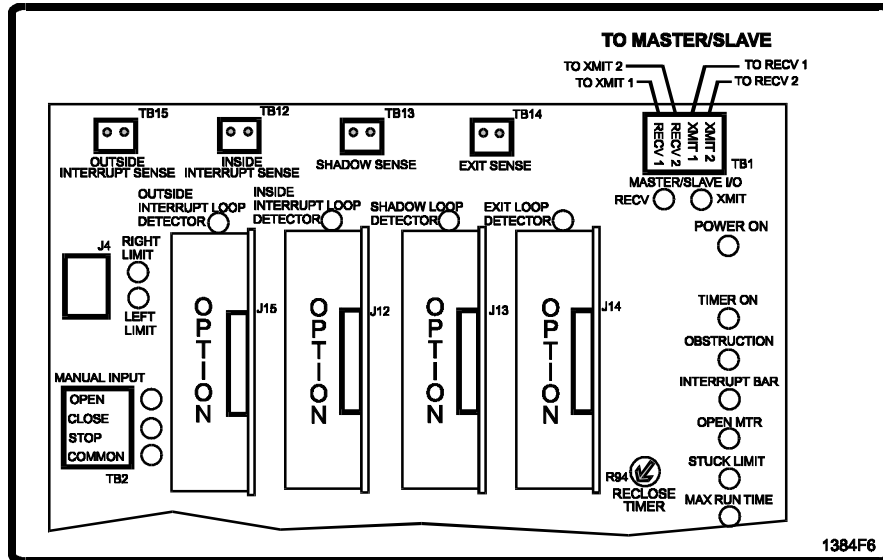

Figure 10. Master Slave Connection and Switch S1 Location.

F. SWITCH S1 MASTER SLAVE CONFIGURATIONS AND GATE CONTROLS SETTINGS:

MASTER/SLAVE CONFIGURATIONS:

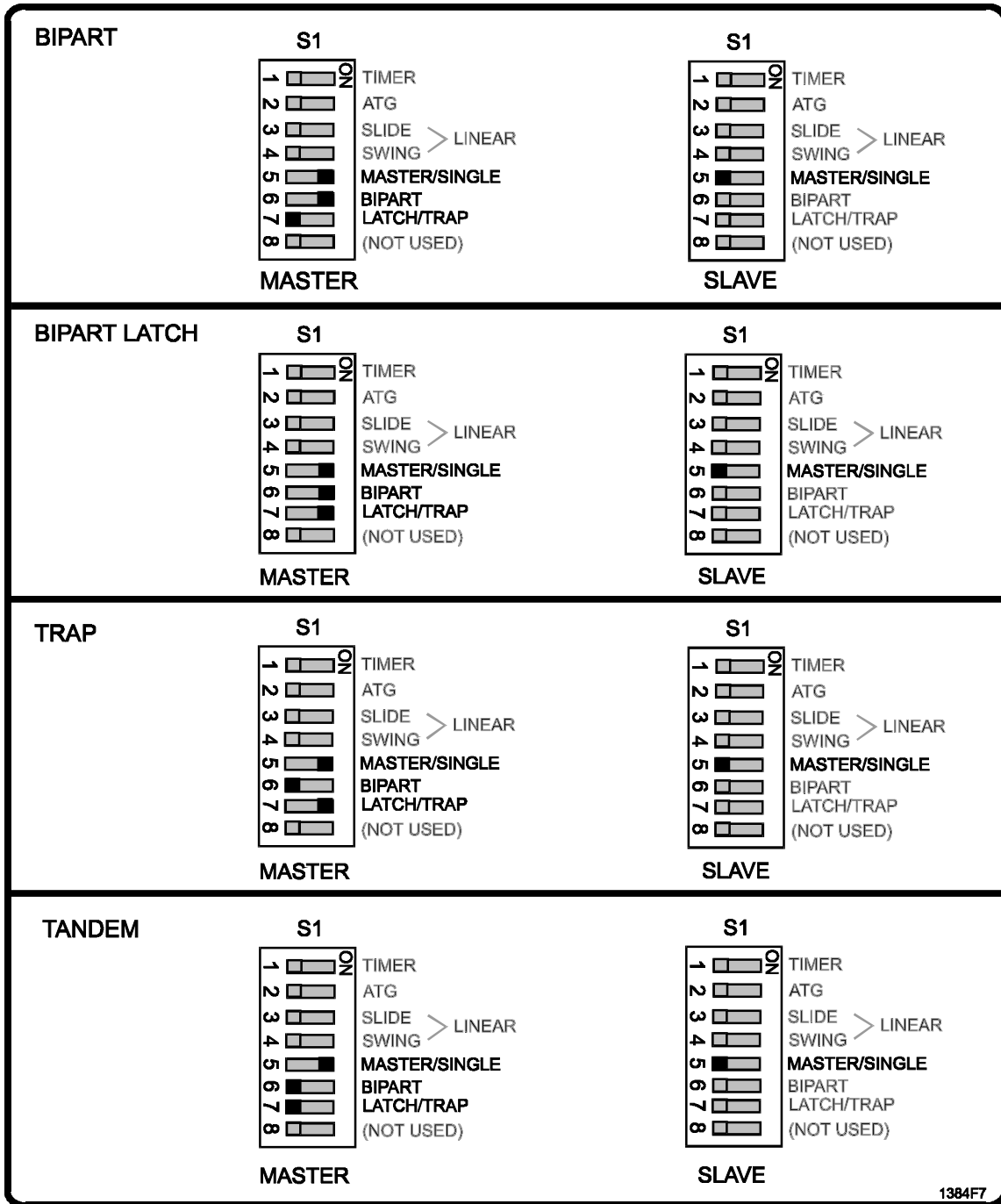

Figure 11. Switch S1 Settings for Master/Slave Systems.

G. SYSTEM LAYOUTS AND CONTROL WIRING

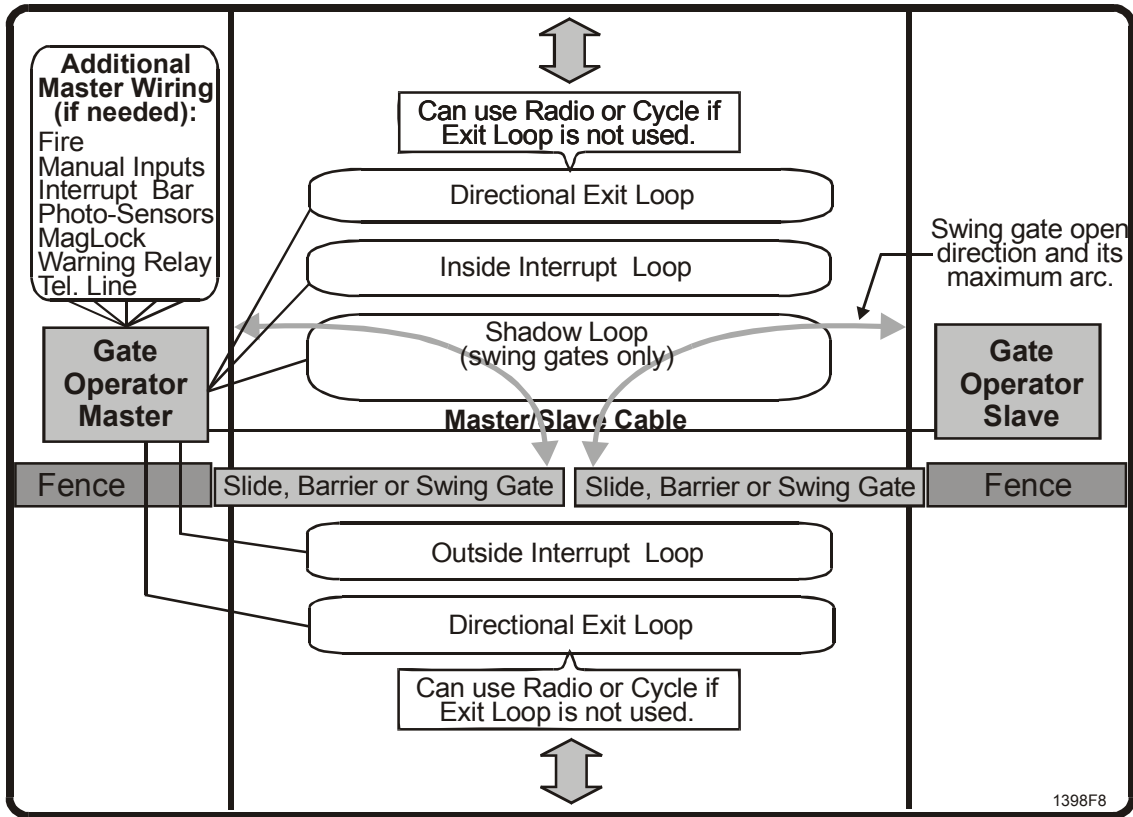

Figure 12. Bi-Part, Bi-Directional Gate System.

NOTE: If Radio is used, only one receiver/transmitter is required for both directions.

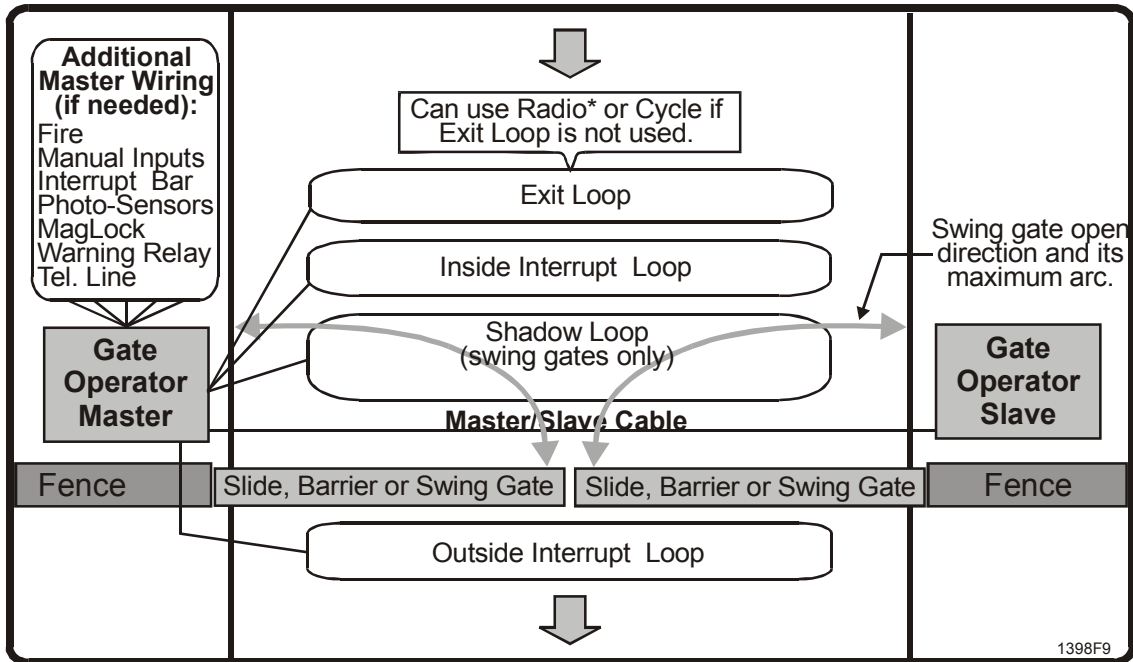

Figure 13. Bi-Part, Uni-Directional Gate System (Swing gate, if used, opens in).

*** WARNING**

If Radio is used, gate system becomes bi-directional, compromising safety and security.

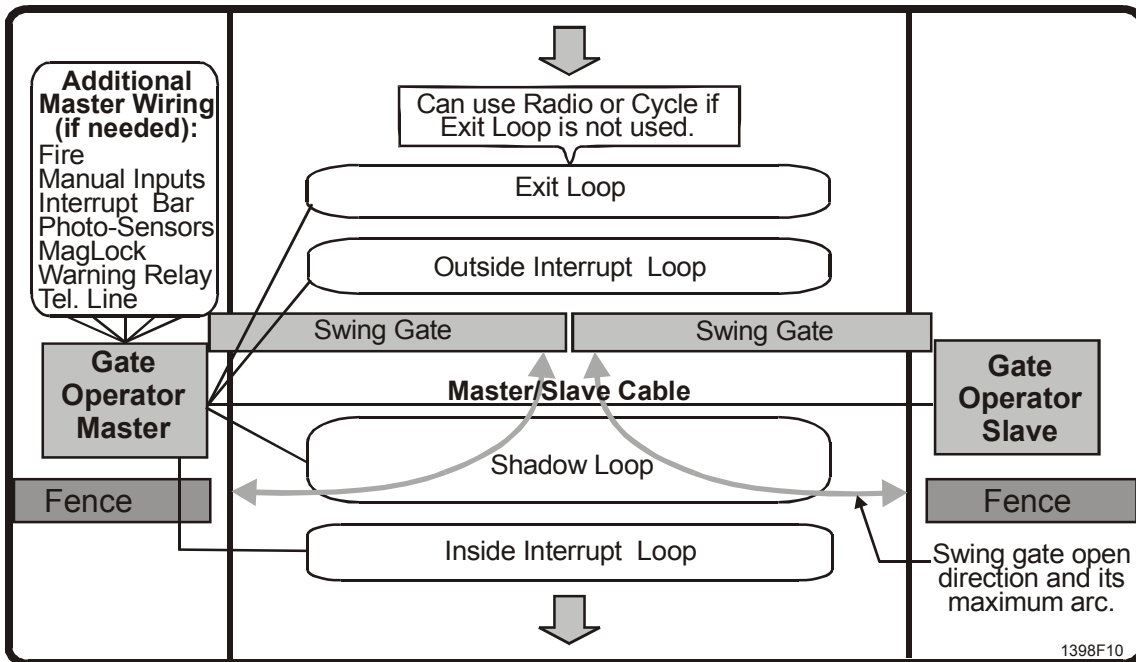

Figure 14. Bi-Part, Uni-Directional Gate System (Swing gate opens out).

*** WARNING**

If Radio is used, gate system becomes bi-directional, compromising safety and security.

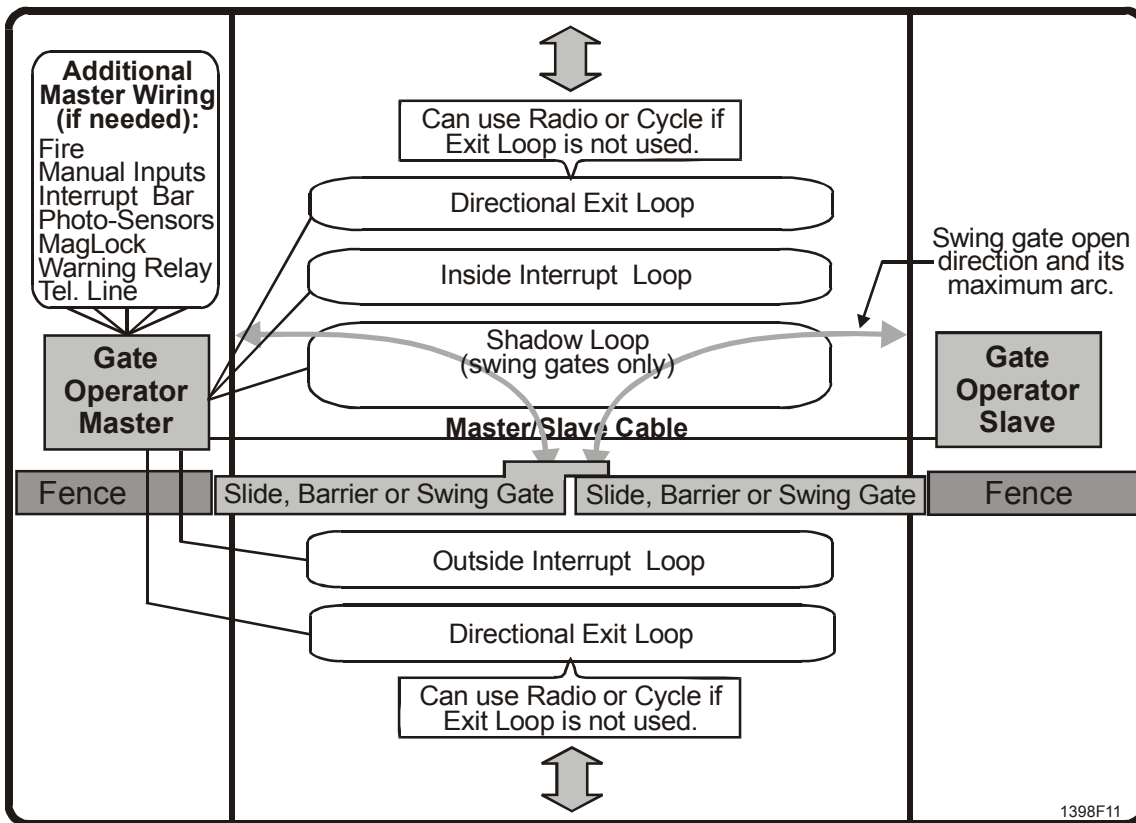

Figure 15. Bi-Part, Bi-Directional Gate System.

NOTE: If Radio is used, only one receiver/transmitter is required for both directions.

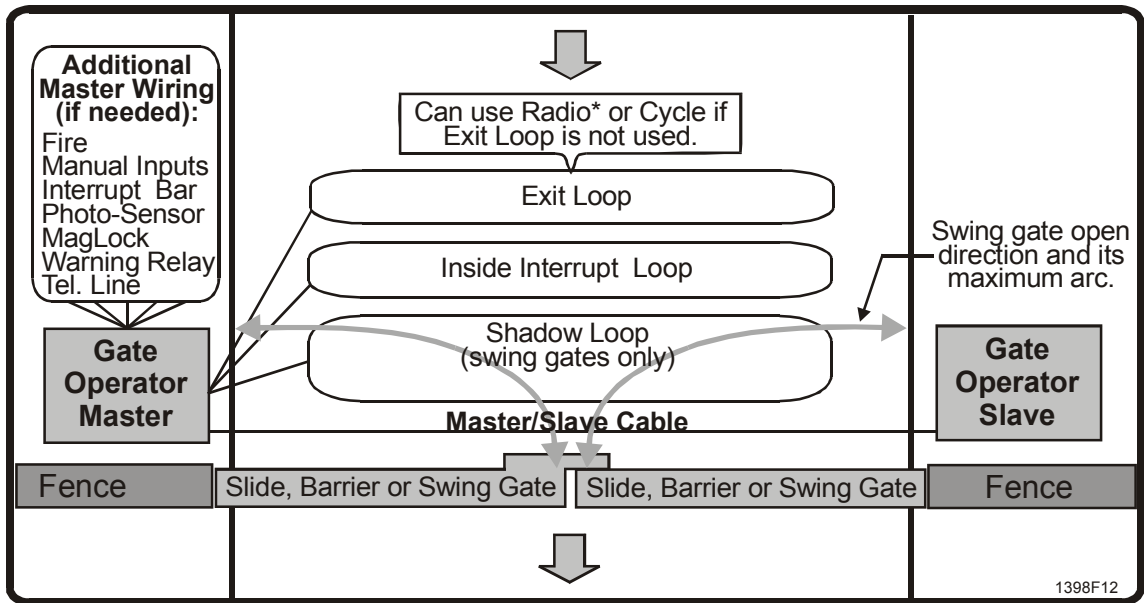

Figure 16. Bi-Part Latch, Uni-Direction Gate System (Swing gate, if used, opens in).

*** WARNING**
 If Radio is used, gate system becomes bi-directional, compromising safety and security.

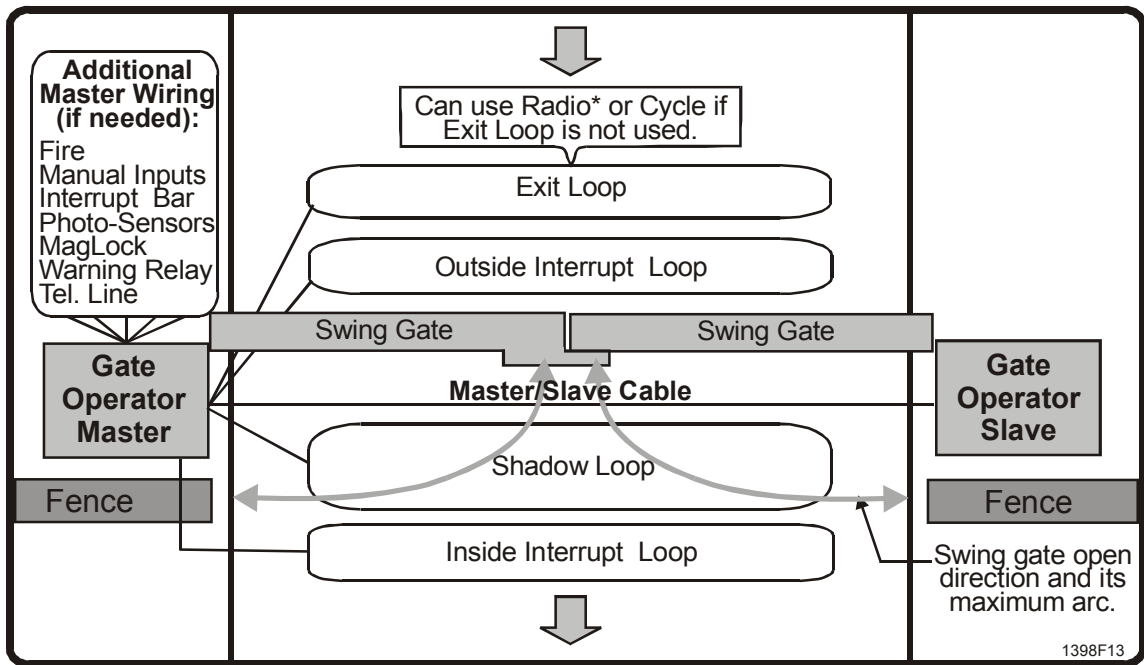

Figure 17. Bi-Part Latch, Uni-Directional Gate System (Swing gate opens out).

*** WARNING**
 If Radio is used, gate system becomes bi-directional, compromising safety and security.

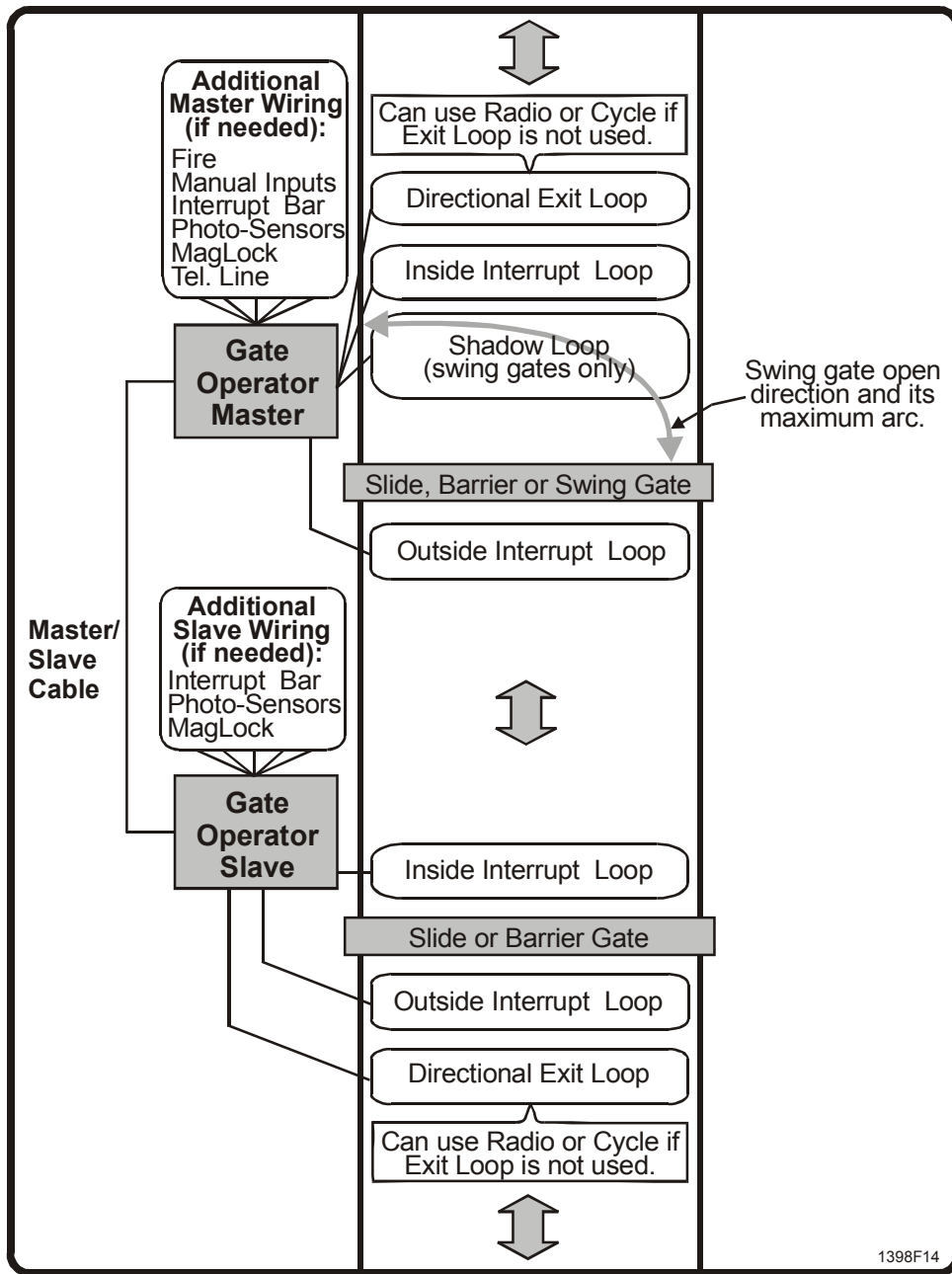
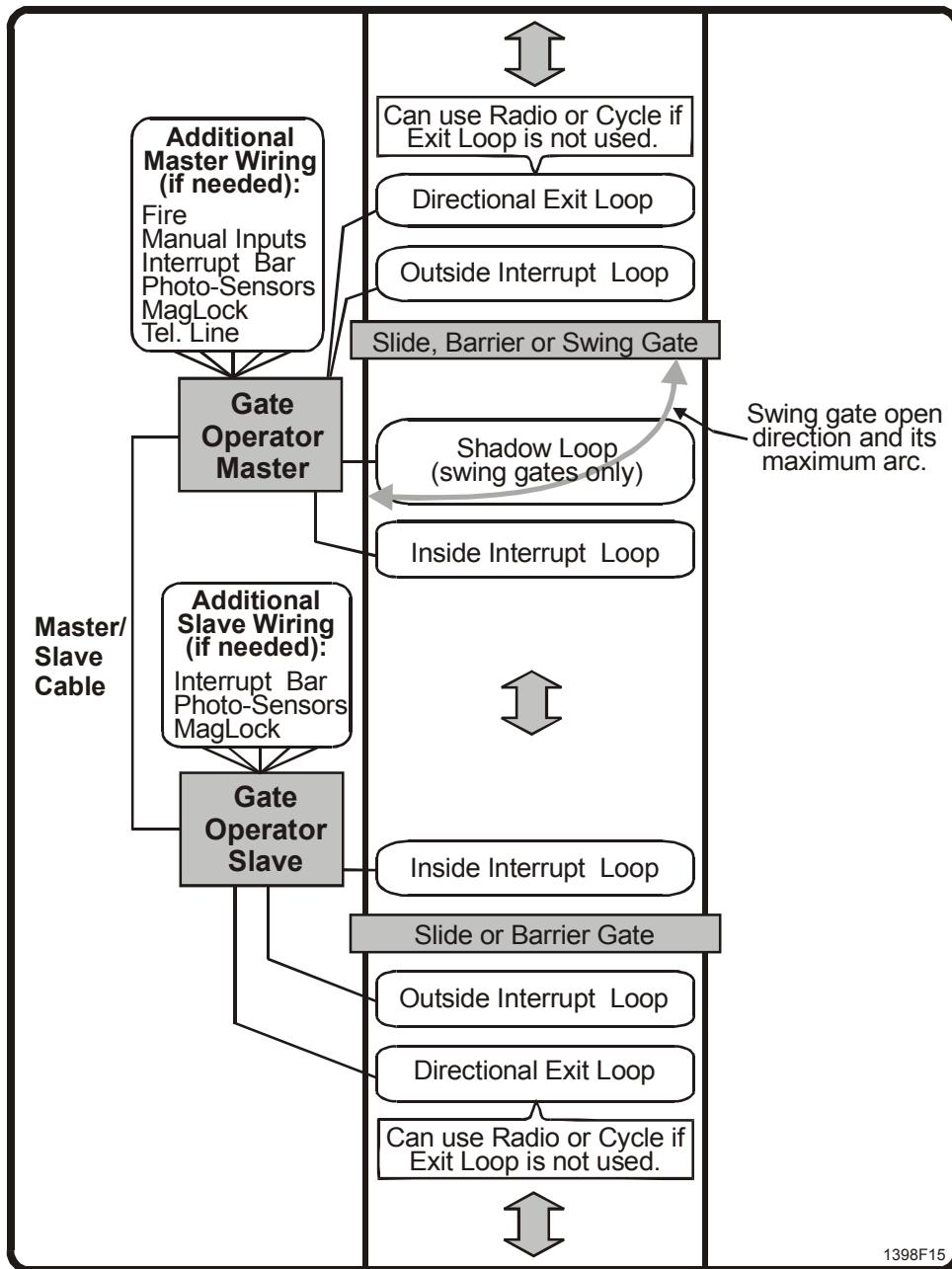

Figure 18. Bi-Directional Trap Gate System (Swing Gate, if used, opens in).

NOTE: If Radio will be used in both gates, each gate will require a separate receiver/transmitter with a separate entry code.



**Figure 19. Bi-Directional Trap Gate System
(Swing gate opens out).**

NOTE: If Radio will be used in both gates, each gate will require a separate receiver/transmitter with a separate entry code.

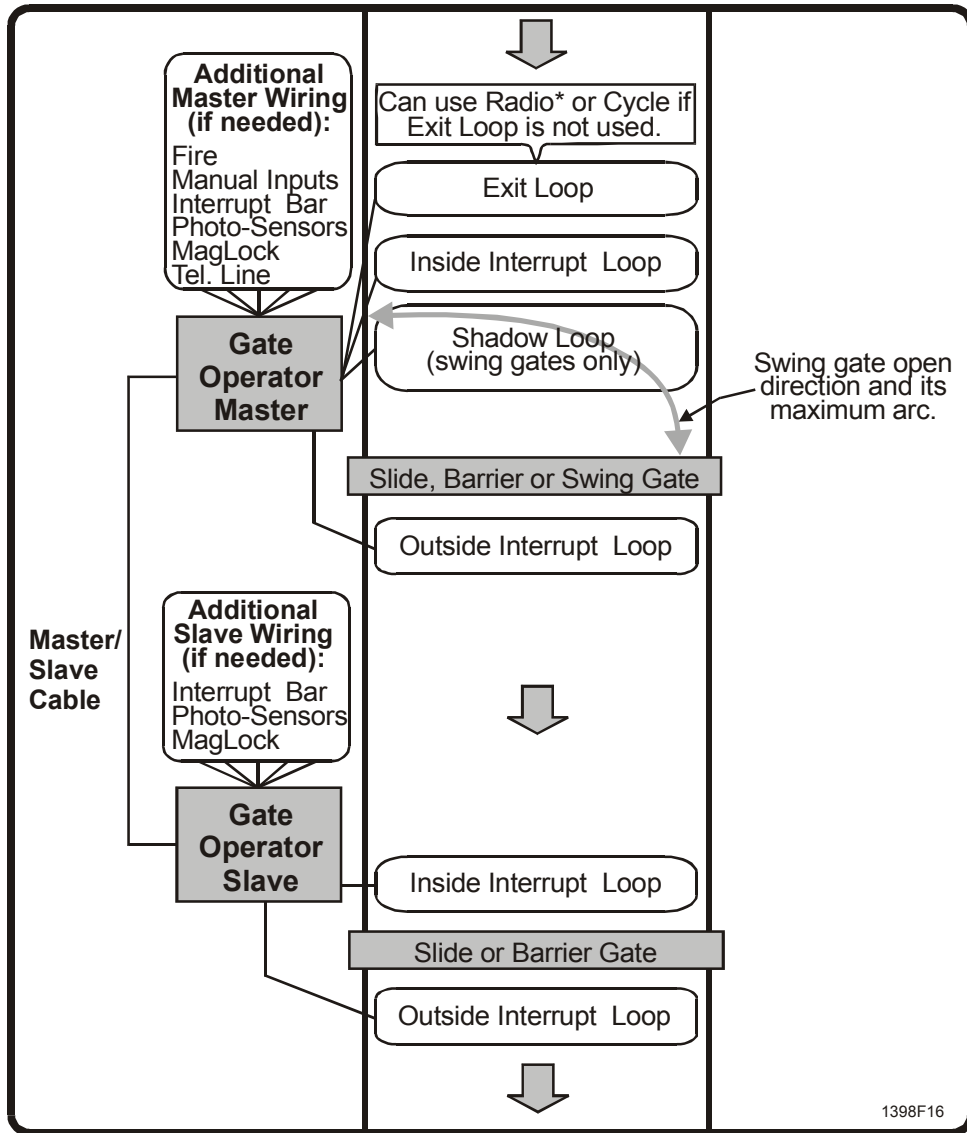

**Figure 20. Uni-Directional Trap Gate System
(internal Swing gate, if used, opens in).**

*** WARNING**

If Radio is used, gate system becomes bi-directional, compromising safety and security.

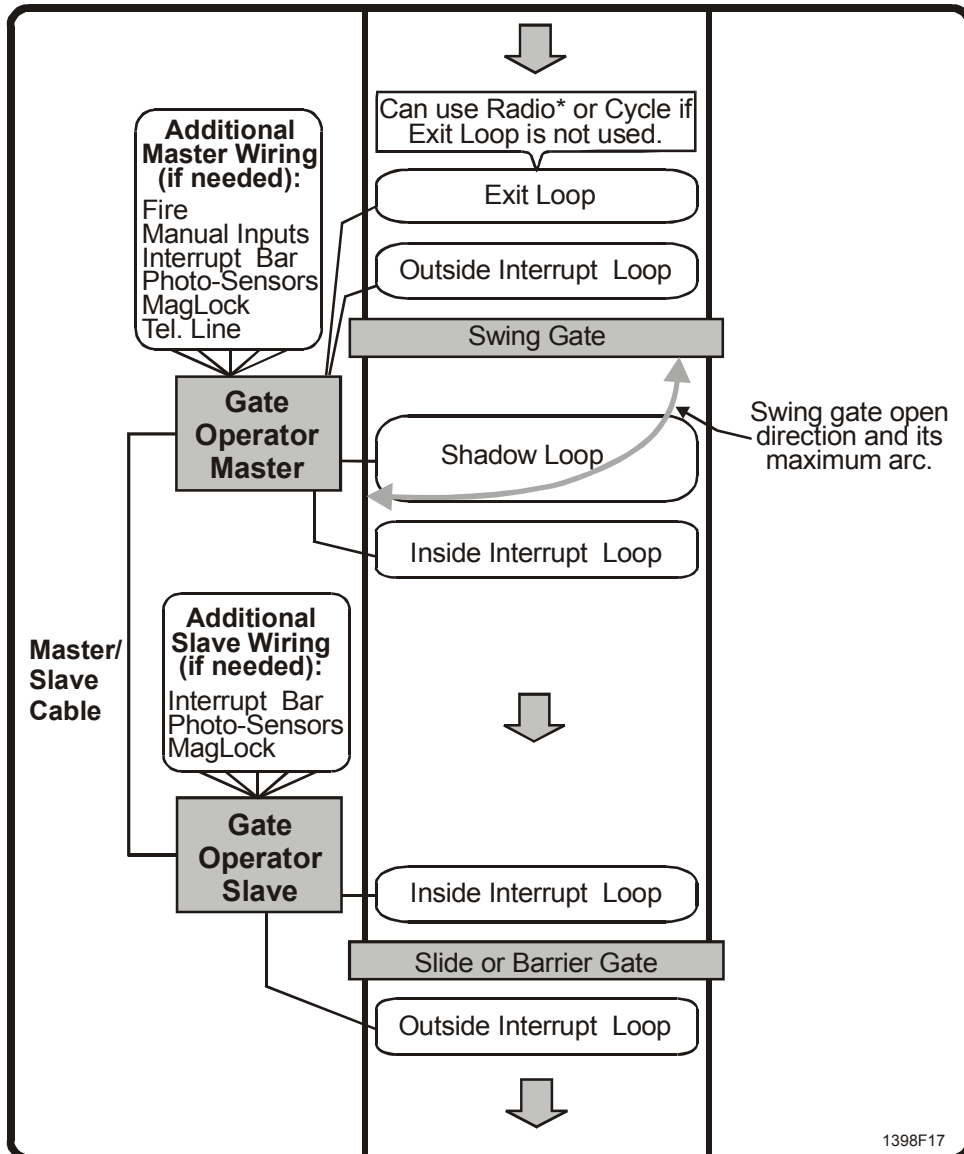

**Figure 21. Uni-Directional Trap Gate System
(internal Swing gate opens out).**

*** WARNING**

If Radio is used, gate system becomes bi-directional, compromising safety and security.

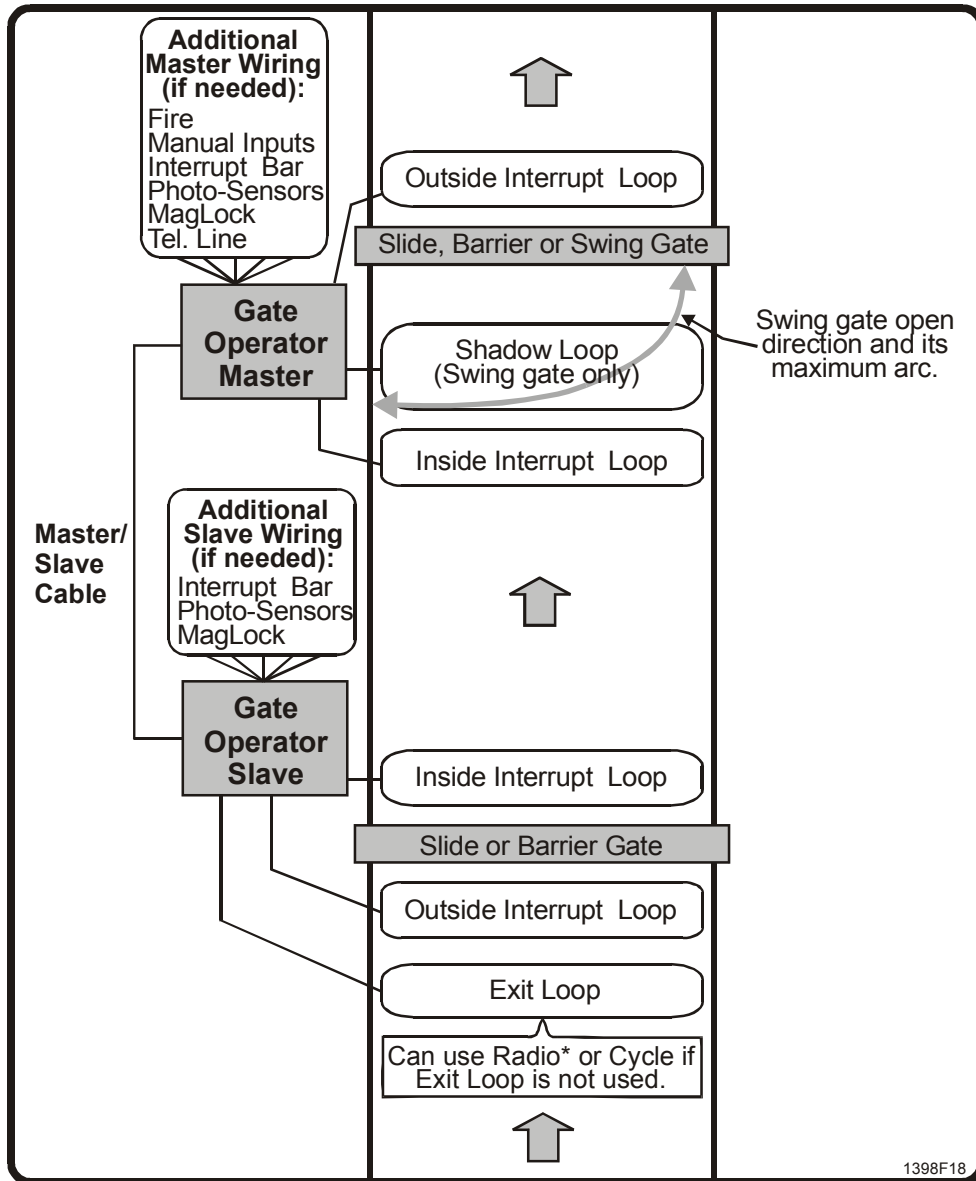

Figure 22. Uni-Directional Trap Gate System (external Swing gate, if used, opens in).

*** WARNING**

If Radio is used, gate system becomes bi-directional, compromising safety and security.

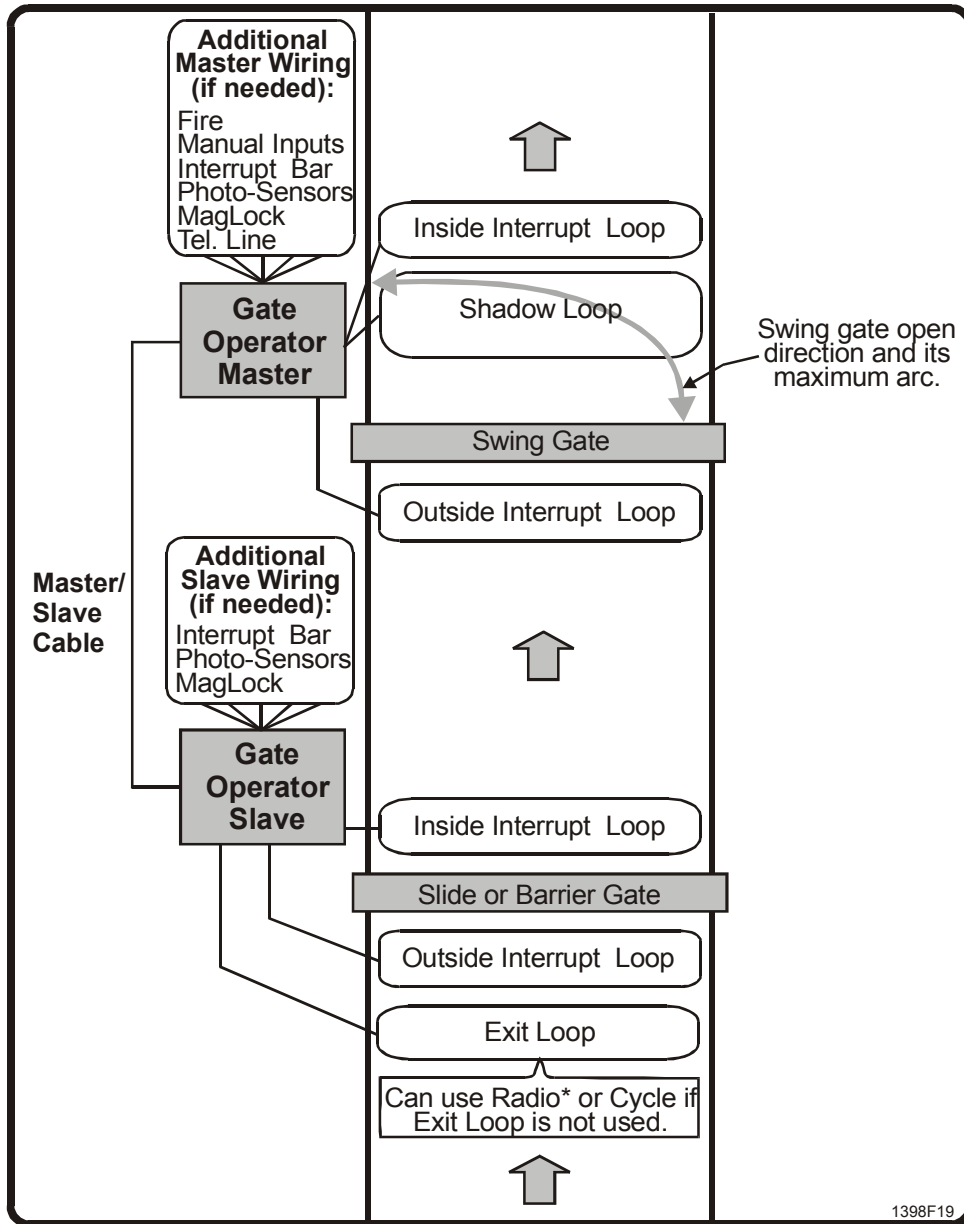

Figure 23. Uni-Directional Trap Gate System (external Swing gate opens out).

*** WARNING**
 If Radio is used, gate system becomes bi-directional, compromising safety and security.

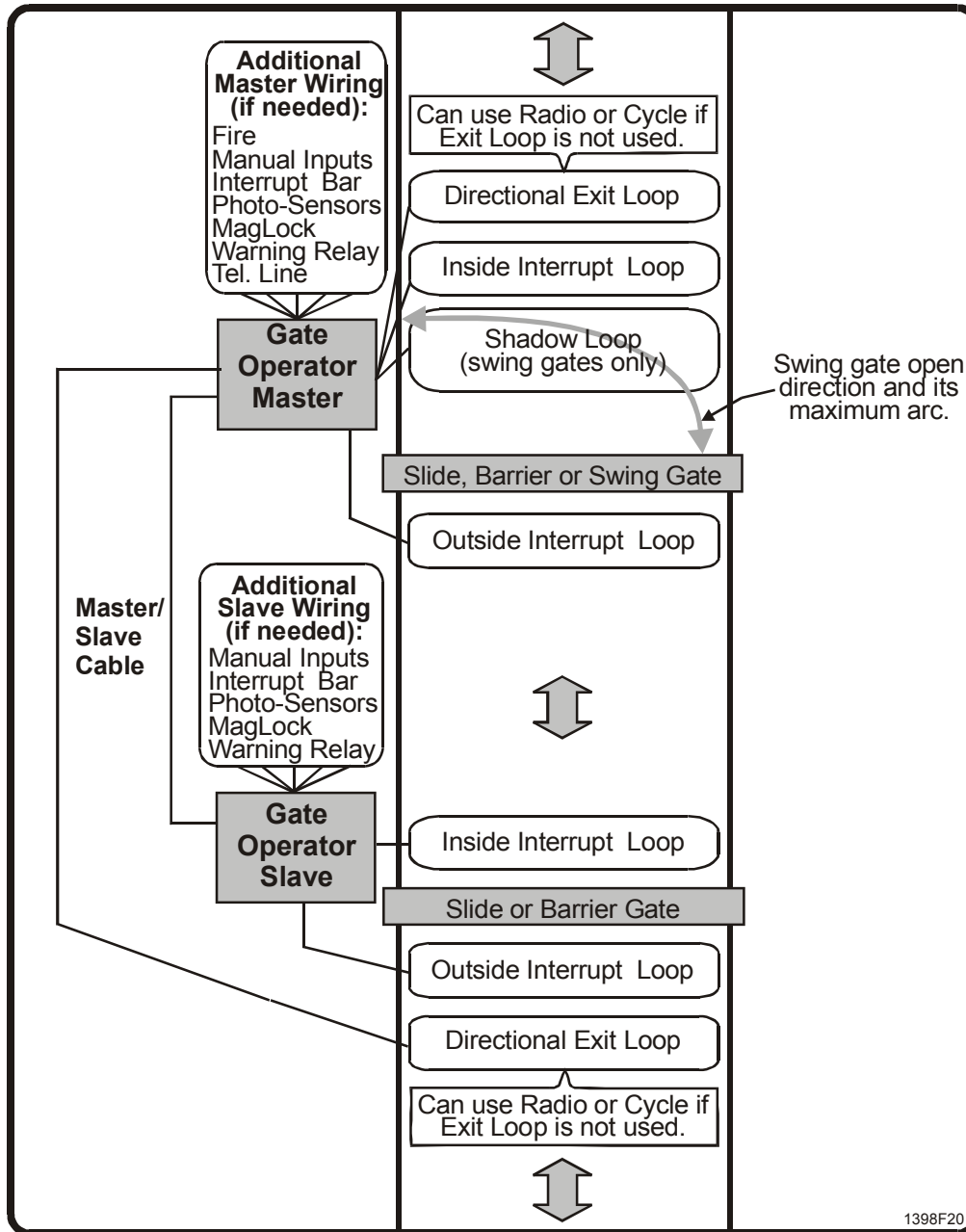
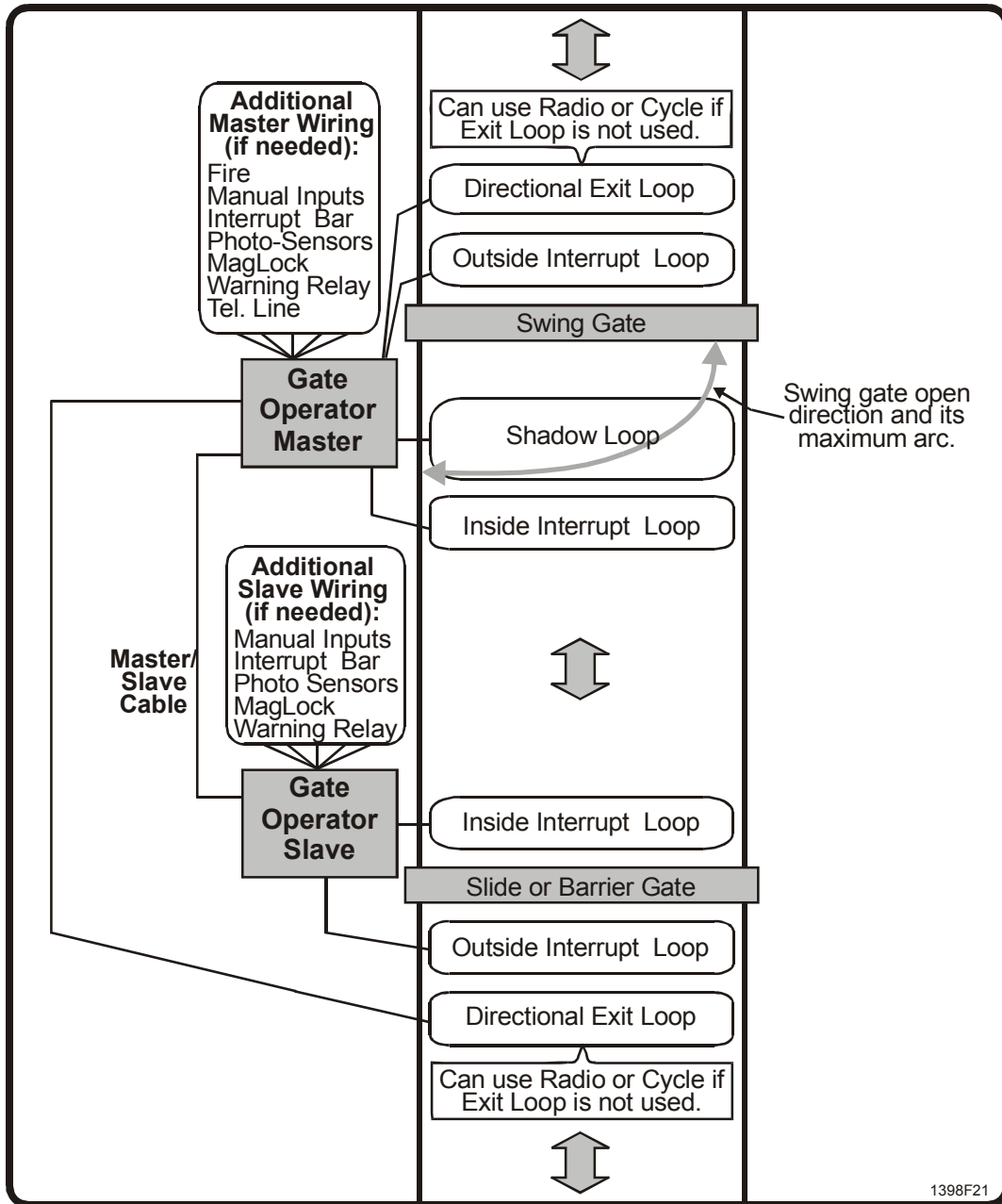

Figure 24. Bi-Directional Tandem Gate System (Swing gate, if used, opens in).

NOTE: If Radio is used, only one receiver/transmitter is required for both directions.



**Figure 25. Bi-Directional Tandem Gate System
(Swing gate opens out).**

NOTE: If Radio is used, only one receiver/transmitter is required for both directions.

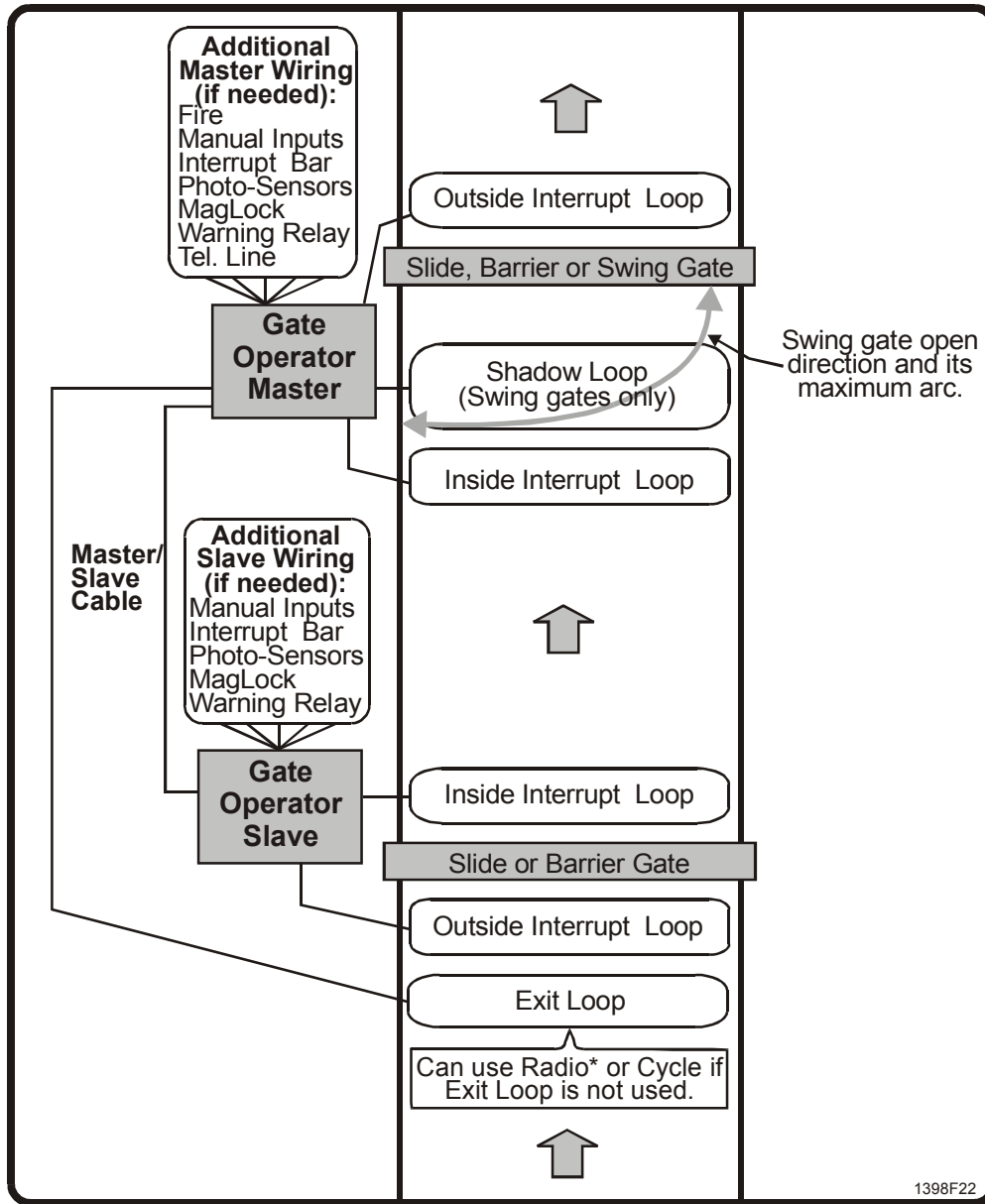

Figure 26. Uni-Directional Tandem Gate System (Swing gate, if used, opens in).

*** WARNING**

If Radio is used, gate system becomes bi-directional, compromising safety and security.

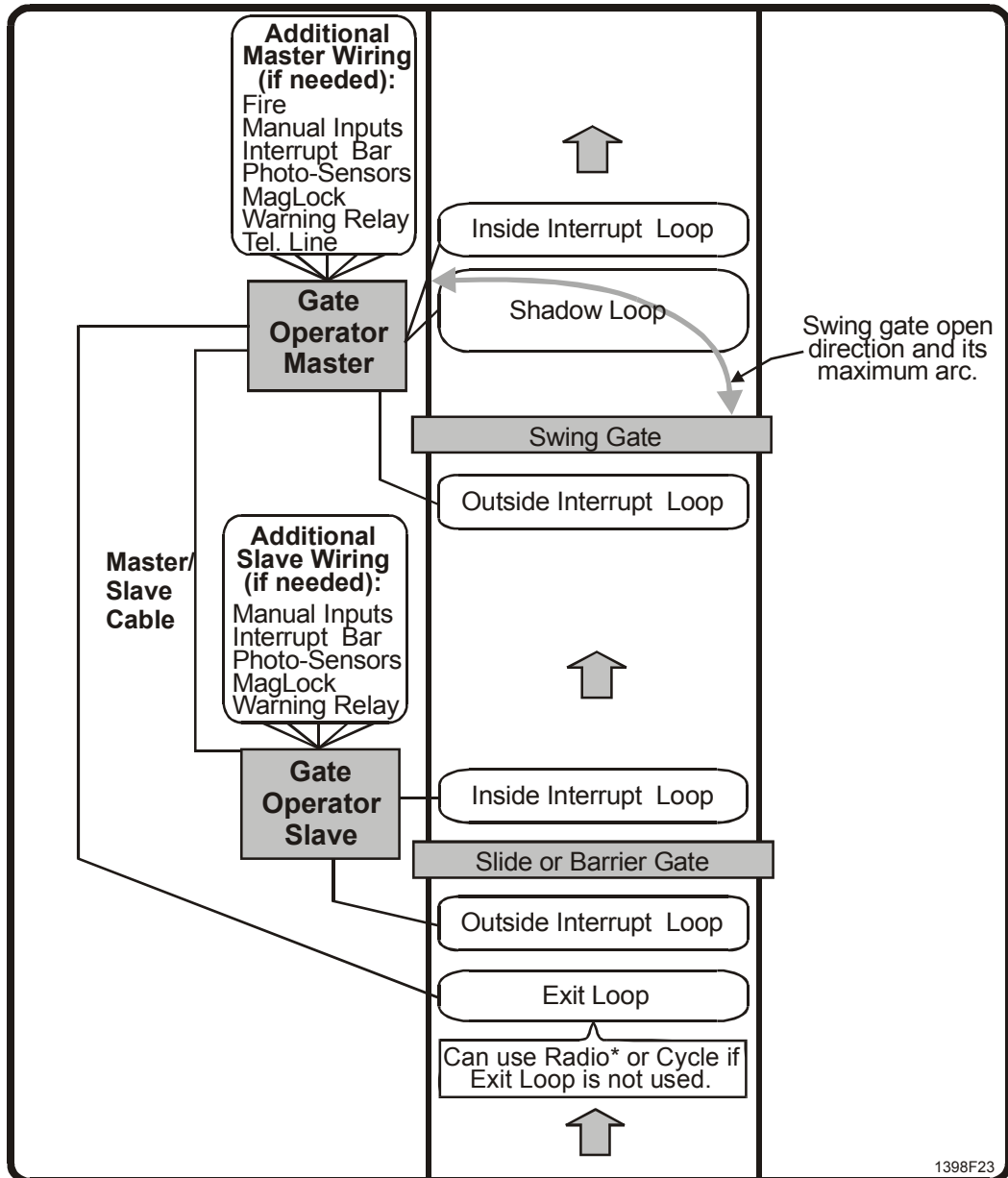

Figure 27. Uni-Directional Tandem Gate System (Swing gate opens out).

*** WARNING**
 If Radio is used, gate system becomes bi-directional, compromising safety and security.

H. TROUBLESHOOTING

Units work as stand-alone:

1. Miswired or disconnected Master/Slave interconnect cable.
2. Improper Master/Slave switch S1 setting.
3. Bad Control board.

Units are not synchronized:

Improper Operator Pair setting. See programming step 02, Operator Type.

One gate braking to stop causes a fault in the other (moving) gate:

1. Both units are wired to the same circuit breaker.
2. Undersized power wires.

FCC REQUIREMENTS

INSTALLATION

When you are ready to install this system, call your telephone company and give them the following information:

1. The telephone number of the line to which you will connect the system.
2. The FCC registration number for the system, which is **DS83E7 - 17196 - ALE**.
3. The ringer equivalence number (REN) which is **0.1B**.

This system connects to the telephone line by means of a standard jack called the USOC RJ11C. If this type of jack is not available where you want to install the system, you will need to order it from the telephone company.

TYPE OF SERVICE

Your LiftMaster operator is designed to be used on standard-device telephone lines. They should not be used on coin service or party lines. If you have any questions about your telephone line, such as how many pieces of equipment you can connect to it, the telephone company will provide this information upon request.

TELEPHONE COMPANY PROCEDURES

The goal of the telephone company is to provide you with the best service it can. In order to do this, it may occasionally be necessary for them to make changes in their equipment, operations, or procedures. If these changes might affect your service or operation of your equipment, the telephone company will give you notice, in writing, to allow you to make any changes necessary to maintain uninterrupted service.

IF PROBLEMS ARISE

If any of your telephone equipment is not operating properly, you should immediately remove it from your telephone line, as it may cause harm to telephone network. If the telephone company notes a problem, they may temporarily discontinue service. When practical, they will notify you in advance of this documentation. If advance notice is not feasible, you will be notified as soon as possible. When you are notified, you will be given the opportunity to correct the problem and informed of your right to file a complaint with the FCC.

In the event that any repairs are ever needed on your system, they should be performed only by an authorized representative of LiftMaster, Inc.

DISCONNECTION

If you should ever decide to permanently disconnect your operator from its present line, please call the telephone company and let them know of this change.

RADIO FREQUENCY

This equipment has been tested and found to comply with the limits for a Class B digital device, pursuant to part 15 of the FCC Rules. These limits are designed to provide reasonable protection against harmful interference when the equipment is operated in a residential environment. This equipment generates, uses, and can radiate radio frequency energy and, if not installed and used in accordance with the instruction manual, may cause harmful interference to radio communications. However, there is no guarantee that interference will not occur in a particular installation. If this equipment does cause harmful interference to radio or television reception, which can be determined by turning the equipment off and on, the user is encouraged to try to correct the interference by one or more of the following measures:

1. Reorient or relocate the receiving antenna.
2. Increase the separation between the equipment and receiver.
3. Connect the equipment into an outlet on a circuit different from that to which the receiver is connected.
4. Consult the dealer or an experienced radio/TV technician for help.

If necessary, the user should consult the dealer or an experienced radio/television technician for additional suggestions. The user may find the following booklet prepared by the FCC helpful: "How to Identify and Resolve Radio-Television Interface Problems". This booklet is available from the United States Government Printing Office, Washington, D.C., 20402. Stock No. 004-000-00345-4.

NOTICE TO CANADIAN USERS

NOTICE: The Industry Canada label identifies certified equipment. This certification means that the equipment meets telecommunications network protective, operation and safety requirements as prescribed in the appropriate Terminal Equipment Requirements document(s). The Department does not guarantee the equipment to the user's satisfaction.

Before installing this equipment, users should ensure that it is permissible to be connected to the facilities of the local telecommunications company. The equipment must also be installed using an acceptable method of connection. The customer should be aware that compliance with the above conditions may not prevent degradation of service in some situations.

Repairs to certified equipment should be coordinated by a representative designated by the supplier. Any repairs or alterations made by the user to this equipment, or equipment malfunctions, may give the telecommunications company cause to request the user to disconnect the equipment.

For their own protection, users should ensure that the electrical ground connections of the power utility, telephone lines and internal metallic water pipe system, if present, are connected together. This precaution may be particularly important in rural areas.

Caution: Users should not attempt to make such connections themselves, but should contact the appropriate electric inspection authority, or an electrician, as appropriate.

CHAMBERLAIN®

LiftMaster
PROFESSIONAL

COPYRIGHT © 2002
ALL RIGHTS RESERVED

This document is protected by copyright and may not be copied or adapted without the prior written consent of LiftMaster. This documentation contains information proprietary to LiftMaster and such information may not be distributed without the prior written consent of LiftMaster. The software and firmware included in the LiftMaster product as they relate to this documentation are also protected by copyright and contain information proprietary to LiftMaster.

FOR TECHNICAL SUPPORT OR TO ORDER REPLACEMENT PARTS, CALL OUR TOLL FREE NUMBER:

(800) 528-2806 Tucson, AZ Monday thru Friday 5 AM – 6 PM, Saturday, 7 AM – 3:30 PM (PST)

Visit us at www.liftmaster.com