

STAR WARS EPISODE I

ELECTRONIC
 NABOO™ DEFENSE
 GAME



INSTRUCTION

1. THE FINAL BATTLE

Anakin Skywalker is in danger! Armed with only a Naboo blaster, you must take out battle droids, destroyer droids, and STAPs before they reach Anakin's starfighter. Your battle begins inside the hangar where the Queen's starship just landed. Then it's outside to the main plaza where you face a new series of obstacles. Your mission is to give Anakin a clear path to take off so he can reach the Trade Federation droid control ship and fire inside the main reactor. The game will be in first person view. You will not see your character during the gameplay or control your movement between each stage. You will only control the crosshair to lock onto enemies and targets. The directional pad is used to move your crosshair on set targets so you can shoot them.

2. THE BATTLE FIELD

Naboo Defense has six main levels you must battle your way through. Levels 1-3 will take place inside the hangar where the Queen's starship just landed. Levels 4-6 will take place outside the main plaza. With the exception of level 5, each level is broken up into six stages. At the end of each stage you will see your soldier move to the next stage of the level. When you complete all six stages you will advance to the next level. Each battle stage is made up of three screens you can move the crosshair back and forth to lock on and attack the incoming enemies. At the beginning of each stage your crosshair will be displayed on the center screen battlefield. If you move the crosshair to the far left, the screen will scroll to reveal the left side of the battlefield. If you move the crosshair to the far right, the screen will scroll to reveal the right side of the battlefield.

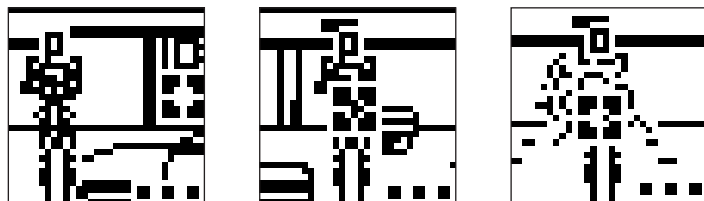

MOVE THE CROSSHAIR LEFT AND RIGHT TO LOCK ON AND DESTROY THE ATTACKING DROIDS!

3. YOUR WEAPON OF CHOICE

Use your Naboo Blaster to destroy the enemies:

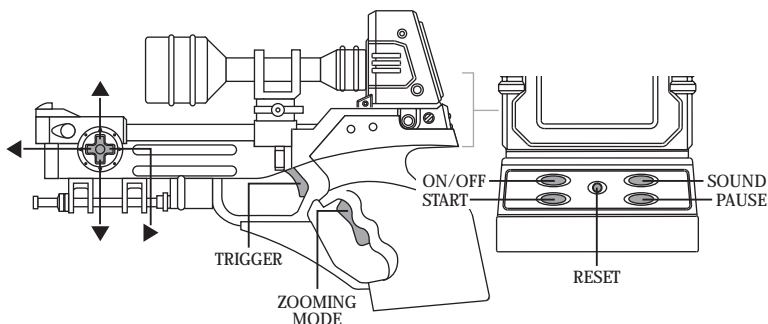

- ON/OFF – to turn the power ON/OFF. (The unit also shuts off automatically after 3 minutes of inactivity.)
- START – to start the game.
- SOUND PAUSE – to turn the sound ON/OFF.
- PAUSE – to pause the game.
- ▲ – to move your crosshair to the Up.
- ▼ – to move your crosshair to the Down.
- ▶ – to move your crosshair Right.
- ◀ – to move your crosshair Left.
- FIRE – to fire your Naboo Blaster.
- ZOOMING MODE – to zoom in 2x in the background and to zoom out.
- RESET – to reset the unit if your game malfunctions.

4. THE BATTLE BEGINS

Press the POWER button to turn on the unit. The unit will then display the Star Wars logo and then the Naboo Defense title on the screen.

Press the START button to begin your attack inside the hangar! At the start of the game you have a life bar meter, which is made up of three sections located in the lower right-hand corner of the screen. Each time you take a hit from a droid you lose one section of your life bar meter. If you lose all three, you will lose a life. You start with one soldier on screen and two in reserve. If you lose all three the game is over and you fail the mission.

Throughout the stages you can find random health icons hidden in crates to gain one section of your life bar meter back. Your life bar meter can hold a total of five health icons but you will only start out with three. To pick up extra health, you must move the crosshair and shoot at the crate to first expose the heart icon. Once the heart icon is exposed, shoot it to add it to your life bar meter.

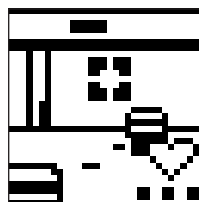

SOME CRATES IN THE BACKGROUND CONTAIN EXTRA HEALTH! SHOOT THEM TO EXTEND YOUR LIFE BAR METER!

5. KNOWING YOUR ENEMIES

Battle droids, battle droids on STAPs and destroyer droids are the main enemies that constantly plague the levels in the game. Most of the enemies will randomly appear on the screen and move left and right. Sometimes they will appear behind crates and others will jump down at you. All the droids in the game have priority attack levels. Meaning not every enemy in the game will be able to shoot and hit you as soon as they appear on the screen. Your goal is to find and take out the more dangerous droids first, then go for the less threatening droids. Each enemy in the game will take two or three shots to destroy.

BATTLE DROIDS

The battle droids are slow moving and take the longest to fire at you. They can remain stationary, move left and right, jump down from above or charge in from the background. When a battle droid appears on the screen you have a few seconds before they will shoot at you. This will give you a few moments to destroy more hostile enemies that are about to attack.

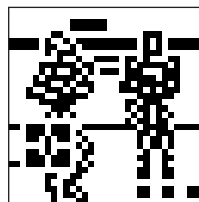

BATTLE DROIDS ARE NOT THE STRONGEST DROIDS IN THE GAME BUT THEY ATTACK IN LARGE NUMBERS!

BATTLE DROIDS ON STAPS

The battle droids on STAPs move at a faster rate than the walking droids and their reaction time to firing is a little quicker. STAPs can fly left and right or hover in one position. If a droid on a STAP and a walking battle droid appear at the same time, your best bet is to take out the STAP and then destroy the walking battle droid. You should have enough time to take out both without getting hit.

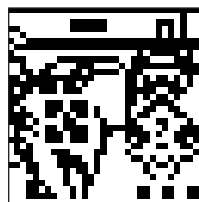

WHEN A STAP STOPS MOVING OR DIRECTLY FACES THE SCREEN IT WILL BEGIN TO FIRE AT YOU!

DESTROYER DROIDS

The destroyer droids are the fastest moving and attacking droids you will face. They will fire at you instantly when they appear and stop moving on screen. They can appear in both wheel and in walking form. Destroyer droids can roll and walk left and right. They can also appear in the background and hide behind obstacles. The destroyer droids should be your first priority, as soon as they appear on the screen, attack them with speed and accuracy.

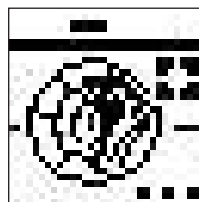

THE DESTROYER DROIDS WILL NOT ATTACK IN WHEEL FORM. THIS IS YOUR BEST CHANCE TO TAKE THEM OUT BEFORE THEY UNFOLD AND ATTACK!

ZOOMING MODE

All the droids can either appear in the foreground or in the background. If an enemy appears in the background you can't shoot them in normal viewing mode. The only way to shoot them is by using the 2-Zoom Mode. You must press the 2-Zoom rocker switch, which will quickly give you a close up view of the background and your enemy.

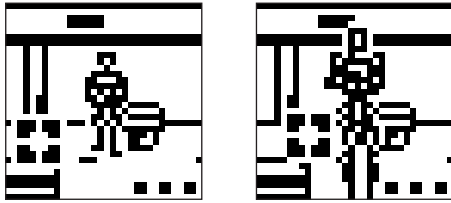

WHEN A DROID APPEARS IN THE BACKGROUND, PRESS THE 2-ZOOM ROCKER SWITCH TO GET IN CLOSE AND DESTROY IT!

FIGHTING THE END BOSSES

There are two End Bosses you must defeat to complete your mission. The first End Boss is at the end of level 3 and the second one is at the end of level 6. You must first destroy the level 3 End Boss before you can complete level 3 and reach the main plaza in level 4. You must then destroy the level 6 End Boss to win the game. Each End Boss will require several shots at key locations to destroy them. When attacking an End Boss, if your shot makes a high pitch sound effect, this means the End Boss is taking damage. You must continue to shoot it at that same locations until you hear an explosion sound effect and see damage appear on that section of the End Boss. When all the sections are destroyed the End Boss will be defeated.

TRADE FEDERATION STARFIGHTER

The starfighter level 3 End Boss appears at the end of the hanger and is in walking mode. To destroy the starfighter you must first destroy its four wings. Each wing will take 15 shots to completely destroy them. After you destroy the wings you must then shoot the nose of the starfighter 20 times. While you are trying to destroy the starfighter it will also fire at you. The starfighter will only fire one shot at a time and will move quickly around the screen making it difficult for you to lock onto the sections of the wings you need to take it out. Once the starfighter is destroyed it's onto level 4.

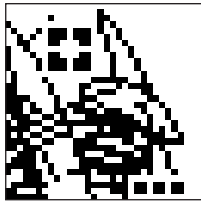

ONCE YOU LOCK ONTO A SECTION OF THE WING THAT CAN BE DESTROYED KEEP FIRING AT IT UNTIL IT EXPLODES!

FEDERATION TANK

The Federation Tank will roll in at the end of level 6. You must destroy the tank so Anakin has a clear path to take off so he can reach the Trade Federation droid control ship and fire inside the main reactor. The Federation Tank will first appear in the far background and then move in closer. You must first take out the two side guns on either side of the tank. Each gun will take 25 shots to destroy. Once you destroy the two side guns you must destroy the main canon. The main canon will take 30 shots to destroy it. The tank will also move around the screen, making it difficult for you to lock onto the two side guns and the main canon.

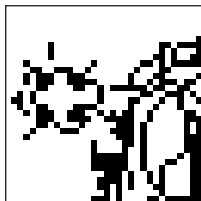

THE FASTER YOU DESTROY THE TWO SIDE GUNS THE LESS DAMAGE THE TANK CAN INFLICT ON YOU, THEN GO FOR THE MAIN CANON!

6. INSERTING THE BATTERIES

To insert the batteries, have an adult open the battery compartment cover at the bottom of the game unit. (Remove the screw holding the battery door onto the bottom of the game unit and remove the door.)

Insert 4 Alkaline "AA" batteries, LR6 or equivalent making sure to align "+" and "-" as shown.

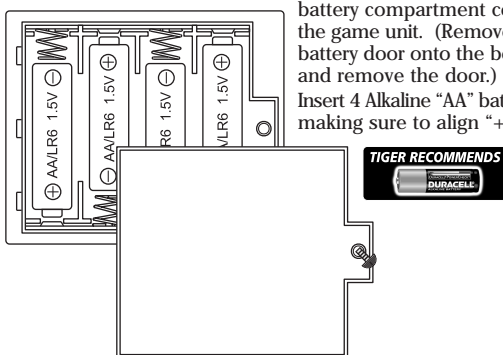

TO ENSURE PROPER FUNCTION :

- DO NOT MIX OLD AND NEW BATTERIES.
- DO NOT MIX ALKALINE, STANDARD (CARBON ZINC) OR RECHARGEABLE BATTERIES.
- BATTERY INSTALLATION SHOULD BE DONE BY AN ADULT.
- NON-RECHARGEABLE BATTERIES ARE NOT TO BE RECHARGED.
- RECHARGEABLE BATTERIES ARE TO BE REMOVED FROM THE TOY BEFORE BEING CHARGED (IF REMOVABLE).
- RECHARGEABLE BATTERIES ARE ONLY TO BE CHARGED UNDER ADULT SUPERVISION (IF REMOVABLE).
- ONLY BATTERIES OF THE SAME OR EQUIVALENT TYPE AS RECOMMENDED ARE TO BE USED.
- BATTERIES ARE TO BE INSERTED WITH THE CORRECT POLARITY.
- EXHAUSTED BATTERIES ARE TO BE REMOVED FROM THE TOY.
- THE SUPPLY TERMINALS ARE NOT TO BE SHORT-CIRCUITED.

RESET BUTTON:

After battery insertion, the RESET switch may be pushed only if the game doesn't work properly.

7. CAUTION/DEFECT OR DAMAGE



High temperature will destroy the unit. Do not leave unit in direct sunlight.

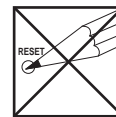

Do not use a pencil or pin to press the RESET switch. Use a ball-point pen.



Do not press the liquid crystal display and avoid heavy shock or the display may fail.



Clean only with a piece of soft dry cloth.

Replace battery at the first sign of erratic operation.

If a part of your ELECTRONIC NABOO DEFENSE GAME is damaged or something has been left out, DO NOT RETURN THE GAME TO THE STORE. The store doesn't have replacement parts. Instead, write to us at:

Tiger Electronics, Ltd. Repair Center
980 Woodlands Parkway,
Vernon Hills, Illinois 60061, U.S.A.

Please include a note with your return explaining the problem along with a sales slip, date, place of purchase and price paid. We will do our best to expedite your return promptly.

8. 90-DAY LIMITED WARRANTY

Tiger Electronics, Ltd. (Tiger) warrants to the original consumer purchaser of this product that the product will be free from defects in materials or workmanship for 90 days from the date of original purchase. This warranty does not cover damages resulting from accident, negligence, improper service or use or other causes not arising out of defects in materials or workmanship.

During this 90-day warranty period, the product will either be repaired or replaced (at Tiger's option) without charge to the purchaser, when returned with proof of the date of purchase to either the dealer or to Tiger.

Product returned to Tiger without proof of the date of purchase or after the 90-day warranty period has expired, but prior to one year from the original date of purchase, will be repaired or replaced (at Tiger's option) for a service fee of U.S.\$19.00. Payments must be by check or money order payable to Tiger Electronics, Ltd.

The foregoing states the purchaser's sole and exclusive remedy for any breach of warranty with respect to the product.

All product returned must be shipped prepaid and insured for loss or damage to:

Tiger Electronics, Ltd. Repair Dept.
980 Woodlands Parkway,
Vernon Hills, Illinois 60061, U.S.A.

The product should be carefully packed in the original box or other packing materials sufficient to avoid damage during shipment. Include a complete written description of the defect, a check if product is beyond the 90-day warranty period, and your printed name, address and telephone number.

THIS WARRANTY IS IN LIEU OF ALL OTHER WARRANTIES AND NO OTHER REPRESENTATIONS OR CLAIMS OF ANY NATURE SHALL BE BINDING ON OR OBLIGATE TIGER IN ANY WAY. ANY IMPLIED WARRANTIES APPLICABLE TO THIS PRODUCT, INCLUDING WARRANTIES OF MERCHANTABILITY AND FITNESS FOR A PARTICULAR PURPOSE, ARE LIMITED TO THE NINETY (90) DAY PERIOD DESCRIBED ABOVE. IN NO EVENT WILL TIGER BE LIABLE FOR ANY SPECIAL, INCIDENTAL, OR CONSEQUENTIAL DAMAGES RESULTING FROM POSSESSION, USE, OR MALFUNCTION OF THIS TIGER PRODUCT.

Some states do not allow limitations as to how long an implied warranty lasts and/or exclusions or limitations of incidental or consequential damages, so the above limitations and/or exclusions of liability may not apply to you. This warranty gives you specific rights, and you may also have other rights which vary from state to state.

For more information about Tiger Electronics, our products and special promotions, please visit our Web Site at: www.tigertoys.com

© Lucasfilm Ltd. & TM. All rights reserved. Used under authorization.

TIGER
ELECTRONICS, LTD.

®, TM, & © 1999 Tiger Electronics, Ltd. All rights reserved.
980 Woodlands Parkway, Vernon Hills, Illinois 60061, U.S.A.

®, TM, & © 1999 Tiger Electronics UK Ltd. All rights reserved.
Belvedere House, Victoria Avenue,
Harrogate, North Yorkshire HG1 1EL, England.
www.tigertoys.com

PRINTED IN CHINA