

FCC Statement:

This equipment has been tested and found to comply with the limits for a Class B digital device, pursuant to part 15 of the FCC Rules. These limits are designed to provide reasonable protection against harmful interference in a residential installation. This equipment generates, uses and can radiate radio frequency energy, and, if not installed and used in accordance with the instructions, may cause harmful interference to radio communications. However, there is no guarantee that interference will not occur in a particular installation. If this equipment does cause harmful interference to radio or television reception, which can be determined by turning the equipment off and on, the user is encouraged to try to correct the interference by one or more of the following measures:

- Reorient or relocate the receiving antenna.
 - Increase the separation between the equipment and receiver.
 - Consult the dealer or an experienced radio/TV technician for help.
- WARNING:** Changes or modifications not expressly approved by the party responsible for compliance could void the user's authority to operate the equipment.

 **x3** 1.5V AA/R6 size
NOT INCLUDED
BATTERIES REQUIRED

Alkaline batteries recommended.
Phillips/cross head screwdriver (not included) needed to insert batteries.

AGES 6+
87625/87623 Asst.

**STAR
WARS**
THE CLONE WARS

ULTIMATE LIGHTSABER
BUILD YOUR OWN LIGHTSABER



The Clone Wars are raging across the galaxy. Join the fight and wield the chosen weapon of the Jedi and the Sith: the lightsaber.

Complete your training by constructing this mystical weapon and reveal which side of the Force you choose in this epic struggle. Construct authentic lightsaber designs or create your own unique designs as often as you wish.

The power of the Force is in your hands!



Not suitable for children under 3 years because of small parts - choking hazard.



Product and colors may vary.
© 2008 Lucasfilm Ltd. & © or TM where indicated. All rights reserved.
®* and/or TM* & © 2007 Hasbro. All Rights Reserved.
TM & © denote U.S. Trademarks.

P/N 6769590000

PARTS I

Hilt

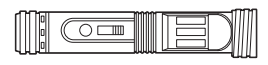

Blade

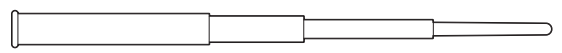

End caps

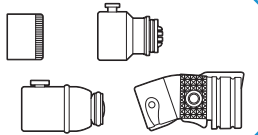

Tonfa handle

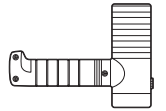

Kyber crystals (3)

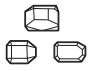

Blade-emitter guard



Hilt sleeves (4)

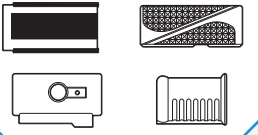

Sleeve rings (3)

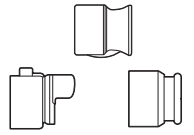

STEP 1

The first step in building a lightsaber is to install the power-generating component.

INSTALLING BATTERIES

Using a Phillips/crosshead screwdriver (not included), loosen screw in door and remove door. Insert 3 x 1.5v "AA" or R6 size batteries (not included) into hilt. Alkaline batteries recommended. Replace battery door and tighten screw.

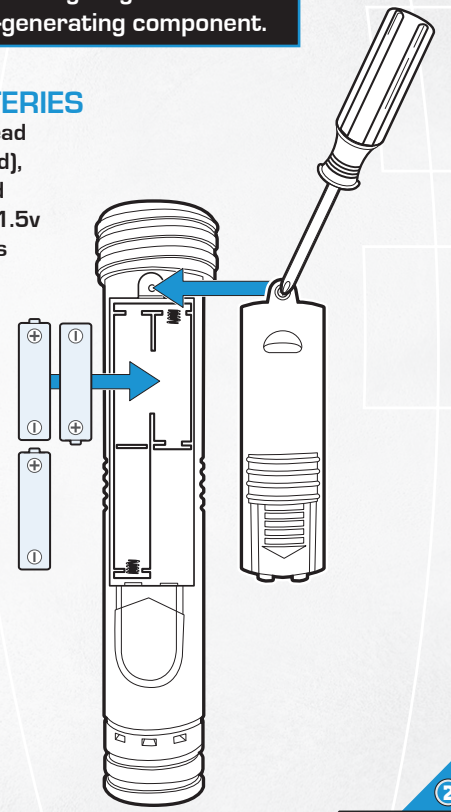



CAUTION: TO AVOID BATTERY LEAKAGE

1. Be sure to insert the batteries correctly and always follow the toy and battery manufacturers' instructions;
2. Do not mix old and new batteries or alkaline, standard (carbon-zinc) or rechargeable (nickel-cadmium) batteries;
3. Always remove weak or dead batteries from the product.

IMPORTANT: BATTERY INFORMATION

Please retain this information for future reference.

Batteries should be replaced by an adult.



CAUTION:

1. Always follow the instructions carefully. Use only batteries specified and be sure to insert them correctly by matching the + and - polarity markings.
2. Do not mix old batteries and new batteries, or standard (carbon-zinc) with alkaline batteries.
3. Remove exhausted or dead batteries from the product.
4. Remove batteries if product is not to be played with for a long time.
5. Do not short-circuit the supply terminals.
6. Should this product cause, or be affected by, local electrical interference, move it away from other electrical equipment. Reset (switching off and back on again or removing and re-inserting batteries) if necessary.
7. **RECHARGEABLE BATTERIES:** Do not mix these with any other types of battery. Always remove from the product before recharging. Recharge batteries under adult supervision. **DO NOT RECHARGE OTHER TYPES OF BATTERIES.**

3

STEP 2

Install one or more crystals
into the chamber in the hilt.

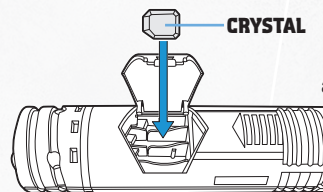

Each crystal causes the lightsaber to emit a different sound. After you complete your lightsaber, you can always switch, add or remove crystals.

Color Chart:

- Red: red crystal
- Blue: blue crystal
- Green: green crystal
- Aqua: blue and green crystals
- Orange: red and green crystals
- Purple: red and blue crystals

Note: If the crystals become misplaced or lost, turn the power on and off (see "Power Up" section below) to cycle through the different blade colors and sounds.

Store the extra crystals
in the storage chamber.

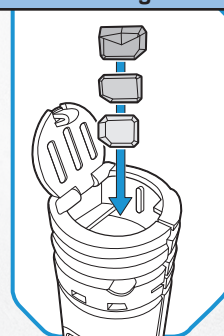

4

Place blade on hilt and hold it in place.

STEP 3

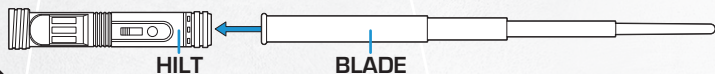

STEP 4

Choose a sleeve ring and slide it over the blade.

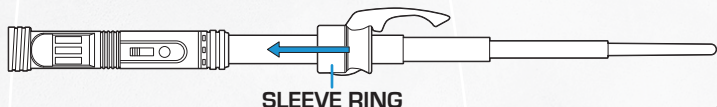

Choose a hilt sleeve and slide it on the hilt.

STEP 5



NOTE: Line up rib inside sleeve with slot on hilt.

NOTE: When customizing your lightsaber, always make sure the button is exposed so that you can “power up”!



STEP 6

Choose an end cap and attach it to the hilt.

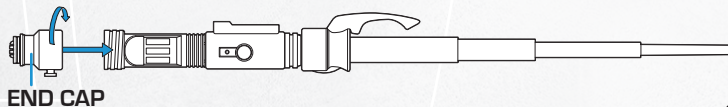

FINISHED

Congratulations! You have assembled your lightsaber!

CUSTOMIZE

The above steps are the basic steps for building a lightsaber. Switch and combine the parts to customize your lightsaber!

NOTE: Some configurations will cover the power button. Please be sure that the power button is exposed when completing your configuration.

POWER UP

Practice your dueling skills! Press the button to “power up” your lightsaber.

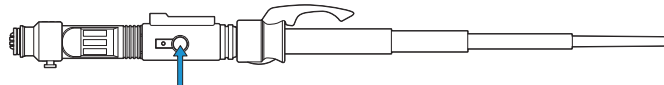

When customizing your lightsaber, always make sure the button is exposed so that you can “power up”!

5

6

ASSEMBLING CHARACTER-SPECIFIC LIGHTSABERS

Count Dooku Lightsaber



Yoda Lightsaber



Mace Windu Lightsaber

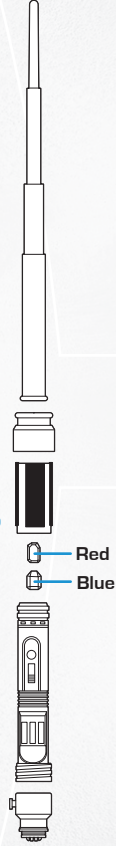

Maris Brood Lightsaber



7

8

