

BravettiTM

OWNER'S MANUAL

Model KP160H, KP160HV, KP160HC, KP160HS
120V, 60Hz., 10 Watts

Gel Canister Ice Cream Maker

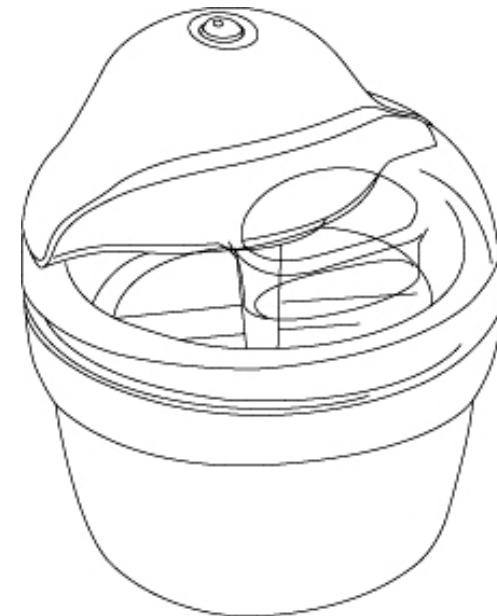

EURO-PRO Operating LLC
Boston, MA, 02465
1(800) 798-7398
www.euro-pro.com

IMPORTANT SAFETY INSTRUCTIONS

When using electrical appliances, basic safety precautions should always be followed, including the following:

1. Read all instructions before using.
2. To protect against fire, electric shock and personal injury, do not immerse appliance, its cord or plug, in water or other liquid.
3. Close supervision is necessary when any appliance is used near children.
4. Unplug from outlet when not in use, before putting on or taking off parts and before cleaning.
5. Avoid contact with moving parts.
6. Do not operate any appliance with a damaged cord or plug or after the appliance malfunctions or is dropped or damaged in any manner. Return appliance to EURO-PRO Corp. for examination, repair or electrical or mechanical adjustment.
7. The use of accessory attachments not recommended by the appliance manufacturer may result in fire, electrical shock or personal injury.
8. Do not use outdoors.
9. Do not let cord hang over edge of table or counter or touch hot surfaces.
10. To disconnect, turn unit Off and unplug from wall outlet.
11. Do not operate the unit dry. Always have ice cream mixture in the freezer canister when you plug in the unit.
12. The freezer canister should be washed and thoroughly towel-dried before use.
13. Keep hands, hair, clothing, spatulas and other utensils away during operation to reduce the risk of injury to persons and damage to the appliance. **DO NOT USE SHARP OBJECTS OR UTENSILS INSIDE THE FREEZER CANISTER!** Sharp objects will scratch and damage the inside of the freezer canister. A rubber spatula or wooden spoon may be used when the appliance is unplugged and in the "Off" position.
14. Be sure that the voltage indicated on the name plate matches with your home's voltage.
15. Never clean with scouring powders or hard implements.
16. Do not place or use the appliance on hot surface such as stove, hotplate or near open gas flame.
17. Do not expose the freezer canister to temperatures above 105° F (41° C).
18. Do not place any part of this Ice Cream Maker in dishwasher.

SAVE THESE INSTRUCTIONS

This appliance is for **HOUSEHOLD USE ONLY**. No user-serviceable parts inside. Power unit never needs lubrication. Do not attempt to service this product. Do not immerse the power unit in water or other liquid. A short power supply cord is provided to reduce the hazards resulting from entanglement or tripping over a longer cord. An extension cord may be used with care; however the marked electrical rating should be at least as great as the electrical rating of the appliance. The extension cord should not be allowed to drape over the counter or tabletop where it can be pulled on by children or tripped over.



POLARIZED PLUG

WARNING: To reduce the risk of electric shock, this appliance has a polarized plug (one blade is wider than the other). This plug will fit in a polarized outlet only one way. If the plug does not fit fully in the outlet, reverse the plug. If it still does not fit, contact a qualified electrician to install the proper outlet. Do not modify the plug in any way.

GETTING TO KNOW YOUR GEL CANISTER ICE CREAM MAKER

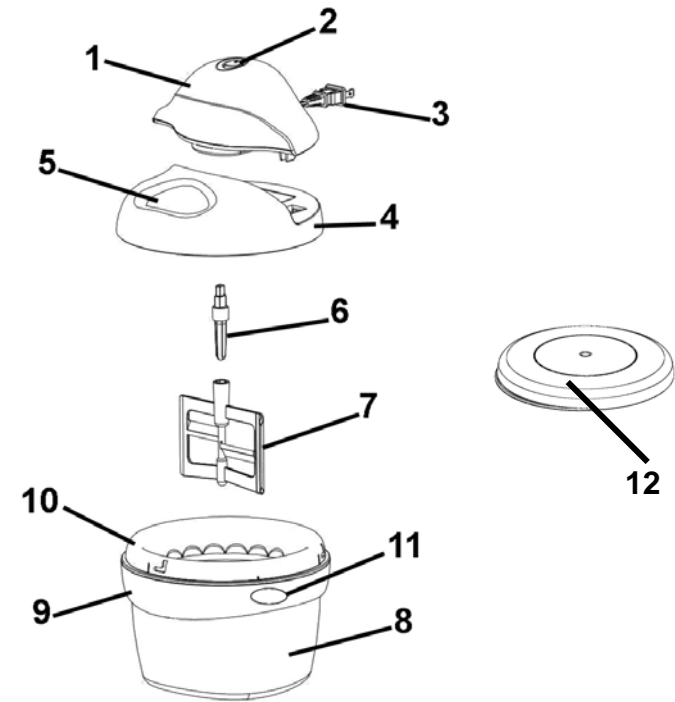

- | | |
|--------------------|---------------------|
| 1. Drive Unit | 7. Paddle |
| 2. On/Off Button | 8. Freezer Canister |
| 3. Electrical Plug | 9. Lower Ring |
| 4. Cover | 10. Upper Ring |
| 5. Feeder Hole | 11. Release Button |
| 6. Paddle Extender | 12. Storage Lid |

Technical Specifications

Voltage: 120V., 60Hz.
 Power: 10 Watts
 Capacity: 1.5 Quart

Features

- **Double insulated freezer canister.** Double insulated walls keep the freezer canister colder for longer periods and for better freezing results. The gel inside these double walls provides thorough and even freezing throughout use.
- **See through cover with feeder hole.** The see through cover allows you to keep an eye on the freezing process. The convenient feeder hole allows you to add ingredients without having to stop the unit to do so.

Before First Use

Remove all packing materials and manuals from inside your new gel canister ice cream maker. Wash each part of the unit which touches the ingredients, such as the Stirring Paddle, Lid, and the Ice Cream bucket. Parts should be washed with warm water and a mild dish washing detergent and wiped completely dry. Do **NOT** use abrasive cleaners to clean as these may damage your appliance. Power head may be wiped clean with a damp cloth. Do **NOT** clean appliance in dishwasher.

Freezing the Freezer Canister

The most important step in making frozen desserts, is making sure that the freezer canister is completely frozen. The Bravetti Gel Canister Ice Cream Maker features a double walled insulated freezer canister for perfect frozen desserts every time. To freeze your canister, wrap it in a large resealable freezer bag and place it upright in the coldest part of your freezer. Using a resealable freezer bag prevents ice crystals from forming on the freezer canister. The length of time to properly freeze the freezer canister depends on how cold your freezer temperature is. To make sure that your freezer canister is properly frozen, you should not hear any gel moving within the freezer canister when you shake it.

FREEZING GUIDE

FREEZER TEMP	APPROX. FREEZING TIME
-22° F / -30° C	8-9 Hours
-13° F / -25° C	12-13 Hours
0° F / -18° C	20-22 Hours
5° F / -15° C	24 Hours or more

Using Your Ice Cream Maker

Your ice cream maker can make up to 1 1/2 quarts of ice cream. Due to an increase in volume when freezing the ingredients, you should not exceed 1 quart of liquid ingredients. If you are using your own recipes, adapt the volume of the mixture not to exceed this amount.

1. Place the freezer canister into the coldest part of your freezer the day before. See chart for approximate freezing time.
2. Make sure that the On/Off button is in the "Off" position.
3. To assemble the unit, insert the drive unit into the cover until it locks in place. The two tabs on the bottom of the drive unit will lock into the cover. (Fig. 1)

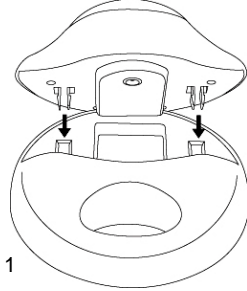

Fig. 1

3. Insert the paddle extender into the paddle (Fig.2) and then insert the paddle into the drive unit. (Fig. 3)

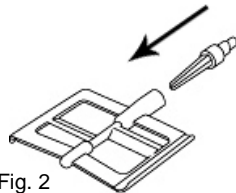

Fig. 2

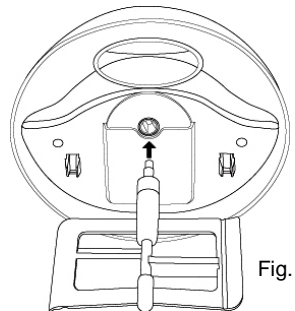

Fig. 3

Making Ice Cream (cont.)

4. Remove the freezer canister from the freezer.
5. Place drive unit with the cover on the freezer canister. Make sure that all the locking tabs are aligned. Rotate the cover clockwise slightly so that the tabs lock in place. (Fig. 4)

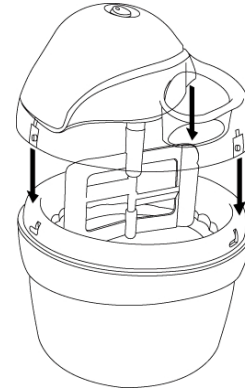

Fig. 4

6. Insert the plug into the power outlet and start the unit right away. This will prevent the paddle from freezing onto the freezer canister.
7. Pour the prepared ice cream mixture through the feeder hole into the freezer canister. (Fig. 5)

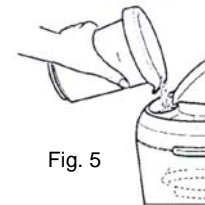

Fig. 5

Important: It is very important that the freezer canister be used immediately after being taken out of the freezer as it starts to thaw once it is removed from the freezer.

8. Leave the unit on for approximately 20-40 minutes or until the mixture reaches the desired consistency. Do not turn the unit "Off" during use as the mixture may freeze and prevent the paddle from turning.

9. To add ingredients after the freezing process has started, slowly add them through the feeder hole.
10. To avoid overheating the motor, the direction of the rotation will change when the mixture becomes too thick. If the direction of the rotation continues to change, the mixture is completely prepared. **Turn the unit off.**
11. Remove the cover with the paddle from the ice cream mixture. Use only rubber, plastic or wooden utensil to serve or remove from the freezer canister. Metal utensils may damage the freezer canister.
12. To further harden the ice cream, you may place the freezer canister in the freezer for a short period of time (no longer than thirty minutes). For longer freezing time. You should empty the ice cream in an airtight container.

Cleaning Your Ice Cream Maker

The freezer canister may be washed in warm water with a mild dishwashing detergent then dried thoroughly. To separate the freezer canister from the upper and lower rings for washing, press on the release button and lift the upper ring first. Then remove the lower ring by sliding it off the freezer canister. To replace the upper and lower rings after the freezer canister is completely dry, slide on the lower ring first aligning the hole for the release button with the arrow on the freezer canister. Then insert the upper ring making sure that the two rings snap together. Do **NOT** wash any part in a dishwasher. Do **NOT** use sharp utensils, scouring pads or abrasive cleansers to clean the freezer canister.

The drive unit may be cleaned with a damp cloth. Never immerse the drive unit in water or any other liquid. **Never** place the freezer canister in the freezer if it is still wet. Always make sure that the freezer canister is completely dry before placing in the freezer.

The storage lid may be washed with warm water and a mild dishwashing detergent then dried thoroughly.

Helpful Hints

- Some ice cream recipes require the mixture to be pre-cooked. You can make the recipe at least one day in advance. This will allow the mixture to cool down completely and also add volume. We recommend that you pre-chill the ice cream mixture for better results.
- Uncooked recipes will give you the best results when an electric mixer is used to cream the eggs and sugar. This helps increase the volume in the ice cream mixture.
- Most ice cream recipes are a combination of cream, milk, eggs and sugar. You may use any type of cream that you prefer, but the type of cream that you do use will affect the flavor and texture of the ice cream that you are making. The higher the percentage of fat in the cream, the richer the ice cream and the softer the texture. i.e. heavy cream has 35% fat, whipping cream has 30% fat, coffee or light cream has 18% fat and half & half has 10% fat. Any combination may be used but the total liquid measurement must remain the same.
- The ice cream mixture will stay fresh in the refrigerator for several days. Just make sure that it is well covered. Before adding to the freezer canister, stir it to make sure that the ingredients are well mixed together.
- When pouring into the freezer canister, stop at least 1" below the top of the canister as the mixture will increase in volume during the freezing process.
- If you wish to add alcohol to your ice cream recipe, add it when the mixture is semi hard or about 15 minutes into the process.
- If you are making a fruit sorbet, please note that the flavor of the sorbet will greatly depend on the ripeness of the fruit and/or type of juice that you use. If you find that the fruit is too tart, add sugar; if it is too ripe, decrease the amount of sugar. Also keep in mind that freezing lessens the sweetness of the recipe.
- You can use artificial sweeteners instead of sugar if you wish. Please note though that heat affects the sweetness of the artificial sweetener. We recommend that you use artificial sweeteners to mixtures that are cold or that have been completely cooled. When a recipe calls for you to heat the liquid ingredients so that the sugar may dissolve, omit the heating process and simply stir in the artificial sweetener until it is thoroughly dissolved.
- Always start with liquid ice cream mixtures when preparation starts. Do not use stiff mixtures such as whipped cream or frozen liquids.
- Do not operate the unit longer than required. If after 40 minutes the mixture is not yet solid or has thawed again, do not continue. Possible reasons for mixture not freezing: the freezer canister was not cold enough; the mixture was too warm; the proportion of the ingredients was not correct.
- Do not store prepared ice cream in the freezer canister for more than a few days.

Disposal of Unit

The gel in the freezer canister contains no toxic materials. You may dispose of as normal household waste.

Recipes

No Cook Coffee/Amaretto Ice Cream

2	Cups	Half-and-half
3	Tbs.	Instant Coffee
2	oz.	Amaretto liqueur
1 ½	Cups	Sugar
1	Tbsp.	Vanilla extract
4	Cups	Heavy Cream

1. In a small bowl combine the half and half, instant coffee, sugar, vanilla extract and Amaretto.
2. Stir to dissolve the sugar. Add the heavy cream.
3. Pour half of the mixture into the freezer canister and refrigerate the balance of the mixture for a second batch.
4. Freeze as directed.
5. Garnish with coffee beans.

Makes about 2 quarts

Strawberry Ice Cream

5	oz.	Sugar
5	oz.	Milk
3.5	oz.	Cream
7	oz.	Fresh Strawberries
1		Egg

1. Beat the egg together with the sugar.
2. Cut the strawberries into small pieces and add to the egg mixture.
3. Add the milk and the cream to the strawberry mixture.
4. Pour into the freezer canister and freeze as directed.



ONE (1) YEAR LIMITED WARRANTY

EURO-PRO OPERATING LLC warrants this product to be free from defects in material and workmanship for a period of one (1) year from the date of purchase when utilized for normal household use.

If your appliance fails to operate properly while in use under normal household conditions within the warranty period, return the complete appliance and accessories, freight prepaid. For Customer Service support, call 1(800) 798-7398 or visit our website www.euro-pro.com. If the appliance is found to be defective in material or workmanship, **EURO-PRO Operating LLC** will repair or replace it free of charge. Proof of purchase date and \$14.95 to cover the cost of return shipping and handling must be included.*

The liability of **EURO-PRO Operating LLC** is limited solely to the cost of the repair or replacement of the unit at our option. This warranty does not cover normal wear of parts and does not apply to any unit that has been tampered with or used for commercial purposes. This limited warranty does not cover damage caused by misuse, abuse, negligent handling or damage due to faulty packaging or mishandling in transit.

This warranty is extended to the original purchaser of the unit and excludes all other legal and/or conventional warranties. The responsibility of **EURO-PRO Operating LLC** if any, is limited to the specific obligations expressly assumed by it under the terms of the limited warranty. **In no event** is **EURO-PRO Operating LLC** liable for incidental or consequential damages of any nature whatsoever. Some states do not permit the exclusion or limitation of incidental or consequential damages, so the above may not apply to you.

This warranty gives you specific legal rights, and you may also have other rights which vary from state to state.

***Important: Carefully pack item to avoid damage in shipping. Be sure to include proof of purchase date and to attach tag to item before packing with your name, complete address and phone number with a note giving purchase information, model number and what you believe is the problem with item. We recommend you insure the package (as damage in shipping is not covered by your warranty). Mark the outside of your package "ATTENTION CUSTOMER SERVICE". We are constantly striving to improve our products, therefore the specifications contained herein are subject to change without notice.**



OWNERSHIP REGISTRATION CARD FOR CANADIAN CONSUMERS ONLY

Please fill out and mail the product registration card within ten (10) days of purchase. The registration will enable us to contact you in the unlikely event of a product safety notification. By returning this card you acknowledge to have read and understood the instructions for use, and warnings set forth in the accompanying instructions.

RETURN TO **EURO-PRO OPERATING LLC**, 4400 Bois Franc, St-Laurent, QC, H4S 1A7

KP160H: KP160HV : KP160HC: KP160HS

Appliance model

Date purchased

Name of store

Owner's name

Address

City

Prov

Postal Code

Printed in China