

LCD
15"



Let's make things better.



PHILIPS

Return your Warranty Registration card today to ensure you receive all the benefits you're entitled to.

Once your PHILIPS purchase is registered, you're eligible to receive all the privileges of owning a PHILIPS product. So complete and return the Warranty Registration Card enclosed with your purchase at once, and take advantage of these important benefits.

Warranty Verification

Registering your product within 10 days confirms your right to maximum protection under the terms and conditions of your PHILIPS warranty.

Owner Confirmation

Your completed Warranty Registration Card serves as verification of ownership in the event of product theft or loss.

Model Registration

Returning your Warranty Registration Card right away guarantees you'll receive all the information and special offers which you qualify for as the owner of your model.

PHILIPS

Congratulations on your purchase, and welcome to the "family!"

Dear PHILIPS product owner:

Thank you for your confidence in PHILIPS. You've selected one of the best-built, best-backed products available today. And we'll do everything in our power to keep you happy with your purchase for many years to come.

As a member of the PHILIPS "family," you're entitled to protection by one of the most comprehensive warranties and outstanding service networks in the industry.

What's more, your purchase guarantees you'll receive all the information and special offers for which you qualify, plus easy access to accessories from our convenient home shopping network.

And most importantly you can count on our uncompromising commitment to your total satisfaction.

All of this is our way of saying welcome-and thanks for investing in a PHILIPS product.

Sincerely,



Lawrence J. Blanford
President and Chief Executive Officer

P.S. Remember, to get the most from your PHILIPS product, you must return your Warranty Registration Card within 10 days. So please mail it to us right now!



Know these safety symbols



 This "bolt of lightning" indicates uninsulated material within your unit may cause an electrical shock. For the safety of everyone in your household, please do not remove product covering.

 The "exclamation point" calls attention to features for which you should read the enclosed literature closely to prevent operating and maintenance problems.

WARNING: TO PREVENT FIRE OR SHOCK HAZARD, DO NOT EXPOSE THIS EQUIPMENT TO RAIN OR MOISTURE.

CAUTION: To prevent electric shock, match wide blade of plug to wide slot, fully insert.

ATTENTION: Pour éviter les choc électriques, introduire la lame la plus large de la fiche dans la borne correspondante de la prise et pousser jusqu'au fond.

For Customer Use

Enter below the Serial No., which is located on the rear of the cabinet. Retain this information for future reference.

Model No. _____
Serial No. _____



Visit our World Wide Web Site at <http://www.philips.com>

IMPORTANT SAFETY INSTRUCTIONS

Read before operating equipment

1. Read these instructions.
2. Keep these instructions.
3. Heed all warnings.
4. Follow all instructions.
5. Do not use this apparatus near water.
6. Clean only with a dry cloth.
7. Do not block any of the ventilation openings. Install in accordance with the manufacturers instructions.
8. Do not install near any heat sources such as radiators, heat registers, stoves, or other apparatus (including amplifiers) that produce heat.
9. Do not defeat the safety purpose of the polarized or grounding-type plug. A polarized plug has two blades with one wider than the other. A grounding type plug has two blades and third grounding prong. The wide blade or third prong are provided for your safety. When the provided plug does not fit into your outlet, consult an electrician for replacement of the obsolete outlet.
10. Protect the power cord from being walked on or pinched particularly at plugs, convenience receptacles, and the point where they exit from the apparatus.
11. Only use attachments/accessories specified by the manufacturer.
12.  Use only with a cart, stand, tripod, bracket, or table specified by the manufacturer, or sold with the apparatus. When a cart is used, use caution when moving the cart/apparatus combination to avoid injury from tip-over.
13. Unplug this apparatus during lightning storms or when unused for long periods of time.
14. Refer all servicing to qualified service personnel. Servicing is required when the apparatus has been damaged in any way, such as power-supply cord or plug is damaged, liquid has been spilled or objects have fallen into apparatus, the apparatus has been exposed to rain or moisture, does not operate normally, or has been dropped.
15. This product may contain lead or mercury. Disposal of these materials may be regulated due to environmental considerations. For disposal or recycling information, please contact your local authorities or the Electronic Industries Alliance: www.eiae.org.
16. **Damage Requiring Service** - The appliance should be serviced by qualified service personnel when:
 - A. The power supply cord or the plug has been damaged; or
 - B. Objects have fallen, or liquid has been spilled into the appliance; or
 - C. The appliance has been exposed to rain; or
 - D. The appliance does not appear to operate normally or exhibits a marked change in performance; or
 - E. The appliance has been dropped, or the enclosure damaged.
17. **Tilt/Stability** - All televisions must comply with recommended international global safety standards for tilt and stability properties of its cabinets design.
 - Do not compromise these design standards by applying excessive pull force to the front, or top, of the cabinet which could ultimately overturn the product.
 - Also, do not endanger yourself, or children, by placing electronic equipment/toys on the top of the cabinet. Such items could unsuspectingly fall from the top of the set and cause product damage and/or personal injury.
18. **Wall or Ceiling Mounting** - The appliance should be mounted to a wall or ceiling only as recommended by the manufacturer.
19. **Power Lines** - An outdoor antenna should be located away from power lines.
20. **Outdoor Antenna Grounding** - If an outside antenna is connected to the receiver, be sure the antenna system is grounded so as to provide some protection against voltage surges and built up static charges. Section 810 of the National Electric Code, ANSI/NFPA No. 70-1984, provides information with respect to proper grounding of the masts and supporting structure grounding of the lead-in wire to an antenna-discharge unit, size of grounding connectors, location of antenna-discharge unit, connection to grounding electrodes and requirements for the grounding electrode. See Figure below.
21. **Objects and Liquid Entry** - Care should be taken so that objects do not fall and liquids are not spilled into the enclosure through openings.

EXAMPLE OF ANTENNA GROUNDING AS PER NATIONAL ELECTRICAL CODE (NEC)

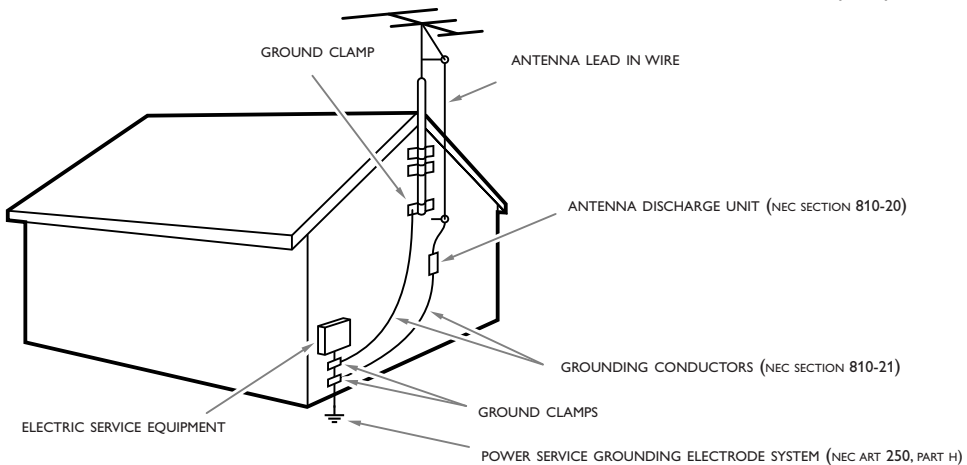

Note to the CATV system installer : This reminder is provided to call the CATV system installer's attention to Article 820-40 of the NEC that provides guidelines for proper grounding and, in particular, specifies that the cable ground shall be connected to the grounding system of the building, as close to the point of cable entry as practical.

Contents

Installation

- Preparation **4**
- Use of the remote control **5**
- To use the menus **6**
- Setup menu **6**
- Program/Erase channels **6**
 - Auto programming channels **6**
 - Memorizing/Erasing current channel **7**

Operation

- Buttons in front of the TV **7**
- Picture menu **8**
- Sound menu **8**
- Closed Caption **9**
- Parental control functions **10**
- Setting up blocking **10-11**

Connect peripheral equipment

- Connecting and selecting equipment **12-14**
- Connect your PC **15**
- Use of your PC **16**

- Tips **16**
- Before Calling Service **17**
- Glossary **18**
- Conversion tables for off-air and cable channels **19**

Help?

If this instruction manual does not give an answer or if 'Before Calling Service' does not solve your TV problem, you can call your Local Philips Customer or Service Centre. See the supplied World-wide guarantee booklet.

Please, have the Model and Product number which you can find at the back of your television set or on the packaging, ready, before calling the Philips helpline.

Model:

Product No:

Preparation

Please, make sure to connect the power plug to the wall outlet socket after connecting the TV to the adapter!

- 1 Place the TV on a solid surface.

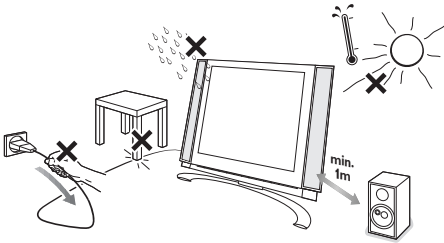

Ensure that the TV is placed in a position to allow free flow of air. Do not cover the ventilation openings on the back cover. To prevent any unsafe situations, no naked flame sources, such as lighted candles, should be placed on or in the vicinity. Avoid heat, direct sunlight and exposure to rain or water. The equipment shall not be exposed to dripping or splashing.

- 2 Insert the aerial plug firmly into the aerial socket **ANT IN** 75Ω at the back of the TV.

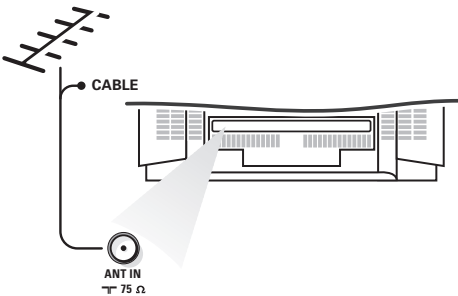

- 3 To connect your computer, see Connect peripheral equipment, Personal computer, p 15. To connect other peripherals, see p. 12.

- 4 Remote control: Remove the cover of the battery compartment. Insert the 2 batteries supplied (Type R6-LR6 1.5V).

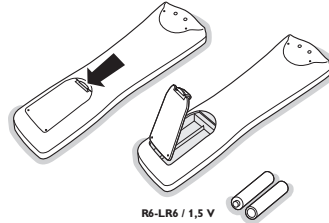

- 5 **Power:** This TV operates on a DC supply provided by the AC-DC adapter. The voltage is as indicated on the label on the back cover.

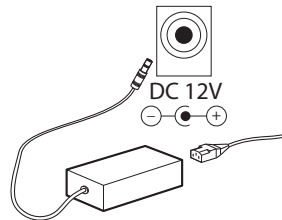

Only use the AC-DC adapter supplied with the TV and never apply an AC power cord to the TV directly. The AC-DC adapter operates on an AC power supply, the voltage is as indicated on the label of the AC-DC adapter.

Connect the DC plug of the AC-DC adapter to the DC 12V socket at the back of the TV. Connect the AC-DC adapter and its power cord.

Insert the power cord in the wall socket having a AC power supply of 110V.

- 6 **Turn the TV on:** Press the power button at the front side of the TV to turn it on or off.

If the TV is in standby mode, the standby indicator in front of the TV illuminates brightly. Press the  button on the remote control or the **- CH +** button or one of the digit buttons to turn the TV on.

See p. 7 to memorize the channels available in your local broadcast area.

Use of the remote control

Standby

Press to turn on/off the TV. The TV is never completely powered off unless it is physically unplugged.

EXT Source

Select your computer or other peripherals: press repeatedly to select **TV, VIDEO, S-VIDEO, COMPONENT** or **PC** monitor mode, according to where you connected your external source. See p. 12.

- **VIDEO** for a VCR connected to the AV connectors of the TV.
- **S-VIDEO** for a S-Video VCR connected to the **S-VIDEO** connector of the TV.
- **COMPONENT** for a DVD/DTV Set Top box or another component video device connected to **Y, Pb, Pr (480i)** and to the **AV AUDIO** inputs L and R.
- **PC** for a personal computer connected to the **PC INPUT** connector of the TV.

*Note: When a VCR is connected via the aerial socket, the TV is used in TV mode. Alternatively, you can select the tv, video, s-video, component or pc monitor mode with the **EXT** button on the remote control.*

0/9 Digit buttons

To select a TV channel.

P.P Previous program

To display the previously selected TV channel.

MENU Press repeatedly to display each menu.

OK Press this key to activate your choice, when in the menus.

SLEEP Sleep timer

With this key you can set a time period after which the TV should switch itself to standby. Press the key repeatedly to select the number of minutes. The counter runs from ..., 10, 20, 30... to 240 minutes. The timer begins to count down from the number of minutes selected after the display has disappeared.

*Note: To view the remaining time, press the **SLEEP** button once. To cancel the sleep time, repeatedly press the **SLEEP** button until ... appears.*

If you turn the TV off after setting the sleep time, the setting will be erased. Set it again.

CC Closed Caption

Press this button to turn Closed Caption on. Be sure you have selected **Caption On** in the Setup menu. See p. 9.

Volume

Press + or - to adjust the volume.

Mute

Temporarily interrupt the sound or restore it.

The captions automatically appear if the watched TV program provides **CC info** and **EZ-mute** has been selected as Closed Caption (see p. 9).

CH Channel selection

To browse through the TV channels which are not erased. To view a blocked channel, use the digit buttons to access the channel and enter your access code.

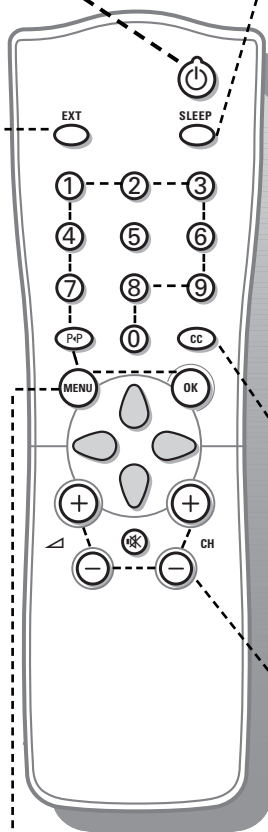

To use the menus

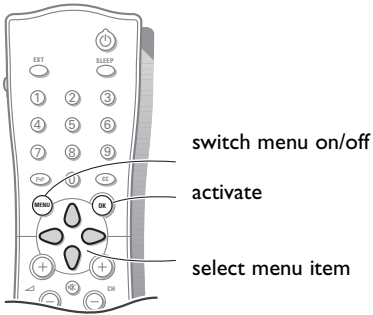

- 1 Press the **MENU** button repeatedly to display each menu.
- 2 Use the cursor up/down to select a menu item.
- 3 Use the cursor left/right to adjust the setting of a menu item or press the **OK** button to enter a submenu.
- 4 Press the **EXT** button to exit the menu.

Setup menu

Input	TV
Language	English
Captions	Off
Caption/Text	CC1
Parental ctl	

▲▼ ◀▶ MENU

- 1 Select **Input** and press the cursor right to select **TV** to be sure your remote control is in the TV mode.
- 2 Select your language.
- 3 Press the **MENU** button to select the channel menu to memorize the channels available in your local broadcast area.

Program/Erase channels

Auto programming channel

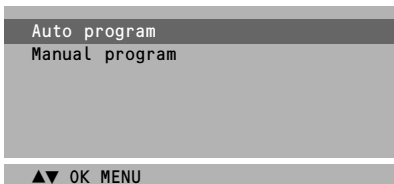

The Auto Program function memorizes all the receiving channels of terrestrial TV signals or cable TV programs

- 1 Press the **MENU** button to select the channel menu.
- 2 Press the **OK** button.
The Auto Program function memorizes the channels which are being received at that time.
*Note: If you press the **MENU** button in auto programming, the functions will stop and only channels programmed up to that time will remain.*
- 3 After auto programming is finished, check the memorized channels with the **CH +/-** button.

Memorizing/Erasing current channel



- 1 Select **Manual Program** in the channel menu.
- 2 Press the **OK** button to enter the Manual Program menu.
The current channel number is displayed.
- 3 Press the cursor left/right to select another channel number.
- 4 Select **Storage** with the cursor up/down.
- 5 Press the cursor left/right to select **Memory** or **Erase**.
The selected channel is memorized or erased.

Fine tune

In case of poor reception, you can improve the reception by fine tuning.

TV channels broadcast by a cable company

Some cable systems operate with frequency offsets that are as much as + 2 MHz or - 2 MHz. See Conversion tables, p. 19.

Off-air channels

The frequencies for TV channels used by a cable company may differ from the frequencies of off-air TV channels. Consult the tables on p. 18.

- 1 Select **Fine** in the Manual Program menu with the cursor up/down.
- 2 Press the cursor left/right to fine tune for the best picture and sound.
- 3 Press the **OK** button.
- 4 Press the **EXT** button to exit the menu.

Buttons in front of the TV

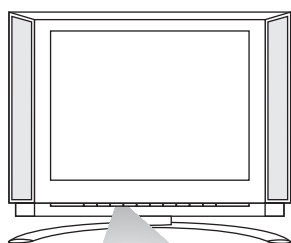

Should your remote control be lost or broken you can still operate your TV with the buttons in front of the TV.

ON/OFF: Press the power **ON/OFF** button to turn the TV on or off

TV/VIDEO: Press repeatedly to select **TV**, **VIDEO**, **S-VIDEO**, **COMPONENT** or **PC** monitor mode

MENU: Press repeatedly to display each menu

OK: Press this button to activate your choice when in the menu

-VOL + :

- Press - or + to select a menu item;
- Press - or + to adjust the volume;
- Press - or + to adjust the menu settings.

-CH/PR +:

- Press - or + to browse through the TV channels which are not erased;
- Press - or + to select a menu item;
- To turn the TV on from standby.

⏻: Turns the TV on from standby or off to standby.
The ⏻ indicator lights up brightly when the TV is in standby, dims when the TV is turned on.

Picture menu

Contrast	100
Brightness	60
Color	60
Tint	0
Sharpness	6

▲▼ ◀▶ OK MENU

- Contrast, Brightness, Color are adjusted from 0 to 100.
- Tint is adjusted from Red 50 to Green 50.
- Sharpness is adjusted from 0 to 10.

You can adjust picture contrast, brightness, color, tint and sharpness to the levels you prefer.

Press the **OK** button to store the adjustments. The message **Stored** appears.

Press the **EXT** button if you want to exit the menu

Sound menu

MTS	Mono/Stereo/SAP
Balance	0
AVL	On/Off
Equalizer	

▲▼ ◀▶ MENU

Cinema	
Music	
Sports	
User	
	0.1 0.5 1.5 5.0 10 kHz

▲▼ ◀▶ MENU

You can select your preferred sound setting or you can also adjust the sound frequency of the equalizer and the balance of the right and left speaker's sound output.

MTS

In case of second audio program (SAP) transmission, you can switch from **Mono** to **Stereo** or to the secondary language. In case of stereo transmission you can switch to **Mono** or **Stereo** sound.

AVL

Switch **AVL On** to maintain constant volume levels when switching TV channels.

Equalizer

- 1 Select **Equalizer** and press the **OK** button to enter the Equalizer menu.
- 2 Select one of the predefined factory sound settings or select **User** to adjust your personal sound settings of treble and bass.

Setting the equalizer User

- 1 Select **User** with the cursor up/down.
- 2 Press the cursor left/right to select a sound band.
- 3 Press the cursor up/down to adjust the appropriate sound level.
- 4 Press the **OK** button to store the Personal adjustments. The message **Stored** appears.

Press the **EXT** button if you want to exit the menu.

Closed Caption

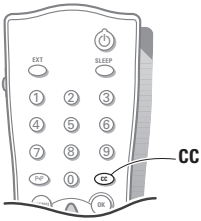

Input	TV
Language	English
Captions	Off
Caption/Text	CC1
Parental ctl	
▲▼▶ MENU	

Closed Captioning allows you to read the dialog of television programs on the TV screen. Designed to help the hearing impaired, this feature uses on screen "text boxes" to show dialogue and conversations while the TV program is in progress. Captions will appear on the screen only during captioned broadcasts.

Remark: the captions do not always use correct spelling and grammar.

Not all TV programs and product commercials are made for broadcast with Closed Caption information included. Refer to your area's TV program listings for the TV channels and times of Closed Caption shows. The captioned programs are usually noted in the TV listings with service marks such as "CC".

Turning Closed Caption On/Off

- 1 Select the desired TV program (Not a blocked channel or PC).
- 2 Press the **MENU** button once.
- 3 Select **Captions** with the cursor up/down.
- 4 Press the cursor left/right to select **Captions On**, **EZ mute** or **Off**.
EZ mute: Select this mode if you want the captions to appear automatically when the mute button  on the remote control is pressed, if the watched TV program provides **CC info**.

Caption modes:

- **Caption 1, 2, 3 or 4 mode:**
Dialogue (and descriptions) for the action on the captioned TV program shows on screen. Usually Caption 1 is the most used mode. Caption 2 may be used for alternate languages if they are being transmitted.
- **Text 1, 2, 3 or 4 mode:**
Often used for channel guide, schedules, bulletin board information for Closed Caption programs, news, weather information or stock market reports.
Not all Closed Caption modes are necessarily being used by a TV channel during the transmission of a Closed Caption program.

Setting Closed Caption

- 1 Press the cursor up/down to select **Caption/Text**.
- 2 Press the cursor left/right to select the desired Closed Caption mode.
- 3 Press the **EXT** button if you want to exit the menu.

Note: This television receiver provides display of television closed captioning in accordance with Section 15.119 of the FCC rules.

Caption tips:

Your TV might not receive caption signals normally when:

- Poor reception conditions are encountered.
- An old, bad or illegally recorded tape is played.
- Strong, random signals from a car or airplane interfere with the TV signals.
- The antenna signal is weak.
- The program wasn't captioned when it was produced, transmitted or taped.

Parental control function

Input	TV
Language	English
Captions	Off
Caption/Text	CC1
Parental ctl	
▲▼ OK MENU	

The Parental control function (V-chip) is used to block program viewing based on the ratings sent by the broadcaster. The default setting is to allow all programs to be viewed. Viewing can be blocked by the type of program and by the categories chosen to be blocked. It is also possible to block all program viewing for a time period.

To use the Parental Control Function, the following must be set:

1. Ratings and categories to be blocked.
2. Number of hours to lock the television viewing control.
3. Set a password.
4. Enable the lock

V-Chip rating and categories

Rating guidelines are provided by the broadcaster. Most television programs and television movies can be blocked by TV Rating and/or Individual Categories. Movies that have been shown at the theaters or direct-to-video movies use the Movie Rating System (MPAA) only.

Setting up Blocking

Input	TV
Language	English
Captions	Off
Caption/Text	CC1
Parental ctl	
▲▼ OK MENU	

Aux. Block	Sources blocked
MPAA	PG-13 and above
Age block	
Content blk	
Set hours	◀▶ 00 Hours
Set password	◀▶ To set
Lock On/Off	Off
▲▼ ◀▶ MENU	

- 1 Select **Parental ctl** and press the **OK** button to enter. If parental control is already set then enter the password when requested.
- 2 Select the types of blocking to be set: **MPAA, Age block, Content block, Set hours.**
- 3 Press the cursor up/down to select **Set password.**
- 4 Enter a four digit password. Enter it again when requested.
*Note: A new password may be chosen each time blocking is setup.
The Lock On/Off menu item is automatically set to Off when the password has been entered.*
- 5 Press the cursor left/right to set the **Lock On.**
Note: This is only possible when the hours for the blocking has been entered.
- 6 Press the **EXT** button on the remote control to exit the menu.

Did you forget your password !

First push the **MENU** button on the LCD TV set and while keeping pushed, press the **MENU** button on the remote control at the same time.

For Movies previously shown in theaters:

• **Movie Ratings:**

Unblocked	
G and above	(general audience)
PG and above	(parental guidance suggested)
PG-13 and above	(13 years and up)
R and above	(restricted)
NC-17 and above	(18 years and up)
X	(adult)

If you set PG-13 and above: G and PG movies will be available, PG-13, R, NC-17 and X will be blocked.

For Television programs including made-for-TV movies:

• **General TV Ratings:**

Unblocked	
TV-G and above	(general audience) (individual categories do not apply)
TV-PG and above	(parental guidance suggested)
TV-14 and above	(14 years and up)
TV-MA	(mature audience)

• **Children TV Ratings:**

Unblocked	
TV-Y and above	(youth) (individual content categories do not apply)
TV-Y7	(youth, 7 years and up)

• **Content Categories:**

Dialog - sexual dialogue	(applies to TV-PG and above, TV-14)
Language - adult language	(applies to TV-PG and above, TV-14 and above, TV-MA)
Sex scenes - sexual situations	(applies to TV-PG and above, TV-14 and above, TV-MA)
Violence	(applies to TV-PG and above, TV-14 and above, TV-MA)
FViolence - fantasy violence	(applies only to TV-Y7)
All Ratings	(blocks all viewing)

Connect Peripheral Equipment

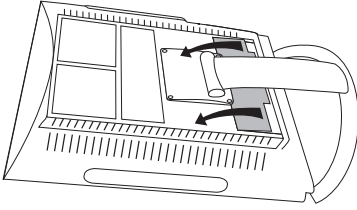

There is a wide range of video and audio equipment that can be connected to your TV. The following connection diagrams show you how to connect them.

Preparation

Remove the backplate at the back of the TV as shown on the illustration opposite. Lay the LCD TV with the screen down on a table as it will be easier to connect your peripheral equipment. Please take your precautions not to damage the screen.

Video recorder

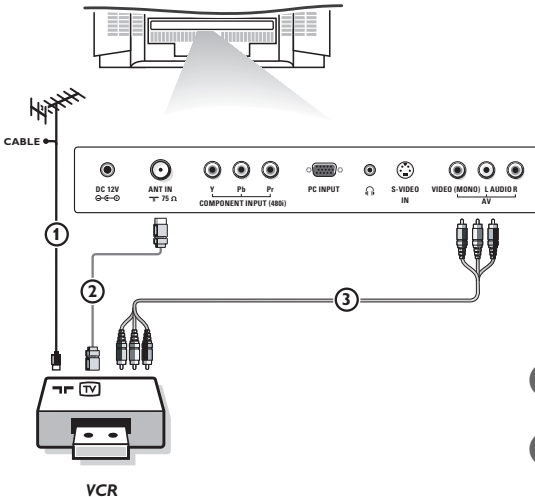

How to connect

- 1 Connect the supplied antenna cable ① to the **RF IN** port of your VCR.
- 2 Connect another RF cable ② from the output **OUT** of your VCR to the **ANT IN** input of your TV. Better quality when playing from your VCR can be obtained if you also connect the Video, Audio Left and Right (only for stereo equipment) cables ③ to the **VIDEO, AUDIO L and R** inputs **AV**.

If you are using only mono equipment, connect only the **VIDEO** and the **AUDIO L (Mono)** ports.

If your VCR has an S-VHS video jack:

For improved picture quality, connect a S-Video cable with the **S-VIDEO** input on the TV instead of connecting the VCR to the **VIDEO** port of **AV**. S-Video does not provide audio, so audio cables must still be connected to provide sound.

Watching VCR

- 1 If you use connection ②, select the TV channel 3 or 4.
- 2 If you use connection ③, select **VIDEO** or **S-VIDEO** in the Input menu item of the setup menu, see p. 6.
- 3 Insert a video tape in the VCR and press the **PLAY** button.

Camera, camcorder, Video Game set, ...

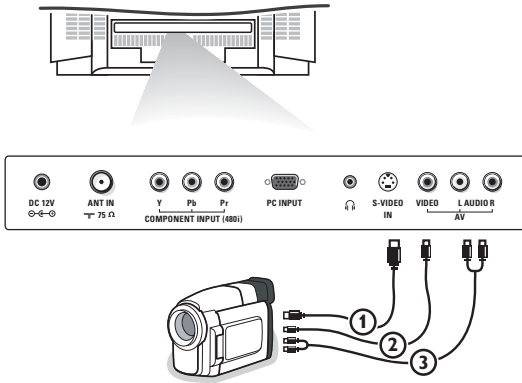

How to connect

- 1 Connect your camera, camcorder, videogame set, ... to the **VIDEO** port ② and **AUDIO L (MONO)** ③ for mono equipment.
- 2 For stereo equipment also connect **AUDIO R** ③.

S-VHS quality with an S-VHS camcorder is obtained by connecting the S-VHS cables with the **S-VIDEO** input ① and **AUDIO** input ③.

How to use

- 1 Select **VIDEO** or **S-VIDEO** in the Input menu item of the setup menu, see p. 6.
- 2 Turn on the external AV equipment.

DVD player

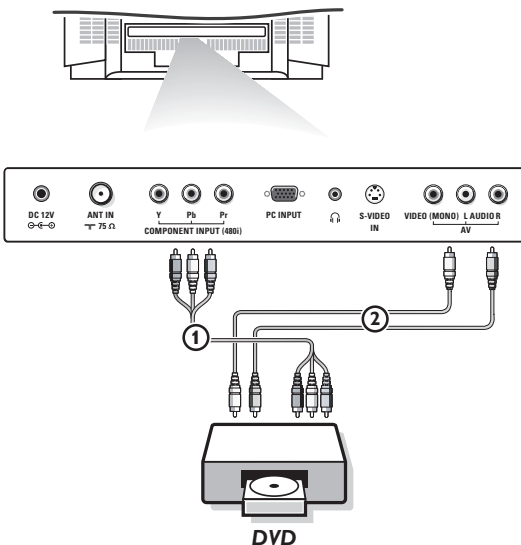

How to connect

- 1 Connect the three separate component video cables ① to the DVD player's **Y, Pb** and **Pr** ports and to the **Y, Pb** and **Pr (480i)** ports on the TV.
- 2 Connect the audio cables ② to the DVD player's **AUDIO L** and **R** ports and to the **L (MONO)** and **R AUDIO** AV ports on the TV.

How to use

- 1 Select **COMPONENT** in the Input menu item of the setup menu, see p. 6.
- 2 Turn on the DVD set.

Digital Set Top Box

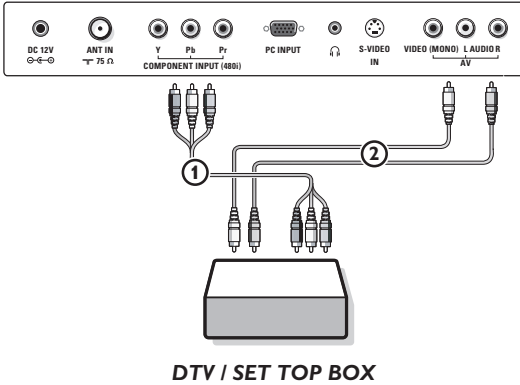

When you dispose of a Digital Antenna cable connected to a digital Set Top Box, connect the Set Top Box to the **COMPONENT INPUT (480i)**.

How to connect

- 1 Connect the three separate component video cables ① to the DTV player's **Y, Pb** and **Pr** ports and to the **Y, Pb** and **Pr (480i)** ports on the TV.
- 2 Connect the audio cables ② to the DTV player's **AUDIO L** and **R** ports and to the **L (MONO)** and **RAUDIO AV** ports on the TV.



How to use

- 1 Select **COMPONENT** in the Input menu item of the setup menu, see p. 6.
- 2 Turn on the DTV Set Top Box set.

Warning: In case you notice scrolling images, wrong colors or no color, no picture or even combinations of these, on your screen, check if the connections are done in the right way. Check if the cable colors match with the input connector colors.

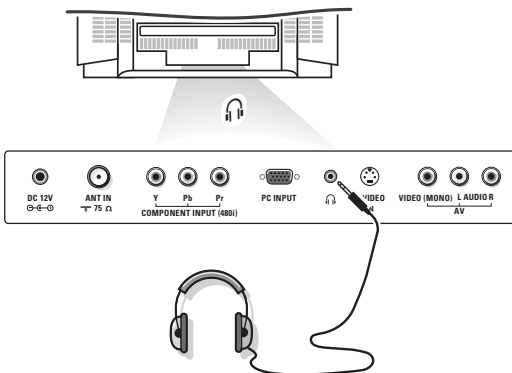
Headphone



- 1 Insert the plug into the headphone port .
- 2 Press the  button on the remote control to switch off the sound from the headphone and the internal loudspeakers of the TV.
- 3 Press the cursor left/right to adjust the volume.

Note: When a TV channel or external AV source is blocked because of a rating set via the Parental control menu (see p. 10), also the headphone is muted.

Personal computer

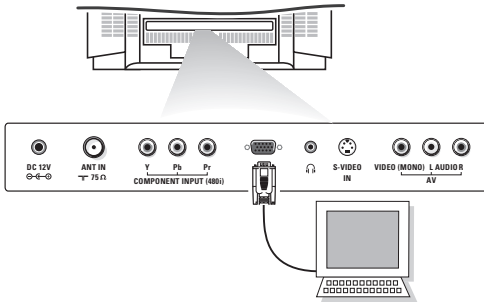

- 1 Connect one end of a (male to male) VGA cable to the video card of the computer and the other end to the VGA connector **PC INPUT** at the back of the TV. Fix the connectors firmly with the screws on the plug.
Note: the VGA cable is not supplied with the TV.
- 2 In case of a Multimedia computer, connect the audio cables to the audio outputs of your Multimedia computer and to the **AUDIO L** and **R** connectors of the **AV** input of the TV.
- 3 Press the **EXT** button on the remote control or select **Input** in the setup menu (See p. 6) to select PC.
- 4 Switch on the computer. The TV can be operated as the computer monitor.

Note: If you have an Apple Macintosh computer, connect the VGA desktop block from the 3 row 15 pin to 2 row 15 pin with the signal cable and connect the VGA desktop block to the Apple Macintosh computer.

Monitor Display modes

MODE	Resolution	Horizontal Frequency (KHz)	Vertical Frequency (Hz)
VGA	640x480	31,5 KHz	60Hz
	640x480	35,0 KHz	67Hz
	640x480	37,9 KHz	72Hz
	640x480	37,5 KHz	75Hz
	640x480	43,3 KHz	85Hz
(DOS) 720x400	31,5 KHz	70Hz	
SVGA	800x600	35,2 KHz	56Hz
	800x600	37,9 KHz	60Hz
	800x600	48,1 KHz	72Hz
	800x600	46,9 KHz	75Hz
	800x600	53,7 KHz	85Hz
(MAC) 832x624	49,7KHz	75Hz	
XGA	1024x768	48,4KHz	60Hz
	1024x768	56,5KHz	70Hz
	1024x768	60,0KHz	75Hz
	1024x768	68,7KHz	85Hz

Note:

- If the set is cold, there may be a small "flicker" when the set is switched on. This is normal, there is nothing wrong with the set.
- If possible, use the VESA 1,024x768@60Hz video mode to obtain the best image quality for your LCD monitor. If used under the other resolutions, some scaled or processed pictures may appear on the screen. The TV has been pre-adjusted to the mode VESA 1,024x768@60Hz.
- Some dot defects may appear on the screen, like red, green or blue spots. However, this will have no impact or effect on the monitor performance.
- Do not press the LCD screen with your finger for a long time as this may incur some afterimages.

Use of the PC menu

Input	PC
Input	60
Brightness	90
Contrast	0
Horizontal position	0
Vertical position	40
Clock	16
Clock phase	
Auto configure	
Reset	

▲▼ ◀▶ MENU

You can adjust picture contrast, brightness, horizontal and vertical position, clock, clock phase, auto-configure and factory settings as you prefer.

- 1 Repeatedly press the **EXT** button on the remote control or select **Input** in the setup menu, see p. 6 to select the PC monitor mode.
- 2 Press the **MENU** button to select the PC menu.
- 3 Use the cursor up/down to select the desired PC item.
- 4 Use the cursor left/right to make appropriate adjustments.

Horizontal and vertical picture position

Press the cursor left/right to adjust the picture position.

Clock

Press the cursor left/right to minimize any vertical bars or stripes visible on the screen background.

Clock phase

Press the cursor left/right to, when necessary, adjust the pixel phase of the picture to avoid picture interference.

Auto-configure

Select **Auto-configure On** for the automatic adjustment of the screen position, clock and clock phase.

Press the **OK** button.

When Auto-configure is in progress, the displayed picture will disappear for a few seconds.

Note: Some signals from some graphic boards may not function properly. If the results are unsatisfactory, adjust your monitor's position, clock and clock phase manually.

Reset

Select **Reset On** to return to the factory predefined settings.

Press the **OK** button.

- 5 Press the **EXT** button to exit the menu.

Tips

Care of the screen

Do not rub or strike the screen with anything hard as this may scratch, mar, or damage the screen permanently. Unplug the screen before cleaning the screen. Dust the TV by wiping the screen and the cabinet with a soft, clean cloth. If the screen requires additional cleaning, use a clean, damp cloth. Do not use liquid cleaners or aerosol cleaners.

Mobile telephone warning

To avoid disturbances in picture and sound, malfunctioning of your TV or even damage to the TV, keep away your mobile telephone from the TV.

End of life directives

We are paying a lot of attention to produce environmentally-friendly in green focal areas. Your new receiver contains materials which can be recycled and reused. At the end of its life specialized companies can dismantle the discarded receiver to concentrate the reusable materials and to minimize the amount of materials to be disposed of.

Please ensure you dispose of your old receiver according to local regulations.

How to dispose of batteries?

The batteries supplied do not contain the heavy metals mercury and cadmium. Nevertheless in many countries batteries may not be disposed of with your household waste. Please ensure you dispose of batteries according to local regulations.

Before Calling Service

Please make these simple checks before calling service. These tips may save you time and money since charges for receiver installation and adjustments of customer controls are not covered under your warranty.

Symptoms	Items to Check and Actions to follow
“Ghost” or double images	<ul style="list-style-type: none"> This may be caused by obstruction to the antenna due to high rise buildings or hills. Using a highly directional antenna may improve the picture.
No power	<ul style="list-style-type: none"> Check that the TV’s AC power cord is plugged into the mains socket. Unplug the TV, wait for 60 seconds. Then re-insert plug into the mains socket and turn on the TV again.
No picture	<ul style="list-style-type: none"> Check antenna connections at the rear of the TV to see if it is properly connected to the TV. Possible broadcast station trouble. Try another channel. Adjust the contrast and brightness settings. Check the Closed Captions control. Some TEXT modes could block the screen. Switch your VGA-source to a correct display mode.
Good picture but no sound	<ul style="list-style-type: none"> Increase the VOLUME. Check that the TV is not muted, press the  button on the remote control.
Good sound but poor color	<ul style="list-style-type: none"> Adjust the contrast, color and brightness settings.
Poor picture	<ul style="list-style-type: none"> Sometimes, poor picture quality occurs when having activated an S-VHS camera or camcorder connected and having connected another peripheral at the same time. In this case, switch off one of the other peripherals.
Snowy picture and noise	<ul style="list-style-type: none"> Check the antenna connection.
Horizontal dotted line	<ul style="list-style-type: none"> This may be caused by electrical interference (e.g. hairdryer, nearby neon lights, etc.) Turn off the equipment.
Television not responding to remote control	<ul style="list-style-type: none"> Check whether the batteries are working. Replace if necessary. Clean the remote control sensor lens on the TV. You can still use the buttons at the front of your TV. Select the TV mode to be sure your remote control is in the TV mode.
No stable or not synchronized VGA picture	<ul style="list-style-type: none"> Check if you have selected the correct VGA mode in your PC. See p. 15.

If your problem is not solved

Turn your TV off and then on again once.

Never attempt to repair a defective TV yourself.

Check with your dealer or call a TV technician.

**Tel. number Philips Customer Care Center
800-531-0039**

Glossary

Audio/Video Inputs

Located on the rear and the front of the receiver these connectors (RCA phono type plug) are used for the input of audio and video signals. Designed for use with VCRs (or other accessories) in order to receive higher picture resolution and offer sound connection options.

Menu

An on-screen listing of feature controls shown on the TV screen that are made available for user adjustments.

MPAA

Motion Picture Association of America

Multichannel Television sound (MTS)

The broadcast standard that allows for stereo sound to be transmitted with the TV picture.

Programming

The procedure of adding or deleting channel numbers into the TV's memory.

In this way the TV 'remembers' only the locally available or desired channel numbers and skips over any unwanted channel numbers.

Regulatory Notices - Federal Communications Commission Notice

This equipment has been tested and found to comply with the limits for a Class B digital device, pursuant to part 15 of the FCC Rules. These limits are designed to provide reasonable protection against harmful interference in a residential installation. This equipment generates, uses, and can radiate radio frequency energy and, if not installed and used in accordance with the instructions, may cause harmful interference to radio communications. However, there is no guarantee that interference will not occur in a particular installation. If this equipment does cause harmful interference to radio or television reception, which can be determined by turning the equipment off and on, the user is encouraged to try to correct the interference by one or more of the following measures:

Reorient or relocate the receiving antenna.

Increase the separation between the equipment and the TV.

Connect the equipment into an outlet on a circuit different from that to which the receiver is connected.

Consult the dealer or an experienced radio or television technician for help.

RF

Radio Frequency or modulated signal design used as the carrier for television broadcasts.

Second Audio Program (SAP)

Another or additional audio channel provided for in the Multichannel Television Sound (MTS) broadcast standard. A monaural soundtrack included within the recorded or video signal (usually containing a second language translation for the displayed program).

Sleep Timer

Function with which you can set a time period after which the TV should turn itself off.

S-Video Input

Allows direct connection of high-resolution video sources, such as a Super VHS videocassette recorder, Laser Disc player, etc. Provides improved picture resolution, sharpness, and clarity.

Modifications -

The FCC requires the user to be notified that any changes or modifications made to this device that are not expressly approved by Philips Consumer Electronics may void the user's authority to operate the equipment.

Cables -

Connections to this device must be made with shielded cables with metallic RFI/EMI connector hoods to maintain compliance with FCC Rules and Regulations.

Canadian notice -

This Class B digital apparatus meets all requirements of the Canadian Interference-Causing Equipment Regulations.

Avis Canadien -

Cet appareil numérique de la classe B respecte toutes les exigences du Règlement sur le matériel brouilleur du Canada.

Conversion Table A: channel to frequency (in MHz) for off-air channels.

The frequencies used by a cable company may differ from the frequencies on the table. Consult your cable company or your dealer for detailed information.

Channel	MHz	Channel	MHz	Channel	MHz	Channel	MHz
2	55.25	14	471.25	39	621.25	64	771.25
3	61.25	15	477.25	40	627.25	65	777.25
4	67.25	16	483.25	41	633.25	66	783.25
5	77.25	17	489.25	42	639.25	67	789.25
6	83.25	18	495.25	43	645.25	68	795.25
7	175.25	19	501.25	44	651.25	69	801.25
8	181.25	20	507.25	45	657.25		
9	187.25	21	513.25	46	663.25		
10	193.25	22	519.25	47	669.25		
11	199.25	23	525.25	48	675.25		
12	205.25	24	531.25	49	681.25		
13	211.25	25	537.25	50	687.25		
		26	543.25	51	693.25		
		27	549.25	52	699.25		
		28	555.25	53	705.25		
		29	561.25	54	711.25		
		30	567.25	55	717.25		
		31	573.25	56	723.25		
		32	579.25	57	729.25		
		33	585.25	58	735.25		
		34	591.25	59	741.25		
		35	597.25	60	747.25		
		36	603.25	61	753.25		
		37	609.25	62	759.25		
		38	615.25	63	765.25		

Conversion Table B: Channel to frequency (in MHz) for cable TV channels.

The frequencies used by a cable company may differ from the frequencies on the table. Consult your cable company or your dealer for detailed information.

Channel	MHz	Channel	MHz	Channel	MHz	Channel	MHz
C1	73.25						
C2	55.25	C33	277.25	C64	463.25	C95	91.25
C3	61.25	C34	283.25	C65	469.25	C96	97.25
C4	67.25	C35	289.25	C66	475.25	C97	103.25
C5	77.25	C36	295.25	C67	481.25	C98	109.25
C6	83.25	C37	301.25	C68	487.25	C99	115.25
C7	175.25	C38	307.25	C69	493.25	C100	649.25
C8	181.25	C39	313.25	C70	499.25	C101	655.25
C9	187.25	C40	319.25	C71	505.25	C102	661.25
C10	193.25	C41	325.25	C72	511.25	C103	667.25
C11	199.25	C42	331.25	C73	517.25	C104	673.25
C12	205.25	C43	337.25	C74	523.25	C105	679.25
C13	211.25	C44	343.25	C75	529.25	C106	685.25
C14	121.25	C45	349.25	C76	535.25	C107	691.25
C15	127.25	C46	355.25	C77	541.25	C108	697.25
C16	133.25	C47	361.25	C78	547.25	C109	703.25
C17	139.25	C48	367.25	C79	553.25	C110	709.25
C18	145.25	C49	373.25	C80	559.25	C111	715.25
C19	151.25	C50	379.25	C81	565.25	C112	721.25
C20	157.25	C51	385.25	C82	571.25	C113	727.25
C21	163.25	C52	391.25	C83	577.25	C114	733.25
C22	169.25	C53	397.25	C84	583.25	C115	739.25
C23	217.25	C54	403.25	C85	589.25	C116	745.25
C24	223.25	C55	409.25	C86	595.25	C117	751.25
C25	229.25	C56	415.25	C87	601.25	C118	757.25
C26	235.25	C57	421.25	C88	607.25	C119	763.25
C27	241.25	C58	427.25	C89	613.25	C120	769.25
C28	247.25	C59	433.25	C90	619.25	C121	775.25
C29	253.25	C60	439.25	C91	625.25	C122	781.25
C30	259.25	C61	445.25	C92	631.25	C123	787.25
C31	265.25	C62	451.25	C93	637.25	C124	793.25
C32	271.25	C63	457.25	C94	643.25	C125	799.25



Printed on recycled paper

