



EN User Manual

FR Manuel de l'utilisateur

ES Guía del usuario

EN: For further assistance, call the customer support service in your country.

- U.S.A., PUERTO RICO, OR U.S. VIRGIN ISLANDS:
1-888-PHILIPS (1-888-744-5477)
- CANADA: 1-800-661-6162 (French speaking),
1-888-PHILIPS (1-888-744-5477) - (English or Spanish)

Enter below the Serial No. located on the rear of the cabinet.

FR: Pour obtenir de l'aide supplémentaire, communiquez avec le centre de service à la clientèle de votre pays.

- POUR OBTENIR DE L'AIDE AUX ÉTATS-UNIS, À PUERTO RICO OU AUX ÎLES VIERGES AMÉRICAINES:
1-888-PHILIPS (1-888-744-5477)
- CANADA : 1-800-661-6162 (pour français),
1-888-PHILIPS (1-888-744-5477) - (pour anglais ou en espagnol)

Entrez ci-dessous le numéro de série qui se trouve à l'arrière du boîtier du dispositif.

ES: Para obtener más información, llame al servicio de soporte al cliente de su país.

- LOS ESTADOS UNIDOS, PUERTO RICO O EN LAS ISLAS VÍRGENES DE LOS ESTADOS UNIDOS:
1-888-PHILIPS (1-888-744-5477)
- CANADÁ: 1-800-661-6162 (en francés),
1-888-PHILIPS (1-888-744-5477) - (en inglés o español)

Escriba a continuación el N° de serie, el cual se encuentra en la parte posterior del gabinete.

Model / Modèle / Modelo :

Serial / Série / Serie:

PHILIPS

Return your Product Registration Card or register online at www.philips.com/welcome today to get the very most from your purchase.

Registering your model with PHILIPS makes you eligible for all of the valuable benefits listed below, so don't miss out. Complete and return your Product Registration Card at once, **or register online at www.philips.com/welcome** to ensure:

*Proof of Purchase

Returning the enclosed card guarantees that your date of purchase will be on file, so no additional paperwork will be required from you to obtain warranty service.

*Product Safety Notification

By registering your product, you'll receive notification - directly from the manufacturer - in the rare case of a product recall or safety defect.

*Additional Benefits

Registering your product guarantees that you'll receive all of the privileges to which you're entitled, including special money-saving offers.

PHILIPS

Congratulations on your purchase, and welcome to the "family!"

Dear PHILIPS product owner:

Thank you for your confidence in PHILIPS. You've selected one of the best-built, best-backed products available today. We'll do everything in our power to keep you happy with your purchase for many years to come.

As a member of the PHILIPS "family," you're entitled to protection by one of the most comprehensive warranties and outstanding service networks in the industry. What's more, your purchase guarantees you'll receive all the information and special offers for which you qualify, plus easy access to accessories from our convenient home shopping network.

Most importantly, you can count on our uncompromising commitment to your total satisfaction.

All of this is our way of saying welcome - and thanks for investing in a PHILIPS product.

P.S. To get the most from your PHILIPS purchase, be sure to complete and return your Product Registration Card at once, or register online at:

www.philips.com/welcome

Know these
safety symbols



This "bolt of lightning" indicates un-insulated material within your unit may cause an electrical shock. For the safety of everyone in your household, please do not remove product covering.

The "exclamation point" calls attention to features for which you should read the enclosed literature closely to prevent operating and maintenance problems.

WARNING: To reduce the risk of fire or electric shock, this apparatus should not be exposed to rain or moisture and objects filled with liquids, such as vases, should not be placed on this apparatus.

CAUTION: To prevent electric shock, match wide blade of plug to wide slot, fully insert.

ATTENTION: Pour éviter les choc électriques, introduire la lame la plus large de la fiche dans la borne correspondante de la prise et pousser jusqu'au fond.

For Customer Use

Enter below the Serial No. which is located on the rear of the cabinet. Retain this information for future reference.

Model No. _____

Serial No. _____

IMPORTANT SAFETY INSTRUCTIONS

Read before operating equipment

1. Read these instructions.
2. Keep these instructions.
3. Heed all warnings.
4. Follow all instructions.
5. Do not use this apparatus near water.
6. Clean only with a dry cloth.
7. Do not block any of the ventilation openings. Install in accordance with the manufacturers instructions.
8. Do not install near any heat sources such as radiators, heat registers, stoves, or other apparatus (including amplifiers) that produce heat.
9. Do not defeat the safety purpose of the polarized or grounding-type plug. A polarized plug has two blades with one wider than the other. A grounding type plug has two blades and third grounding prong. The wide blade or third prong are provided for your safety. When the provided plug does not fit into your outlet, consult an electrician for replacement of the obsolete outlet.
10. Protect the power cord from being walked on or pinched particularly at plugs, convenience receptacles, and the point where they exit from the apparatus.
11. Only use attachments/accessories specified by the manufacturer.
12.  Use only with a cart, stand, tripod, bracket, or table specified by the manufacturer, or sold with the apparatus. When a cart is used, use caution when moving the cart/apparatus combination to avoid injury from tip-over.
13. Unplug this apparatus during lightning storms or when unused for long periods of time.
14. Refer all servicing to qualified service personnel. Servicing is required when the apparatus has been damaged in any way, such as power-supply cord or plug is damaged, liquid has been spilled or objects have fallen into apparatus, the apparatus has been exposed to rain or moisture, does not operate normally, or has been dropped.
15. This product may contain lead or mercury. Disposal of these materials may be regulated due to environmental considerations. For disposal or recycling information, please contact your local authorities or the Electronic Industries Alliance: www.eiae.org.
16. **Damage Requiring Service** - The appliance should be serviced by qualified service personnel when:
 - A. The power supply cord or the plug has been damaged; or
 - B. Objects have fallen, or liquid has been spilled into the appliance; or
 - C. The appliance has been exposed to rain; or
 - D. The appliance does not appear to operate normally or exhibits a marked change in performance; or
 - E. The appliance has been dropped, or the enclosure damaged.
17. **Tilt/Stability** - All televisions must comply with recommended international global safety standards for tilt and stability properties of its cabinets design.
 - Do not compromise these design standards by applying excessive pull force to the front, or top, of the cabinet which could ultimately overturn the product.
 - Also, do not endanger yourself, or children, by placing electronic equipment/toys on the top of the cabinet. Such items could unsuspectingly fall from the top of the set and cause product damage and/or personal injury.
18. **Wall or Ceiling Mounting** - The appliance should be mounted to a wall or ceiling only as recommended by the manufacturer.
19. **Power Lines** - An outdoor antenna should be located away from power lines.
20. **Outdoor Antenna Grounding** - If an outside antenna is connected to the receiver, be sure the antenna system is grounded so as to provide some protection against voltage surges and built up static charges. Section 810 of the National Electric Code, ANSI/NFPA No. 70-1984, provides information with respect to proper grounding of the mats and supporting structure grounding of the lead-in wire to an antenna-discharge unit, size of grounding connectors, location of antenna-discharge unit, connection to grounding electrodes and requirements for the grounding electrode. See Figure below.
21. **Objects and Liquid Entry** - Care should be taken so that objects do not fall and liquids are not spilled into the enclosure through openings.
 - a) **Warning:** To reduce the risk of fire or electric shock, this apparatus should not be exposed to rain or moisture and objects filled with liquids, such as vases should not be placed on this apparatus.
22. **Battery Usage CAUTION** - To prevent battery leakage that may result in bodily injury, property damage, or damage to the unit:
 - Install all batteries correctly, with + and - alignment as marked on the unit.
 - Do not mix batteries (old and new or carbon and alkaline, etc.)
 - Remove batteries when the unit is not used for a long time.

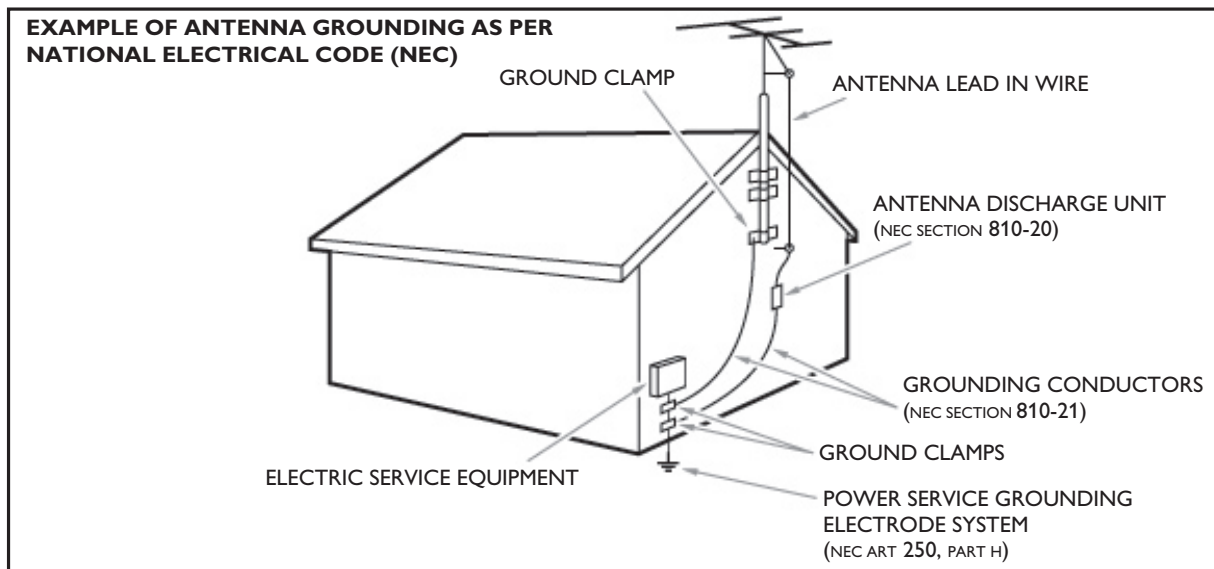

Note to the CATV system installer: this reminder is provided to call the CATV system installer's attention to Article 820-40 of the NEC that provides guidelines for proper grounding and, in particular, specifies that the cable ground shall be connected to the grounding system of the building, as close to the point of cable entry as practical.

2007 © Koninklijke Philips Electronics N.V. All rights reserved. Specifications are subject to change without notice. Trademarks are the property of Koninklijke Philips Electronics N.V. or their respective owners.

Philips reserves the right to change products at any time without being obliged to adjust earlier supplies accordingly.

The material in this manual is believed adequate for the intended use of the system. If the product, or its individual modules or procedures, are used for purposes other than those specified herein, confirmation of their validity and suitability must be obtained. Philips warrants that the material itself does not infringe any United States patents. No further warranty is expressed or implied.

Philips can't be held responsible neither for any errors in the content of this document nor for any problems as a result of the content in this document. Errors reported to Philips will be adapted and published on the Philips support website as soon as possible.

Warranty

No components are user-serviceable. Do not open or remove covers to the inside of the product. Repairs may only be done by Philips Service Centers and official repair shops. Failure to do so shall void any warranty, stated or implied. Any operation expressly prohibited in this manual, any adjustments, or assembly procedures not recommended or authorised in this manual shall void the warranty.

Pixel characteristics

This LCD product has a high number of color pixels. Although it has effective pixels of 99,999% or more, black dots or bright points of light (red, green or blue) may appear constantly on the screen. This is a structural property of the display (within common industry standards) and is not a malfunction.

Open source software

This television contains open source software. Philips hereby offers to deliver or make available, upon request, for a charge no more than the cost of physically performing source distribution, a complete machine-readable copy of the corresponding source code on a medium customarily used for software interchange.

This offer is valid for a period of 3 years after the date of purchase of this product. To obtain the source code, write to

Philips Consumer Lifestyle
Development Manager
LoB Mainstream Displays
620A Lorong 1, Toa Payoh
Singapore 319762

Federal Communications Commission Notice

This equipment has been tested and found to comply with the limits for a Class B digital device, pursuant to part 15 of the FCC Rules. These limits are designed to provide reasonable protection against harmful interference in a residential installation. This equipment generates, uses, and can radiate radio frequency energy and, if not installed and used in accordance with the instructions, may cause harmful interference to radio communications. However, there is no guarantee that interference will not occur in a particular installation. If this equipment does cause harmful interference to radio or television reception, which can be determined by turning the equipment off and on, the user is encouraged to try

to correct the interference by one or more of the following measures:

- Reorient or relocate the receiving antenna.
- Increase the separation between the equipment and the receiver.
- Connect the equipment into an outlet on a circuit different from that to which the receiver is connected.
- Consult the dealer or an experienced radio or television technician for help.

Modifications

The FCC requires the user to be notified that any changes or modifications made to this device that are not expressly approved by Philips Consumer Lifestyle may void the user's authority to operate the equipment.

Cables

Connections to this device must be made with shielded cables with metallic RFI/EMI connector hoods to maintain compliance with FCC Rules and Regulations.

Canadian notice

This Class B digital apparatus meets all requirements of the Canadian Interference-Causing Equipment Regulations.

Avis Canadien

Cet appareil numérique de la classe B respecte toutes les exigences du Règlement sur le matériel brouilleur du Canada.

Copyright



VESA, FDMI and the VESA Mounting Compliant logo are trademarks of the Video Electronics Standards Association.



Manufactured under license from Dolby Laboratories. 'Dolby' and the double D symbol are trademarks of Dolby Laboratories.



Manufactured under license from BBE Sound, Inc. Licensed by BBE, Inc under one or more of the following US patents: 5510752, 5736897. BBE and BBE symbol are registered trademarks of BBE Sound Inc.

© Kensington and Micro Saver are registered US trademarks of ACCO World Corporation with issued registrations and pending applications in other countries throughout the world. All other registered and unregistered trademarks are the property of their respective owners.

Portions of this software are copyright © The FreeType Project (www.freetype.org).

Contents

1. Important	5	Use your TV in HDTV mode	24
Product information	5	Use your TV as a PC monitor	24
Screen care	5	Use Philips EasyLink	25
Environmental care	5	Use the demo mode	25
Regulatory notices	5		
2. Your TV	6	6. Change your TV installation	26
Television overview	6	Select your menu language	26
Remote control	6	Set your location to home	26
		Tune channels automatically	26
		Optimize the signal quality from your antenna	26
		Uninstall and reinstall channels	27
		Return your settings to default values	27
		Show emergency alerts (EAS)	27
3. Get started	7	7. Update your TV software	28
Position the TV	7	Check your current software version	28
Install the remote control batteries	7	Prepare for the software upgrade	28
Connect the antenna or cable	7	Upgrade software	28
Connect the power cord	8	8. Connect devices	29
Manage cables	8	Connection overview	29
Switch on and setup the TV	9	Select your connection quality	30
		Label your connections	30
		Connect your devices	31
4. Use your TV	10	9. Glossary	34
Switch your TV on/off or to standby	10	10. Troubleshooting	35
Watch TV	10	11. Notes for the use of USB devices	36
Watch channels from a set-top box	11	12. Technical specifications	37
Watch connected devices	11	13. Index	38
Watch a DVD	11	14. Warranty	40
5. Use more of your TV	12		
Understand the remote control	12		
Use the quick access menu	13		
Change picture and sound settings	13		
Change Ambilight settings	15		
Use Auto Mode	16		
Create and use lists of favorite channels	16		
Set the clock	17		
Set the sleep timer	17		
Use child control and rating locks	18		
View closed captions (subtitles)	21		
View photos and play music on a USB device	22		

1. Important

Congratulations on your purchase and welcome to Philips!

To fully benefit from the support that Philips offers, register your product at www.philips.com/welcome.

Registering your model with Philips makes you eligible for all of the valuable benefits listed below, so don't miss out.

Complete and return your Product Registration Card at once, or register online at www.philips.com/welcome to ensure:

- **Proof of Purchase**

Returning the enclosed card guarantees that your date of purchase will be on file, so no additional paperwork will be required from you to obtain warranty service.

- **Product Safety Notification**

By registering your product you'll receive notification - directly from the manufacturer - in the rare case of a product recall or safety defect.

- **Additional Benefits of Product Ownership**

Registering your product guarantees that you'll receive all of the privileges to which you're entitled, including special money-saving offers.

 **Note:** Specifications and information are subject to change without notice.

 For further assistance, call the customer support service in your country.

- **TO OBTAIN ASSISTANCE IN THE U.S.A., PUERTO RICO, OR U.S. VIRGIN ISLANDS.** Contact Philips Customer Care Center at: 1-888-PHILIPS (1-888-744-5477)
- **TO OBTAIN ASSISTANCE IN CANADA.** Contact Philips Customer Care Center at:
1-800-661-6162 (French Speaking)
1-888-PHILIPS (1-888-744-5477) - (English or Spanish Speaking)

1.1 Product information

The model and serial number are on the rear of the TV and on the packaging.

This TV consumes minimal energy in standby mode to minimize environmental impact. The active power consumption is given on the type plate at the rear of the TV.

1.2 Screen care

- Turn off and unplug the power cord before cleaning the screen.
- Clean the screen with a soft, dry cloth. Do not use substances such as household cleaning agents as these may damage the screen.

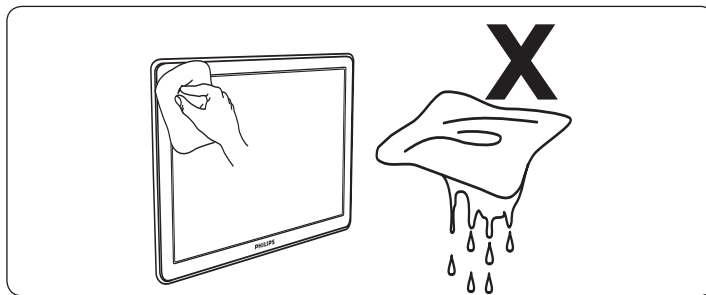

- To avoid deformations or color fading, wipe off water droplets as soon as possible.
- Do not touch, push, rub or strike the screen with hard objects as this may damage the screen permanently.
- Where possible, avoid stationary images that remain on-screen for extended periods of time. If you must use stationary images, reduce the screen contrast and brightness to avoid screen damage.

1.3 Environmental care



Recycling

The packaging of this product is intended to be recycled. Contact your local authorities for information about how to recycle the packaging.



End of life directives

Like all LCD products, this set contains a lamp with Mercury, please dispose of according to all Local, State and Federal laws.

Philips is paying a lot of attention to produce environmentally-friendly products in green focal areas. Your new TV contains materials which can be recycled and reused. At the end of its life, specialized companies can dismantle the discarded TV to concentrate the reusable materials and to minimize the amount of materials to be disposed off. Please ensure you dispose off your old TV according to local regulations.

Disposal of batteries

The batteries supplied do not contain the heavy metals mercury and cadmium. Nevertheless, in many areas batteries may not be disposed of with your household waste. Please ensure you dispose of batteries according to local regulations.

1.4 Regulatory notices

 **WARNING:** To reduce the risk of fire or electric shock, this apparatus should not be exposed to rain or moisture. Objects filled with liquids, such as vases, should not be placed on this apparatus.

 **CAUTION:** To prevent electric shock, match the wide blade of the plug to the wide slot, fully insert.

2. Your TV

This section describes the controls and functions of your TV.

2.1 Television overview

Front and side controls

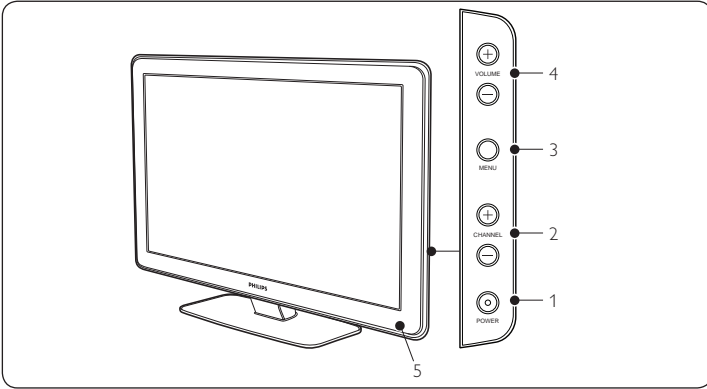

1. Power switch
2. Channel up/down
3. Menu
The **MENU** key can be used as an **OK** key in some submenus.
4. Volume up/down
5. Remote control sensor

Side connectors

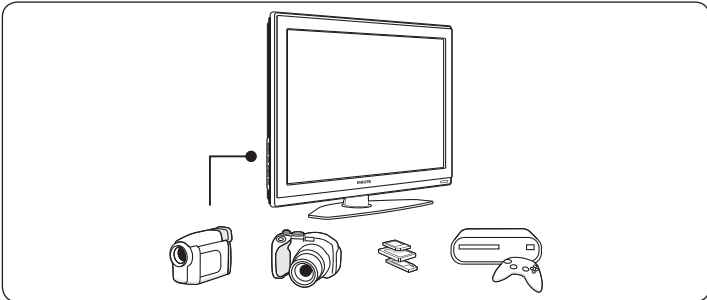

Use the TV side connectors to connect to mobile devices such as a camera or high definition game console. You can also connect a pair of headphones or a USB memory device.

Back connectors

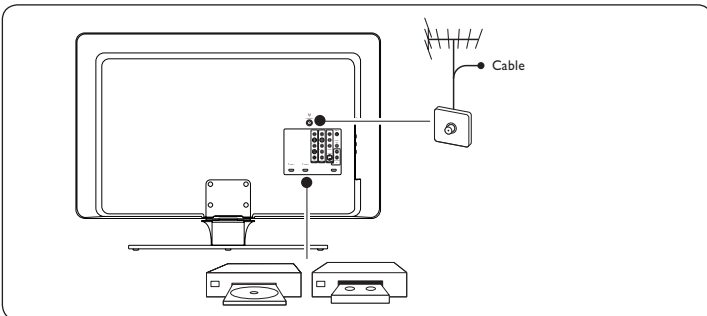

Use the TV back connectors to connect to the antenna or cable, and to permanent devices such as a high definition disc player, DVD player, or VCR.

For more information about TV connections, see *Connect your devices* on page 31.

2.2 Remote control

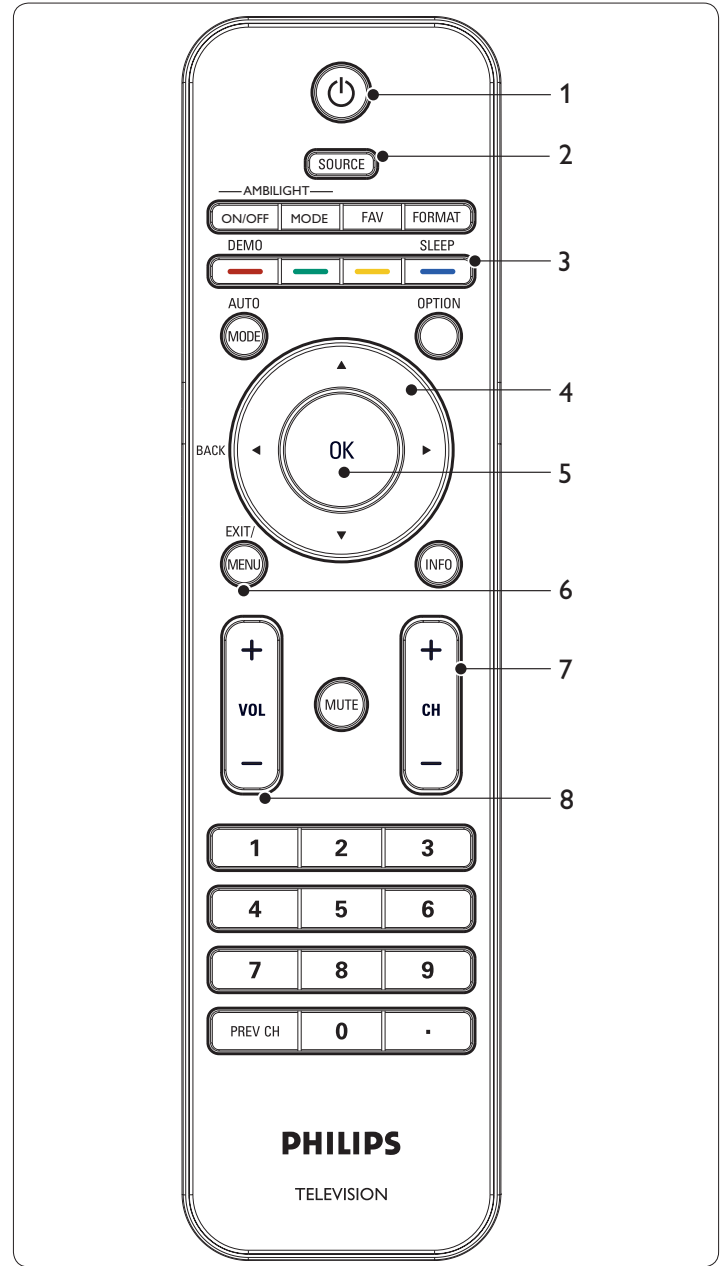

1. Standby / ON
2. Source selection
3. Color buttons
4. Cursor buttons
5. OK button
6. Menu button
7. Channel selection
8. Volume

For more information about the remote control, see *Understand the remote control* on page 12.

3. Get started

This section describes how to position and connect your TV, and how to perform your first-time installation.

3.1 Position the TV

⚠ Warning

- Do not insert the power plug into the wall socket before all the connections are made.
- Large screen TVs are heavy. Two people are required to carry and handle the TV.
- Before you move your TV, disconnect the cables to prevent breakage.

Wherever you decide to position your TV, ensure that you always have easy access to the power cord or plug to disconnect the TV from the power.

If the TV is mounted on a swivel base or swivel arm, ensure no strain is placed on the power cord when the TV is swivelled. Strain on the power cord can loosen connections.

For ideal viewing conditions, position the TV where light does not fall directly on the screen.

The ideal viewing distance for watching TV is three times its screen size.

Kensington security slot

Your TV is equipped with a Kensington Security Slot at the back of the TV.

If you connect an anti-theft Kensington lock (not supplied), position the TV within reach of a permanent object that can be attached to the lock.

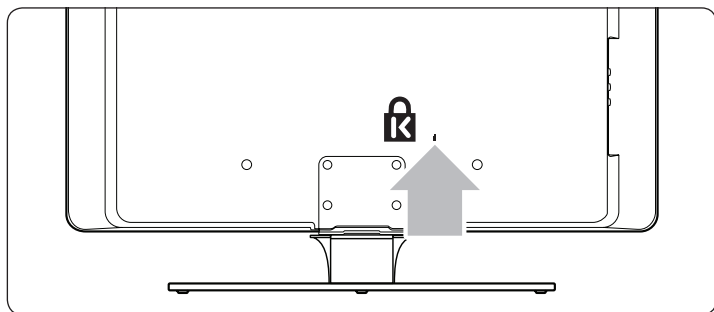

3.2 Install the remote control batteries

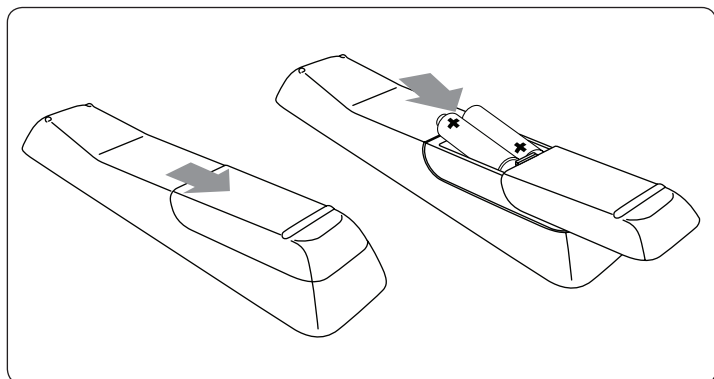

1. Open the battery cover on the back of the remote control.
2. Insert the 2 batteries supplied. Make sure the + and - ends of the

batteries line up correctly (inside of case is marked).

3. Close the cover.

ⓘ **Note:** If you are not going to use the remote control for a long time, remove the batteries.

3.3 Connect the antenna or cable

This section describes how to connect your TV to an antenna, cable, Direct Broadcast Satellite, and to a set-top box.

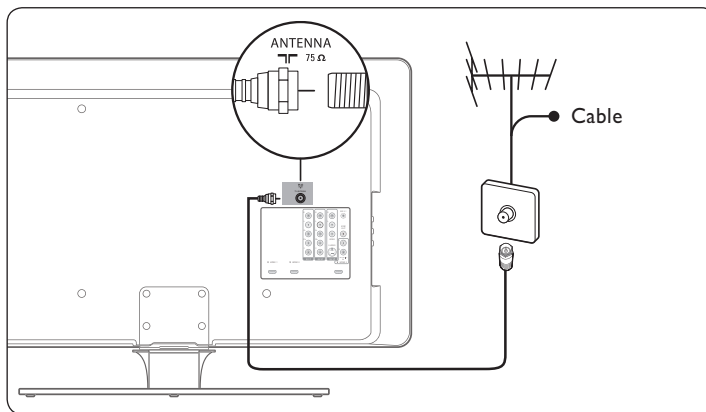

Connect to an antenna

Any DTV programs that are broadcast in your area can be received for free through an antenna connection.

Contact your local content provider or your local electronics retailer if you are unsure about what HDTV programs are available in your area.

Broadcasters are transitioning from analog to digital TV. This means that a given broadcaster can have channels available either in analog or in digital, or both analog and digital at the same time.

The TV has stereo sound if the broadcasting channel makes it available.

Connect to a cable

When your TV is connected to the cable socket, you may receive free digital and high definition programming (depending on your cable provider). Digital and high definition cable channels can be recognized by the format of the channel number. The channel number includes a dot "." For example, 11.1, 46.30, 108.201. Contact your cable provider for more information.

Connect to a Direct Broadcast Satellite (DBS)

There are two main DBS systems: DirecTV and DishNetwork. These systems require a separate, proprietary set-top box to decode signals and send them to the TV. The set-top box contains a digital TV tuner for receiving off-air digital television broadcasts.

Contact your local DBS provider for more information about the connections and the TV channels.

Connect to a set-top box

A cable box or satellite set-top box can be connected to the TV through the following connections:

- ANT
- A/V (Composite Video and Audio)
- S-Video

- YPbPr (Component Video Input)
- HDMI

For information about how to connect a set-top box, see the *Quick Start Guide* provided.

Connect a set-top box through RF IN/OUT

If the TV is connected to a cable box or satellite set-top box via a coaxial connection, set the TV to channel 3 and 4, or the channel specified by the service provider.

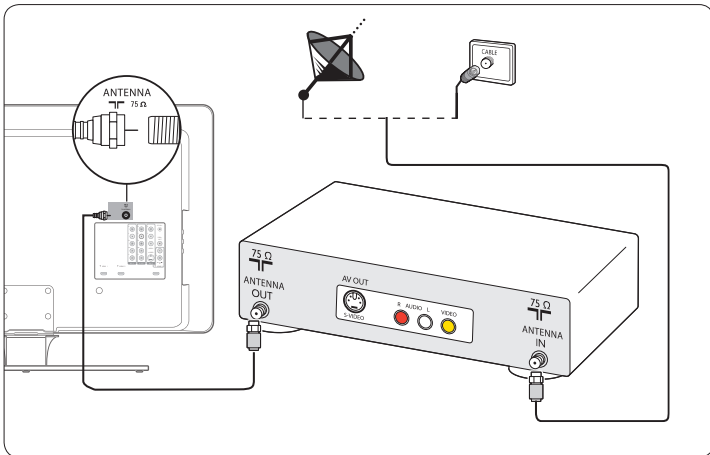

Connect a set-top box through component video input or HDMI

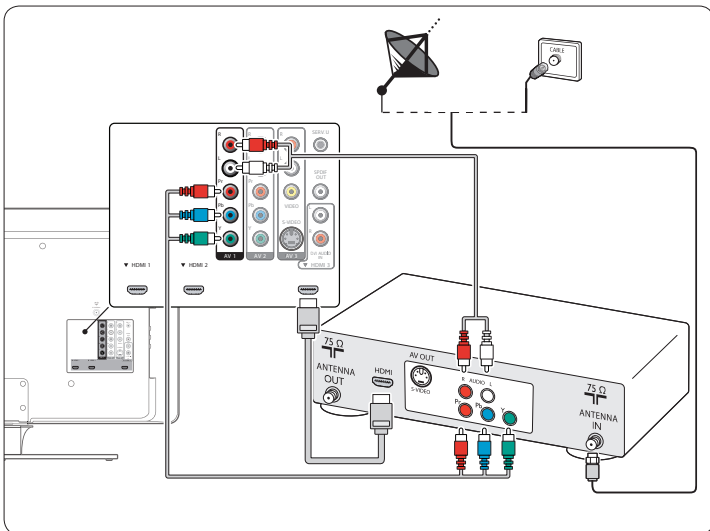

3.4 Connect the power cord

⚠ WARNING: Verify that your voltage corresponds with the voltage printed at the back of the TV. Do not insert the power cord if the voltage is different.

To connect the power cord

1. Locate the power connector at the back of the TV.

The location of the power connector varies according to TV model.

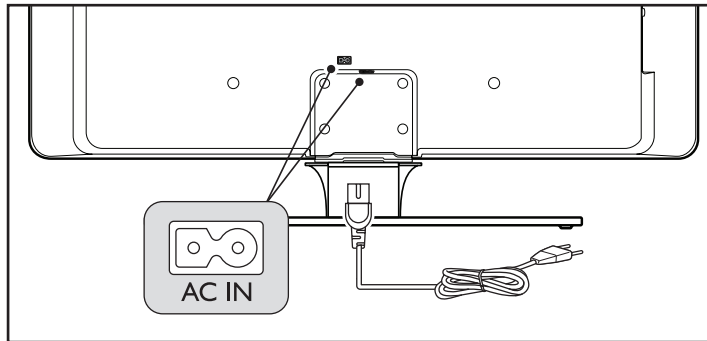

2. Insert the power cord fully into the TV power connector.
3. Connect the power cord plug to the power outlet. Ensuring that the cord is tightly secured at both ends.

To disconnect the TV from the power outlet

The TV set is always connected to the power. You can disconnect the TV from the power by doing one of the following tasks:

- Unplug the power cord located at the back of the TV.
- Unplug the power cord from the power socket outlet.

Pull the power cord by the plug - do not pull on the power cord.

3.5 Manage cables

Route your power cord, antenna cable and all other device cables through the cable holder at the back of the TV. This holder helps keep your cables tidy and easily manageable.

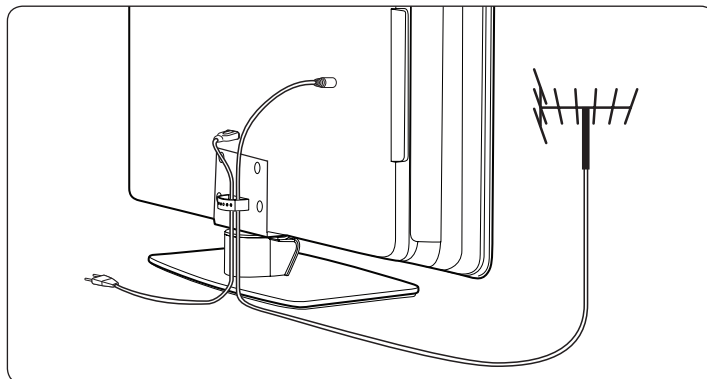

3.6 Switch on and setup the TV

The TV switches on automatically after connecting the power cord.

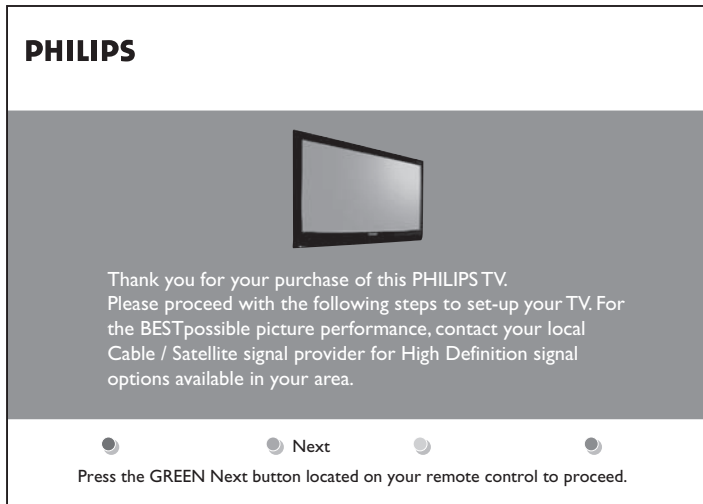

Follow the on-screen instructions to select your language and complete your TV setup. Installation takes approximately 10 minutes.

Note: If you connect your TV to a cable box or satellite set-top box, you do not need to install channels. Press the red button on the remote control to exit the channel installation stage of the setup.

Finish the setup by selecting your location:

- If you choose **Retail store** your settings will be are erased each time you turn off the TV. This mode is only to be used for retail store displays.
- If you choose **Home** you are guided through a choice of picture display options. Use the left and right cursor to select your preferred screen.

4. Use your TV

This section helps you perform basic TV operations.

4.1 Switch your TV on/off or to standby

To switch the TV on

- Press **POWER** at the right side of the TV.

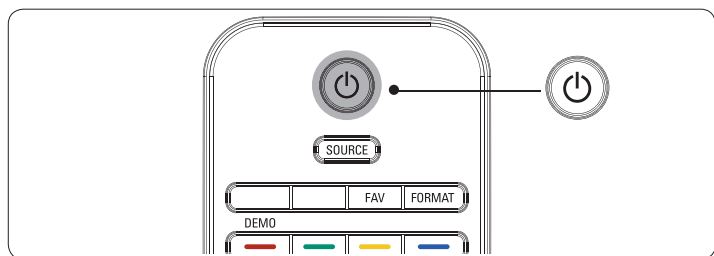
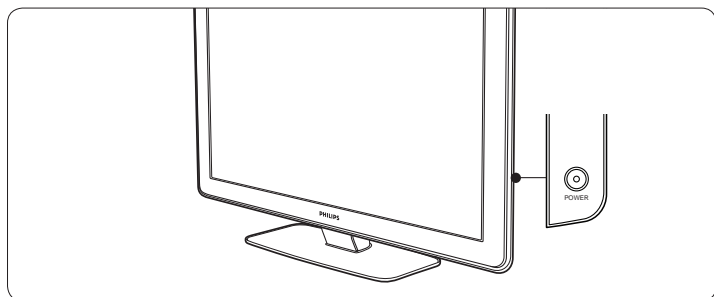

To switch to standby

- Press **POWER** on the remote control.

To switch on from standby without the remote control

- Press **POWER** at the right side of the TV to switch the TV off.
- Press **POWER** again to switch the TV on.

To switch off

- Press **POWER** at the right side of the TV.

Note

Energy consumption contributes to air and water pollution. When the power cord is plugged in, your TV consumes energy. Your TV has a very low standby power consumption.

4.2 Watch TV

Switch channels

- Press a number (1 to 999) or press **CH+** or **CH-** on your remote control.
For digital channels, press a number (1 to 999) followed by a dot "." and then the corresponding sub channel number (1 to 999). Ex. 108.30.
- Press **PREV CH** to return to the previously viewed TV channel.

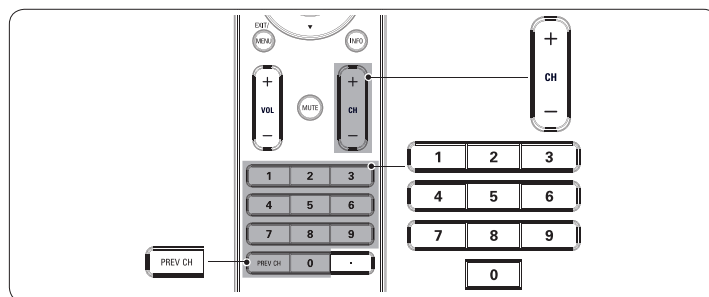

Note

You can also switch channels by pressing **CHANNEL -** or **+** on the side controls of the TV.

Adjust volume

- Press **VOL+** or **VOL-** on your remote control.
- Press **MUTE** on your remote control to mute the sound.
Press **MUTE** again or press **VOLUME -** or **+** to restore the sound.

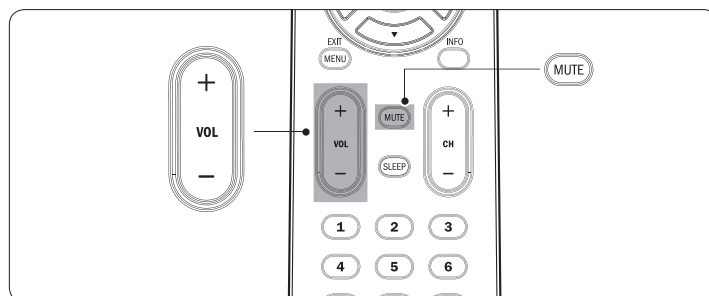

Note: You can also adjust the volume by pressing **VOLUME -** or **+** on the side controls of the TV.

To increase the headphone volume, press the volume button on the TV or remote control. When headphones are plugged into the TV, the loud speakers are automatically muted.

4.3 Watch channels from a set-top box

1. Switch on the set-top box.
The picture from your set-top box might appear automatically on your screen.
2. Use the remote control of your set-top box to select channels.

If the picture does not appear

1. Press **SOURCE** repeatedly to select the connected set-top box and wait a few seconds for the picture to appear.

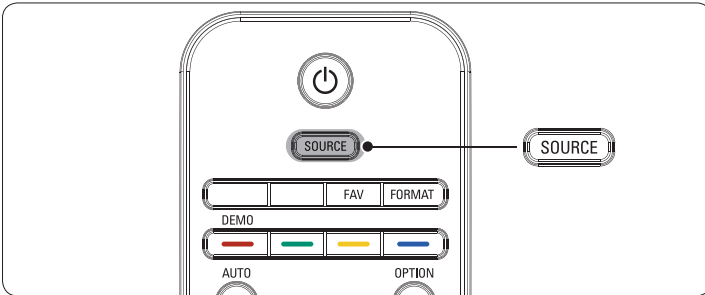

2. Use the remote control of your set-top box to select channels.

4.4 Watch connected devices

1. Switch the connected device on.
The picture from your connected device might appear automatically on the TV.

If the picture does not appear

1. Press **SOURCE** repeatedly to select the connected device and wait a few seconds for the picture to appear.

4.5 Watch a DVD

1. Insert a DVD disc in your player.
2. Press **Play ▶** on the remote control of your player.
The picture from the player might appear automatically on your screen.

If the picture does not appear

1. Press **SOURCE** repeatedly to select the DVD player and wait a few seconds for the picture to appear.

5. Use more of your TV

This section describes the advanced features of your TV.

5.1 Understand the remote control

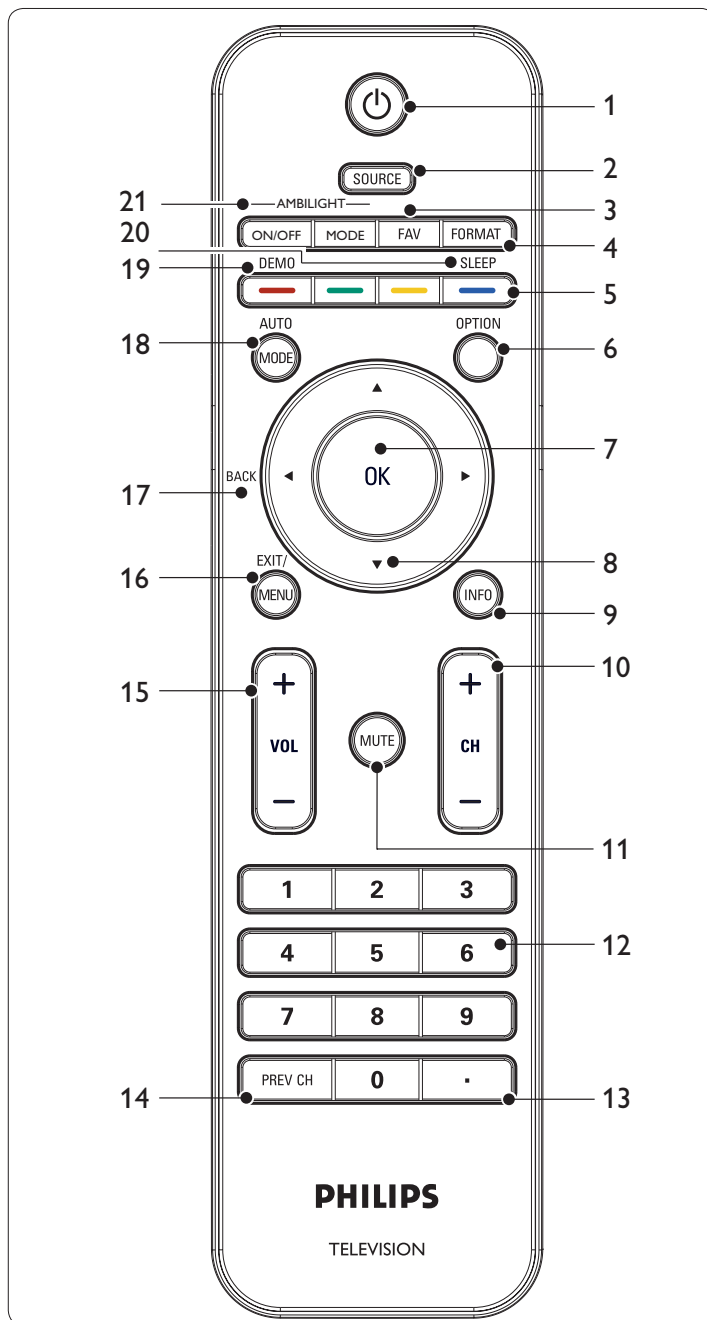

1. Switches the TV on from standby or back to standby. The TV is never powered off completely unless it is physically unplugged.
2. **SOURCE**
Selects connected devices.
3. **FAV**
To display a list of all channels marked as favorite (including subchannels).

4. **FORMAT**
Selects a picture format. See *Change picture format* on page 14.
5. **Color keys**
Selects tasks.
6. **OPTION**
Activates the quick access menu. For information, see *Use the quick access menu* on the next page.
7. **OK**
To display the channel list or to activate a setting.
8. **Cursor buttons** ◀ ▶ ▲ ▼
To navigate through the menus.
9. **INFO**
Press to display information about the selected TV channel and program or accessory device. The quality and accuracy of the information on the information banner are transmitted from broadcasters. You may see a difference in broadcast time if the broadcaster is from a different time zone area.
10. **+ CH** - Channel up/down
Switches to the next or previous channel.
11. **MUTE**
Mutes or restores sound.
12. **Number keys 0-9**
Selects a channel, page or setting.
13. **(.)**
Press the dot (.) for digital channels.
14. **PREV CH**
Returns to the previously-viewed channel.
15. **+VOL-** Volume up/down
Increases or decreases volume.
16. **MENU / EXIT**
Toggles the menu on or off.
17. **BACK**
To return to the previous menu.
18. **AUTO MODE**
Toggles between preset picture and sound settings. For information, see *Use Auto Mode* on page 16.
19. **DEMO**
Toggles the demo menu on or off. For information, see *Use the demo mode* on page 25.
20. **SLEEP**
To set a delay after which the TV switches to standby. For information, see *Set the sleeptimer* on page 17.
21. **AMBILIGHT**
Switches Ambilight on or off and sets the mode. See *Change Ambilight settings* on page 15.

5.2 Use the quick access menu

The quick access menu gives direct access to some often needed menu items.

Note

When digital channels are installed and broadcast, the relevant digital options are displayed in the quick access menu.

1. Press **OPTION** on the remote control.

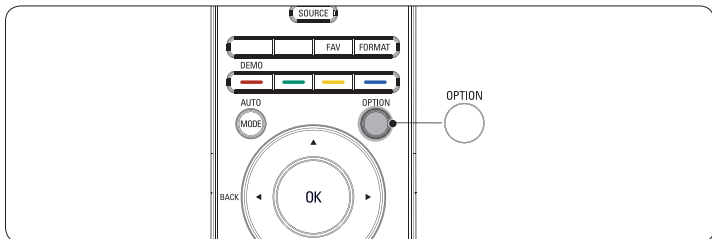

2. Press **▲** or **▼** and then **OK** to access one of the following menus:

- **Audio language**
For digital channels only, where multiple audio languages are broadcast.
- **Closed captions**
See *View closed captions (subtitles)* on page 21.
- **Picture format**
See *Change picture format* on the next page.
- **Equalizer**
See *Change sound settings* on page 15.
- **Clock**
See *Set the clock* on page 17.

3. Press **▼** and **▶** to select the **Picture** menu.

PHILIPS	
TV menu	Picture
Settings assistant	Contrast
Picture	Brightness
Sound	Color
Ambilight	Tint
	Sharpness
	Color temperature
	Dynamic contrast
	HD Natural Motion*

*Available in selected models

4. Press **▲** or **▼** to select one of the picture settings, and press **▶** to enter the setting.
5. Press **▲** or **▼** to adjust the setting, and press **◀** or **OK** to confirm the change.
6. Press **Menu** to exit.

Change picture settings by using the setting assistant

This section guides you through a picture settings wizard.

1. Press **MENU** on the remote control.

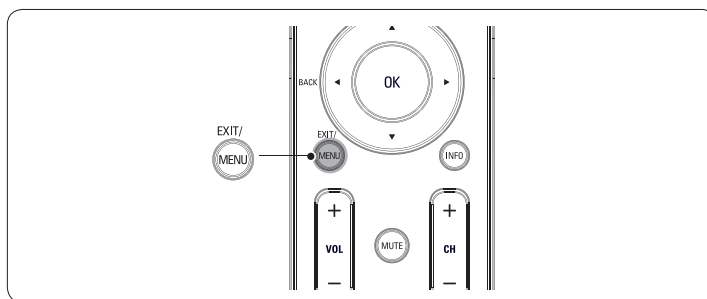

2. Press **▶** to enter the **Settings assistant** menu.

PHILIPS	
TV menu Installation	Settings assistant
Settings assistant	Start now
Picture	
Sound	
Ambilight	

3. Press **▶** to highlight **Start now**, and press **OK** to start the Settings assistant.

You are guided through a choice of picture display options. Press the color keys, cursor keys and **OK** to make your selections and store your setup.

5.3 Change picture and sound settings

Change picture settings

This section describes how to adjust your picture settings.

1. Press **MENU** on the remote control.

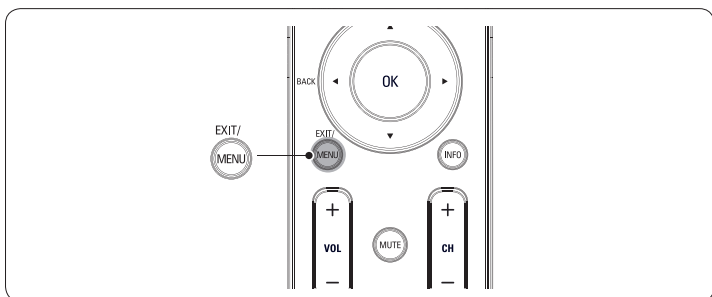

2. Press **▶** to enter the **TV settings** menu.

PHILIPS	
TV menu	TV settings
TV settings	Settings assistant
Features	Picture
Installation	Sound
	Ambilight

Summary of picture settings

The following picture settings can be configured. Depending on the format of the picture source, some picture settings might not be available.

- **Contrast** - Sets the level of white in the picture.
- **Brightness** - Sets the brightness of the picture.
- **Color** - Sets the level of saturation.
- **Tint** - Adjusts the color balance between red and green.
- **Sharpness** - Sets the sharpness of fine details.
- **Color temperature** - Sets the color temperature to normal, warm or cool.
- **Dynamic contrast** - Enhances contrast in the darker and the brighter picture areas as the image on the screen changes.
- **HD Natural Motion (HDNM)** - In selected TV models only. Reduces field and line flicker to display movement smoothly. You can switch HDNM on or off.
- **Digital Noise Reduction (DNR)** - Automatically filters out and reduces image noise and improves picture quality when receiving weak video signals. You can switch DNR on or off.
- **MPEG artifact reduction** - Smooths transitions on digital pictures. You can switch MPEG artefact reduction on or off.
- **Color enhancement** - Makes colors more vivid and improves the resolution of details in bright colors. You can switch color enhancement on or off.
- **Active control** - Corrects incoming signals to provide the best picture possible according to lighting conditions in the room. You can switch Active Control to one of these settings: **Off**, **On with light sensor** or **On without light sensor**.
- **Picture format** - Changes the format of the picture.
- **Horizontal shift** - Adjusts the horizontal position of the picture.
- **Vertical shift** - Adjusts the vertical position of the picture.

Change picture format

1. Press **FORMAT** on the remote control.

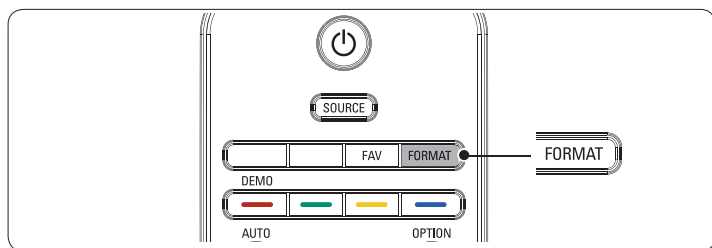

2. Press **▲** or **▼** to select a picture format and press **OK** to confirm your choice.

Summary of picture formats

The following picture formats can be selected. Depending on the format of the picture source, some picture formats might not be available.

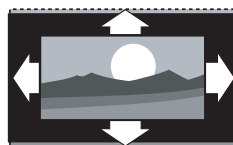

Automatic

(Not for PC mode.)

Enlarges the picture automatically to best fit the screen. The subtitles remain visible.

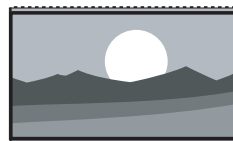

Super zoom

(Not for HD and PC mode.)

Removes the black bars on the side of 4:3 broadcasts. There is minimal distortion.

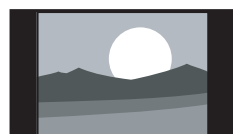

4:3

Shows the classic 4:3 format.

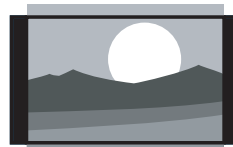

Movie expand 14:9

(Not for HD and PC mode.)

Scales classic 4:3 format to 14:9.

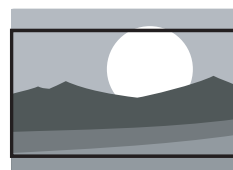

Movie expand 16:9

(Not for HD and PC mode.)

Scales the classic 4:3 format to 16:9.

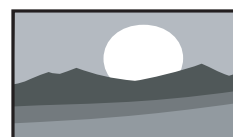

Wide screen

Stretches the classic 4:3 format to 16:9

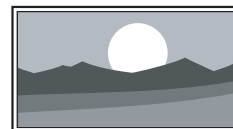

Unscaled (In selected TV models only)

(For HD and PC mode only)

Allows maximum sharpness. Some distortion may be present due to the broadcaster's systems. Set your PC resolution to widescreen mode for best results.

Change sound settings

This section describes how to adjust your sound settings.

1. Press **MENU** on the remote control and select **TV settings > Sound**.

TV menu		PHILIPS
TV Settings	Sound	
Settings assistant	Equalizer	
Picture	Balance	
Sound	Digital audio language	
Ambilight	Alternate audio	
	Mono/Stereo	
	Incredible sound	
	AVL	
	BBE	

2. Press **▲** or **▼** to highlight a sound setting and press **▶** to select the setting.
3. Press **▲** or **▼** to adjust the setting, and press **OK** to confirm the change.
4. Press **Menu** to exit.

Summary of sound settings

The following sound settings can be configured. Depending on the sound source, some sound settings might not be available.

- **Equalizer**
Changes the bass and treble. Select a bar to change the setting.
- **Balance**
Sets the balance of the left and right speakers.
- **Digital audio language**
Available for digital channels only, when multiple languages are broadcast. Lists available audio languages.
- **Alternate audio**
Available for analog channels only when a main and second audio program (SAP) is available from the broadcaster. Select the main or second audio program.
- **Mono/Stereo**
Select mono or stereo.
- **Incredible surround**
Sets modes for spatial or surround sound reproduction depending on the broadcast signal or on signals from external input. Select on or off.
- **Automatic volume leveling (AVL)**
Reduces sudden volume changes, for example, during commercials or when switching from one channel to another. Select on or off.
- **BBE**
Restore clarity for better speech intelligibility and musical realism. Select on or off.
- **Delta volume**
Levels out volume differences between channels or connected devices. Switch to the connected device as described in *Watch connected devices* on page 11 before changing the Delta volume.

5.4 Change Ambilight settings

This section describes how to adjust your Ambilight settings.

Turn Ambilight on/off

1. Press **AMBILIGHT ON/OFF** on the remote control.
2. Press **AMBILIGHT MODE** to toggle between Ambilight modes.

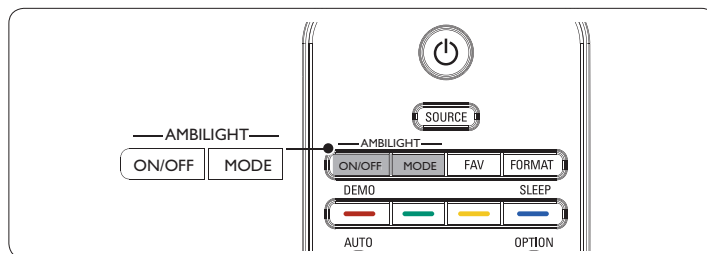

Configure Ambilight

1. Press **MENU** on the remote control and select **TV settings > Ambilight**.

TV menu		PHILIPS
TV Settings	Ambilight	
Settings assistant	Ambilight	
Picture	Brightness	
Sound	Mode	
Ambilight	Color	
	Custom color	
	Balance	

2. Press **▲** or **▼** to highlight a setting and press **▶** to select the setting.
3. Press **▲** or **▼** to adjust the setting, and press **OK** to confirm the change.
4. Press **Menu** to exit.

Summary of Ambilight settings

- **Ambilight**
Switches Ambilight on or off.
- **Brightness**
Changes the light output of Ambilight.
- **Mode**
Choose from four Ambilight modes.
- **Color**
Selects a predefined color setting or allows you to make a custom color.
Custom color
Allows you to customize a color. Select **Saturation** first and set the value high. Then select **Palette** and choose a value from 0 to 100.
- **Balance**
Sets the level of Ambilight on the left and right side of the TV.

5.5 Use Auto Mode

1. Press **Auto Mode** to set your TV to a predefined picture and sound setting.

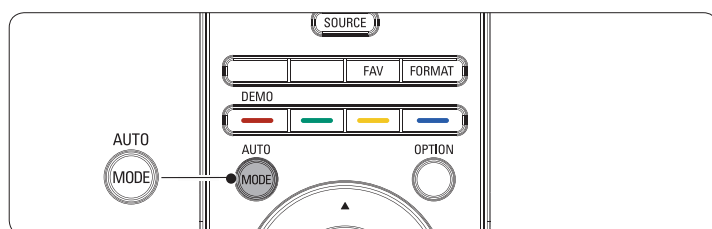

2. Press **▲** or **▼** to select one of the following settings:
 - **Personal**
The customized settings you defined by using the **Picture** menu.
 - **Sports**
Vivid picture settings and clear sound for high action.
 - **Standard**
For normal TV viewing.
 - **Movie**
Brilliant picture settings for a cinematic experience.
 - **Game**
Optimized for PCs, games consoles and playstations.
 - **Power saver**
Eco friendly settings for lower power consumption.

5.6 Create and use lists of favorite channels

This section describes how to create and use lists of your favorite channels.

Select a list of favorite channels

1. Press the **FAV** key on the remote control.

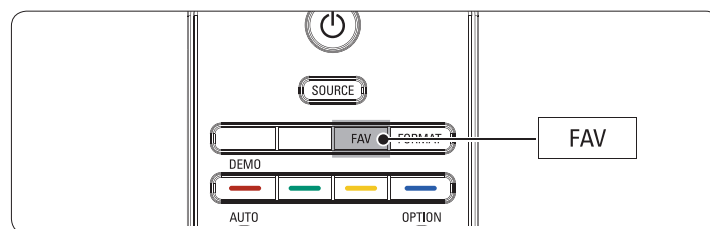

Your lists of favorite channels are displayed.

2. Press **▲** or **▼** to highlight a list, and press **OK** to select the list.

Create or edit a list of favorite channels

1. Press the **FAV** key on the remote control to display your lists of favorite channels.
2. Press **▲** or **▼** to highlight a list, and press **OK** to select the list.
3. Press the green key to enter **Edit** mode.
A list of channels is shown.
4. Press **▲** or **▼** to highlight a channel.
5. Press **OK** to select or deselect the highlighted channel.
The channel is added to or removed from the list of favorite channels.
6. Press the green key to exit.

Switch to one of the channels on a list

1. Press the **OK** key on the remote control to display the last list that you selected.
2. Press **▲** or **▼** to highlight a channel.
3. Press **OK** select the channel.
The TV switches to that channel.

5.7 Set the clock

This section describes how to set the time, date, time zone, and daylight saving.

Set the time automatically

Some digital channels transmit the time. For these channels, you can set the time automatically. Follow these steps to set the time automatically and to choose which channel to read the time from.

1. Press **MENU** on the remote control and select **Installation > Clock > Auto clock mode**.
2. Select **Automatic**, and press **◀** to confirm your choice.

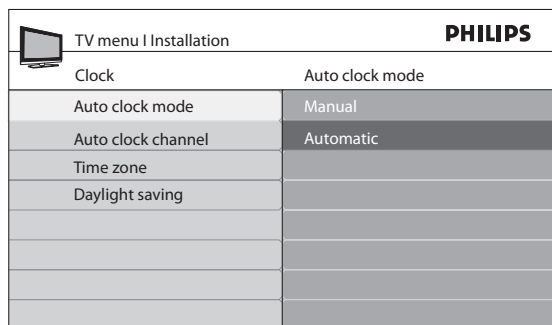

3. (Optional) Select the channel from which the TV will read the time.
 - Press **▼** and **▶** to enter the menu for **Auto clock channel**.
 - Press **▲** or **▼** to highlight a channel.
 - Press **◀** to confirm your choice.
4. (Optional) Select the time zone.
 - Press **▼** and **▶** to enter the menu for **Time zone**.
 - Press **▲** or **▼** to highlight the time zone.
 - Press **◀** to confirm your choice.
5. (Optional) Set daylight saving.
 - Press **▼** and **▶** to enter the menu for **Daylight saving**.
 - Press **▲** or **▼** to highlight **Automatic** or **Off**.
 - Press **◀** to confirm your choice.
6. Press **MENU** to exit.

Set the time manually

1. Press **MENU** on the remote control and select **Installation > Clock > Auto clock mode**.
2. Press **▲** or **▼** to select **Manual**, and press **◀** to confirm your choice.

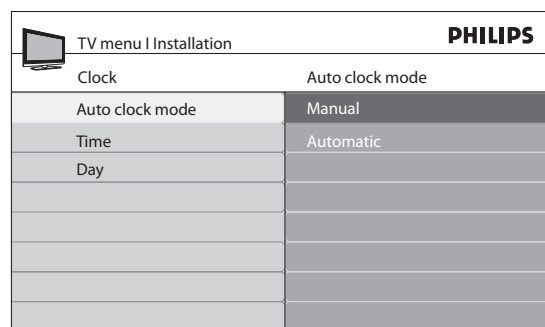

3. Press **▼** to select **Time** and then press **▶** to set the time. Use the format HH:MM. Select **AM/PM** for morning or afternoon.
4. Press **OK** to confirm your choice.
5. Press **▼** and **▶** to enter the menu for **Day**.
6. Press **▲** or **▼** to select the day.
7. Press **OK** to confirm your choice.
8. Press **MENU** to exit.

5.8 Set the sleeptimer

This section describes how to program the TV to switch off automatically after a delay.

1. Press **MENU** on the remote control and select **Features > Sleptimer**.

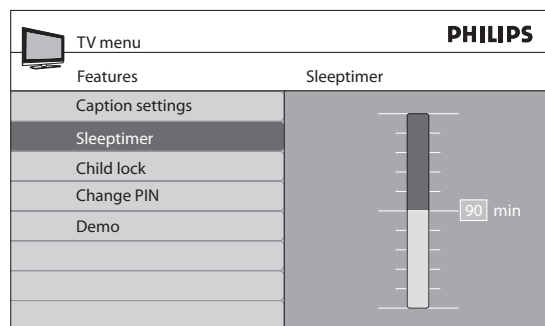

2. Press **▲** or **▼** to select a value from **0** to **180** minutes. For example, when you select **90**, the TV switches to standby in 90 minutes.
3. Press **MENU** to exit.

Tip
To turn the sleeptimer off, select **0** minutes.

5.9 Use child control and rating locks

This section describes how to lock or unlock the TV. You can set a personal identification number (PIN) and prevent your children from watching certain programs or certain channels.

Set or change your PIN

1. Press **MENU** on the remote control and select **Features > Change PIN**.
2. Enter a 4-digit PIN with the number keys on the remote control.
 - If you have a PIN, enter your current PIN.
 - If you do not have a PIN or if you have lost your PIN, enter **0711**.
3. Enter your new 4-digit PIN and then enter it again to confirm. A message appears to confirm that your PIN has been changed.
4. Press **MENU** to exit.

Lock the TV

This section describes how to lock all channels on the TV. At the specified time, screen is blanked out and the audio is muted.

1. Ensure that the clock is set with the current time. For information about how to set the clock, see *Set the clock* on the previous page.
2. Press **MENU** on the remote control and select **Features > Child lock > Lock after**.
3. Enter your PIN.
If you do not have a PIN, set one as described in *Set or change your PIN* on this page.
4. Press **▶** to select **Timer**.

TV menu Features Child lock		PHILIPS
Lock after	Timer	
Timer	Off	
Time	On	

5. Press **▼** to select **On** and activate the **Lock after** feature. Selecting **Off** deactivates the feature.
6. Press **◀** to confirm your choice.
7. Press **▼** to select **Time** and then press **▶** to set the time. Use the format HH:MM. Select **AM/PM** for morning or afternoon.
8. Press **OK** to confirm the time.
9. Press **MENU** to exit.
10. Please restart your TV to activate this function.

Lock a channel

This section describes how to lock specified channels. The channels can be selected but the screen is blanked out and the audio is muted.

1. Press **MENU** on the remote control and select **Features > Child lock > Channel lock**.
2. Enter your PIN.

If you do not have a PIN, set one as described in *Set or change your PIN* on this page.

TV menu Features		PHILIPS
Child Lock	Channel lock	
Lock after	<input type="checkbox"/>	Channel 1 Sport
Channel lock	<input type="checkbox"/>	Channel 2 News
TV ratings lock	<input type="checkbox"/>	Channel 3 Movies
Movie ratings lock	<input type="checkbox"/>	Channel 4
Canada English ratings lock	<input type="checkbox"/>	Channel 5
Canada French ratings lock	<input type="checkbox"/>	Channel 6
Region ratings lock	<input type="checkbox"/>	Channel 7

3. Press **▲** or **▼** and then press **OK** to lock one or more channels or external sources.
Each channel has a box-graphic in front of it to indicate whether it is locked:
 - A box with **X** indicates that the channel is locked
 - An empty box indicates that the channel is not locked
4. Press **MENU** to exit.

Use the TV ratings lock

Your TV is equipped with a V-chip that allows you to control access to individual programs based on their age rating and content rating. The program content advisory data are sent by the broadcaster or by the program provider.

If you are receiving channels through a set-top box or cable box connected by HDMI, you cannot use the TV ratings lock. Your set-top box or cable box must be connected through RF or AV connectors.

1. Press **MENU** on the remote control and select **Features > Child lock > TV ratings lock**.

2. Enter your PIN.

If you do not have a PIN, set one as described in *Set or change your PIN* on the previous page.

3. Press **▲** or **▼** and then press **OK** to lock or unlock one or more ratings.

Each rating has a box-graphic in front of it to indicate whether programs carrying that rating are currently locked:

- A box with **X** indicates that all items in the content ratings list are locked.
- An empty box indicates that the item is not selected.
- A box with **/** indicates that some content ratings are deselected. For example, for rating TV-14, you can deselect one or more of the following content ratings: Dialog (D), Language (L), Sex (S), or Violence (V).

TV ratings lock		TV-14
<input type="checkbox"/> All	<input type="checkbox"/> (D)Dialog	
<input type="checkbox"/> None	<input checked="" type="checkbox"/> (L)Language	
<input type="checkbox"/> TV-Y	<input checked="" type="checkbox"/> (S)Sex	
<input type="checkbox"/> TV-Y7	<input checked="" type="checkbox"/> (V)Violence	
<input type="checkbox"/> TV-G		
<input type="checkbox"/> TV-PG		
<input checked="" type="checkbox"/> TV14		
<input checked="" type="checkbox"/> TV-MA		

- When you select **All**, all items in the ratings list are locked.
- When you select **None**, programs with no rating and programs with a rating of **None** are locked.
- When you lock a rating, all ratings in the younger age categories are automatically locked.

4. Press **MENU** to exit.

Summary of TV ratings

Age rating	Content rating
All	None
None	None
TV-Y Appropriate for children of all ages with themes and elements suitable for children aged 2-6.	None
TV-Y7 Programs designed for children age 7 and older.	Fantasy Violence (FV)
TV-G Programs suitable for all ages. These programs contain little or no violence, no strong language and little or no sexual dialog or situations.	None
TV-PG Programs contain elements that some parents may find unsuitable for younger children and which may need parental guidance. The program may contain moderate violence, sexual dialog and/or situations and some strong language.	Dialog (D) Language (L) Sex (S) Violence (V)
TV-14 Programs contain elements that may not be suitable for children under 14 years of age. These programs include one or more of the following: intense violence, intense sexual situations, suggestive dialog and strong language.	Dialog (D) Language (L) Sex (S) Violence (V)
TV-MA Programs are designed to be viewed by adults and may be unsuitable for children under the age of 17. These programs may contain graphical violence, explicit sexual activity and/or crude or indecent language.	Language (L) Sex (S) Violence (V)

Use the movie ratings lock

This section describes how to control viewing of movies based on their Motion Picture Association of America (MPAA) rating.

- Press **MENU** on the remote control and select **Features > Child lock**.
- Select one of the menus for movie ratings lock.
 - In the USA, select **Movie ratings lock**.
 - In Canada, select **Canada English ratings lock** or **Canada French ratings lock**.
- Enter your PIN.

If you do not have a PIN, set one as described in *Set or change your PIN* on page 18.

The following screen shows the ratings in **Movie ratings lock**.

TV menu Features PHILIPS	
Child Lock	Movie ratings lock
Lock after	<input checked="" type="checkbox"/> All
Channel lock	<input checked="" type="checkbox"/> NR
TV ratings lock	<input type="checkbox"/> G
Movie ratings lock	<input checked="" type="checkbox"/> PG
Canada English ratings lock	<input checked="" type="checkbox"/> PG-13
Canada French ratings lock	<input checked="" type="checkbox"/> R
Region ratings lock	<input checked="" type="checkbox"/> NC-17
	<input checked="" type="checkbox"/> X

- Press **▲** or **▼** and then press **OK** to lock or unlock one or more movie ratings.

Each rating has a box-graphic in front of it to indicate whether it is locked:

- A box with **X** indicates that the rating is locked
- An empty box indicates that the rating is not locked

When you lock a movie rating, all items for ages below that movie rating are automatically locked.

- Press **MENU** to exit.

Summary of US movie ratings

Movie rating	Description
All	All items in the ratings list are locked.
NR	Not rated.
G	Movies with a mild content, suitable for all ages.
PG	Movies for which parental guidance is recommended. They may contain a few racy or violent scenes or maybe some bad language.
PG -13	Movies for which parental guidance may be recommended if under age 13.
R	Restricted. The movies usually contain offensive sex or bad language and may be unsuitable for children under the age of 17. Parental guidance or permission needed.
NC-17	Even with parental permission, forbidden under age 17. More offensive sex, violence or bad language.
X	Movies which generally focus on sex, violence and/or bad language. Also known as pornography.

Summary of Canadian movie ratings

Movie rating	Description
All	All items in the ratings list are locked.
C	Programming suitable for children under the age of 8 years. No profanity or sexual content of any level allowed. Minimal comedic violence.
C8+	Suitable for children ages 8 and over. Low intensity violence and fantasy horror allowed.
G	Movies with a mild content, suitable for all ages.
PG	Movies for which parental guidance is recommended. They may contain a few racy or violent scenes or maybe some bad language.
14+	Programming intended for children ages 14 and over. May contain intense scenes of violence, strong profanity, and depictions of sexual activity within the context of a story.
18+	Programming intended for viewers ages 18 and over. May contain strong violence, language, and sexual activity.

Summary of Canadian French movie ratings

Movie rating	Description
All	All items in the ratings list are locked.
G	Appropriate for all ages with little or no violence and little to no sexual content.
8 ans+	Appropriate for children 8 and up which may contain little violence, some foul language and/or little to no sexual content.
13 ans+	Appropriate for children 13 and up, with moderate violence, language, and some sexual situations. Persons under 13 should be accompanied by an adult.
16 ans+	Appropriate for children 16 and up, with strong violence, strong language, and strong sexual content.
18 ans+	Only to be viewed by adults and contains extreme violence and graphic sexual content/pornography.

Use the region ratings lock

This section describes how to control access to digital programs based on downloaded region ratings.

Before you download a ratings table, ensure that regional ratings are broadcast.

1. Press **MENU** on the remote control and select **Installation > Preferences > Downloaded rating table**.

TV menu Installation PHILIPS	
Preferences	Downloaded rating table
Location	Off
Show emergency alerts	On
Downloaded rating table	

2. Press **▲** or **▼** to select **On**, and press **◀** to confirm your choice. If you select **Off**, you choose not to download the region rating table and you cannot use the region rating lock.
3. Press **◀** to return to the TV menu and select **Features > Child lock > Region ratings lock**.

TV menu Features PHILIPS	
Child Lock	Region ratings lock
Lock after	
Channel lock	Please enter your PIN
TV ratings lock	
Movie ratings lock	
Canada English ratings lock	
Canada French ratings lock	
Region ratings lock	

4. Enter your PIN.
If you do not have a PIN, set one as described in *Set or change your PIN* on page 18.
5. Press **▲** or **▼** and then press **OK** to lock or unlock one or more ratings.
Each rating has a box-graphic in front of it to indicate whether it is locked:
 - A box with **X** indicates that the rating is locked
 - An empty box indicates that the rating is not locked
6. Press **MENU** to exit.

5.10 View closed captions (subtitles)

The caption service displays transmitted CC-, T-, and CS- text. The caption text can be displayed permanently or only when the TV is muted. This section describes how to use the caption service.

Note

- This television provides a display of television closed captioning that conforms with the EIA-608 standard and in accordance with Sections 15.119 of the FCC rules.
- If you connect your set-top box via HDMI or component video input, you cannot select closed caption through the TV. You can select closed caption through the set-top box only.
- The captions do not always use correct spelling and grammar.
- Not all TV programs and product commercials include closed caption information. Refer to your area TV program listings for the TV channels and times of closed caption shows. The captioned programs are usually noted in the TV listings with service marks such as 'CC'.

Display captions

1. Press **MENU** on the remote control and select **Features > Caption settings > Closed captions**.
2. Press **▲** or **▼** to select **On**, **Off** or **On during mute**, and press **◀** to confirm your choice.
3. Press **MENU** to exit.

Select caption services

For information about the caption services see *Summary of caption services* on the next page.

1. Turn captions on as described in *Display captions* on this page.
2. Select a caption service for analog channels:
 - Press **MENU** on the remote control and select **Features > Caption settings > Caption service**.
 - Press **▲** or **▼** to select one of the listed caption services and press **◀** to confirm your choice.
Not all caption services are necessarily being used by a TV channel during the transmission of a closed caption program.
3. Select a caption service for digital channels:
 - Press **▼** and **▶** to enter the menu for **Digital caption service**.
 - Press **▲** or **▼** to select one of the listed caption services, and press **◀** to confirm your choice.
4. Press **MENU** to exit.

Summary of caption services

- **CC-1, CC-2, CC-3, and CC-4**

Dialog and descriptions for the action on the captioned TV program show on screen. Usually **CC 1** is the most used. **CC 2** can be used for alternate languages if they are being transmitted.

- **T-1, T-2, T-3 and T-4**

Often used for channel guide, schedules, bulletin board information for Closed Captions programs, news, weather information, or stock market reports.

- **CS-1, CS-2, CS-3, CS-4, CS-5 and CS-6**

Service 1 is designated as the Primary Caption Service. This service contains verbatim, or near-verbatim captions for the primary language being spoken in the accompanying program audio.

Service 2 is designated as the Secondary Language Service. This service contains captions in a secondary language which are translations of the captions in the Primary Caption Service. The other service subchannels are not pre-assigned. It is up to the discretion of the individual caption provider to utilize the remaining service channels.

Choose how digital captions are displayed

You can define the size, font, color, background and other characteristics of the caption text.

1. Press **MENU** on the remote control and select **Features > Caption settings > Digital caption options**.
2. Press **▲** or **▼** to highlight an option for digital captions, and press **▶** to select the option.
3. Press **▲** or **▼** to highlight a setting for the option, and press **◀** to confirm your choice.
4. Press **MENU** to exit.

5.11 View photos and play music on a USB device

Your TV is fitted with a USB connection that enables you to view photos or listen to music stored on a USB device. You can view your pictures as a slideshow or listen to a music playlist.

For information about using a USB device, see *Notes for the use of USB devices* on page 36.

The following formats are supported:

- For pictures: JPEG
- For audio: MP3
- FAT/DOS-formatted memory devices

The following formats are NOT supported

- Progressive JPEG files
- Files with names exceeding 128 characters
- Files with names containing a dot character

ⓘ Note

- Philips can not be held responsible if your USB device is not supported, nor will Philips accept any liability for damage or loss of stored data.
- The USB device is not supplied with the TV.

Insert a USB device

1. While your TV is on, connect your USB device to the USB port on the side of your TV. The main menu appears automatically and the name of the USB device is highlighted next to **Multimedia**.

PHILIPS	
TV menu	Multimedia
TV settings	MyUSB
Features	
Installation	
Multimedia	

Remove a USB device

⚠ Caution

To avoid damaging the USB device always exit the on-screen menu and wait five seconds before you remove the USB device.

1. Press **Menu** to exit the on-screen menu.
2. Wait five seconds then remove the USB device.

View your pictures on a USB device

1. After connecting your USB device to the TV, press ► to enter the **Multimedia** menu. **Picture** is highlighted.

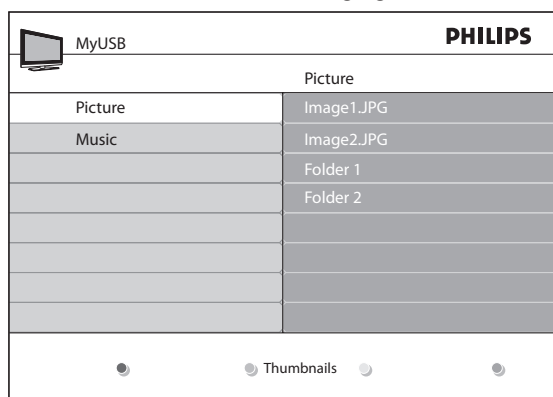

2. Press ► to enter the **Picture** folder.
3. Press ▲ or ▼ to select a picture or a picture album on the USB device.

The pictures appear in a list or as thumbnails. Press the green key to toggle between **List** and **Thumbnails**.

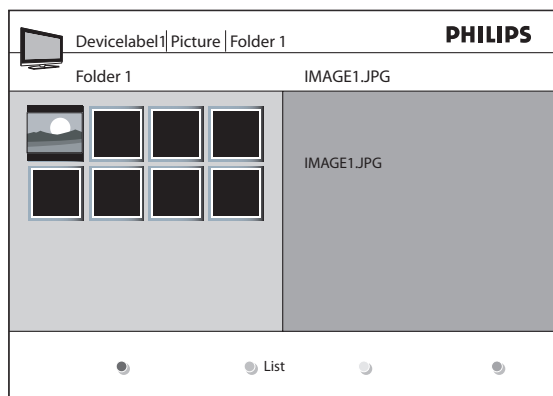
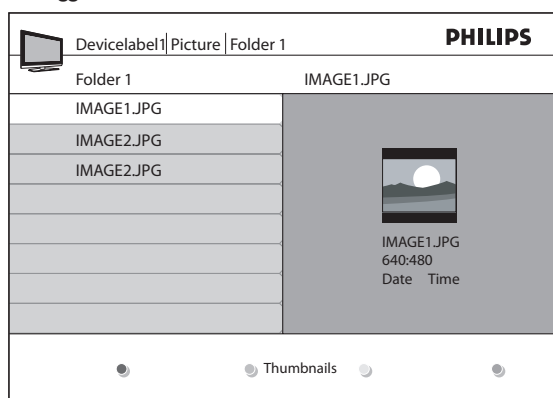

4. Press **OK** to view the picture or to start a slide show of the pictures in the album.
 - Press the color keys on the remote control to perform the function shown at the bottom of the screen.
 - If the function bar at the bottom disappears, press any color key to make it reappear.
5. Press ◀ and select another picture or another album.

You can configure the following features of the slideshow:

- **Details / More details**
Displays the picture name, date, size, and next picture in the slideshow.
- **Transitions**
Displays the list of available transition styles of the pictures.
- **Slide time**
Sets the time lag for picture transitions.
- **Rotate**
Rotates a picture.
- **Zoom**
Displays a list of available zoom magnifications.
- **Start show/Stop show**
Starts or stops a slide show.

Listen to music on a USB device

1. After connecting your USB storage device to the TV, press ► to enter the **Multimedia** menu.
2. Select **Music** then press ► to enter the **Music** folder.

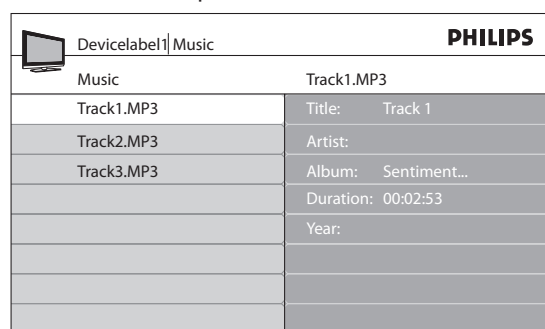

3. Press ▲ or ▼ to select a song or a music album.
 - Press the color keys on the remote control to repeat, shuffle or change the settings of the album.
 - Press **OK** to pause, press **OK** again to restart.
 - If the color keys disappear from the screen, press **OK** to make them reappear.
4. Press ◀ to select another song or album.

Accompany a slideshow with music

You can accompany a slideshow with background music. The audio continues to be played even if the slideshow is stopped. The audio stops when another song is played, or when the end of the music album is reached.

1. Select a music album as described in *Listen to music on a USB device* on this page.
2. Start a slideshow as described in *View your pictures on a USB device* on this page.

5.12 Use your TV in HDTV mode

Not all models can be configured in HDTV mode. For information about your set, see the specification.

When you connect a high definition (HD) device to your TV, you must configure the display format of your TV. You might also have to configure the display format of your HD device. For information about configuring your device, see the documentation of the device.

Supported video formats

The following video formats are supported in HDTV mode:

Resolution	Refresh rate
640 x 480p	60Hz
720 (1440) x 480i	60Hz
720 (1440) x 576i	50Hz
720 x 480p	60Hz
720 x 576p	50Hz
1280 x 720p	50Hz, 60Hz
1920 x 1080i	50Hz, 60Hz
1920 x 1080p*	24Hz, 25Hz, 30Hz, 50Hz, 60Hz

*1080p is supported in selected models only

Note

Your TV is HDMI compliant. If you do not get a good picture, change the video format on your connected devices.

Configure your TV in HDTV mode

1. Connect the HD device to your TV as described in *Connect your devices* on page 31.
2. Press **MENU** on the remote control and select **Features > Mode Selection**.

TV menu		PHILIPS
Features	Mode Selection	
Mode Selection	PC	
Caption settings	HDTV	
Sleeptimer		
Child Lock		
Change PIN		
Demo		

3. Select **HDTV** and press **◀** to confirm your choice.
4. If necessary, adjust the TV picture settings as described in *Change picture and sound settings* on page 13.
5. Press **MENU** to exit.

Note

Mode Selection item only appears for the following input signals:

- 720x480p@60 Hz
- 1280x720p@60 Hz
- 1920x1080p@24/25/30/50/60 Hz

5.13 Use your TV as a PC monitor

For information how to connect a PC to your TV see *Connect a PC* on page 33. Use an HDMI-DVI cable or an HDMI-DVI adaptor. For sound, add an audio cable with a stereo mini jack.

Caution

Before you connect your PC, set the PC monitor refresh rate to 60Hz.

Supported screen resolutions

The following screen resolutions are supported in PC mode:

Resolution	Refresh rate
640 x 480	60Hz
800 x 600	60Hz
1024 x 768	60Hz
1280 x 768	60Hz
1280 x 1024	60Hz
1360 x 768	60Hz
1920 x 1080*	60Hz

*1080p is supported in selected models only

If necessary, you can adjust the picture position to the center of the screen with the cursor buttons.

Configure your TV in PC mode

1. Connect the PC to your TV as described in *Connect a PC* on page 33.
2. Press **MENU** on the remote control and select **Features > Mode Selection**.

TV menu		PHILIPS
Features	Mode Selection	
Mode Selection	PC	
Caption settings	HDTV	
Sleeptimer		
Child Lock		
Change PIN		
Demo		

3. Select **PC** and press **OK** to confirm your choice.
4. If necessary, adjust the picture settings as described in *Change picture settings* on page 13.

Tip: Set the picture format to Unscaled when using wide-screen PC resolutions.

5. Press **MENU** to exit.

Note

Mode Selection item only appears for the following input signals:

- 720x480p@60 Hz
- 1280x720p@60 Hz
- 1920x1080p@24/25/30/50/60 Hz

5.14 Use Philips EasyLink

Your TV supports Philips EasyLink, which enables one-touch play and one-touch standby between EasyLink-compliant devices. Compliant devices must be connected to your TV via an HDMI connector.

One-touch play

When you connect your TV to devices that support one-touch play, you can control your TV and the devices with one remote control. For example, when you press **Play** on your DVD remote control, your Philips TV will automatically switch to the correct channel to show the DVD content.

One-touch standby

When you connect your TV to devices that support standby, you can use your TV remote control to put your TV and all connected HDMI devices in standby mode. You can perform one-touch standby using the remote control from any of the connected HDMI devices.

5.15 Use the demo mode

The demo mode enables you to demonstrate and learn about some of the features of your TV.

Some demos are not available on certain models. When a demo is available, you see it in the menu list.

1. Press **MENU** on the remote control and select **Features > Demo**.

TV menu		PHILIPS
Features	Demo	
Caption settings	Ambilight	
Sleeptimer	120Hz*	
Child lock	Pixel Plus	
Change PIN	HDNIM*	
Demo	Power Usage	

* Available in selected models only

2. Press **▲** or **▼** to highlight a demo, and press **OK** to start the demo.
3. Follow the on-screen instructions to enjoy the demo.
4. Press **MENU** to exit.

6. Change your TV installation

The first time you switch on your TV you select the language for the TV menus and make basic choices for picture and sound settings. Use this chapter to reinstall the TV, to set preferences in the TV menus, or to tune new TV channels.

6.1 Select your menu language

1. Press **MENU** on the remote control and select **Installation > Language**.

TV menu		PHILIPS
Installation	Language	
Language	<input type="radio"/>	English
Channels	<input type="radio"/>	Français
Preferences	<input type="radio"/>	Espanol
Source labels		
Clock		
Current software info		
Reset AV settings		

2. Select a language and press **OK** to confirm your choice.
3. Press **◀** to return to the **Installation** menu.

6.2 Set your location to home

You can set the location of your TV to **Home** or **Retail store**. Choosing **Home** gives you full flexibility to change predefined settings for picture and sound.

1. Press **MENU** on the remote control and select **Installation > Preferences > Location**.
2. Select **Home** and press **OK** to confirm your choice.
3. Press **◀** to return to the **Installation** menu.

6.3 Tune channels automatically

This section describes how to search for and store channels automatically. Before you tune channels, ensure that you are registered with your cable TV provider and that your equipment is correctly connected.

1. Press **MENU** on the remote control and select **Installation > Channels > Autoprogram > Start Now**.

TV menu Installation		PHILIPS
Channels	Autoprogram	
Autoprogram		
Weak channel installation	<input type="radio"/>	Start Now
Installation mode		
Uninstall channels		

2. Press **OK** to start the installation.
If you run **Autoprogram** when you have locked channels, a message appears asking to enter your PIN code. Enter your PIN code in order to complete the installation.

If you have forgotten your PIN, reset it as described in *Set or change your PIN* on page 18.

3. Select **Cable** or **Antenna** and press **OK**.

- When **Antenna** is selected, the TV detects antenna signals. It searches for NTSC and ATSC channels available in your area.
- When **Cable** is selected, the TV detects signals supplied by cable. It searches for NTSC, ATSC, and QAM modulated channels available in your area.

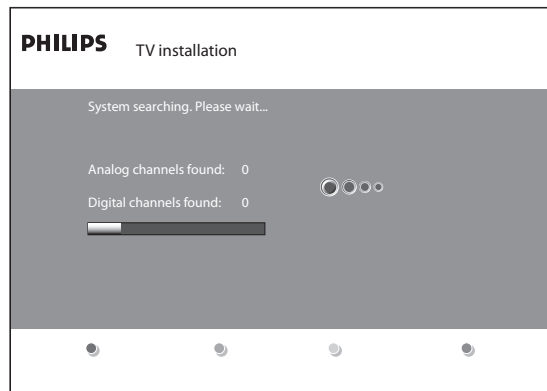

When autoprogramming is complete, this message appears "**Channel search completed**".

4. Follow the on-screen instructions to complete the installation.

6.4 Optimize the signal quality from your antenna

You can optimize your signal quality by tuning in ATSC channels with weak signals, and adjusting the antenna.

1. Press **MENU** on the remote control and select **Installation > Channels > Installation mode**.
2. Select **Antenna** and press **◀** to confirm your choice.
3. Press **▲** and **▶** to enter **Weak channel installation**.
4. Highlight a channel from the list of TV channels and press the green color button on the remote control. The signal strength for the channel is displayed.
5. Adjust your antenna to maximize the signal strength.
6. Press **MENU** to exit.

6.5 Uninstall and reinstall channels

This section describes how to uninstall and reinstall a stored channel. When a channel is uninstalled it is removed from the list of channels.

Uninstalled channels are not reinstalled during an installation update.

1. Press **MENU** on the remote control and select **Installation > Channels > Uninstall channels**.

TV menu Installation		PHILIPS	
Channels		Uninstall channels	
Autoprogram	<input type="checkbox"/>	52	
Weak channel installation	<input type="checkbox"/>	53	
Installation mode	<input checked="" type="checkbox"/>	54	
Uninstall channels	<input type="checkbox"/>	55	
	<input type="checkbox"/>	56	
	<input type="checkbox"/>	57	
	<input type="checkbox"/>	58	
	<input type="checkbox"/>	59	

2. Press **▶** to enter the list of stored channels.
3. Press **▲** or **▼** to select the channel you want to uninstall, and press the green key on the remote control.

The channel is removed from the channel list. Press the green key again to reinstall the channel.

4. Press **MENU** to exit.

6.6 Return your settings to default values

This section describes how to return picture and sound settings to their default values. The channel installation settings are not affected.

1. Press **MENU** on the remote control and select **Installation > Reset AV settings**.

TV menu		PHILIPS	
Installation		Reset AV settings	
Language			
Channels			
Preferences			
Source labels			
Clock			
Current software info			
Reset AV settings			

2. Press **▶** to highlight **Start now**, and press **OK** to reset the AV settings.
3. Press **Menu** to exit.

6.7 Show emergency alerts (EAS)

The SCTE18 standard defines an emergency alert signalling method for use by cable TV systems. EAS can be broadcast to digital devices such as digital set-top boxes, digital TVs, and digital VCRs.

The EAS scheme allows a cable operator to disseminate information related to state and local emergencies and warnings.

EAS contain the following information:

- Emergency alert text
- Start time and date
- End time and date
- Priority

EAS with priority **Maximum** or **High** are always displayed on your TV. However, you can configure your TV to not show EAS messages with **Medium** or **Low** priority.

EAS is not possible with a multimedia browser or with analog video sources.

You can always remove the message from the screen. The message display overlaps menus and other messages on the screen.

Configure emergency alerts

1. Press **MENU** on the remote control and select **Installation > Preferences > Show emergency alerts**.

TV menu Installation		PHILIPS	
Preferences		Show emergency alerts	
Location		Always	
Show emergency alerts		Skip low priority	
Downloaded rating table		Skip medium/low priority	

2. Highlight one of the following options:
 - **Always**
To display all emergency alert messages
 - **Skip low priority**
To show all messages except low priority messages
 - **Skip medium/low priority**
To show maximum and high priority messages only
3. Press **◀** to confirm your choice.
4. Press **MENU** to exit.

7. Update your TV software

Philips continuously tries to improve its products and we strongly recommend that you update the TV software when updates are available.

New software can be obtained from your dealer or downloaded from the www.philips.com/welcome website. Use the type number of your TV (e.g. 42PFL5603D/27) to find information.

For information about using a USB device, see *Notes for the use of USB devices* on page 36.

7.1 Check your current software version

1. Press **MENU** on the remote control and select **Installation > Current software info**.

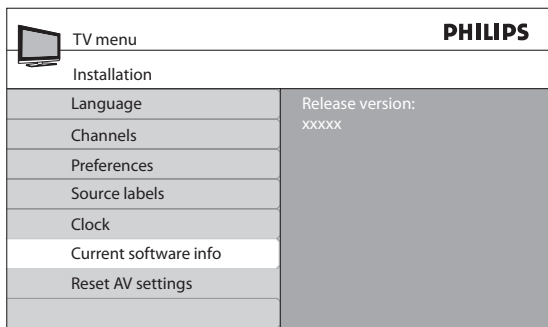

The version and a description of the current software is displayed.

7.2 Prepare for the software upgrade

You require the following equipment:

- A PC with web browsing capability.
- An archive utility that supports the ZIP-format (e.g. WinZip for Windows or Stuffit for Mac OS).
- A USB memory stick.

Note:

- Only FAT/DOS-formatted portable memory is supported.
- New software can be obtained from your dealer or can be downloaded from the www.philips.com/welcome website.
- Use only software upgrades that can be found on the Philips web site.

Warning:

- Do not remove the USB device during the software upgrade.
- If there is a power drop during the upgrade, do not remove the USB device from the TV. The TV will continue the upgrade as soon as the power comes back.
- If you try to upgrade to a software version lower than the current version, a confirmation message will be displayed. Downgrading to older software should be done only in case of real necessity.
- If an error occurs during the upgrade, retry the procedure or contact your dealer.

Download the software

1. On your PC, open a web browser and go to www.philips.com/welcome.
2. Find information and software related to your TV and download the latest software upgrade file to your PC.
3. Decompress the ZIP-file and copy the “**autorun.upg**” file to the root directory of your the USB device.

7.3 Upgrade software

1. Prepare the software upgrade as described above.
2. Connect your USB device to the USB port on the side of your TV. The TV scans the USB device for the updated software and automatically enters the upgrade mode.
3. Read the instructions on-screen and confirm that you want to continue with the installation.

You see a screen similar to this.

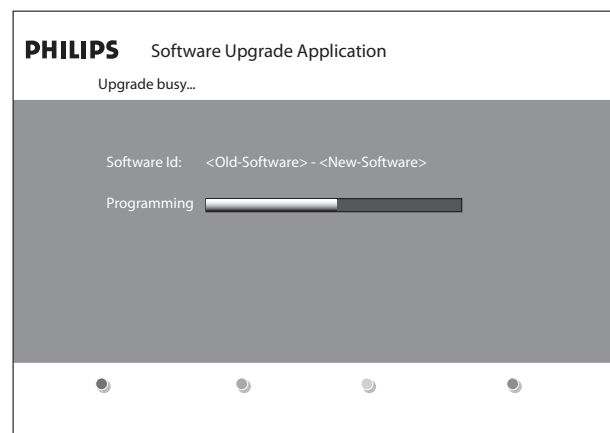

4. When the software upgrade is complete, remove the USB device.
5. Disconnect the TV from the power socket outlet.
6. Reconnect the TV to the power socket outlet.
7. Press **Power** at the side of the TV to switch the TV on. The TV starts up with the new software.

8. Connect devices

8.1 Connection overview

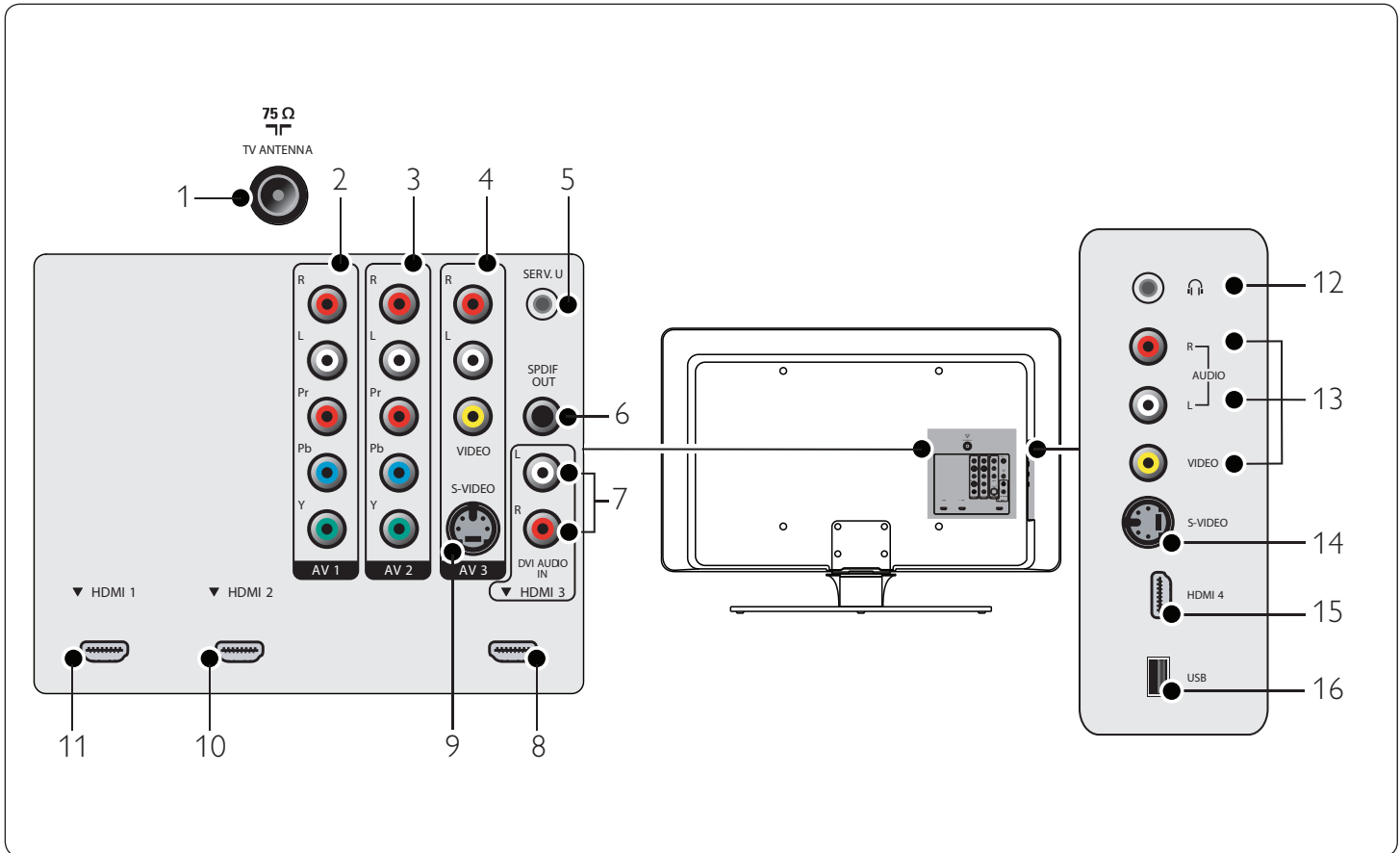

1. Antenna input

2. AV1

Component video input. Y Pb Pr and Audio L/R connectors for DVD, digital receiver or game console, etc.

3. AV2

Second component video input.

4. AV3

Composite video input to be used together with Audio L/R connectors for camcorder, game console, etc.

5. Service UART

For use only by authorized service personnel.

6. SPDIF Out

Digital audio out.

7. DVI Audio IN for HDMI 3.

8. HDMI 3 In

HDMI in connector for Blu-ray Disc player, HD digital receiver or HD game console, etc.

9. S-Video (AV3)

S-Video input connector to be used together with Audio L/R connectors for camcorder, game console, etc.

Note: When you use the S-Video (AV3) for video signals, do not use the composite video input on AV3 for video signals.

10. HDMI 2 In

Second HDMI in connector.

11. HDMI 1 In

First HDMI in connector.

12. Headphones

Stereo Mini Jack.

13. Video (Side)

Video input cinch connector to be used together with Audio L/R connectors for camcorder, game console, etc.

14. S-Video (Side)

S-Video input connector to be used together with Audio L/R connectors for camcorder, game console, etc.

Note: When you use the S-Video (side) for video signals, do not use the video (side) input for video signals.

15. HDMI 4 In (Side)

HDMI in connector for Blu-ray Disc player, HD digital receiver or HD game console, etc.

16. USB

USB connector.

8.2 Select your connection quality

This section describes how you can enhance your audio visual experience by connecting your devices with the best possible connectors.

HDMI - Highest quality

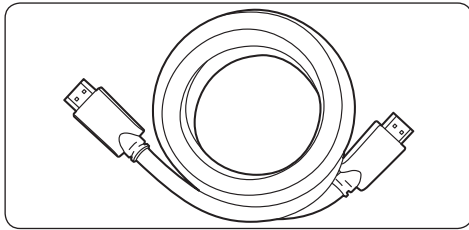

HDMI produces the best audio visual quality possible. Both audio and video signals are combined in one HDMI cable, providing an uncompressed, digital interface between your TV and HDMI devices. You must use HDMI to experience full high definition video. You must also use HDMI cables to use Philips EasyLink as described in *Use Philips EasyLink* on page 25.

Use only a certified HDMI cable.

Tip

If your device only has a DVI connector, use a DVI-HDMI adaptor to connect your device to a HDMI connector on the TV. As such a connection does not support sound, you must connect a separate audio cable from the device to the Audio L/R input connectors on the TV.

Note

Philips HDMI supports High-bandwidth Digital Contents Protection (HDCP). HDCP is a form of Digital Rights Management that protects high definition content in DVD or Blu-ray discs.

Component (YPbPr) - High quality

Component (Y Pb Pr) video provides better picture quality than S-Video or composite video connections. Though component video supports high definition signals, picture quality is lower than HDMI and is analog.

When connecting a component video cable, match the cable colors to the connectors on the back of the TV. Also, connect an Audio L/R cable to the red and white Audio L/R input connectors.

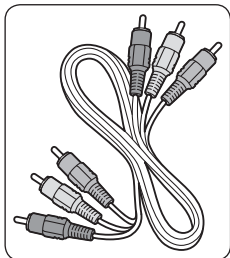

Component video cable
- Red, Green, Blue

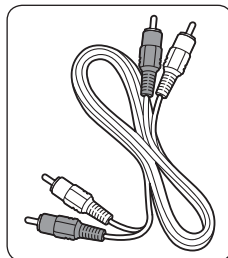

Audio L/R cable
- Red, White

S-Video - Good quality

An analog connection, S-Video provides better picture quality than composite video. When connecting your device with S-Video, plug the S-Video cable to the S-Video connector on the side of the TV. You must connect a separate Audio L/R cable from the device to the red and white Audio L/R in/out connectors on the side of the TV.

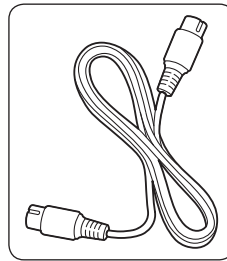

S-Video cable

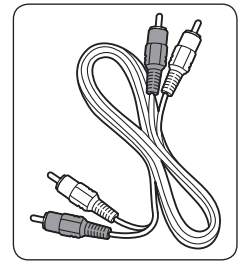

Audio L/R cable
- Red, White

Composite - Basic quality

Composite video provides basic analog connectivity, usually combining a (yellow) video cinch cable with (red and white) Audio L/R cinch cable. Match the cable colors when connecting to the composite video and audio L/R input connectors on the side of the TV.

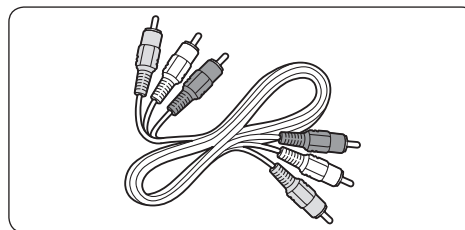

Composite audio/video cable
- Yellow, red and white

8.3 Label your connections

When you connect devices, you can label the connections to help you to later identify where devices are connected.

1. Press **MENU** on the remote control and select **Installation > Source Labels**.

TV menu		PHILIPS
Installation		Source labels
Language		AV1
Channels		AV2
Preferences		AV3
Source labels		HDMI1
Clock		HDMI2
Reset AV settings		HDMI3
Software upgrade		Side HDMI
		Side AV

2. Press **▶** to enter the list of available connections.
3. Press **▲** or **▼** to highlight a connection in the list.
4. Press **▶** to enter the list of devices for the connection, and press **▲** or **▼** to highlight a device.
5. Press **◀** to confirm your choice.
6. Press **MENU** to exit.

8.4 Connect your devices

This section describes how to connect a selection of devices with different connectors. Note that different types of connectors may be used to connect a device to your TV. The following sections describe examples only, other configurations are possible.

When connecting composite or component cables, match the cable colors to the connectors on the TV.

Connect a set-top box and a DVD player/recorder via composite connectors

⚠ Warning

Do not place your recorder too close to the screen because some recorders can be susceptible to signals.

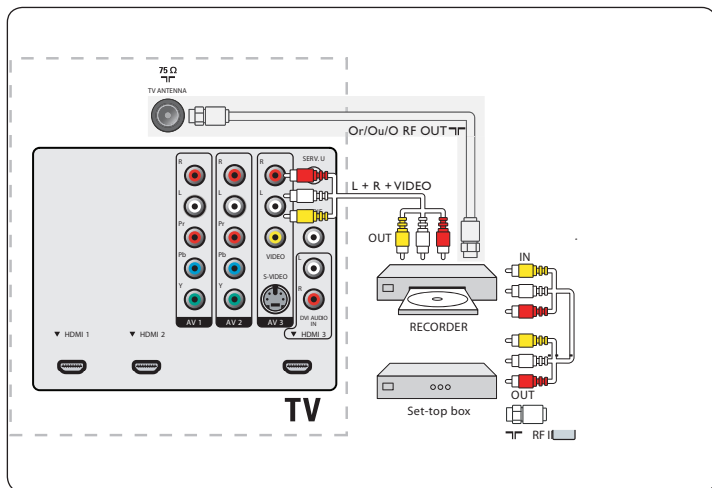

Connect a DVD recorder or VCR and a second A/V device via composite connectors

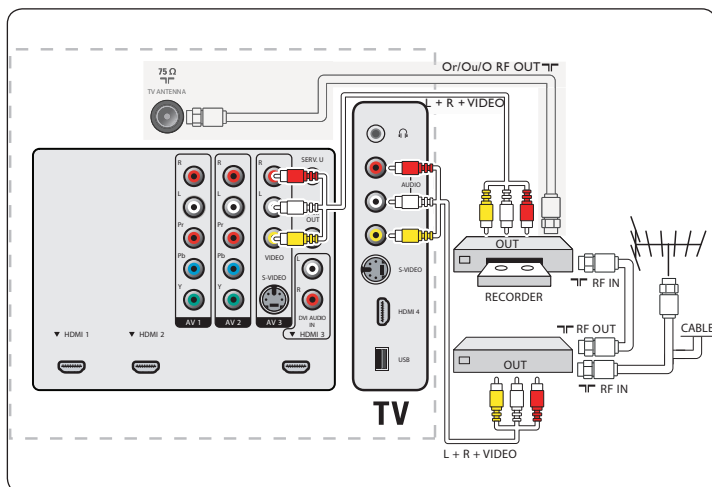

If your recorder has an S-VHS video jack: for improved picture quality, connect an S-Video cable with the S-Video input and connect the audio cables to the audio L and R input jacks of AV3/side AV.

ⓘ Note

When you use an S-Video connector, do not connect any device to the AV3/side AV video jack.

If you use mono equipment, the left loudspeaker reproduces sound but the right speaker does not. Use a mono to stereo adapter (not supplied) for sound reproduction via all internal loudspeakers.

Connect a set-top box, DVD player/recorder and game console via HDMI

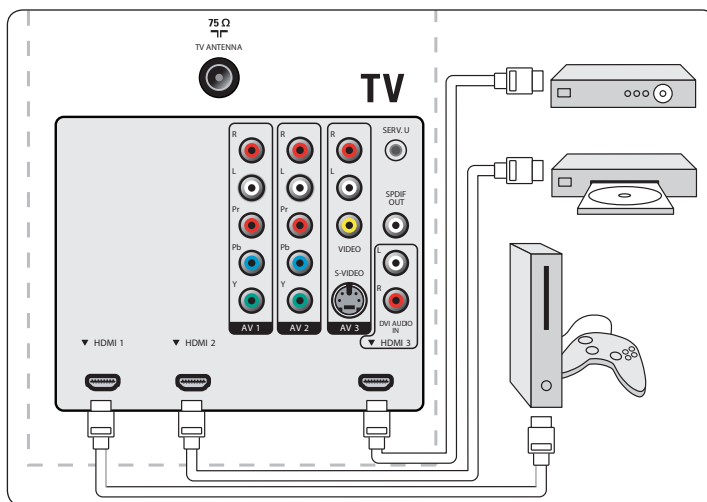

Connect a DVD player/recorder via HDMI-DVI and DIGITAL AUDIO OUT connectors

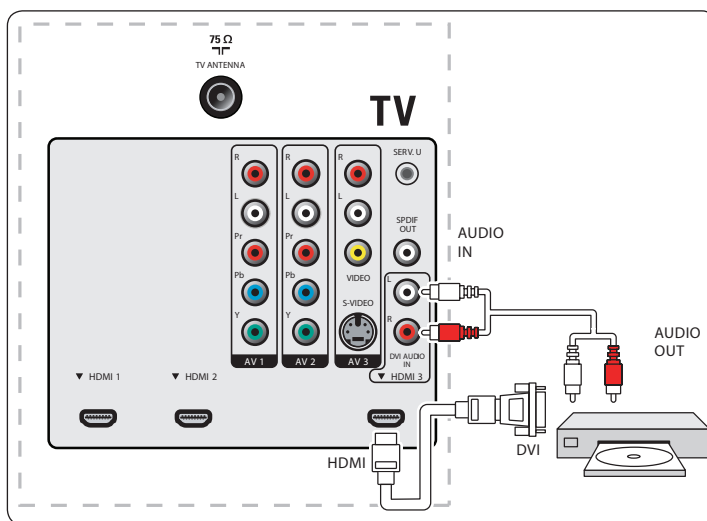

Connect a DVD player via S-Video and audio connectors

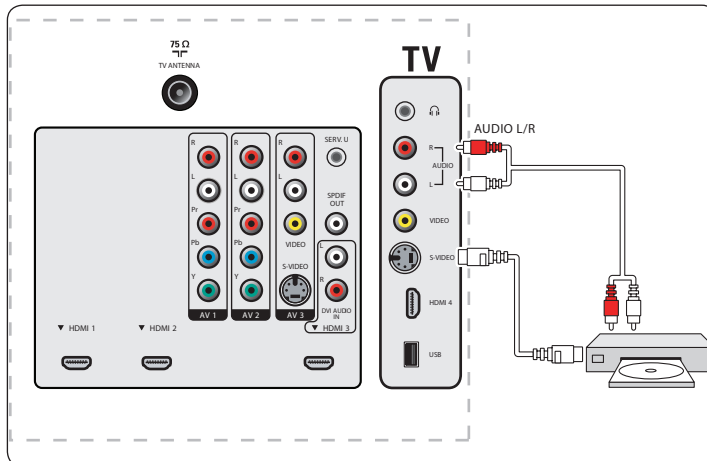

⚠ Warning

When using the S-Video (AV3) connector, do not connect any device to the AV3 composite video input.

Connect a set-top box via a composite connector

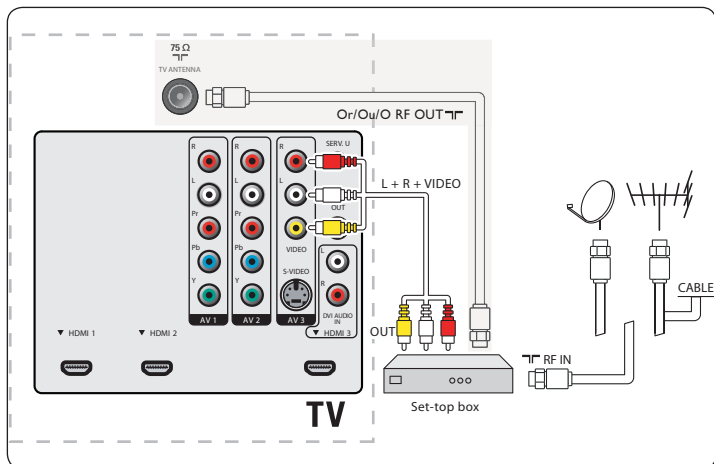

If your device has an S-VHS video jack: For improved picture quality, connect a S-Video cable with the S-Video input of AV3/side AV and connect the audio cables to the audio L and R input jacks of AV3/side AV.

Warning

When using the S-Video connector do not connect any device to the video jack of AV3 or the side AV.

Only the left loudspeaker reproduces sound for mono equipment. Use a mono to stereo adapter (not supplied) for sound reproduction via all internal loudspeakers.

Connect a DVD player/recorder via component video output connectors (YPbPr) and analog audio

Selected TV models are capable of displaying 1080i, 1080p, 720p and 480p DTV signals when connected to a DTV tuner cable box. Select the output of the cable box to either 1080i, 1080p, 720p or 480p. A DTV signal must be available in your area.

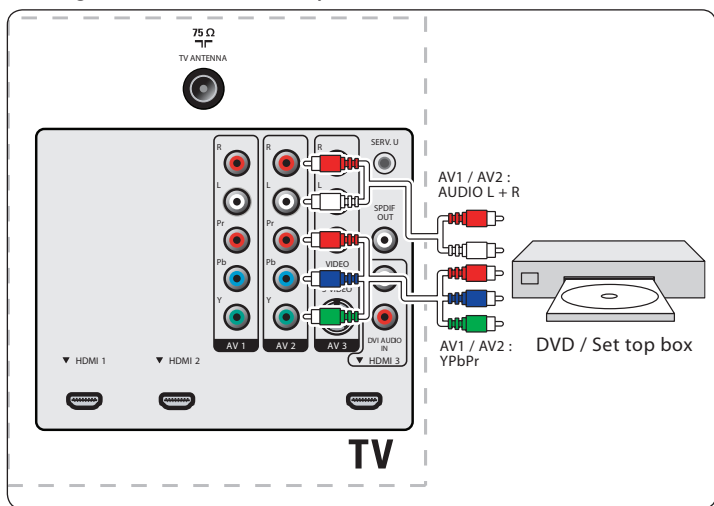

Connect a digital home theater amplifier

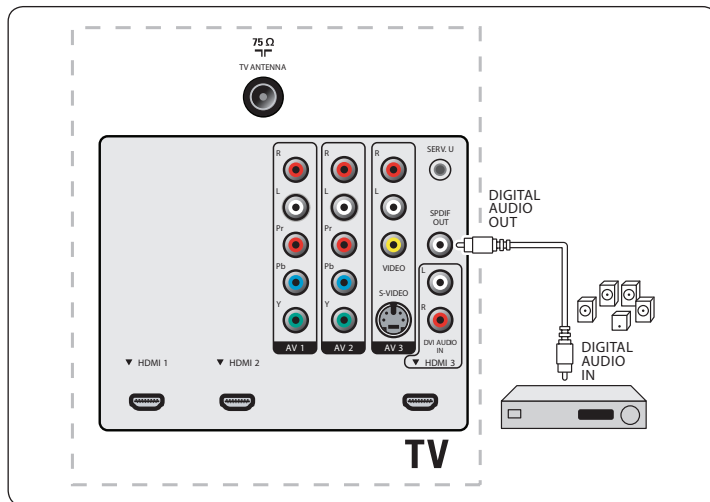

Warning

Due to legal requirements, it is possible that with certain copy protected PCM audio qualities from a accessory device connected to the HDMI input, the digital audio signal is muted.

Connect a PC

Connect a PC with an S-Video connector at the back

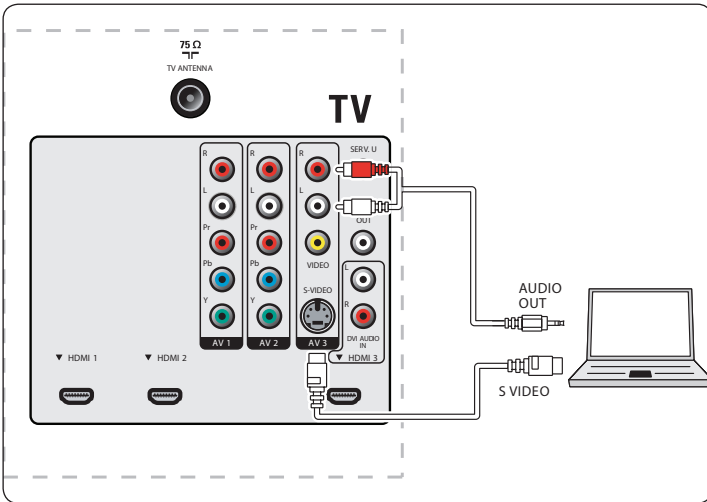

Connect a PC with an HDMI connector

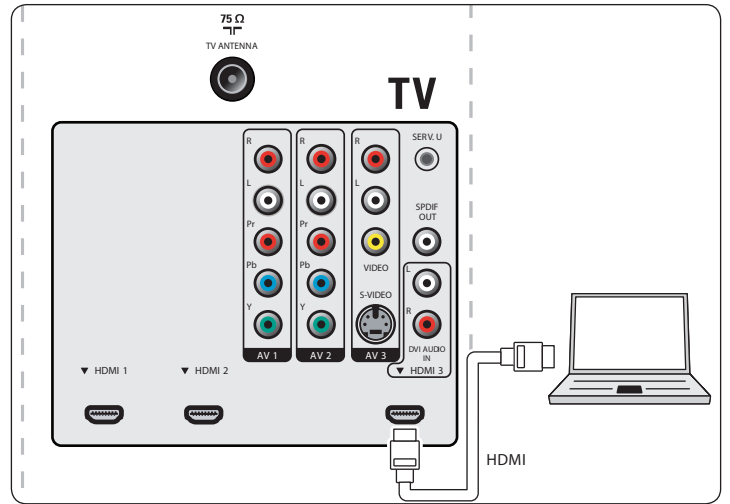

Connect a PC with an S-Video connector at the side

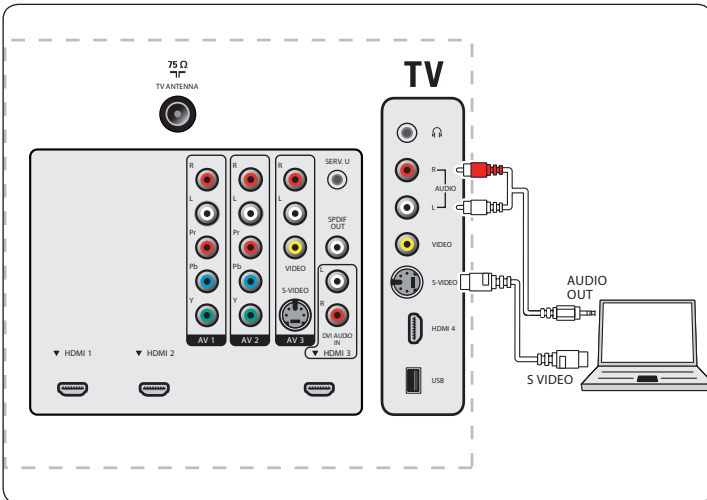

Connect a PC with a DVI connector

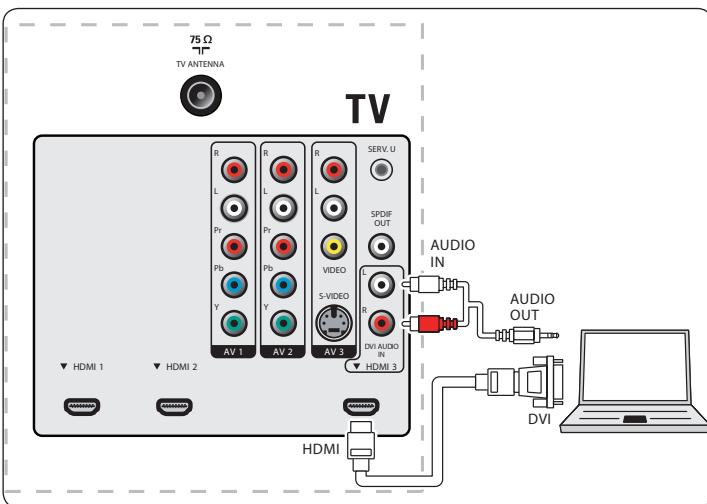

9. Glossary

Term		Meaning
DVI	Digital Visual Interface	A digital interface standard created by the Digital Display Working Group (DDWG) to convert analog signals into digital signals to accommodate both analog and digital monitors.
RGB signals	Red, Green and Blue signals	These are the three video signals, red, green & blue, which make up the picture. Using these signals improves picture quality.
S-VHS signals	Super-VHS signals	These are 2 separate Y/C video signals from the S-VHS and Hi-8 recording standards. The luminance signals Y (black and white) and chrominance signals C (color) are recorded separately on the tape. This provides better picture quality than with standard video (VHS and 8 mm) where the Y/C signals are combined to provide only one video signal.
16:9	TV format	Refers to the ratio between the length and height of the screen. Wide screen televisions have a ratio of 16 by 9, conventional screen TV sets have a ratio of 4 by 3.
HDMI	High definition Multimedia Interface	Provides an uncompressed, all digital audio/video interface between the TV and any HDMI-equipped audio/video component, such as set-top box, DVD player and A/V receiver. HDMI supports enhanced or high definition video plus two-channel digital audio.
System		Television pictures are not broadcast in the same way in all countries. There are different standards: BG, DK, I, and LL'. The System setting is used to select these different standards. This is not to be confused with PAL or SECAM color coding. PAL is used in most countries in Europe, Secam in France, Russia and most African countries. The United States and Japan use a different system called NTSC. The inputs AV1 and AV2 are used to read NTSC coded recordings.
HDCP	High-bandwidth Digital Content Protection	A specification developed by Intel for protecting digital entertainment that uses the DVI interface. HDCP encrypts content the transmission of digital content between the video source or transmitter such as a computer, DVD player or set-top box and the digital display or receiver such as a monitor, television or projector.
BBE	Barcus Berry Electronics	A sound enhancement technology.
EasyLink	Philips EasyLink	Enables one-touch play and one-touch standby with EasyLink compliant devices that are connected to your TV by HDMI.

10. Troubleshooting

Symptoms	Possible cause	What should you do
No power or indicator light.	The TV is not connected to the power.	1. Press POWER at the right side of the TV, or press POWER on the remote control.
		2. Ensure the power cord is connected tightly to the TV power connector and to the power socket outlet.
		3. Remove the power cord from the power socket outlet, wait 60 seconds and reconnect the power cord.
		4. Connect the TV to a different power socket outlet.
Error message on the screen with HDMI connection.	HDCP authentication fail.	1. Ensure that your HDMI cable is certified.
		2. Press SOURCE on the remote control to switch to another source and then switch back to the HDMI source.
		3. Reset the accessory device and the TV. <ul style="list-style-type: none"> • Turn on the TV • Select the HDMI channel • Turn on the accessory device
		4. While the TV and the accessory device are powered on, unplug either end of the HDMI cable and then reinsert the cable.
No sound is detected from the PC.	Incorrect HDMI port is connected.	1. Connect a DVI-HDMI cable to the HDMI 3 port on the TV.
	Audio cable is not connected.	2. Connect an audio cable to the DVI AUDIO IN port on the TV.
		3. Press SOURCE on the remote control, and select the HDMI 3 source.
TV does not respond to the remote control.	Batteries are installed incorrectly, or low battery power.	1. Ensure the indicator light on the TV blinks when the remote control buttons are pressed.
		2. Ensure that you are using the remote control supplied with the TV.
		3. Ensure that the batteries of the remote control are inserted according to the illustration on the remote control and that the batteries do not need to be replaced.
		4. Remove the power cord from the power socket outlet, wait 60 seconds and reconnect the power cord.
The picture is distorted. It is stretched out, has short, fat, black bars on the side or top.	Broadcast video format.	1. Press the FORMAT button on the remote control to select the best picture format.
		2. For some accessory devices, the picture format has to be set in the accessory device.
The picture is mostly red and green, or the picture is missing red when the TV is connected to an accessory device via component cables.	Insecure/incorrect connection.	1. Ensure all the connections are made according to the color code. 2. Push the component cables all the way into the YPbPr sockets on the TV.
No sound on the TV loudspeaker.	Volume level is set to zero.	1. Increase the volume.
	Sound is muted.	2. Press MUTE on the remote control.
	Headphones are connected.	3. Ensure the headphones are not plugged into the TV.
	Audio cable is not connected.	4. For AV connection, ensure that the Audio L/R cable is connected as described in <i>Connect your devices</i> on page 31. If you are using a component cable, ensure that you have not crossed the red audio cable with the red video cable.
	Accessory device audio output setting is incorrect.	5. For HDMI connections, some accessory devices have an HDMI audio output setting that must be turned on for HDMI to HDMI connections.
Bad picture quality with a coaxial connection.	Standard definition channels are not as clear as high definition channels.	1. Connect the devices via component or HDMI cables.
No picture or sound.	Incorrect channel	1. Ensure you have selected the correct channel.
	Incomplete channel installation.	1. If the TV receives channels via an AV connection, set the TV to the correct source input.
		2. If the TV is connected directly to the wall via a coaxial connection, perform the auto-installation again.
Cannot control your TV and connected devices with one remote control.		1. Confirm that the connected devices are EasyLink compliant and are connected to your TV via an HDMI cable. Not all brands of devices such as DVD players use the same system as Philips EasyLink. Other brands might not work with Philips EasyLink.

11. Notes for the use of USB devices

Digital Content Issues

- Only FAT (DOS) formatted (initialized) portable memory is supported. Errors in this formatting can result in unreadable content. If such problems appear try to re-format the card. Be aware that formatting the card will also delete all the content on it (pictures, music, ...).
- The following file types are supported: .jpg, .jpeg, .mp3, .alb, .m3u and .pls.
- Only linear JPEG picture formats are supported. Progressive JPEG and JPEG2000 encodings are not supported.
- The length of a filename or directory name is limited to the length specified by the FAT16/32 file systems.
- Max. levels of nested directories is 19.
- Never use the supported file type extensions (.jpg, .jpeg, .mp3, .alb, .m3u and .pls) as extensions for directories as these directories will be treated as corrupted files.
- The MP3 decoder does not support MPEG1 Layer 1 or Layer 2 playback.
- MP3 Pro files can be played with normal MP3 quality.
- The access and response time of the content on a device can differ depending on the type or brand of the device.
- The access and response time of the content on a device will increase the more unsupported or corrupted files are on the device.

Digital Camera Issues

- If a USB connection between your digital camera and the TV isn't working, you can try the solutions below to resolve your problem.
- Make sure your digital camera is switched on and verify if the configuration of your digital camera is correct (see the manual of your digital camera for more information).
- Some digital cameras allow you to switch off the USB interface. Make sure that the USB interface is switched on before connecting to the TV.
- If you have a digital camera with only internal memory (no removable memory) you can try to copy the content manually to a USB memory device (e.g. Philips KEY product) using a personal computer.
- Some digital cameras allow you to switch between PTP (Picture Transfer Protocol) or "PC Link" and USB Mass Storage or "PC Drive". Make sure that you select USB Mass Storage or "PC Drive" on your digital camera.
- If your camera supports different interface settings be sure to try them one by one or contact the reseller of your camera to find out the correct setting.

USB Memory Device Issues

- Devices connected to the USB port of your TV must be "Mass Storage Class" compliant. If your device (digital camera, MP3 player, portable hard disk, ...) is not "Mass Storage Class" compliant it will not be detected by the content browser of the TV.

- The following subsets of the Mass Storage Class specification are supported:
 - The implementation of the TV is based on the "Universal Serial Bus Mass Storage Class Specification Overview" (v1.2, June 23, 2003) including all documents referenced by the document. The document can be found on the USB standardization website (www.usb.org).
 - Full support of the USB Mass Storage Class Bulk-Only Transport (bInterfaceProtocol = 50h).
 - Full support of SubClass Code = 05h; SFF-8070i spec.
 - Full support of SubClass Code = 06h; SCSI transparent command set.
- For large USB memory devices, when you are in the Content Browser, it may take a long time before you can access your files.
- When using a USB portable hard disk: Due to the high power consumption of the hard disk, it is advised to use the external power supply of the portable hard disk to guarantee proper working under all conditions.

12. Technical specifications

Feature	Description
Type no.	42-57PFL7603D
PICTURE ENHANCEMENT	
Type	1080p 120Hz
Brightness	500 cd/m2
Aspect Ratio	16:9
Response Time	2ms
Viewing Angles	178 (V) by 178 (H)
Built-in digital tuner	ATSC/QAM
HD Natural Motion	Yes
Dynamic Dimming BL	Yes
Ambient Light Sensor	Yes
Ambilight	Yes
SOUND ENHANCEMENT	
Mono/Stereo/BBE	
Power output (RMS Watts)	30 W
Equalizer	5 band
EASE OF USE	
Video modes	Automatic, 4:3, Movie Expand 14:9, Movie Expand 16:9, Super Zoom, Wide Screen, Unscaled
PC input	via HDMI
Photo Slide Show	Yes (jpeg files only)
MP3 Playback	Yes (mp3 files only)
CONNECTIONS	
Component video input with Audio L/R	2, supporting 480i/p, 576i/p, 720p, 1080i, 1080p @24Hz-60Hz
Composite video input with audio L/R and S-Video	2
HDMI	4, ver1.3a HDMI supporting video: 480i/p, 576i/p, 720p, 1080i, 1080p @24Hz-60Hz, PC-input: up to WUXGA
Digital audio out	Yes, supporting AC-3 & PCM
Headphone	1 (on the side of TV)
USB	1 (on the side of TV)
MISCELLANEOUS	
Auto multi-voltage	110V-240V~/50-60 Hz, 120V
Table Top Stand Swivel	Yes

13. Index

A

- Active control 14
- Ambilight
 - Adjust settings 15
 - Change mode 15
 - Color 15
 - Modes 15
- Antenna, connect 7
- Audio 15
 - Alternate 15
 - Language 15
- Auto format 14
- Automatic
 - Channel installation 26
 - Surround 15
 - Volume leveling 15
- Auto Mode 16

B

- Back connectors 6
- Balance, Ambilight 15
- Batteries 7
- Blu-ray 29
- Brightness
 - Ambilight 15
 - Picture 14

C

- Cable
 - Component 30
 - Composite 30
 - HDMI 30
 - Management 8
 - Quality comparison 30
 - S-Video 30
 - YPbPr 30
- CA module 29
- Care
 - Environment 5
 - Screen 5

Channels

- Favorite list 16
- Install 26

Child lock

- Lock all channels/devices 18
- Lock one or more channel/device 18
- PIN code 18
- Set movie rating 19
- Set TV rating 19

Clock 17

Closed captions 21

Color

- Enhancement 14
- Picture setting 14
- Temperature 14

Component cable 30

Composite cable 30

Configuring the TV in HDTV mode 24

Connection

- Antenna 7
- Back connectors 6
- Cable quality 30
- DBS 7
- Devices 31
- Label 30
- Overview 29
- PC 33
- Power cord 8
- Set-top box 8
- Side connectors 6

Contrast 14

Controls 6

Customer support service 5

D

- DBS, connect 7
- Default, return to 27
- Delta volume 15
- Demo mode 25

- Device, connect 31
- Disconnect power 8
- Display, native 1080 24
 - Supported formats 25
- Dynamic contrast 14

E

- EAS 27
- Emergency alerts 27
- Environmental care 5
- Equalizer 15

F

- Favorite lists 16

H

- HDCP 30
- HDMI cable 30
- HDTV mode 24
- Home mode 26
- Horizontal shift 14

I

- Installation
 - Channels 26
 - First time 9

L

- Label connections 30
- Language
 - Audio 15
 - Menus 26
- Location 26
- Locks. See Child lock

M

- Menu
 - Language 26
 - Quick access 13

Mode

- HD 24
- Home or retail store 26
- PC 24

Model number 5**Movie expand 14****Movie ratings 20****MPEG artefact reduction 14****Multimedia 22****Music. See Photos and music**

N

- Noise reduction 14

O

- One-touch play 25
- Overview, TV 6

P**Parental control. See Child lock****PC mode 24****Photos and music 22**

- Connect USB device 22
- Listen to music 23
- View photos 23
- View slide show with music 23

Picture

- Adjust settings 13
- Auto modes 16
- Change format 14

PIN code 18**Power cord**

- Connect 8
- Disconnect 8

Product information 5

Q

- Quick access menu 13

R**Ratings**

- Movie 20
- Region 21
- TV 19

Recycling 5**Region ratings 21****Register your TV 5****Remote control**

- Advanced use 12
- Basic use 6
- Batteries 7

Retail store mode 26

S**Screen care 5****Screen resolution, PC mode 24****Settings 15****Settings assistant 13****Set-top box, connection 8****Sharpness 14****Shift**

- Horizontal 14
- Vertical 14

Side controls and connectors 6**Signal quality 26****Sleeptimer 17****Software**

- Update 28
- Version 28

Sound

- Auto modes 16
- Surround mode 15

Specifications 37**Store mode 26****Super zoom 14****S-Video cable 30****Clock 17****Sleeptimer 17****Tint 14****TV**

- Model number 5
- Overview 6
- Position 7
- Ratings 19

U**Upgrade software 28****USB 22**

- Connector 29
- Notes on use 36

V**Version, software 28****Vertical shift 14****Video cable 30****Video format, HD mode 24**

Y**YPbPr cable 30**

T**Technical specifications 37****Timer**

14. Warranty

PHILIPS LIMITED WARRANTY ONE (1) YEAR

WARRANTY COVERAGE:

PHILIPS warranty obligation is limited to the terms set forth below.

WHO IS COVERED:

Philips warrants the product to the original purchaser or the person receiving the product as a gift against defects in materials and workmanship as based on the date of original purchase ("Warranty Period") from an Authorized Dealer. The original sales receipt showing the product name and the purchase date from an authorized retailer is considered such proof.

WHAT IS COVERED:

The Philips warranty covers new products if a defect in material or workmanship occurs and a valid claim is received by Philips within the Warranty Period. At its option, Philips will either (1) repair the product at no charge, using new or refurbished replacement parts, or (2) exchange the product with a product that is new or which has been manufactured from new, or serviceable used parts and is at least functionally equivalent or most comparable to the original product in Philips current inventory, or (3) refund the original purchase price of the product. Philips warrants replacement products or parts provided under this warranty against defects in materials and workmanship from the date of the replacement or repair for ninety (90) days or for the remaining portion of the original product's warranty, whichever provides longer coverage for you. When a product or part is exchanged, any replacement item becomes your property and the replaced item becomes Philips' property. When a refund is given, your product becomes Philips' property.

Note: Any product sold and identified as refurbished or renewed carries a ninety (90) day limited warranty.

Replacement product can only be sent if all warranty requirements are met. Failure to follow all requirements can result in delay.

WHAT IS NOT COVERED - EXCLUSIONS AND LIMITATIONS:

This Limited Warranty applies only to the new products manufactured by or for Philips that can be identified by the trademark, trade name, or logo affixed to it. This Limited Warranty does not apply to any non-Philips hardware product or any software, even if packaged or sold with the product. Non-Philips manufacturers, suppliers, or publishers may provide a separate warranty for their own products packaged with the bundled product.

Philips is not liable for any damage to or loss of any programs, data, or other information stored on any media contained within the product, or any non-Philips product or part not covered by this warranty. Recovery or reinstallation of programs, data or other information is not covered under this Limited Warranty.

This warranty does not apply (a) to damage caused by accident, abuse, misuse, neglect, misapplication, or non-Philips product, (b) to damage caused by service performed by anyone other than Philips or Philips Authorized Service Location, (c) to a product or a part that has been modified without the written permission of

Philips, or (d) if any Philips serial number has been removed or defaced, or (e) product, accessories or consumables sold "AS IS" without warranty of any kind by including refurbished Philips product sold "AS IS" by some retailers.

This Limited Warranty does not cover:

- Shipping charges to return defective product to Philips.
- Labor charges for installation or setup of the product, adjustment of customer controls on the product, and installation or repair of antenna/signal source systems outside of the product.
- Product repair and/or part replacement because of improper installation or maintenance, connections to improper voltage supply, power line surge, lightning damage, retained images or screen markings resulting from viewing fixed stationary content for extended periods, product cosmetic appearance items due to normal wear and tear, unauthorized repair or other cause not within the control of Philips.
- Damage or claims for products not being available for use, or for lost data or lost software.
- Damage from mishandled shipments or transit accidents when returning product to Philips.
- A product that requires modification or adaptation to enable it to operate in any country other than the country for which it was designed, manufactured, approved and/or authorized, or repair of products damaged by these modifications.
- A product used for commercial or institutional purposes (including but not limited to rental purposes).
- Product lost in shipment and no signature verification receipt can be provided.
- Failure to operate per Owner's Manual.

TO OBTAIN ASSISTANCE IN THE U.S.A., PUERTO RICO, OR U.S. VIRGIN ISLANDS...

Contact Philips Customer Care Center at:
1-888-PHILIPS (1-888-744-5477)

TO OBTAIN ASSISTANCE IN CANADA...

1-800-661-6162 (French Speaking)
1-888-PHILIPS (1-888-744-5477) - (English or Spanish Speaking)

REPAIR OR REPLACEMENT AS PROVIDED UNDER THIS WARRANTY IS THE EXCLUSIVE REMEDY FOR THE CONSUMER. PHILIPS SHALL NOT BE LIABLE FOR ANY INCIDENTAL OR CONSEQUENTIAL DAMAGES FOR BREACH OF ANY EXPRESS OR IMPLIED WARRANTY ON THIS PRODUCT. EXCEPT TO THE EXTENT PROHIBITED BY APPLICABLE LAW, ANY IMPLIED WARRANTY OF MERCHANTABILITY OR FITNESS FOR A PARTICULAR PURPOSE ON THIS PRODUCT IS LIMITED IN DURATION TO THE DURATION OF THIS WARRANTY.

Some states do not allow the exclusions or limitation of incidental or consequential damages, or allow limitations on how long an implied warranty lasts, so the above limitations or exclusions may not apply to you.

This warranty gives you specific legal rights. You may have other rights which vary from state/province to state/province.

Philips, P.O. Box 671539, Marietta, GA. 30006-0026

