

XEROX[®]

User's Guide

XM7-22w **LCD Monitor**



©2007 by Xerox Corporation. All rights reserved.

Copyright protection claimed includes all forms and matters of copyrightable material and information now allowed by statutory judicial law or hereinafter granted, including without limitation, material generated from the software programs which are displayed on the screen such as icons, screen displays, looks, etc.

XEROX® is a trademark of Xerox Corporation in the United States and/or other countries.

Changes are periodically made to this document. Changes, technical inaccuracies, and typographic errors will be corrected in subsequent editions.

Table of Contents

CE Marking Declaration Of Conformity	4
Federal Communications Commission (FCC) Statement	5
Important Safety Instructions	6
1 Introduction	
Features	9
Package Contents	10
Front View and Controls	11
2 Installation	
Connecting Your LCD Monitor to a Computer	12
Method 1 : Analog (D-SUB) Connection	12
Method 2 : Digital (DVI) Connection	14
Installing Your LCD Monitor	16
3 On-Screen Display (OSD) Menu	
Using the OSD Menu	18
The OSD Options	19
The picture Options	20
The advanced Options	21
The audio Options	22
The options Options	23
The utilities Options	24
4 Technical Information	
Preset Mode Timing Chart	25
DVI Connector PIN Assignment	26
D-SUB Connector PIN Assignment	27
Plug and Play	28
Troubleshooting	29
Specifications	30
Authorized Service Centers	31

Recycling Place

EUROPE

When disposing of Xerox Branded Monitors in Europe, please contact one of the following three locations to make arrangements for recycling.

- Proview International (UK) Limited
30 The Avenue, Watford, Hertfordshire
WD17 4AE United Kingdom
Timothy Lo
Tel: +44 1923-248-111
Fax: +44 1923-248-222
Email: tim.lo@proview.co.uk

- PGL Europe B.V. (Proview Group Limited Rotterdam)
Satijnbloem 37,
3068 JP
Rotterdam
Hollande
David Hsieh
Tel: +31-10-238-1090
Fax: +31-10-238-1091
Email: david@proview-group.nl

- e-back GmbH
Sondermöninger Straße 5,83339
Chieming
Ullrich Didszun
Tel: +02234/9859-11
Fax: +02234/9859-60
Email: e-back@rde-gmbh.de

ASIA

When disposing of Xerox Branded Monitors in Asia, please contact the following location to make arrangements for recycling.

- Proview Technology (ShenZhen) Co., Ltd.
North Block 21, 23# Shatoukok Free Trade Zone, ShenZhen, China.
Mr. Dennis Chang
Tel: +86-755-2526-1512
Fax: +86-755-2526-1565
Email: recycling@proview.com.cn

AMERICA

When disposing of Xerox Branded Monitors in America, please call the following location to make arrangements for recycling.

- Proview Technology, Inc. (U.S.A.)
7373 Hunt Avenue, Garden Grove, CA 92841 U.S.A.
Patrick Yen
Tel: 714-799-3865
Fax: 714-379-6290
Email: pyen@proview.net

“THIS DISPLAY UNIT IS AN ELECTRIC DEVICE WHICH MAY CONTAIN HAZARDOUS MATERIALS AND COMPONENTS, AND WHICH MUST BE DISPOSED OF AT END OF LIFE ACCORDING TO THE PROPER PROCEDURE”

CE Marking Declaration Of Conformity

This LCD monitor complies with the requirements of the EC Directive 89/336/EEC "EMC Directive" and 73/23/EEC "Low Voltage Directive" as amended by Directive 93/68/EEC. The electro-magnetic susceptibility has been chosen at a level that gives correct operation in residential areas, business and light industrial premises and small-scale enterprises, inside as well as outside of the buildings. All places of operation are characterized by their connection to the public low voltage power supply system.

Federal Communications Commission (FCC) Statement

This equipment has been tested and found to comply with the limits of a class B digital device, pursuant to Part 15 of the FCC Rules. These limits are designed to provide reasonable protection against harmful interference in a residential installation. This equipment generates, uses and can radiate radio frequency energy and, if not installed and used in accordance with the instructions, may cause harmful interference to radio communications. However, there is no guarantee that interference will not occur in a particular installation. If this equipment does cause harmful interference to radio or television reception, which can be determined by turning the equipment off and on, the user is encouraged to try to correct the interference by one or more of the following measures:

1. Reorient/Relocate the receiving antenna.
2. Increase the separation between the equipment and receiver.
3. Connect the equipment into an outlet on a circuit which is different from what the receiver is connected to.
4. Consult the dealer or an experienced radio/TV technician for help.

**CAUTION:**

Changes or modifications not expressly approved by the manufacturer responsible for compliance could void the user authority to operate the equipment.

Important Safety Instructions

To prevent any injuries, the following safety precautions should be observed in the installation, use, servicing and maintenance of this equipment.

Before operating this equipment, please read this manual completely, and keep it nearby for future reference.

Warnings



- Do not place the equipment on any uneven or unstable carts, stands, tables, shelves etc. The equipment may fall, causing serious injury to children or adults and serious damage to the equipment itself.
- Use only a cart or stand recommended by the manufacturer. This equipment and recommended cart or stand should be handled with care. Quick stops, excessive force, and uneven surfaces may cause the equipment and cart/stand to overturn.
- Do not disable the 3-wire grounding type plug. The grounding pin on the 3-prong plug is an important feature. Removing the grounding pin will increase the risk of damaging the equipment. If you can not fit the plug into the electrical outlet, contact an electrician to install a grounding outlet.
- Always operate this equipment from the type of power source indicated on the rear of the serial/model plate.
- Never overload wall outlets and extensions.
- Use and handle the power cord with care.
- Do not place any heavy objects on the AC power cord.
- Do not pull the AC power cord. Do not handle the AC power cord with a wet hand.

- Do not touch the power cord and antenna cable during lightning.
- Remove the plug from the wall outlet if the equipment will not be used for a long period of time.
- Do not place, use or handle this equipment near water.
- Never expose the equipment to liquid, rain, or moisture. Seek qualified service if any of the above is spilled into the equipment.
- Do not attempt to service the equipment yourself.
- Opening and removing the covers may expose you to dangerous voltage or other hazards and may void your warranty. Refer service to qualified personnel.
- Always remove the power cord from the outlet before cleaning the equipment.
- Never use liquid or aerosol cleaners on the equipment. Clean only with a soft dry cloth.
- Do not expose the equipment to extreme temperature or to direct sunlight, as the equipment may heat up and suffer damage.
- Do not install the equipment near any heat sources such as radiators, heat registers, stoves, or any other apparatus that might produce heat.
- Do not block any ventilating openings. Leave an open space around the equipment.
- Never place the equipment on a bed, sofa, rug, or any other similar surfaces; too close to drapes/curtains/walls, in a bookcase, built-in cabinet, or any other similar places that may cause poor ventilation.

(continued on next page)

- If any of the following conditions occur, unplug the power cord from the outlet and request service from qualified personnel.
 - a. The power cord or plug is damaged.
 - b. Liquid is spilled into the product .
 - c. An object falls onto or into the product.
 - d. The product has been dropped or damaged.
 - e. The product's display is abnormal.



DISPOSAL OF WASTE ELECTRONIC EQUIPMENT BY PRIVATE HOUSEHOLDS WITHIN THE EUROPEAN UNION

This sign indicates that this product may not be disposed of with your regular household waste. The recycling and separate collection of such products is your responsibility. Please drop off the above-mentioned waste at a designated place for recycling waste electrical and electronic equipment. If you do not know where to drop off your waste equipment for recycling, please contact your local city office or household waste collection service.

1 Introduction

Features



- **Rapid Video Response**

Fast action media such as gaming, DVD and video conferencing will playback smoothly thanks to the rapid video response time of the LCD panel.



- **High Contrast Ratio**

Vibrant colors, and dark black levels will improve your graphics, photos, or presentations making them life-like and realistic. High contrast levels further define picture detail providing rich saturated images.



- **Very High Resolution**

The 22" wide screen has the outstanding 1680x1050 resolution. It can make the image displayed more precise.



- **Multimedia Enhanced Speakers**

It brings multimedia and saves the desktop space. XM7 display has two built-in 2w stereo speakers and are well integrated into the stylish design.



- **XShield Protective Glass**

The XShield provides extra LCD protection with sophisticated visual flair. The Shield is as hard as quartz (8H hardness) to protect the panel from scratch and enhance the display quality.



- **Multi-Input Selection**

Multi-Input Selection allows having three concurrent sources (PC, Notebook, DVD or game console) share the same one display with simple pressing for switching. No more remove and attach cables all the time. (Only for 2D-SUB+DVI model)



NOTE:

XM7 series LCD monitor may come with (2 D-SUB) or (2 D-SUB and 1 DVI) connectors.

Package Contents

Make sure the following items are in the box. If any items are missing, please return this product to the original place of purchase.

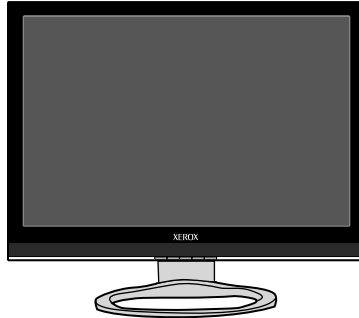

LCD Monitor

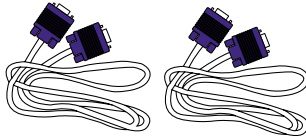

D-SUB Cable
DVI Cable(Optional)



AUDIO Cable



AC
Power Cord



Quick
Guide

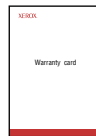

Warranty
Card



CD-ROM
(Driver/Manual)



CAUTION:

Be sure to save original box and all packing material for future transport of monitor.

Front View and Controls

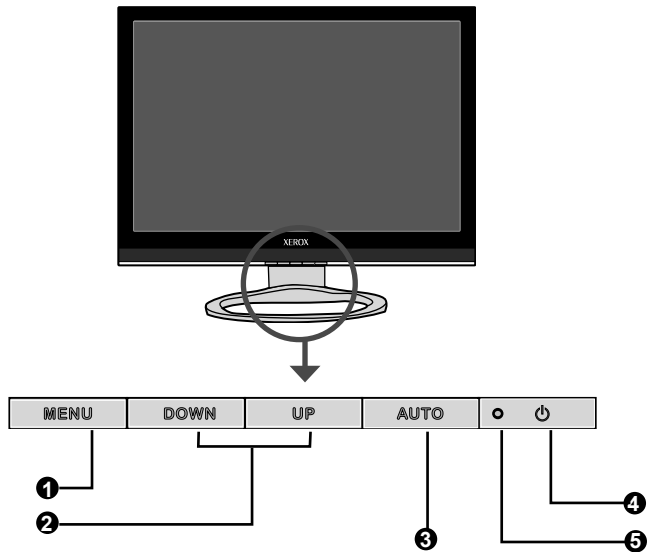

- 1 MENU**
Press once to display the OSD (On-Screen Display). And press to activate the items you highlight .
- 2 DOWN/UP**
In OSD mode, press the **DOWN/UP** buttons to move the selection highlight to the next menu item counterclockwise or clockwise, respectively. Adjusts the volume up and down.
- 3 AUTO**
Press to automatically adjust the display settings to optimize monitor' s performance.
- 4 LED**
The LED light indicates when the LCD monitor is activated (blue light indicates power on and amber light indicates power saving).
- 5** 
Turns the LCD monitor on and off.

2 Installation

Refer to the owner's manual of the computer for connections. In the process of connecting external equipment, do not connect any AC power cords to wall outlets until all other connections are completed.

Connecting Your LCD Monitor to a Computer

Method 1 : Analog (D-SUB) Connection

- 1** Turn off the computer and unplug the power cord.
- 2** Connect the signal cable to the D-SUB port on the back of the computer.
- 3** Connect the audio cable to the out port on the back of the computer.
- 4** Connect the power cord to the LCD monitor and wall outlet.
- 5** Press the  button, located on the bottom side of the main unit to turn the monitor on, then turn the computer on. If the monitor displays an image, the monitor is successfully installed. If no image is displayed, check all connections.

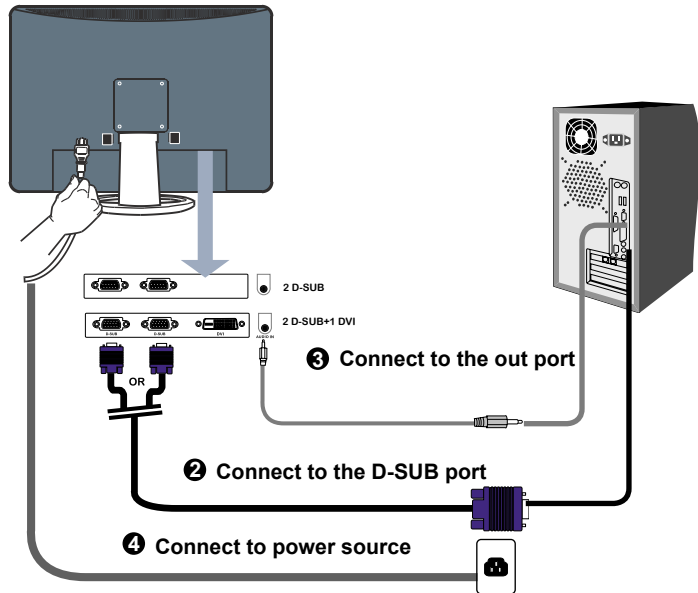
**NOTE:**

XM7 series LCD monitor may come with (2 D-SUB) or (2 D-SUB and 1 DVI) connectors.

**NOTE:**

Unplug the monitor before installation to avoid electric shock or damage.

**NOTE:**

The  button is used for switching the LCD monitor on and off, it does not disconnect the device from the main voltage. To completely disconnect the main voltage, please remove the power plug from the socket.

**NOTE:**

The LED indicator is blue or green when the monitor operates normally and will turn to amber when in power saving mode. When the monitor is off, the LED turns dark.

Method 2: Digital (DVI) Connection

- 1** Turn off the computer and unplug the power cord.
- 2** Connect the DVI signal cable to the DVI port on the back of the computer.
- 3** Connect the audio cable to the out port on the back of the computer.
- 4** Connect the power cord to the LCD monitor and wall outlet.
- 5** Press the  button, located on the bottom side of the main unit to turn the monitor on, then turn the computer on. If the monitor displays an image, the monitor is successfully installed. If no image is displayed, check all connections.
- 6** When the DVI and VGA input ports are connected at the same time, press down the AUTO button after 3 seconds to switch between the VGA mode and DVI mode.

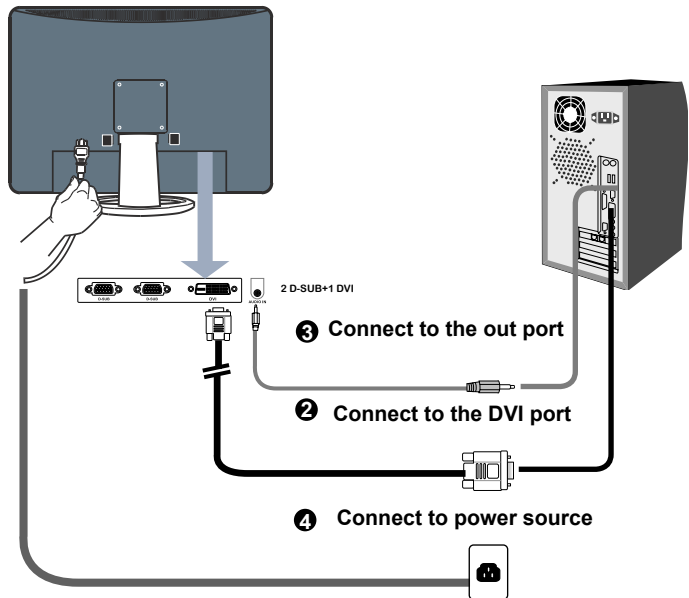

Note: HDCP has been implemented across the DVI interface. The HDCP specification provides a cost-effective and transparent method for receiving the highest quality digital entertainment content from HDMI compliant video sources. (Specified for HDCP models) □□



HOW TO GET SUPPORT FOR YOUR WIDE SCREEN

The wide-screen display enables you to view your content in a brand new way. The next generation of computing environments and game consoles are starting to support wide-screen resolutions.

- Multitask - view applications side by side and reduce toggling between them.
- Enrich - view DVD films in their native wide format for an enhanced multimedia experience.
- Experience - enjoy gaming action at higher wide-screen resolution.

However, to enable wide resolution (**WSXGA+, 1680x1050**), you need to select the correct setting in your **Control Panel>Display>Settings dialog box** in Windows®.

Please note, some video cards and PCs with integrated video may not support the wide-screen resolutions. **You may have to update the video chip/card driver or even purchase a new video card to utilize the advantages of the wide-screen.**

For your PC, refer to the available drivers and downloads from the PC manufacturer's web site. For upgraded video card, refer to the video card manufacturer's web site: nVIDIA® (www.nvidia.com), ATI® (www.ati.com), S3® (www.s3graphics.com), Intel® (www.intel.com), and so on.

Installing Your LCD Monitor

Follow the instructions below to set up and install the monitor.

- 1** The package contains:
1. Display unit
 2. Stand

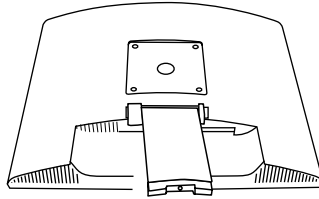

DISPLAY UNIT



STAND

- 2** Cover an even, stable surface with a soft cloth. Place the unit face-down on the cloth. Fit the stand onto the bottom of the display unit as shown.

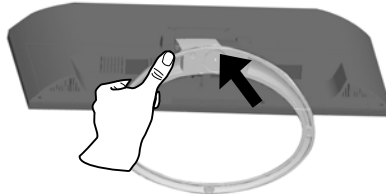

- 3** Use a coin to tighten the screw on the bottom of the stand until the screw is firmly fixed in place.

4

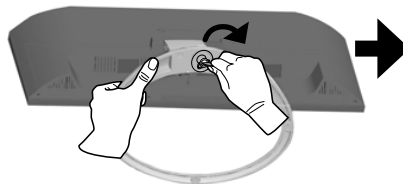

To access the SETTINGS dialog box, go to **START>SETTINGS>CONTROL PANEL>DISPLAY**. Inside the DISPLAY PROPERTIES window, go to the SETTINGS Tab.

If the feature is available, you will find it listed within this dialog box. If you have trouble locating this feature, you might also visit the website of your display driver manufacturer (whose name should be displayed on the **DISPLAY PROPERTIES>SETTINGS** tab) for technical assistance.

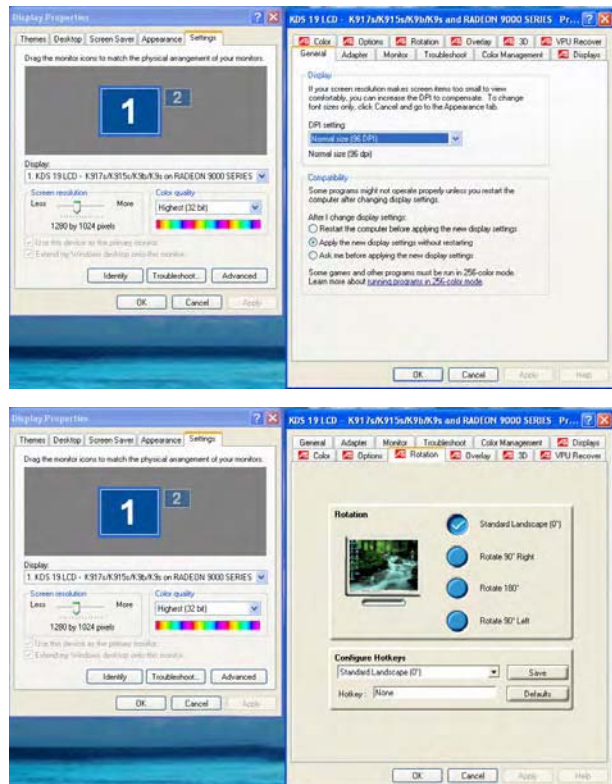

NOTE:

If you find that your display card driver does not offer this feature, you can purchase aftermarket rotation software from manufacturers such as Portrait Displays®. This monitor manufacturer provides no warranty with respect to the use of aftermarket display software.

3 On-Screen Display (OSD) Menu

Using the OSD Menu

To create the best picture, your XM7 series has been preset at the factory with the Preset Mode Timing shown on page 27. The OSD (On-Screen Display) Menu allows the user to adjust various settings and options by following the steps below.

- 1 Press the **MENU** button to display the OSD. The OSD main menu provides an overview of the selection of controls available.

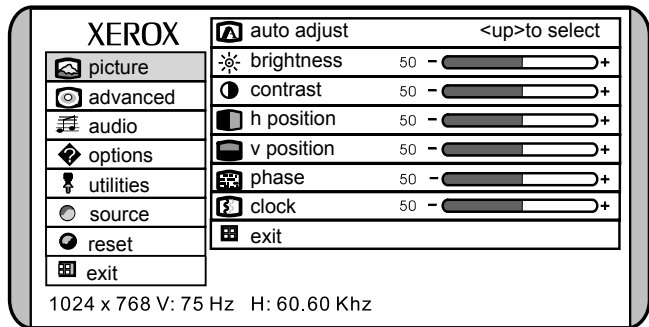

- 2 Press the **DOWN** or **UP** button to highlight the desired icon. Then, press the **MENU** button to activate the highlighted icon.
- 3 Press the **DOWN** or **UP** button to select the desired adjustment icon. Then, press the **MENU** button.
- 4 Press the **DOWN** or **UP** button to change the value of the selected item.
- 5 Select the **exit** icon to exit the OSD.
- 6 Repeat steps 1 through 4 to make further adjustments. All changes are stored immediately.

The OSD Options

The main menu includes the following options:

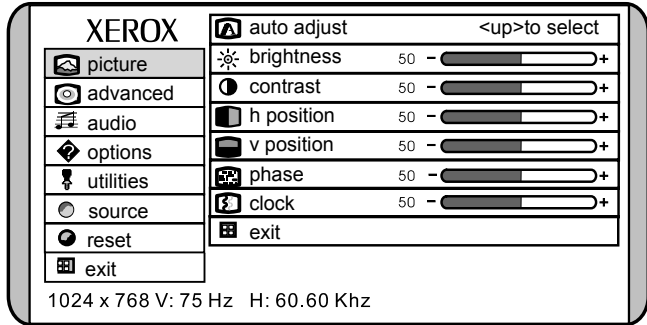

picture

Adjusts picture settings such as brightness and contrast.



advanced

Allows selection of the general color tint: CUSTOM COLOR, WARM, or COOL.



audio

Allows selection of the sound options and effects.



options

Adjusts OSD settings such as Horizontal/Vertical position, H size and phase.



utilities

Adjusts the setting of the display time of the on-screen menu. Allows selection of the language used on all the on-screen menus.



reset

Restores the factory settings.



exit

Exits the on-screen menus.

The picture Menu

- 1 The picture menu provides access to the following menus:

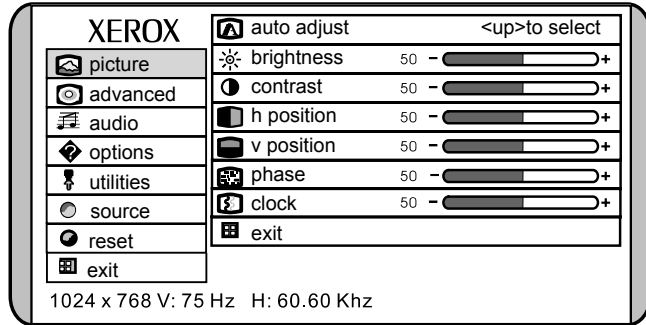

- 2 The picture menu includes the following options:

 **auto adjust**

Automatically adjust the display settings to optimize monitor's performance.

 **brightness**

Controls the overall brightness.

 **contrast**

Controls the difference between the brightest and darkest regions of the picture.

 **h. position**

Adjusts the position of the picture left and right in the window.

 **v. position**

Adjusts the position of the picture up and down in the window.

 **phase**

Adjusts signal phase, which can improve focus clarity and image stability.

 **clock**

Adjusts the width of the picture.

 **exit**

Exits the picture menu.

The advanced Menu

- 1 The advanced menu provides access to the following menus:

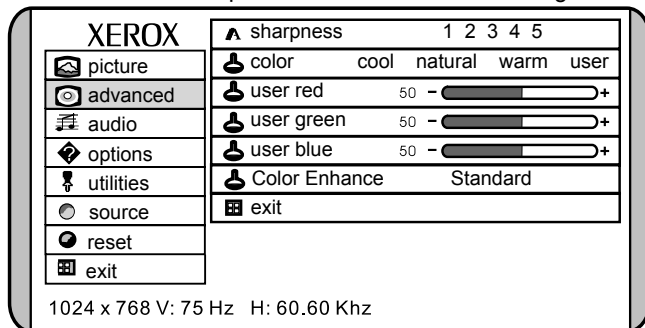

- 2 The advanced menu includes the following options:

▲ sharpness

Increase this setting to see crisp edges in the picture; decrease for soft edges.

👤 color

Allows selection of the general color tint: user, natural, warm, or cool.

cool

Inclines colors toward the blue end of the spectrum. Fixes the red, green and blue component levels at factory settings; they cannot be independently adjusted.

natural

Inclines colors toward the natural end of the spectrum. Fixes the red, green and blue component levels at factory settings; they cannot be independently adjusted.

warm

Inclines colors toward the red end of the spectrum. Fixes the red, green and blue component levels at factory settings; they cannot be independently adjusted.

user

Allows the user to adjust red, green and blue color component levels independently.

🏠 exit

Exits the advanced menu.

The audio Menu

The audio menu provides access to the following menus:

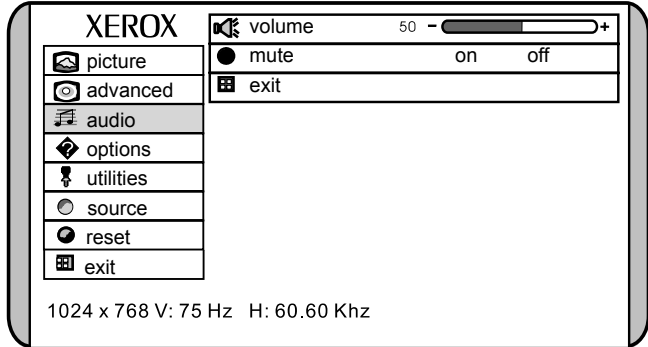

2 The audio menu includes the following options:

 **volume**

Adjusts the speaker volume up and down.

 **mute**

Mutes and restores the monitor speaker sound.

 **exit**

Exits the audio menu.

The options Menu

1 The options menu provides access to the following menus:

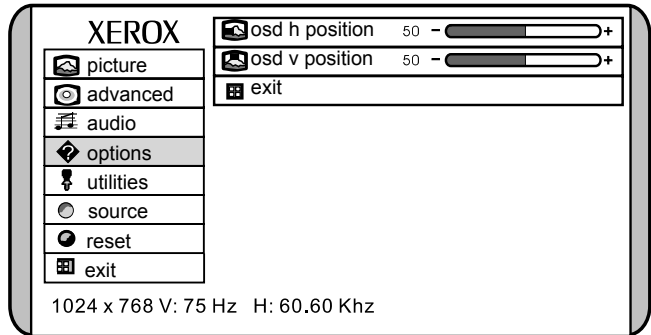

2 The options menu includes the following options:



osd h. position

Moves the OSD left and right in the window.



osd v. position

Moves the OSD up and down in the window.



exit

Exits the OSD menu.

The utilities Menu

- 1 The utilities menu provides access to the following menus:

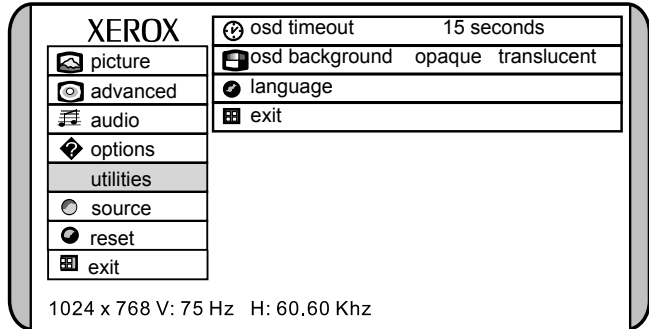

- 2 The utilities menu includes the following options:

 **osd timeout**

Allows selection of the display time of the on-screen menu. after last entry made.

 **osd background**

Controls the translucence of the on-screen menu's background.

 **languages**

Allows selection of the languages used in all the on-screen menus.

 **exit**

Exits the utilities menu.

4 Technical Information

Preset Mode Timing Chart

The screen image has been optimized during manufacture for the display modes listed below.

Video signal: (IBM PC/AT)

Dot X Line	Horizontal Frequency(kHz)	Vertical Frequency(Hz)
720 x 400	31.47	70.00
640 x 480	31.47	60.00
	37.50	75.00
800 x 600	35.16	56.25
	37.88	60.30
	46.87	75.00
1024 x 768	48.36	60.00
	60.02	75.00
1280 x 1024	63.98	60
	79.98	75
1440 x 900	55.47	59.90
	70.64	74.98
1680 x 1050	64.67	60

DVI Connector PIN Assignment

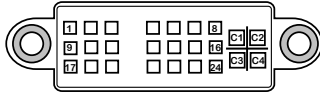

PIN	DESCRIPTION	PIN	DESCRIPTION
1	TMDS Data 2-	15	GND
2	TMDS Data 2+	16	Hot Plug Detect
3	TMDS Data 2/4 shield	17	TMDS Data 0-
4		18	TMDS Data 0+
5		19	TMDS Data 0/5 shield
6	DDC Clock	20	
7	DDC Data	21	
8	Analog Vertical Sync	22	Clock shield
9	TMDS Data 1-	23	Clock +
10	TMDS Data 1+	24	Clock -
11	TMDS Data 1/3 shield	C1	Analog red
12		C2	Analog green
13		C3	Analog blue
14	+5V Power	C4	Analog

D-SUB Connector PIN Assignment

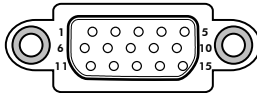

PIN	DESCRIPTION
1	Red
2	Green
3	Blue
4	Ground
5	Self Test
6	Red Ground
7	Green Ground
8	Blue Ground
9	5 VDC
10	Ground
11	Ground
12	SDA (FOR DDC)
13	H. Sync
14	V. Sync
15	SCL (FOR DDC)

Plug and Play

This monitor conforms to the VESA DDC (Display Data Channel) standard, which means that when it is used with a DDC compatible video card, the monitor is easier to set up. With VESA DDC 1/2B, when the monitor is turned on, it will automatically notify a windows 9X/2000/XP host computer of its scanning frequencies, capabilities and characteristics. Windows 9X/2000/XP will automatically recognize the presence of the monitor and select the appropriate display resolution.

Troubleshooting

Before consulting service personnel, check the following chart for a possible cause and solution to the trouble you are experiencing.

Monitor will not turn on

- Make sure the power cord is plugged in.

No picture

- Make sure the power cord is plugged in.
- Check the signal cable connecting the LCD monitor and the computer (refer to page 12-15).
- Press the  button on the front panel of the monitor.

Poor picture or abnormal picture

- Check the signal cable connecting the LCD monitor and the computer (refer to page 12-15).
- Press the **MENU** button to adjust the Brightness and/or Contrast options in the OSD.
- Adjust the Color Select option in the OSD.
- Press the **AUTO** button on the front panel of the monitor to automatically adjust the display mode.

Out of range message appears

- Press the **AUTO** button on the front panel of the monitor, to automatically adjust the display mode.
- Press the **MENU** button to adjust the V Position, H Position and H Size options in the OSD.
- If using Windows 9X/2000/XP, wait a few seconds; once Windows detects the problem, a dialog will appear allowing you to manually set up the video mode according to the preset mode timing chart (refer to page 27).

Specifications

MODEL		XM7-22w
LCD Panel	Panel Size	22" w TFT LCD
	Brightness	300
	Dot Pitch	0.282mm x 0.282mm
Panel surface		anti-reflecting coating
Speakers		Built-In
Max. Resolution		1680x1050
Input Connector		D-SUB x 2/ DVI x 1/PC AUDIO or D-SUB x 2/PC AUDIO
Power Source		AC100-240V, 50-60Hz
Power Consumption		60W
Dimension		523x404x220 mm

Changes are periodically made to above specifications.
Current specifications may also be obtained via the internet at:
[www.xerox-displays.com\(US\)](http://www.xerox-displays.com(US)) or [www.xerox-displays.info\(Europe\)](http://www.xerox-displays.info(Europe)).

Authorized Service Centers

U.S.A.
CALIFORNIA: AUTHORIZED SERVICE CENTER
7373 HUNT AVENUE
GARDEN GROVE, CA 92841
(714) 799-3899
(800) 469-1175
(714) 379-6290 Fax
Hours: 8AM ~ 6PM - Pacific Standard Time

TEXAS: AUTHORIZED SERVICE CENTER
10849 KINGHURST SUITE # 120
HOUSTON, TX 77099
(281) 530-4100
(281) 530-4104 Fax
Hours: 8AM ~ 6PM - Central Time

EUROPE
AUTHORIZED SERVICE CENTER CONTACTS:
XOAL BVBA
RAKETSRAAT 100
B-1130 BRUSSEL BELGIUM
E-EMAIL: rma@proview-repair.com
<http://www.proview-repair.com>
Hotline: 00800 00 88 77 66
Fax: +32-2-725-2513
Hours: 10AM ~ 12PM and 2PM ~ 5PM
Monday through Friday

RUSSIA
NBI (National Bureau of Informatization):
AUTHORIZED SERVICE COMPANY
Pervomayskaya str., 126, 105203 Moscow, Russia
(495) 231-3051
(495) 965-0946, 797-80-44 Fax
Email: info@bi.ru
www.nbiservice.ru

