

BEKO

INTEGRATED DIGITAL HD READY COLOUR TELEVISIONS

26WLK530HID

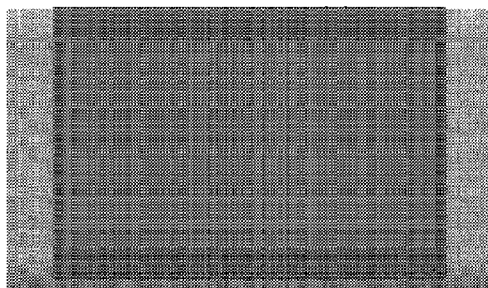

Operating Instructions



List of contents

Important Information	4
Special features	5
Safety instructions	6
Getting started	7
Aerial connection	7
Switching on	7
Battery fitting	7
Control unit	8
Remote control	9
Using the TV	10
Tuning the TV	11
Automatic tuning (Digital and Analog)	11
Manual tuning	12
Electronic program guide (Digital)	13
Program organising	14-15
TV setup	16
Sound menu	16
Picture setup	17
Features Menu	18-19
Digital TV menu	20
Using teletext	21-22
Connecting external equipment	23-27
Help and service tips	28
Technical specifications table	29
Main Uk Transmitter Stations	30
Guarantee	31-32

Important Information

LCD display panels are manufactured using an extremely high level of precision technology, however sometimes some parts of the screen may be missing picture elements or have luminous spots. This is not a sign of a malfunction.

Cleaning the screen and the cabinet...

After turning off the power, clean the screen and the cabinet with a soft, dry cloth. We recommend that you do not use any proprietary polishes or solvents on the screen or cabinet as this may cause damage.

Disposal...

The cold cathode fluorescent lamp in the LCD panel contains a small amount of mercury, when the set reaches the end of its useful life please dispose of it in accordance with Local Government Regulations or at a recycling centre.

Connection of Mains Cable

Always use the mains cable supplied. First of all insert the mains cable into the input panel of the CTV, and only there after in to mains supply socket.

ELECTRICAL CONNECTIONS

For your own safety read the following instructions carefully before attempting to connect this unit to the mains supply.

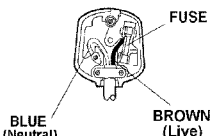
<p>IMPORTANT The wires in the mains lead are coloured in accordance with the following code: Blue – Neutral Brown – Live As the colours in the mains lead of this</p>  <p>BLUE (Neutral) BROWN (Live)</p>	<p>appliance may not correspond with the coloured markings identifying the terminals in your plug. proceed as follows: The wire which is coloured blue or black must be connected to the terminal which is marked with the letter N or coloured Black. The wire which is coloured brown or red must be connected to the terminal which is marked with the letter L or coloured Red. No connection is to be made to the Earth terminal of the plug. If a 13 Amp (BS1363) Plug is used, fit an ASTA approved 3, 5, or 13 Amp fuse as required. If your product is fitted with a moulded plug which requires replacement please cut off and dispose of safely, then rewire as shown above.</p>
---	---

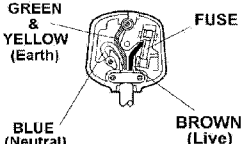
<p>IMPORTANT The wires in the mains lead are coloured in accordance with the following code: Blue – Neutral Brown – Live Yellow/Green – Earth As the colours in the mains lead of this</p>  <p>GREEN & YELLOW (Earth) BLUE (Neutral) BROWN (Live)</p>	<p>appliance may not correspond with the coloured markings identifying the terminals in your plug. proceed as follows: The wire which is coloured green and yellow must be connected to the terminal which is marked with the letter E, or by the earth symbol, or coloured green or green and yellow. The wire which is coloured blue or black must be connected to the terminal which is marked with the letter N or coloured Black. The wire which is coloured brown or red must be connected to the terminal which is marked with the letter L or coloured Red. If a 13 Amp (BS1363) Plug is used, fit an ASTA approved 3, 5, or 13 Amp fuse as required. If your product is fitted with a moulded plug which requires replacement please cut off and dispose of safely, then rewire as shown above.</p>
--	--

Caution: -Under no circumstances should the discarded plug be inserted into a mains socket. To prevent shock hazard carefully dispose of the discarded plug into your dustbin, do not leave the plug lying around where children might see it.

Television

Thank you for buying this television which is designed to give you many years of satisfactory service.

You may already be familiar with using a television but do please take time to read these instructions. They are designed to familiarise you with the unit's many new features and to ensure you get the very best out of your purchase.

Special Features

- 26" TFT-LCD WXGA Panel
- HD Ready
- Available for Cable Channels (A decoder may be required)
- 2x7 W Stereo sound
- 800-Page Teletext Feature
- PIP (Picture in Picture) Feature
- Wide angle perspective
- 2 SCART sockets, AV out Socket
- HDMI input
- S-VHS and Phono inputs for S-Video connection
- PC connection
- CI Slot
- Minimum energy consumption
- AVL – Automatic Volume Limiting
- ATS – Automatic Tuning System
- Programmed on/off Timer
- Graphic equalizer
- Colour Transfer sharpness feature (CTI)
- Black-White Transfer sharpness feature (LTI) and picture sharpness
- Compound Filter (Digital Comb Filter) Feature for clear images
- On screen viewing of all control commands, program numbers and additional features
- Manual Fine Tuning
- 100 Analog Channel Memory
- Infrared Remote Control
- Panel Lock
- Ability to watch NTSC video playback through SCART input
- Easy handling through an advanced menu system. Ability to choose from 23 languages.
- 1000 Digital Channel Memory
- Adjustable 4 favorite list
- 8-Day EPG (Electronic Program Guide)
- Integrated Digital Receiver
- MHEG - 5
- DVB Subtitling
- OAD (Over Air Download)



HDMI, the HDMI logo and High-Definition Multimedia Interface are trademarks or registered trademarks of HDMI Licensing LLC.



- Cover a table with a soft towel (or other protection to prevent damage to the TV or table)
- Carefully lay the TV front down on the table.
- Position the TV stand so that it hangs over the edge of the table.
- Remove the 5 screws that hold the stand.
- Remove the stand.
- Attach any new brackets before lifting the TV backup.

Note: Keep removed stand and screws safely for future use.

Safety is Important

Your safety and the safety of others is important. Please, therefore, ensure you read the Safety instructions **before** you operate this television.

Safety instructions

 Read all the safety instructions before first use of your TV.



- Position the television so that direct light does not fall on the screen. Excessive light will cause a washed out effect.



- Position the power supply lead and other leads so that they are not likely to be walked on or pinched by things placed on or against them.



- Do not place objects filled with liquid such as a vase or flower pot near or on the television.
- Do not expose the TV to dripping or splashing of liquids.
- Do not place naked flame sources such as lighted candles on or next to the TV set.



- Make sure that no naked flame sources, such as lighted candles, are placed on top of the appliance.
- Do not place the television near heat sources such as radiators, ovens, stoves, etc.



- Do not push, hit or screw into the screen of your product.



- The heat built up in the set escapes through ventilation holes, so do not cover the set by drapes, clothes etc. that may block air circulation. Do not place the television on carpet or soft furnishings. Leave a minimum of 10cm gap around all sides of the TV unit.



- Never let children push anything into the holes or slots on the case.
- Clean the TV Screen using a slightly damp cloth or chamois leather. Never use abrasive cleaning agents like liquid or aerosol cleaners.
- Remove the mains plug from the socket outlet while cleaning.



- Never apply pressure on the screen when cleaning.
- Never put your screen on hard objects. Your TFT screen may be damaged.



- If you wish to place the television on a shelf or in a wall unit always ensure there is a minimum air gap of 10 cm around the top, sides and rear of the television, to assist ventilation.



- Your TV set is designed to operate with mains voltages 230V AC; 50Hz. Do not connect your TV set to power sources other than the mains supply.
- If you don't use the television for a long period, please remove the mains plug from wall socket outlet.
- To fully disconnect the TV, the mains plug is used as a disconnecting device and therefore shall be readily operable.

Getting started

Remove your Television carefully from the box. You may wish to store the packaging for future use.

In the box

Inside the carton box you should have:

- Accessories box
- Power cord
- Remote control
- Batteries
- Instruction Book

Note: Scart, VGA, PHONO and HDMI Leads are not supplied.

Read these instructions before use.

Aerial connection

To connect an aerial, plug the aerial lead into the aerial socket on the rear of the TV.

1. The availability of Freeview digital terrestrial services in your home depends on your local transmitter and the configuration of your existing reception equipment.

2. You should have already checked your postcode to see if you are in a Freeview coverage area. If not please contact Freeview immediately:
Call 08708 809980

Text your postcode to 83331

Visit www.freeview.co.uk

3. If you are in a Freeview coverage area but are unable to receive all available channels for your location, it is recommended you have a site survey by a professional aerial installer to ensure aerial alignment and 'line of site' to the transmitter are optimised. If you do not know of a local aerial installer, please call the Confederation of Aerial Industries (www.cai.org.uk) on 0208 902 8998 who will be able to recommend one.

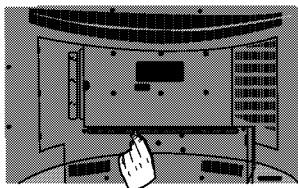

You can use an outdoor or indoor aerial. However, if you use an indoor aerial the quality of the reception may be reduced and adjustment of the aerial may be required when changing programs.

Please note

If you live in a poor reception area or use an indoor aerial you may experience loss or corruption of teletext transmissions.

Switching on and First Use

- 1.** Connect the mains lead to the socket at the back panel of the LCD TV.
- 2.** Connect the mains plug to a suitable mains socket.

Note 1: Your TV will go to stand-by mode in five minutes if there is no broadcast signal.

Note 2: Your TV is equipped to operate from the control buttons on the cabinet. In case your R/C is broken or the batteries are exhausted.

Please Note

When not in use disconnect the mains plug from the mains supply.

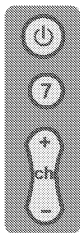

3. Press the **Power** button on the cabinet of the TV. The standby indicator will illuminate.

4. Press a numeric button or the **Program Up / Program Down** button on the remote handset or **Program Up / Program Down** on the cabinet of the TV to switch the TV on. The picture will appear after a few seconds.

Please Note

Do not leave the television in standby unattended or overnight.

Switching the TV on for the first time

To install your TV, please read the sections "TV controls" and "Tuning the television".

The batteries

Remove the back cover to reveal the battery compartment and make sure you insert the batteries the right way round.

Suitable battery types for this remote are UM-4, IEC R03 or AAA 1.5V.

Do not throw your old batteries into a fire, dispose of them in a designated disposal area.

Do not combine a used, old battery with a new one or mix battery types.

The performance of the remote control will deteriorate beyond a distance of 8 metres or outside an angle of 30 degrees from the centre of the TV.

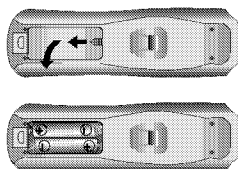

Control Unit

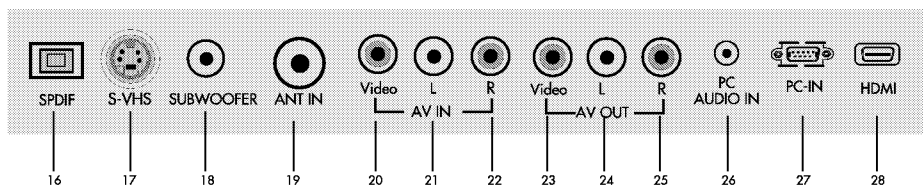
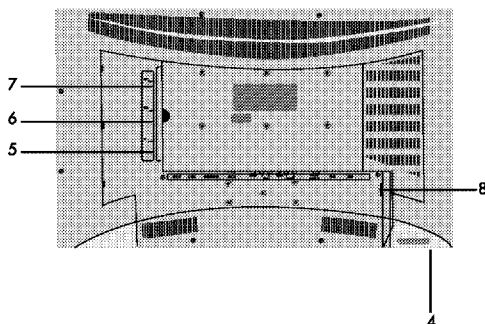
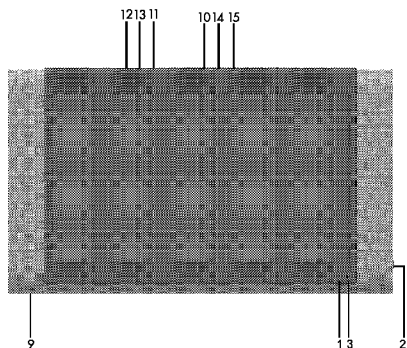

- | | |
|--------------------------|--|
| 1. Stand-by | 15. Program up |
| 2. Power on / off | 16. SPDIF |
| 3. Remote control | 17. S-VHS (S-Video in source menu) |
| 4. Headphone jack | 18. Subwoofer Output |
| 5. CI Input | 19. Aerial input |
| 6. Scart 2 | 20. AV IN input Phono connector (Select AV in source menu) |
| 7. Scart 1 | 21. AV IN or S-Video Phono Connector (L) (Select AV in source menu) |
| 8. Power Input | 22. AV IN or S-Video Phono Connector (R) (Select AV in source menu) |
| 9. Speaker | 23. Video output Phono connector (See page 18 - Scart2 Output) |
| 10. Source Select | 24. Audio Phono output (L) (See page 18 - Scart2 Output) |
| 11. Menu button | 25. Audio Phono output (R) (See page 18 - Scart2 Output) |
| 12. Volume down | 26. PC sound input |
| 13. Volume up | 27. VGA (PC input) |
| 14. Program down | 28. HDMI |

Please note

- Do not use Video PHONO and S-Video connections at the same time, otherwise they will each effect the performance of the other.
- RGB inputs from scarts will give you better picture quality than PHONO or S-VHS inputs when connecting to an external device.

Remote control

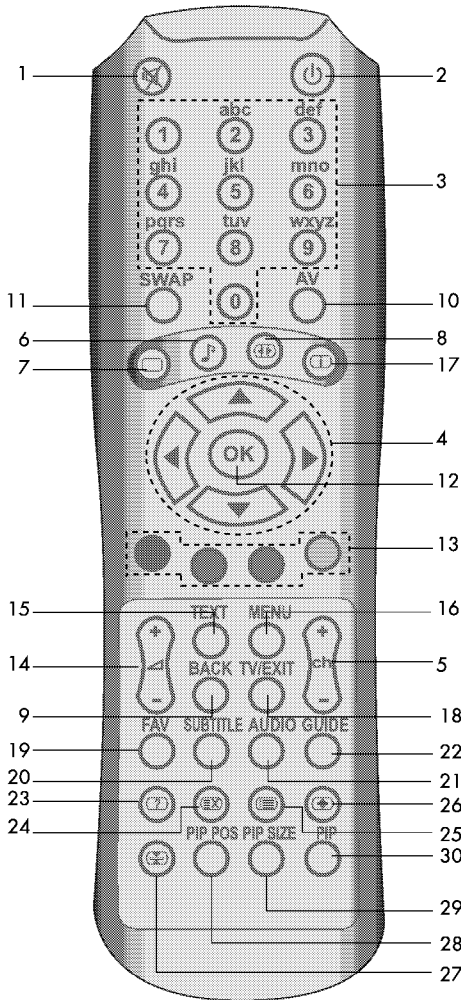

1. Mutes the sound (⊘).
2. Puts TV into and out of standby mode (⏻).
3. Used for any numeric input.
4. Navigation in menus.Functions in interactive applications.
Change teletext pages.
5. Program position up and down (⏮).
6. Selects pre-defined sound modes or customer-own one (🎵).
7. Selects pre-defined picture modes or customer-own one (🖼️).

8. Selects preset picture modes or customer setting (🖼️).
9. Functions as Exit\Cancel key in interactive applications.
10. Displays all possible sources ATV, DTV, AV1, ..., HDMI, etc.
11. Swaps between current program and previous one.
12. Select in menus and interactive applications (OK).
13. Functions in teletext and interactive applications.
14. Increase and decrease volume level (🔊).
15. On\Off analog teletext or digital interactive applicaitons. When in teletext mode, mix key is used for mixing teletext and analog video.
16. Displays menu.
17. Displays info banner in digital mode. Moves to index page in teletext mode (📄).
18. Exit OSD or interactive applications. Move from any souce to TV.
19. Displays favorite lists.
20. Displays subtitles.
21. Selects possible audio available
Selects dual I-II for analog.
22. Displays Electronic Program Guide (EPG) in digital mode.
23. Reveals concealed text in teletext page (📄).
24. Selects a page while watching TV (📄).
25. Allows access to subpages within a teletext page (📄).
26. Doubles the size of teletext characters (📄).
27. Hold a desired page (📄).
28. Displays PIP position menu for PIP position.
29. Resizes PIP window.
30. Activates PIP menu for PIP operations.

Using the TV

Turning on for the first time and Tuning

TV controls

Temporary On-Off (STAND-BY)

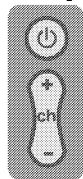

Press the red (⏻) stand-by button (temporary on-off function) located on the upper right hand side of your remote control, or on the front panel of your television. When it is switched on the unit will go into stand-by.

To switch your television back on, either press the same button, any of the number buttons or one of the (1) buttons.

Caution!

If you are not going to use your television for a long period of time, make sure to switch it off from the main power button.

When you first switch it on, the Language menu appears.

1. Select the menu language by pressing (↵) or (↵).

2. Select Country with (←) or (→) and then select the country where you are located with (↵) or (↵).

3. Select autoprogram with (←) or (→) and press (OK) to start the search.

- The automatic station search starts. This may last a minute or longer, depending on the number of television stations received.
- After the search, the station list appears. You can delete any stations which have been saved more than once.

SOURCE Menu: Pres the AV key of the remote control. The SOURCE menu which is shown below appears on the screen. From this menu switching to the "Analogue TV" "Digital TV" "PC" is possible. You may select the modes "Scart 1" "Scart 2" "S-Video" "AV" "HDMI" "YPbPr".

SOURCE
Analogue TV
Digital TV
Scart 1
Scart 2
S-Video
AV
PC
HDMI
YPbPr
*OK*SELECT

Programme selection

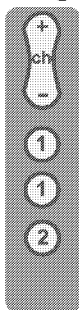

Press the (1) buttons on your remote control, or use numeric buttons in order to switch to the desired channel on your television. In order to select a program whose number is greater than 9, you can use the numeric buttons, inputting the desired numbers as required. For example, to select program 12, press the numeric buttons 1 and 2 one after another.

AUTO TUNING			
79%			
Programme	Type	CA	Quality
800	BBC THREE	[]	[]
801	BBC NEWS 24	[]	[]
802	BBC1	[]	[]
803	CBBC Channel	[]	[]
804	BBC TWO	[]	[]
805	BBC ONE	[]	[]

EXIT to cancel
 Page Up Page Down

Mute

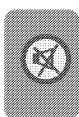

To temporarily mute the sound of your television, press the (M) button, whereby the (M) on screen display will appear on screen as an indication of the application.

When you press the same button again, the sound will return. In the mute position, when you press the (1) key, the sound is turned down but the Mute position is not aborted, if you

press the (1) button the volume will increase and automatically switch out of the mute function.

Return to Selected Button Program (SWAP)









If you wish to return to the previous program that you were watching then you have the ability to return with a single function, by pressing the (SWAP) button.

Regardless of whether you are at AV, or any other program, by using the SWAP function allows you to swap between the program you were watching and the last selected program. If you hit the same button again, you will return to the program or AV you were watching before.

PR 01 ➔ (SWAP) PR 11 ➔ (SWAP) PR 01

Control Menu

Press the  button. You will see the MENU with all the headings of the different controls on screen. The Up/Down buttons () or () enable you to select between the different Sub-menu titles. Enter a Sub-menu by pressing the  or Up/down () or () button.

to exit the application at any given stage, simply press the MENU or TV button. Pressing menu while in a Sub-menu returns you to the previous menu.

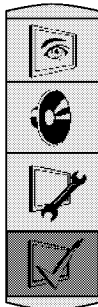

Tuning the television

You can either tune the programs automatically or manually storing them in your television.

Please Note

In the case that your television does not receive any broadcast signals for 5 minutes it will automatically go to stand-by. The 5 minute countdown OSD will be displayed on screen.













Automatic tuning and storing of the television program channels with ATS (DIGITAL and ANALOGUE).

Select digital or analog TV in the source menu by pressing the AV button on your remote control.

The ATS (Automatic Tuning System) on your television enables the automatic finding and sorting of channels.

Sorting is done according to the selected country channels, which broadcast Teletext and channel names; followed by all channels with Teletexts without channel names and then by channels without Teletext, to be concluded by foreign channels broadcasting Teletext with channel names.



The setup menu is accessed via the menu button. The setup sub-menu is selected by means of the up-down button. The Setup menu is accessed using the  button or the  button. The  button or the  button is pressed to enter the Auto-tuning process. The ATS menu appears on the screen. The country selection is done via the  or  buttons. The autoprogram title is selected by means of the  or () buttons, it is confirmed via the  or () or () buttons. A Warning appears on the screen; the search is started via the  button or it is cancelled using the  button.



SETUP	
Auto Tuning	▷
Manual Tuning	▷
Program Management	▷



ATS	
Country	◀ UK ▶
Autoprogram	

Manual tuning and storing of the Digital television channels



The setup menu is opened via the **MENU** button. The setup title is selected by means of the **Page Up** or **Page Down** button. The Setup menu is accessed using the **OK** button or the **Page Down** button. The **Page Down** button is pressed to enter the Manual tuning process. The manual tuning screen appears.

The manual search is started via the **Page Down** button, when a channel is found, it is added to the list; the **Page Up** button must be pressed again for the next channel. The channel is saved in memory by pressing the yellow **OK** button. It is possible to navigate the page up and down via the red and green **Page Up** button. The selected channel appears on the screen by means of the **EXIT** button."

Note: To manually tune digital television channels, you must have Digital selected as source. Press AV and select Digital as Source, confirm with the OK button.

Manual tuning and storing of the Analogue television channels :

The setup menu is accessed via the **MENU** button. The setup sub-menu is selected by means of the **Page Up** or **Page Down** button. The setup menu is entered using the **OK** button or the **Page Down** button. Before starting the tuning process, the number at which the channel to be stored is entered in the program no. tab. Using the **Page Up** or **Page Down** buttons, the system tab is accessed and it is determined via the right-left side buttons in which system the channels are to be selected. This should be set to I for U.K. The search is started by means of the **Page Up** or **Page Down** buttons in the

search tab. The located channel is confirmed by selecting the store tab and pressing **OK**. The same process is repeated for the other channels, to.

Note: To manually tune Analogue television channels, you must have Analogue selected as source. Press AV and select Analogue as Source, confirm with the OK button.

Note: Tuning can also be carried out by selecting channel line while in setup sub-menu; and using **Page Up** or **Page Down** buttons until the desired broadcast is found. This then needs storing as explained above.

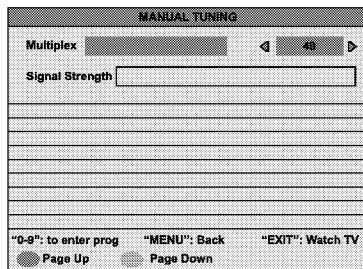

Choose band tab accordingly. The default is C for Aerial connection however select S-Band for cable channels directly connected to tuner.

Fine Tuning



If the current channel requires fine tuning, select the Manual Fine Tuning bar by using the down **Page Down** button in the Manual Tuning menu. Using the right-left movement **Page Up**/**Page Down** buttons on your remote control you will have the ability to get the exact quality of tuning required. Under normal conditions you will not need Fine Tuning. Your television will automatically lock channels, which need AFC values. However, in the event that the TV transmitters do not work, then you may need to use this process. For storing the settings to the memory press **OK** button.

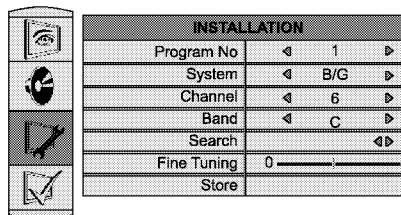

8-Day EPG (Electronic Program Guide)(Digital)

8-Day EPG can be started by pressing GUIDE (GUIDE) button on the remote control. By pressing (Left Arrow)/(Right Arrow) or red and green (Red Arrow)/(Green Arrow) buttons you can move along the channel list and choose a channel. Left and right (Left Arrow)/(Right Arrow) buttons are used to move along the bar where the hours are shown. Press (OK) to watch the selected channel. To enter SET TIMER menu press blue (Blue Arrow) button, you can choose a program and set it's starting and ending time by using **set timer** menu. You can also select the subtitle and audio language of the program from this menu. Pressing the GUIDE (GUIDE) or TV/EXIT (TV/EXIT) button, will close the EPG menu.

13:05, Mon, 20 December					
2 BBC TWO	14:05 - 15:30				
My Favourite Wife - After being ship-wrecked for seven years, Ellen (Irene Dunne) returns home on the day that her husband Nick (Cary Grant) is having her declared legally dead so that she can remarry. [1940, b&w]					
Programme	13:00	14:00	14:30	15:00	15:30
1 BBC ONE	Look No	Cash in the Attic	Cool Runnings		
2 BBC TWO	Penny Serenade	My Favourite Wife			
7 BBC THREE	This is BBC THREE				
30 CBBC Channel	Slig of the Dump		Loon	Animadness	
40 BBC NEWS 24	BBC News	BBC News	BBC News		
8-Day	8-Day	Tuesday	Wednesday	Thursday	Friday
"Up/Down" for service		"Ch Up/Down" for day selection		"OK" to watch	
Page Up	Page Down	Time			

Note 1: 8 day EPG will only work when source is selected as digital tv.

Note 2: To go to another day, press ch up/down.

Program management (Digital)

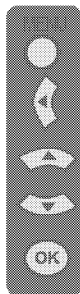

The setup menu is opened via the button. The setup title is selected by means of the button. The setup menu is entered via the button and the button. Using the or side buttons, the tab program management is selected. The program management menu appears by means of the button or the button. In this menu, a channel can be erased, navigation can be done on the page via the or buttons. The channels can be added to the desired favourites list.

Program Management (Analogue) :

The setup menu is opened via the button. The setup title is selected by means of the or button. The setup menu is entered via the button and the button. Using the or side buttons, the tab program management is selected. While on the tab, the button or the arrow button is pressed, the program management menu appears. In this menu, it is possible to erase a channel, relocate it, rename it or remove it from the list.

Switching the locations of the analogue program channels that have already been stored



The processes can be done while on the program management (analogue) menu. Select the program you want to switch by using the or or button. Press the Green coloured button.

number and name will appear green. Using the or or Right-left buttons carry it to other program location you want to switch to. To finish the switching press the Green button. All channels stored above the new location are shifted up one place.

Favorite List (Digital)

Store your favorite channels to navigate your way around quickly, easily and avoid browsing channels that you don't wish to view. Make sure that Digital TV is selected from the source menu. Press Menu on your remote control and select setup using buttons. Press right button to enter setup menu. Select Program management with buttons and press to enter. To add the channels to the favorite list use , buttons to scroll through the channel list and press to select a check mark will appear next to the channel name, and the channel will be added to your favorite list. You can deselect the channels by applying same steps. When you deselect the channel the check mark will disappear and the channel will be removed from your favorite list. You can add channels to more than one favorite list. You can reach favorite list by pressing button on your remote control.

FAVOURITE LIST	
ALL	
FAV1	
FAV2	
FAV3	
FAV4	
OK to select	*EXIT* to cancel

PROGRAM MANAGEMENT						
Programme	Type	CA	FAV1	FAV2	FAV3	FAV4
1 BBC ONE						
2 BBC TWO			✓			
7 BBC THREE				✓		
30 CBBC Channel					✓	
40 BBC NEWS 24			✓	✓	✓	
51 BBC1						

OK: to tick *MENU*: Back *EXIT*: Watch TV
 Page Up Page Down Delete

Note 1: When you are in a favourite list, you can only select the channels within the list. Your tv will ignore any attempt to switch to a non favourite channel.

Note 2: The 8-day guide (EPG) will only display the channels that are in the favourite list selected.

Note 3: To exit the favourite list press (FAV) key on your remote control and select "ALL" from the window.

Deleting a program that has been stored (Analogue)



The processes can be done while on the program management (analogue) menu. Select the program you want to delete by using the (←) or (→) button or Right-left (↵) button. Press the Blue (●) coloured button. The screen will show the confirmation menu. You can press the Green (●) button to delete or the Red (●) button to exit the menu.

When you press the Green (●) button, the selected channel will be deleted and all following channels will move up in their position accordingly.

001 BBC ONE	11----	S	21----	S
002 BBC TWO	12----	S	22----	S
003 ITV 1	13----	S	23----	S
004 CHANNEL 4	14----	S	24----	S
005 FIVE	15----	S	25----	S
006 ITV 2	16----	S	26----	S
007 BBC THREE	17----	S	27----	S
009 BBC FOUR	18----	S	28----	S
010 ITV 3	19----	S	29----	S
011 SKY THREE	20----	S	30----	S
Skip		Name		
Move		Delete		

Deleting a program that has been stored (Digital):

The setup menu is opened via the (MENU) button. The setup title is selected by means of the (←) or (→) button. The setup menu is entered via the (OK) button and the (↵) button. Using the (←) or (→) buttons, the tab program management is selected. While on the tab, the (↵) button or the (OK) button is pressed, the program management menu appears. The yellow (●) button is pressed on the channel tab which is intended to be erased, the confirmation menu appears. Using the (OK) button, the erasing process is confirmed or the process is cancelled via the (EXIT) button.

Skipping an Analogue program that has been stored



In the event that you do not wish to come across certain programs while going up and down between channels

using the (↵) buttons, use the following function. Select the program to be skipped by using the (←) or (→) button or Right-left (↵) button. Press the Red (●) coloured button. To the right of the name of the program to be skipped will appear the letter "S" in red. You have the option of applying this method on more than one program channel.

To cancel the program skipping function press the Red (●) button again. red "S" to the right of the program name will disappear, and the skipping will be cancelled. Note: You can still access skipped channels by using the numeric buttons.

001 BBC ONE	11----	S	21----	S
002 BBC TWO	12----	S	22----	S
003 ITV 1	13----	S	23----	S
004 CHANNEL 4	14----	S	24----	S
005 FIVE	15----	S	25----	S
006 ITV 2	16----	S	26----	S
007 BBC THREE	17----	S	27----	S
009 BBC FOUR	18----	S	28----	S
010 ITV 3	19----	S	29----	S
011 SKY THREE	20----	S	30----	S
Skip		Name		
Move		Delete		

To name the Analogue programs

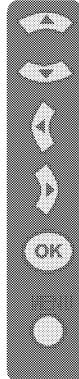

The programs in the table might show the channel names automatically with ATS, but could also show the channel number instead of the name.

You can name any or all of the programs with names that have a maximum of five characters.

Select the program you want to name

using the (←) or (→) or Right-left (↵) buttons. Press the Yellow (●) button. The screen will show the number, volume type and name information for the channel you want to name.





To select a character to use the Right-left (↵) button and use the (←) or (→) buttons to change the character to the desired letter, number or sign. After entering all the letters press the (OK) button to store the name.

To write names for any of the other programs, simply repeat the above procedure. In the event that you wish to exit the application, simply press the (EXIT) button.

If no name is entered for any program, the program number will be automatically displayed.

The setup of your television: Setting up the Sound Menu

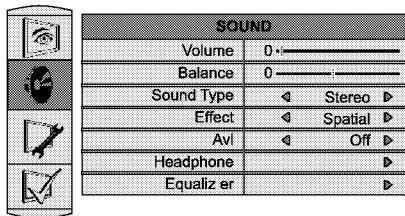

You can set the volume with the Volume buttons on the television or the  buttons on the remote control.

You can control the other sound settings by entering the Sound menu For this application all you need to do is press the  button of your remote control. The sound menu is selected by means of the  or  buttons and the menu is accessed via the  button or the  button. Select the functions from the headings in this menu.





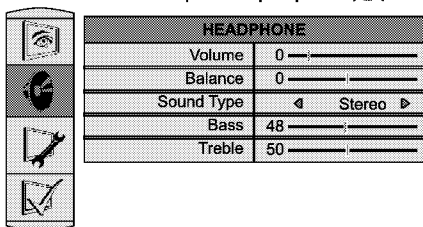

Effect: If you want to add depth to the sound of the program you watch, select Spatial with the  button.

AVL: Television transmitters have different sound levels. This can be noticed from the different volume levels that can be heard while switching from one program to another. Using the right/left movement  buttons switch to on. The AVL (Automatic Volume Limiting) function maintains the same sound level as you switch from program to program. To cancel choose off.

Headphones: By connecting the headphone unit to your television you can listen to the program sounds independently from your television. In order to increase and decrease the sound level of the headphones, you can enter the HEADPHONES menu and make the necessary adjustments using the right/left  buttons in the Volume bar. When you only want to hear the sound from the headphone, just press  button.















Balance: To adjust the volume balance between the left and right headphone to the desired level, select the Balance bar using the down  button. Using the right/left movement /  buttons adjust the balance.

Sound Type: The program you watch might be stereo or in two different languages. Using the right/left keys /  in this menu you can select Mono/Stereo or Dual-A/Dual-B language. Dual-A/Dual-B is not always present with a program broadcast.

Bass: You can adjust the bass levels of the sound you hear in the headphone.

Treble: You can adjust the treble levels of the sound you hear in the headphone. The sound and headphone adjustments made will be stored without any additional transactions necessary.

Equalizer: Selecting the Equalizer mark press  or  button. The equalizer setting function will be displayed. You can select with the right/left /  buttons, pre-programmed, unchangeable equalizer settings. These are Music, Sport, Cinema and Speech. There is also a User setting. To adjust the User setting; select User and press the  button. You can adjust the frequency levels with the  or  buttons. You can select 120Hz, 200Hz, 500Hz, 1.5KHz, 5KHz, 7KHz and 10KHz frequency bands with  and  buttons. To store the adjustment levels in memory press the menu button. You can exit the equalizer function pressing the  button again.

Please note: You can choose the equalizer position directly using the  button of your remote control. You can exit the equalizer function pressing the  button at any time.

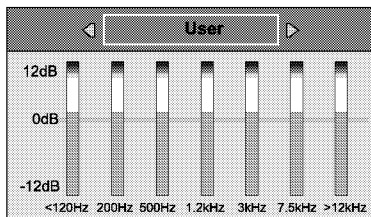

Picture Setup

PICTURE	
Brightness	50
Contrast	30
Colour	50
Sharpness	6
Noise Reduction	◀ Soft ▶
Picture Smart	◀ Soft ▶
Picture Format	◀ Letterbox ▶

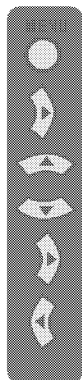

Access picture sub-menu by pressing the **MENU** button on your remote control. Use **Left**/**Right** buttons to select Picture sub-menu and enter by pressing **OK** or **Enter** button. Select the setting function you want using the Up and down buttons **Up** or **Down** and adjust their levels with the right and left **Right**/**Left** buttons.

The picture brightness, contrast, colour and sharpness levels can all be adjusted according to your desire. The changes you make in the picture settings will be automatically stored as your personal settings.

Noise Reduction: Using this feature you can reduce static by selecting off, Soft, Sharpest or Sharp function.

Smart Picture: This is one of the pre-installed and unchangeable features, to select this feature use your **Left**/**Right** buttons. Soft, Natural and Rich are constant values. User are the values you stored into memory. Furthermore, you can select one of the non-adjustable default settings in the memory (Picture Mode) by pressing the **MENU** button on your remote control.

Picture Format: This feature enables you to watch any broadcast image in the format you desire. These are; Auto, 16:9 (no option on sample), Letterbox, 14:9, 4:3, and Zoom. You can do the selection without entering the picture menu by using the **MENU** format selection button.

Colour Tint: When NTSC video is used in SCART, Colour Tint settings can be made. If you do not use such a video type the Colour Tint choice is not seen in the menu. If NTSC video is used in SCART this choice becomes active and can be seen in the menu.

Depending on the type of broadcast being transmitted, programmes can be viewed in a number of formats. Press the **MENU** button repeatedly to select between **Zoom**, **Letterbox**, **Auto**, **16:9**, **14:9**, and **4:3**.

Please note: Whenever the MENU button is pressed the picture size setting will change while the menus are ON the screen. This is to ensure that the menus do not overlap the edges of the viewable area.

Zoom

To fit the screen by stretching the image horizontally, holding the correct proportions at the centre of the image. Some distortion may occur.



Letterbox

Use this setting when watching a widescreen DVD, widescreen video tape or a 16:9 broadcast (when available). Due to the range of widescreen formats (16:9, 14:9, 20:9 etc.) black bars may be visible on the top and bottom of the screen. Letterbox format removes black bars or makes them less visible.



Auto

Some channels may send automatic screen formatting. If you wish to switch automatically to this format select Auto. The TV will automatically switch to the detected format from the scart inputs or broadcast.



16:9

Use this setting when watching a widescreen DVD, widescreen video tape or a 16:9 broadcast (when available). Due to the range of widescreen formats (16:9, 14:9, 20:9 etc.) black bars may be visible on the top and bottom of the screen.



14:9

This is the movie format.



4:3

Use this setting to view a 4:3 broadcast.



Using the special functions to change the size of the displayed image (i.e. changing the height/width ratio) for the purposes of public display or commercial gain may infringe on copyright laws.

Features Menu (Analogue)

FEATURE	
On/Off Timer	▷
Menu Language	▷
Scart2 Output	◀ Scart 1 ▷
Teletext	◀ Auto ▷
Panel Lock	◀ Off ▷

MENU LANGUAGE	
English	Enoki
Deutsch	Dansk
Français	Deutsch
Italiano	Suomi
Español	Polski
Português	Ελληνικά
Türkçe	Pracovni
Svenska	Slovensčina
Češky	Magyar
Hrvatski	Српски
Română	Български
Slovensko	



The Feature menu is accessed via the menu button. The feature menu is selected by using the up-down buttons and use the (OK) button or the Right side button, to enter.

You can select the headings you want to adjust in this menu by using the (◀)/ (▶) buttons.

Features Menu (Digital)

The Feature menu is accessed via the menu button. The feature menu is selected by using the up-down buttons and use the OK button or the Right side button, to enter. You can select the headings you want to adjust in this menu by using the (◀) or (▶) buttons.

FEATURE	
Digital Features	▷
On/Off Timer	▷
Menu Language	▷
VCR Mode	◀ Off ▷
Scart2 Output	◀ Scart 1 ▷
Teletext	◀ Auto ▷
Panel Lock	◀ Off ▷

DIGITAL FEATURES	
Time	A
Default Audio Language	◀ English ▷
Default Subtitle Language	◀ English ▷
Parental Control	◀ Off ▷
Common Interface	No Module ▷
Software Upgrade	▷
MENU: Back *EXIT*: Watch TV	

Panel Lock: If you switch this feature On, the buttons on the TV (except on/off) will not work when the TV is in Stand-by mode or on.

Language: Select the menu language line and press (OK) or the right (▶) button. The screen will show the menu languages. Select the desired language using the Up-down (◀) or (▶) and Right-left (◀/▶) buttons. Press the (OK) button again. Your television will now feature the language you have chosen for all the adjustment indicators and menus.

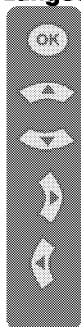

Scart2 output: This features enables you to select the video and audio output source to your recording equipment.

Either connect the scart input of recording device to the TV's Scart1 source (marked AV1 on the unit and select Scart 1 in Scart2 output option. Or connect the AV (PHONO) Input of recording device to the TV's AV out (PHONO) connection and select AV in Scart2 output option. Connect the output of your recording device as you find appropriate from connecting external equipment chapter.

To record from the output set recorder to record from its correct input source, you may need to refer to recording devices User manual. The recording device will record what analogue or digital channel you are viewing. Note that if you attempt to view output of recording device while the recording devices is set to the input source from the tv you will probably experience interference on your TV screen.

Note: If pip mode is active while recording, the window selected will be recorded. If you select the other PIP window (using up/down buttons) during record the output is automatically switched.



On/Off Timer: Your television features an automatic stand-by feature which can be enabled for any time period up to 12 hours and 59 mins by using the numeric buttons. If you want your television to automatically go into stand-by, please select the off timer line. Select the desired duration with the Right (▶) and left (◀) button.

At the end of the chosen duration the screen will show a 30 second countdown before switching off the screen and entering into stand-by. To cancel the automatic stand-by; set off timer to 00:00.

The setup menu is opened via the menu button. The feature title is selected by means of the up-down button. Using the (OK) button or the (▶) button, the feature menu is accessed. The On/off timer tab is selected and its menu is opened via the right button. In the Off-timer tab, the sleep time is set via the right-left side buttons and the time to elapse until it restarts after being turned off is set on the On-timer tab. In the On-timer list title, it is decided whether the power-on will be done by the digital TV or the analogue TV.

VCR mode(Digital): Using this feature you can avoid image distortions from the device or the magnetic tape while watching. For this you have to switch the VCR mode to ON.

FEATURE		
	Digital Features	▶
	On/Off Timer	▶
	Menu Language	▶
	VCR Mode	◀ Off ▶
	Scart2 Output	◀ Scart 1 ▶
	Teletext	◀ Auto ▶
	Panel Lock	◀ Off ▶

Please note: This feature is only active for the AV inputs. This option will not be seen in Feature menu while watching programs or in PC mode. This feature becomes automatically active in the "0" numbered program. When you store the "0" numbered channel as video device aerial output, you will be able to avoid image distortions from the device or the magnetic tape while watching.

PIP Usage (Picture in Picture) Feature:

Press the button on your remote control. The screen will show the PIP window selection menu.



In this menu use / buttons to select either Picture in Picture (PIP) or Divided Screen (PAP) and press the button.

According to the selection a picture will open in main picture or two pictures side by side.

If you choose Full Screen mode PIP will be disabled. In the event that you wish to exit PIP mode, simply press the button and select the full screen icon.

When PIP or PAP feature is selected you can activate the main picture or the secondary picture by pressing up and down navigation buttons. The active picture is expressed with a white border. The menu features can be used for the active picture. With the AV button you can choose also the sources at the active window during PIP or PAP feature is on

Note:

- 1) To change a channel or source a PIP window is displaying:
 - a) Select the window to change using up/down buttons.
 - b) Use remote control to change channels or source as you would in normal full screen mode.
- 2) You can use PIP in PC or DVI mode.
- 3) The same source cannot be watched with PIP and the main image.

PIP Position

This feature enables you to position your PIP window. For this press the button, while PIP mode is active, to bring the PIP Position menu on screen.

Press the right/left / buttons to select the PIP Position desired. After you have positioned your PIP window you can exit the menu by pressing the button on the remote control.

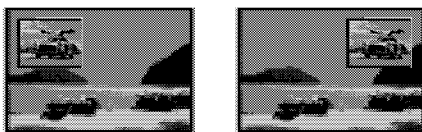

PIP Size

This feature enables you to resize your PIP window. For this press the button, while PIP mode is active, to bring the PIP Size menu on screen.

Press the right/left / buttons to change the PIP Size. After resizing your PIP window you can exit the menu by pressing the button on the remote control.

PAT Mode

The pat (picture and text) feature is opened by pressing the button and then pressing the button while in the TEXT mode. This feature ensures that both the teletext and the channel intended to be watched can be shown on the screen simultaneously. To exit the pat mode, the PIP button is pressed.

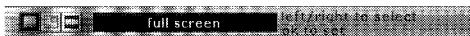

Digital TV Menu:

Digital TV menu also consists of the following menus as in the Analogue TV menu:

1. PICTURE
2. SOUND
3. SETUP
4. FEATURE

Here, the only difference is the "Digital Features" option located under the "FEATURE" Menu. Please see the following picture:

	FEATURE
	Digital Features ▶
	On/Off Timer ▶
	Menu Language ▶
	VCR Mode ◀ Off ▶
	Scart2 Output ◀ Scart 1 ▶
	Teletext ◀ Auto ▶
	Panel Lock ◀ Off ▶

On the picture below, you can see the sub-menus located under the option "Digital Features".

To enter Digital Features select Digital feature using the up/down buttons and press OK to enter.

1. Timer Menu:

By setting the timer in the Timer menu the TV can be set to automatically switch to another channel at a specific time. To enter Timer select timer using the up/down buttons and press right button. After a short delay the timer menu will appear. Press the red button to enter a new timer. Set timer menu is displayed after a short delay. The settings of date, starting time, ending time, repeating function, subtitle and audio language for the timer are made using the or or and numeric buttons. When complete Press OK to save the event.

When the set time and hour arrives, a pop-up menu appears on the screen to prompt the user whether they would like to be switched to the specified channel or not. Channel switching is enabled via the button or the timer is cancelled using the button.

	DIGITAL FEATURES
	Timer ▶
	Default Audio Language ◀ English ▶
	Default Subtitle Language ◀ English ▶
	Parental Control ▶
	Common Interface No Module ▶
	Software Upgrade ▶
	"MENU": Back "EXIT": Watch TV

2. Default Audio Language Option:

This setting ensures that the default language will be audible when it is available with a broadcast. Selection is made among languages using the keys.

3. Default Subtitle Language Option:

Set the default language desired. If subtitle option is activated and the default language is available with the broadcast you are watching subtitles will automatically be displayed in this language. Selection is made among languages using the right/left arrow keys.

4. Parental Control Menu:

Using this menu, the adult user determines a password with the buttons 0-9 and is able to prevent access to the channels they determine from among the 'Program Management' menu. When it is intended to switch to the blocked channel, the password is prompted.

Besides, it is also activated so that the features like timer, auto search, manual search, program management found in the menu are not changed.

At the beginning the pin is "1982". After you enter the pin, the Parental Control Menu with the Change pin option appears. You can change the pin by using this menu

PARENTAL CONTROL	
Current PIN	- - - -
0-9: to enter pin "MENU": Back "EXIT": Watch TV	

PARENTAL CONTROL	
Parental Lock	◀ Off ▶
Change PIN	
"MENU": Back "EXIT": Watch TV	

5. Common Interface Menu:

When the CI module is inserted in order to be able to watch encoded channels, the inserted module is viewed in the 'Common Interface' menu. It is possible to access from this option the information related to the module. Top up TV feature is supported.

6. Software Upgrade Menu:

The possibility for uploading new software is ensured via the Software Upgrade menu. Menu adjustments can be done using the right/left arrow buttons. If new software data is being sent along with the broadcast, new software can be downloaded via this menu option.

Software updates can be performed automatically or manually as desired.

When the Auto Upgrade is selected "ON" if there is a new SW, there will be upgrade every time the TV passes through stand-by mode.

To receive the new software version, your TV must be in standby mode.

SOFTWARE UP GRADUATE	
Version	1.3.1.3
Auto Upgrade	◀ Off ▶
Search for New Software	▶
"MENU": Back "EXIT": Watch TV	

Using Teletext

Teletext is an information system that displays text on your TV screen. Using the teletext control buttons you can view pages of information that are listed in the teletext index.

Please Note

No on screen display is available in text mode. The contrast, brightness and colour cannot be changed but the volume control is still available.

To enter Text mode

Please Note

Make sure the TV channel you are watching transmits teletext.



Press the  button. The text page will appear, normally the index page.

To exit Text mode





Press the  button. The screen will return to the channel you were watching.

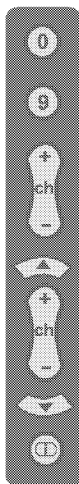

To select a page of text



Find the number of the page in the index and enter it using the Numeric buttons. The number of the page will appear in the top left hand corner of the screen.

The page counter will search for your page. When it finds it, the page will be displayed.

To move to the next page of text press the  /  button.

To move to the previous page press the  /  button.

To return to the index page press the  button.

TV/Text mix



To view a TV programme whilst in text mode, press the  button. The text will be superimposed over the TV programme.

Press the  button again to return to the TV programme.

Page search whilst watching TV

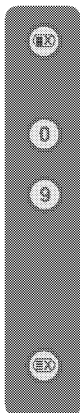

In Text mode press the  button. The TV will return to TV mode with the text page number in the top left hand corner of the screen.

Enter the page number you want using the Numeric buttons.

The top line of the text page will appear whilst the text searches for your page. When the page is found the number will remain in the top left hand corner of the screen.

Press the  button to view your selected page of text.

Double height text



If you have difficulty reading the text on the TV you can double the height of the text.

Press the  button. The top half of the page will be displayed in double height text.

Press the  button again. The bottom half of the page will be displayed in double height text.

Press the  button again to return to the full page.

Page Stop

If the page of text you have selected contains sub pages, these sub pages will automatically be displayed in order with a delay to allow you to read the page.



To stop the move to the next sub page press the (■) button.



To continue moving through the sub pages press the (■) button again.

To select a sub page



If the page of text you are viewing contains sub pages, the number of the sub page you are on and the total number of sub pages is displayed on the right of the screen i.e. 1/7.



To select a sub-page press the (■) button. Press the UP button or CH+ button to select next sub-page and press the DOWN button or CH- button to select the previous sub-page.



Enter the number of the sub page, using the Numeric buttons in the format SOT for sub page 1.



To reveal information



Press the (■) button to reveal concealed information (quiz answers etc.).



Press the (■) button again to cancel the information again.

Clock



Press the (■) button, while watching a TV program, to display the time.
Note: This is only operational for analogue source channels that also receive teletext.

Fastext

At the bottom of the teletext screen is a row of subject headings in red, green yellow and blue.

The remote control has a row of coloured buttons corresponding to the row of coloured subjects on the screen.

Pressing one of the coloured buttons will take you directly to the page corresponding to the subject heading.

Teletext characters are decoded according to the languages of the countries chosen before Auto program. For correct decoding and showing of the teletext characters, the auto-program should be carried out by selecting your country from the pop up menu for Country selection before tuning.

Digital Teletext

Viewing a digital text service

Digital TV channels broadcast high quality digital teletext for their subscribers including graphics and text. The content and navigation within the digital teletext is defined by the broadcaster.

Selecting digital text from channels

Digital teletext services are indicated sometimes by a symbol appearing on screen. To enter the digital teletext, press the RED or TEXT button on your remote control. After having entered the digital teletext, the on-screen instructions direct one to the desired sub-pages. The navigation inside the digital teletext may be performed using the arrows, colors, numbers and OK/SELECT buttons on the remote control. Having finished to view the digital teletext, one may leave it by pressing either the RED or the TEXT button on the remote control

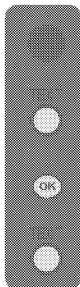

Note: You cannot view digital text when subtitles are enabled.

Connecting external equipment

AV Inputs:

Press the (◆) button on your remote control. You will enter the Source menu from where you can select the screen input mode. Here select the input you desire.

TV: To move to TV mode while in AV modes, select Analogue and press the (OK).

Scart1: To be able to view the broadcasting images from the device connected to Scart1, select Scart1 and press the (OK) button. (If the connected device has an RGB output, you will be able to watch it over Scart.)

Scart2: To be able to view the broadcasting images from the device connected to Scart2, select Scart2 and press the (OK) button. (If the connected device has an RGB output, you will be able to watch it over Scart.)

SVHS: To be able to view the images from the device connected to the S-Video input, select S-Video and press the (OK) button.

AV: To be able to view the images from the device connected to the PHONO input, move on to the selection and press the (OK) button.

PC: To be able to view monitor images in PC mode, move on to the selection and press the (OK) button.

SOURCE Menu: Pres the AV key of the remote control. The SOURCE menu which is shown below appears on the screen. From this menu, switching to the "Analogue TV" "Digital TV" "PC" is possible. You may select the modes "Scart1" "Scart2" "S-Video" "AV" "HDMI" "YPbPr".

HDMI Option: HDMI (High-Definition Multimedia Interface) is a digital video and audio standard which can transmit the uncompressed digital video as well as audio together and has been acknowledged throughout the world marking a first and only example of its kind available. You can connect by means of a single cable any HDMI supported video or audio source (STB, DVD player, A/V receiver) and any monitor or television that is HDMI supported. Using HDMI, you may watch High definition video in addition to being able to listen to the digital audio of up to 8 channels using a single cable.

From HDMI input, High-bandwidth Digital Content Protection (HDCP) is supported.

Connecting a video recorder/DVD recorder or Decoder

① Via SCART

Make sure the TV and video recorder are both switched off.

Plug one end of the SCART lead (not supplied) into the back of the video recorder and the other end into one of the SCART sockets on the back of the TV. Connect aerial to the RF/aerial input at the rear of your recording/decoding device. Connect RF/Aerial out socket of your recording/decoding device to the TV's aerial input.

Switch on the video recorder and the TV.

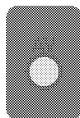

Press the (SCART) button on the remote control to select SCART1, SCART2 to correspond with the SCART socket you are using on the back of the TV.

Please note: You can connect RGB external equipment via Scart.

Select the video output of the external device by using its menu, and set to RGB.

② Via PHONO lead

Make sure the TV and video recorder are both switched off.

Plug one end of the PHONO lead into the video and audio out sockets on the back of the video recorder and plug the other end into the video and audio in sockets of the TV.

If the sound is mono, use the Audio Input L. and in the SOUND menu select the MONO feature. Connect aerial to the RF/aerial input at the rear of your recording/decoding device. Connect RF/Aerial out socket of your recording/decoding device to the TV's aerial input.

SOURCE
Analogue TV
Digital TV
Scart 1
Scart 2
S-video
AV
PC
HDMI
YPbPr
OK: SELECT

③ Via aerial socket (Video recorder only)

Make sure the TV and video recorder are both switched off.

Unplug the aerial lead from the TV and plug it into the aerial socket on the video recorder.

Plug a coaxial plug into the RF out socket on the rear of the video recorder and plug the other end into the aerial socket on the TV. Switch on the video recorder and the TV. If your video recorder has a test signal, switch it on. (Refer to the video recorder user guide). Alternatively play a pre-recorded tape as a substitute.

See 'Tuning the TV' and carry out the tuning procedure for the video recorder test signal. Select a programme number 0.

④-5 Via PHONO lead and S-Video socket

You can also connect it through the S-Video socket of the TV.

Plug the S-Video plug into the S-Video socket and the audio leads into the audio sockets.

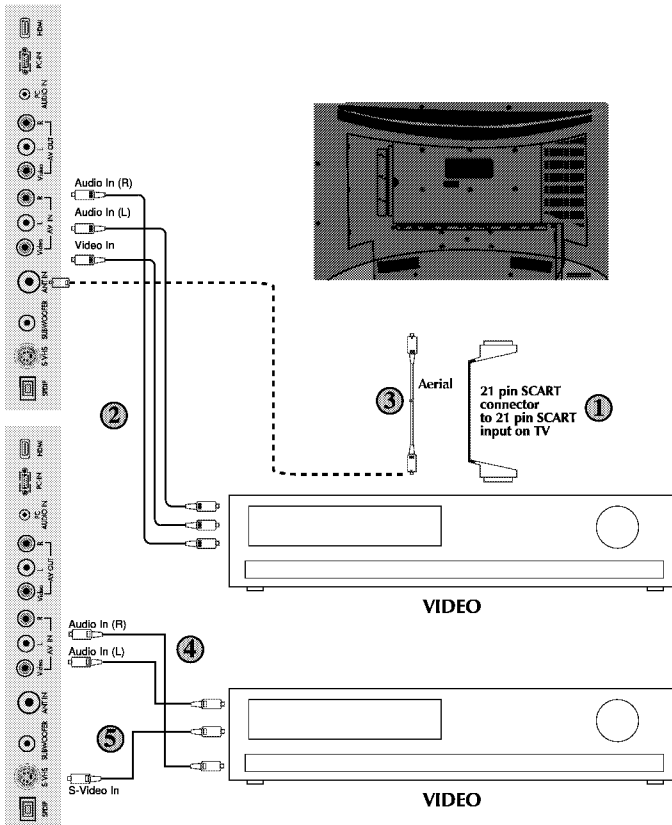

Connecting a DVD/Video player

DVD/Video Diagram

① Via SCART

Make sure the TV and DVD player are both switched off.

Plug one end of the SCART lead (not supplied) into the back of the DVD player and the other end into the SCART socket on the back of the TV.

Switch on the DVD and the TV.

② Via PHONO lead

Make sure the TV and DVD player are both switched off.

Plug one end of the PHONO lead into the video and audio out sockets on the back of the DVD player and plug the other end into the video and audio in sockets of the TV.

③ Via PHONO lead and S-Video socket

You can also connect it through the S-Video socket of the TV.

Plug the S-Video plug into the S-Video socket and the audio leads into the audio sockets.

AV Outputs

You can connect any device which has Phono Video and Audio Out Connectors to the back of your TV set using correct AV cable (not available with the set).

The current view from tuner or AV input seen on the main screen except S-VHS, PC or DVI (which is optional) is available as picture and sound signals at Phono Video/Audio outs.

Scart sockets at the back of your TV always give the signals of selected programme from the set Tuner. For further information see Scart2 output on page 18.

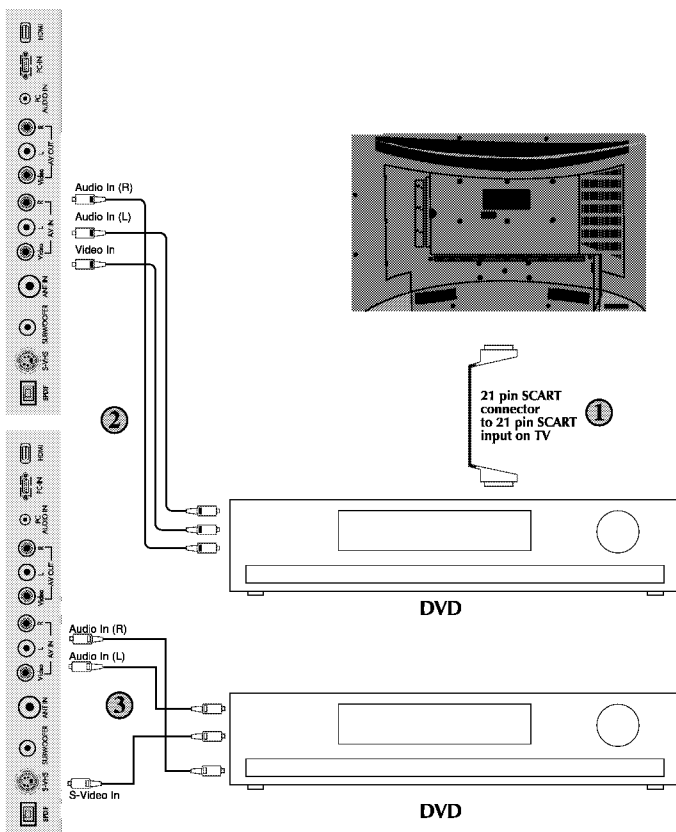





INTRODUCTION

Because your LCD-TV equipment is provided with VGA inputs, it may be used as a PC monitor as well. (Plug&Play)







Connecting PC:

Connect your PC through the D-Sub connector and an appropriate cable (not included with your TV) to PC-IN input the back of the TV. Again using an appropriate cable you can connect your PC sound output to the AUDIO IN input on the back of the TV and listen to sound.

Transition to the PC mode

In order for the LCD-TV to switch to the monitor (PC) mode, you can press the  button on your remote control and by using the   buttons, you must select PC and then press . In order to switch from the PC mode back to the TV mode, use the  button on your remote control.

PC Input Settings

You can enter the picture setting menu by pressing the  then  while in PC mode. In order to make the necessary adjustments in this menu, you can use the right-left, up-down direction  ,  or  buttons on your remote

control to alter brightness and contrast as well as other adjustments for the monitor listed below.

H.Position: Horizontal position setting

V.Position: Vertical position setting



PHASE: Using the Right/left  or  buttons you can adjust colour and shape.

Picture Format: You can select the PC image in the 16:9, 4:3 or 1:1 formats.

You can make your choices without entering the picture menu by using the format button on your remote control.

Automatic Position: The most suitable geometric settings in accordance to the entry mode is configured by this function. For this application, choice the AUTO Position option and press the  button.

In PC mode you are able to use PIP as mentioned in the sections above.

You can adjust the volume of the device you connect to the Audio-In input at the back of the TV by using the  or  buttons.

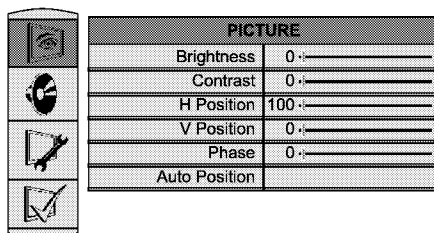

In PC mode, HDMI and YUV modes can't be displayed (PC-HDMI, PC-YUV) for PIP function.

Connecting TV with video and satellite/digital receiver

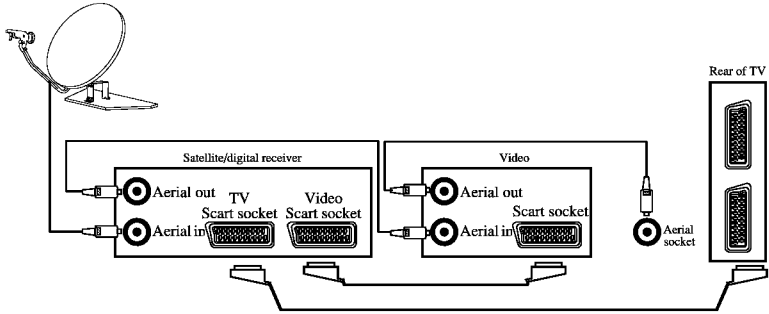

Connecting TV with camcorder

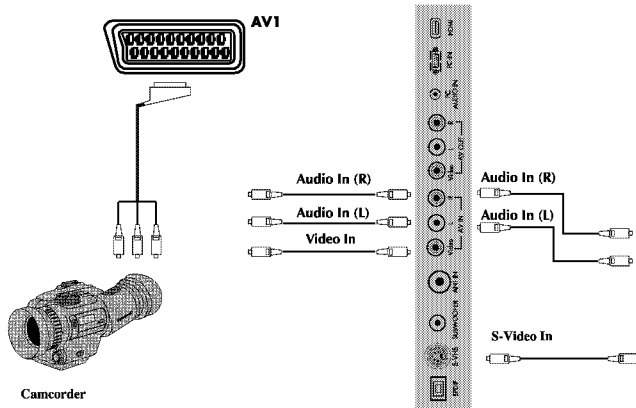

Connecting TV games and computer

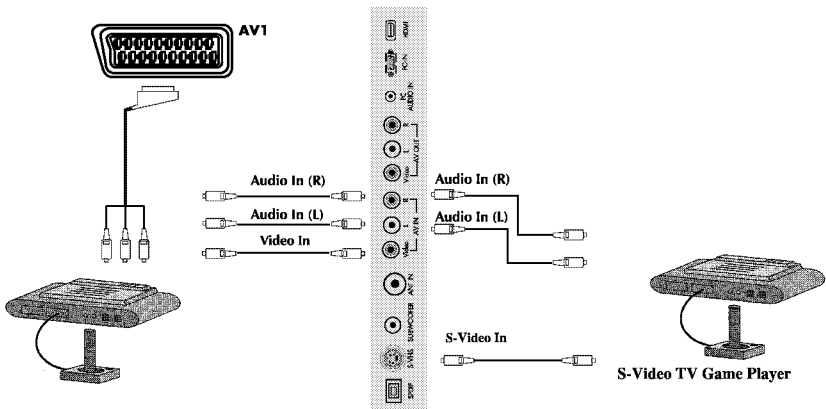

Help and service tips

The TV does not work

Make sure it is plugged into the mains supply and switched on.

Poor picture

- Is the aerial plugged in?
- If you are using a set top aerial is it properly aligned for the best signal.
- Make sure the aerial is not too close to neon lights, loudspeakers etc.
- Try changing the direction of the outdoor aerial. High buildings and mountains can cause ghost pictures or double images.
- The picture quality may be reduced by connecting two external sources at once. Disconnect one of the sources.
- Adjust the fine tuning.

No picture (TV)

- Is the aerial plugged in properly.
- Is the aerial lead damaged.
- Are all the plugs in the aerial lead fitted correctly.
- Have you pressed the correct buttons on the remote control.

No picture (PC)

- Is the VGA lead connected correctly.
- Is the PC switched on.

Small picture (TV)

- A black band may be present top and bottom of the picture dependant on the broadcast this is not a fault.

No sound

- Is the sound muted? Press the Mute button.
- Is the volume turned down?
- Are there headphones connected?
- Is the tv set to the correct system(see tuning).

Sound coming from only one speaker

- Is the balance set to one side. See the sound menu.
- If you have external speakers, has one of them become disconnected.

No response to the remote control

- Try changing the batteries.
- Is there an obstruction between the remote control and the sensor on the TV.
- Is the function required relevant to source selected or mode you are in (i.e Teletext)

No TV listings or incomplete TV listings

- The TV needs to powered on overnight for TV listings to be downloaded.

Cannot switch to a Non-Favourite channel

- Press "FAV" button on your remote control and select "ALL" from the osd screen on the TV.

If nothing works

If you have tried the above solutions and none seem to work, try switching the unit off and on again.

If this does not work contact your supplier or TV repair technician. Never attempt to repair a defective TV yourself.

Symptoms	Solutions	Check if on/off switch is "on"	Try a different channel. If OK, probably station trouble	Check aerial connections on back of set	Check aerial broken wires	Re orientate aerial	Probably local interference, such as an appliance	Adjust fine tuning control	Adjust brightness control	Adjust contrast control	Check if station is broadcasting colour	Adjust colour control	Check batteries in the remote control handset	Switch the TV set OFF and ON from mains
No picture, no sound		✓	✓	✓	✓	✓	✓	✓	✓	✓	✓	✓	✓	✓
Poor sound, picture OK		✓	✓	✓	✓	✓	✓	✓	✓	✓	✓	✓	✓	✓
Poor Picture, sound OK		✓	✓	✓	✓	✓	✓	✓	✓	✓	✓	✓	✓	✓
Weak picture		✓	✓	✓	✓	✓	✓	✓	✓	✓	✓	✓	✓	✓
Blurred picture		✓	✓	✓	✓	✓	✓	✓	✓	✓	✓	✓	✓	✓
Double image		✓	✓	✓	✓	✓	✓	✓	✓	✓	✓	✓	✓	✓
Lines in picture		✓	✓	✓	✓	✓	✓	✓	✓	✓	✓	✓	✓	✓
Distorted picture		✓	✓	✓	✓	✓	✓	✓	✓	✓	✓	✓	✓	✓
Weak reception on some channels		✓	✓	✓	✓	✓	✓	✓	✓	✓	✓	✓	✓	✓
Horizontal bars		✓	✓	✓	✓	✓	✓	✓	✓	✓	✓	✓	✓	✓
Picture rolls vertically		✓	✓	✓	✓	✓	✓	✓	✓	✓	✓	✓	✓	✓
Poor colour		✓	✓	✓	✓	✓	✓	✓	✓	✓	✓	✓	✓	✓
No colour		✓	✓	✓	✓	✓	✓	✓	✓	✓	✓	✓	✓	✓
Remote control not working		✓	✓	✓	✓	✓	✓	✓	✓	✓	✓	✓	✓	✓
TV does not accept any command		✓	✓	✓	✓	✓	✓	✓	✓	✓	✓	✓	✓	✓
Teletext rolling up/down		✓	✓	✓	✓	✓	✓	✓	✓	✓	✓	✓	✓	✓

Technical specifications table

LCD Panel size/type	26" 16:9 active matrix TFT
Sound Output (%10 THD)	2x7 W
Power consumption	125 W
Stand by Power consumption	6 W

General technical specifications

Power Supply

AC: 230 V 50 Hz

Number of preset programmes.....100

RF Aerial input75 ohm (unbalanced)

Sound SystemsMono/Stereo/NICAM

Batteries2x UM-4, IEC R03 or AAA 1.5V

Receiving channelsVHF (Band I Channels 2-4)

.....VHF (Band III Channels 5-12)

.....UHF (Channels 21-69)

.....Cable TV (S1-S20/S21-S41)

Receiving broadcast systemDVB-T Freeview

PAL BG

PAL SECAM BG

PAL SECAM BG DK/DK'

PAL SECAM BG LL'

PAL I

Please note: Your TV set is produced to receive only "one" of this colour and sound system options which is based on your countries norms and can not be changed by user except BG/DK and BG/LL' if both systems are available to receive (BG or DK and BG or LL'). Please refer to "Tuning the TV". Note for U.K, broadcasts use PAL I.

NOTE:

This is a Class A product. During operation the device can cause radio interference. In this case the user may have to remedy this. Please contact your specialist dealer.



Environmental note

This product has been made from high-quality parts and materials which can be re-used and recycled.

Therefore, do not throw the product away with normal household waste at the end of its life. Take it to a collection point for devices. This is indicated by this symbol on the product, in the operating manual and on the packaging.

Please find out about collection points operated by your local authority. Help protect the environment by recycling used products.

MAIN UK TRANSMITTER STATIONS

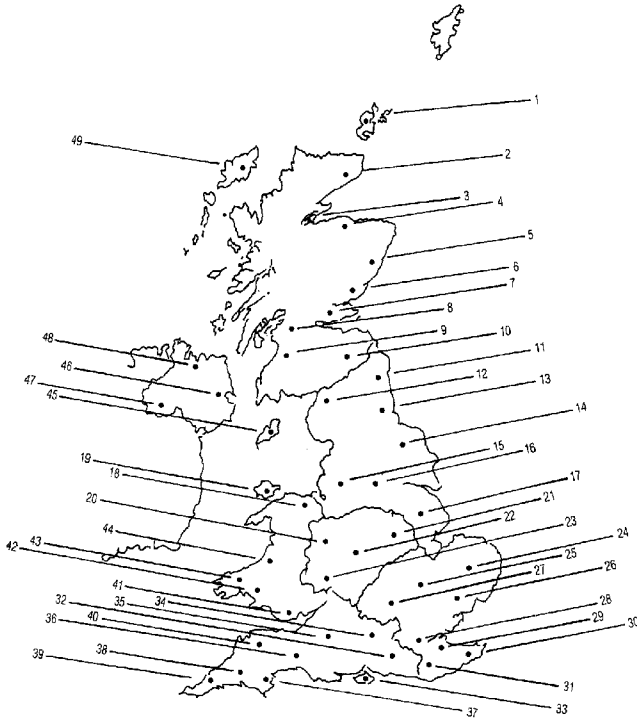

UHF CHANNELS

Regional Main Stations

	BBC1	BBC2	ITV	CH4	CH5	Map
North West						
Cardale	30	34	28	32	56	12
Winter Hill	55	62	59	65	48	15
Doogies (IOM)	68	66	48	56	56	45
North						
Belmont	22	28	25	32	56	17
Embsay Moor	44	51	47	41	37	16
North East						
Bilsdale West Moor	33	26	29	23	35	14
Charbon	39	45	49	42	11	11
Rentop Pike	38	64	61	54	56/68	13
Midlands (West)						
Ridge Hill	22	28	25	32	35	23
Sutton Coldfield	46	49	43	50	37	22
The Wreccin	26	33	23	29	25	20
Midlands (East)						
Waltham	58	64	61	54	35	21
South West						
Beacon Hill	57	63	60	53		37
Caradon Hill	22	28	25	32	38	38
Hunkshaw Cross	55	62	59	65	67	40
Rodruith	51	44	41	47	37	39
Speckland Hill	33	26	23	29		36
Channel Islands						
Tranent Point	51	44	41	47		
West						
Mendip	58	64	61	54	37	35
South						
Hamington	39	45	42	66	35	34
Midhurst	61	55	58	68		32
Rowbridge	31	24	27	21		33

STATIONS CT D

	BBC1	BBC2	ITV	CH4	CH5	Map
Bluebell Hill	40	46	43	65		29
Crystal Palace	26	33	23	30	37	28
Dover	50	56	66	53		30
Heathfield	49	52	64	67		31
Oxford	57	63	60	53	49	27
East						
Sandy Heath	31	27	24	21		39
Sudbury	51	44	41	47		35
Tacolneston	62	55	59	65		24
Scotland						
Angus	57	63	60	53		6
Black Hill	40	46	43	50		37
Craigkelly	31	27	24	21		48
Darvel	33	26	23	29		7
Dunnis	22	28	25	32		67
Eilshol (Lewis)	33	26	23	29		49
Keaylong Hill	40	46	43	50		1
Knock More	31	27	24	21		2
Rossmarie	39	45	49	42		3
Rumster Forest	31	27	24	21		2
Salford	55	62	59	65	52	10
Wales						
Blaenpiwyl	31	27	24	21	56	44
Carmel	57	63	60	53		42
Llanddona	57	63	60	53		19
Mael-y-Parc	52	45	49	42		16
Prasey	46	40	43	50	37	43
Wanoe	44	51	41	47		41
N.IRELAND						
Brougher Mountain	22	28	25	32	37	47
Divis	31	27	24	21	31	46
Limavady	55	62	59	65		48



Guarantee - Television

Your new television is guaranteed against the cost of breakdown repairs for twelve months from the date of the original purchase. (* see note below for small screen sets)

What is covered?

- All repairs necessary as a result of faulty materials, defective components or manufacturing defect.
- The cost of all functional replacement parts, excluding remote control batteries
- The labour costs of a Beko approved repairer to carry out the repair.
- (*) For TV's with screen sizes of 21 inches or less (measured diagonally corner to corner) you may be offered a replacement instead of repair under guarantee. Your dealer will advise you.

What is not covered?

- Transit or delivery damage
- Accidental damage
- Misuse, or abuse.
- Cabinet or appearance parts, including knobs and flaps
- Remote control batteries.
- Repairs or replacements required as a result of unauthorised repairs or inexperienced installation that fails to meet the requirements contained in the user instruction book.
- Repairs or replacements to product installed or used on commercial or non-household premises.

Important notes.

- The product is guaranteed for domestic household use only.
- The guarantee will be void if the product is installed or used in commercial or non-household premises.
- The product must be correctly installed and operated in accordance with the instructions contained within the Operating Instructions Booklet provided with the product
- The guarantee is given only within the boundaries of the United Kingdom and the Republic of Ireland.
- The guarantee is not transferable if the product is resold.
- Beko Plc disclaims any liability for incidental or consequential damages.
- The guarantee does not in anyway diminish your statutory or legal rights.

Beko House, Caxton Way, Watford, Herts, WD18 8UF, Tel: 0870 774 10 50



HOW TO OBTAIN SERVICE

Congratulations on your choice of a Beko colour television. Your new television has been designed and manufactured to the highest quality standards to give you many years of use. To get the best out of it, please take a few moments to read the instruction book.

Your television is supplied with a full 12 months guarantee, covering parts and labour. Should you require service under guarantee, simply call the number below (***)see note for small screen sets)

0870 774 10 50

Our service receptionist will ask you for your product model number, your retailer's name, and the date of purchase when you call. It will assist you if you complete the box at the bottom of this page when you take delivery of your television so that the information is readily available should you need it. If it is necessary for an engineer to visit your home he will normally be there within 48hrs of receipt of your call (excluding Bank Holidays) or at your earliest convenience.

Before telephoning for service please check the trouble shooting guide in the instruction book as often minor problems are easily identified and resolved by following the instructions contained therein. Service visits where there is no fault with the product could incur a charge even though the product is under guarantee.

Service is also available on the above number after the guarantee period has expired. The cost of any repairs outside of the guarantee period is payable to the engineer at the time of visit .

Please complete the box below for ease of reference later.

Model Number	Serial Number
Date of Purchase	Place of Purchase
Please keep your purchase receipt. The engineer will need to see it should you require service under the 12-month Guarantee.	

***** Special Note:**

In home repair service is not available on models with a screen size of 21" or under. You should contact your retailer for advice and assistance on these models.

