



LCD TV 32"

MODEL LCD3227A-2

User's Manual

Contents

Caution	2
Main Unit Descriptions	3
Accessories	5
Getting Started	5
Remote Control Key Functions	6
TV Operation	8
Select Input Source	8
Basic Operation	8
Picture Menu	9
Sound Menu	11
Channel Menu	12
Parental Control	13
Setup Menu	15
Others Menu	17
Wall Mount Install Ation	18
Specifications	19
Simple Troubleshooting	19

Caution



The lightning flash with arrowhead symbol, within an equilateral triangle is intended to alert the user to the presence of un-insulated " dangerous voltage " within the products enclosure that may be of sufficient magnitude to constitute a risk of electronic shock to the persons.



The exclamation point within an equilateral triangle is intend to alert the user to the presence of important operating and maintenance (servicing).

Safety Information

To ensure reliable and safe operation of this equipment, please read carefully all the instructions in this user guide, especially the safety information below.

Electrical safety

The TV set should only be connected to a mains supply which matches that stated on the label on the rear of the product. To prevent overload, don't share the same mains supply socket with too many other items of equipment.

Do not place any connecting wires where they may be stepped on or tripped over.

Do not place heavy items, which may damage the leads, on them.

Hold the Mains plug, not the wires, when removing from a socket.

During a thunderstorm or while leaving the TV for long periods, disconnect the aerial (if outdoor) and mains from the supply.

Do not allow water or moisture to enter the TV or mains adaptor. Do NOT use in wet or moist areas such as Bathrooms, steamy kitchens or near swimming pools.

Pull the plug out immediately, and seek professional help if:

The mains plug or cable is damaged

Liquid is spilt onto the set, or if it is accidentally exposed to water or moisture

Anything accidentally penetrates the ventilation slots

The set doesn't work normally

Do not remove the safety covers. There are no user serviceable parts inside.

You may invalidate the warranty. Qualified personnel must only service this apparatus.

To avoid battery leakage, remove exhausted batteries from the remote control handset, or when not using for a long period.

Physical safety

Do not block ventilation slots in the back cover. You may place the TV in a cabinet, but ensure at least 5cm (2") clearance all around.

Do not tap or shake the TV screen, you may damage the internal circuits. Take good care of the remote control, do not drop.

To clean the TV use a soft dry cloth. Do NOT use solvents or petrol based fluids.

For stubborn stains, you may use a damp soft cloth with dilute detergent.

Main Unit Descriptions

● FRONT

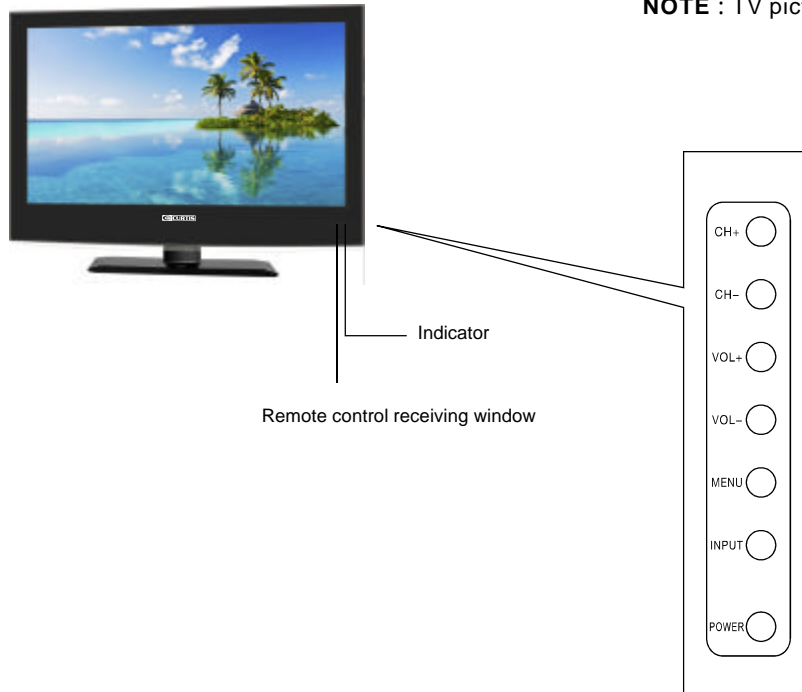

NOTE : TV picture is for reference only.

The functions of the buttons are described as bellows:

CH+/-: Press to choose UP/DOWN channels.

VOL+/-: Press to adjust the volume.

MENU: Press to display the OSD menu, Press again to exit the menu.

INPUT: Press to select the input source.

POWER: Turn on and off, carry out the function of standby and turn-on.

NOTE :

The effective receiving scope for the signal is 5-8 meters from the front of the remote control window, and 30degree to the left or right side and 20degree above or below the control window.

To operate the LCD TV, you must point the remote control sensor of the TV (Objects placed between them may affect the operation). Never let the remote control sensor on the TV becomes exposed to the direct sunlight or strong light.

Main Unit Descriptions

● INPUT AND OUTPUT TERMINAL

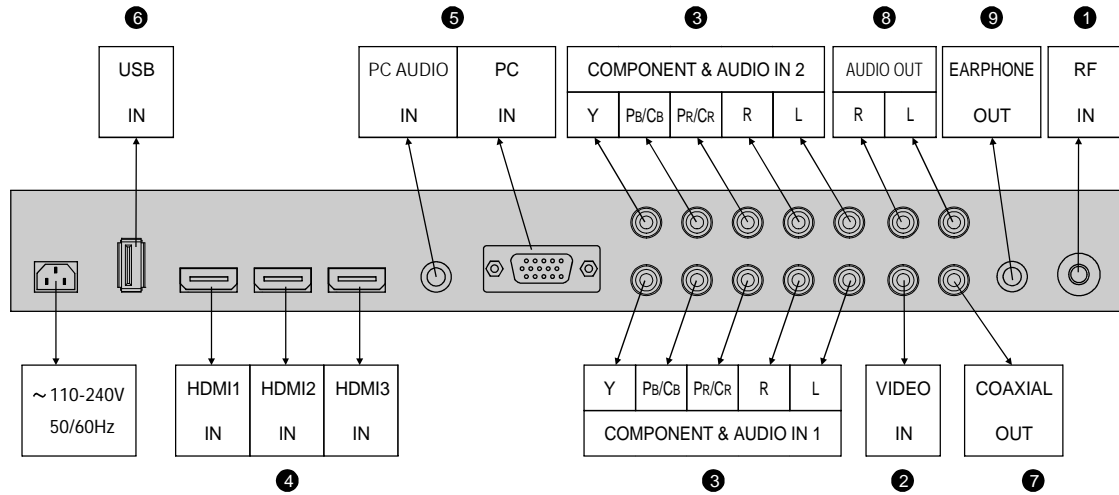

- ① 75 ohm Antenna Socket.
- ② Video signal receivable. (AUDIO from YCbCr/YPbPr1)
- ③ YCbCr/YPbPr component signal receivable.
- ④ HDMI Input.
- ⑤ PC analog RGB signal receivable.
- ⑥ USB Input. (Only for service)
- ⑦ Coaxial signal (digital audio) output.
- ⑧ AUDIO output Terminal.
- ⑨ Earphone output Terminal.

● Connect antenna or video facility

1. Use 75 Ω coaxial cable plug or 300-75 Ω impedance converter to plug in antenna input terminal on the side of the cabinet.
2. Connect the video facility to the audio, video in jack on the left side of the cabinet.

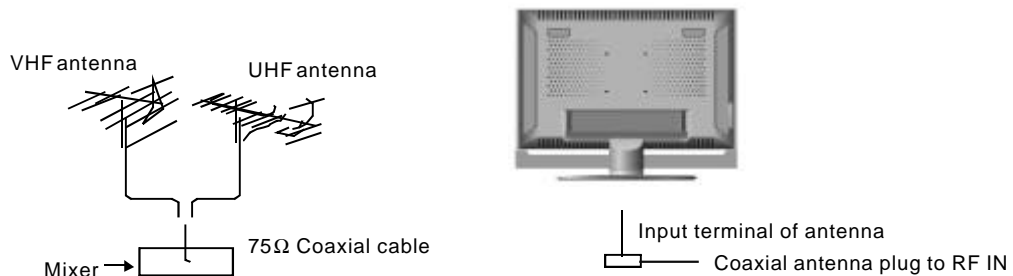

Accessories

Please check and identify the supplied accessories.

Remote control	x 1
Battery(AAA)	x 2
Warranty Card	x 1
Instruction Manual	x 1
Power Cord	x 1

Getting Started

USING THE REMOTE CONTROL

- Point the remote control at the remote sensor located on the unit.
- When there is a strong ambient light source, the performance of the infrared remote sensor. May be degraded, causing unreliable operation.
- The recommended effective distance for remote operation is about 16 feet (5 meters).

TO INSTALL THE BATTERIES

1. Open the battery door.

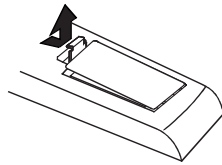

2. Insert 2 "AAA" batteries.

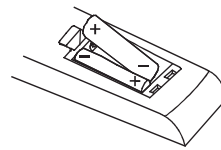

BATTERY REPLACEMENT

When the batteries become weak, the operating distance of the remote control is greatly reduced and you will need to replace the batteries.



CAUTION : Danger of explosion if battery is incorrectly replaced.

NOTES:

- If the remote control is not going to be used for a long time, remove the batteries to avoid damage caused by battery leakage corrosion.
- Do not mix old and new batteries. Do not mix ALKALINE, standard (CARBON-ZINC) or rechargeable (NICKEL-CADMIUM) batteries.
- Always remove batteries as soon as they become weak.
- Weak batteries can leak and severely damage the remote control.



WARNING:

Do not dispose batteries in a fire. Batteries may explode or leak.
Batteries shall not be exposed to excessive heat such as sunshine, fire or the like.

Remote Control Key Functions

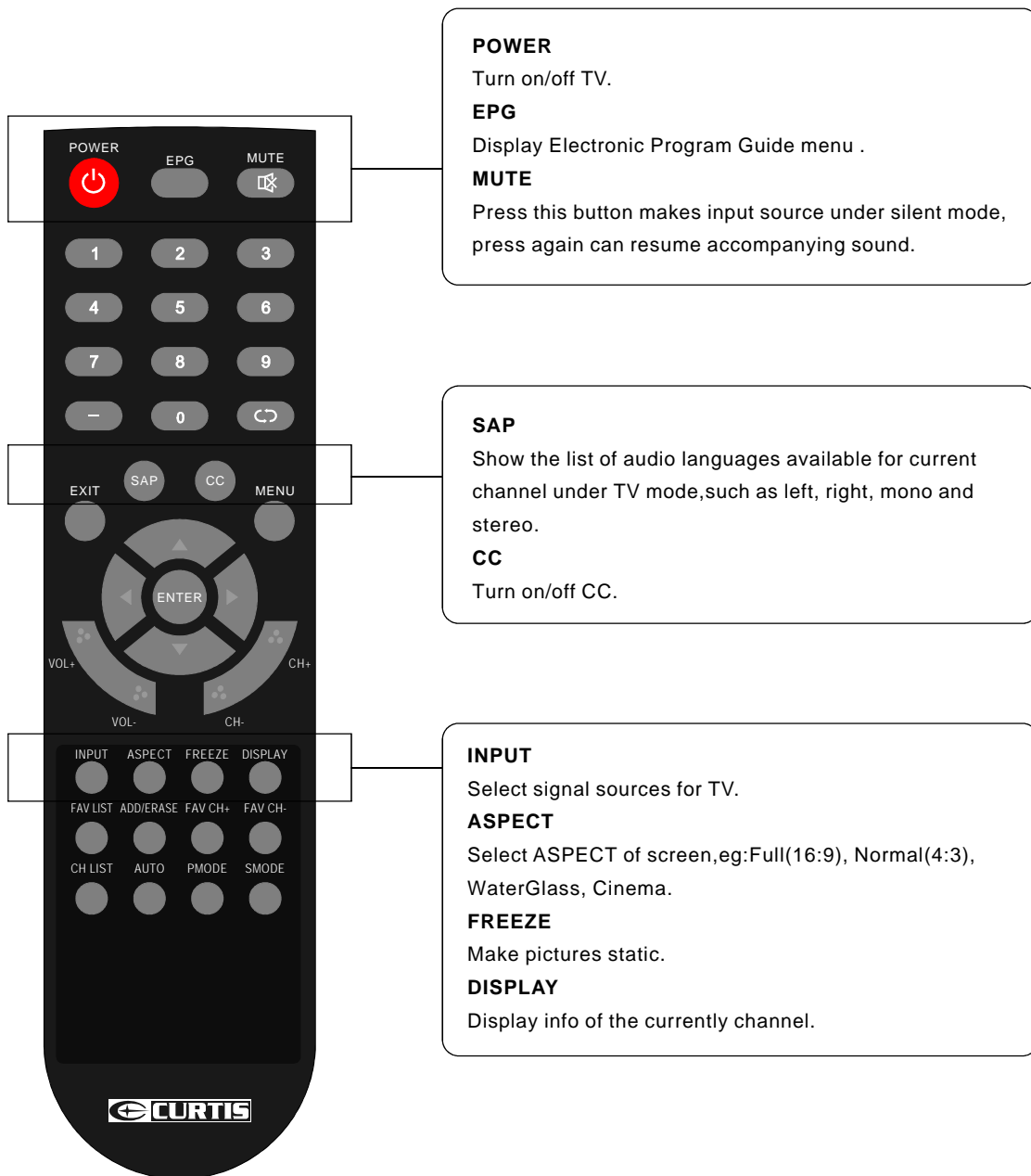

Remote Control Key Functions

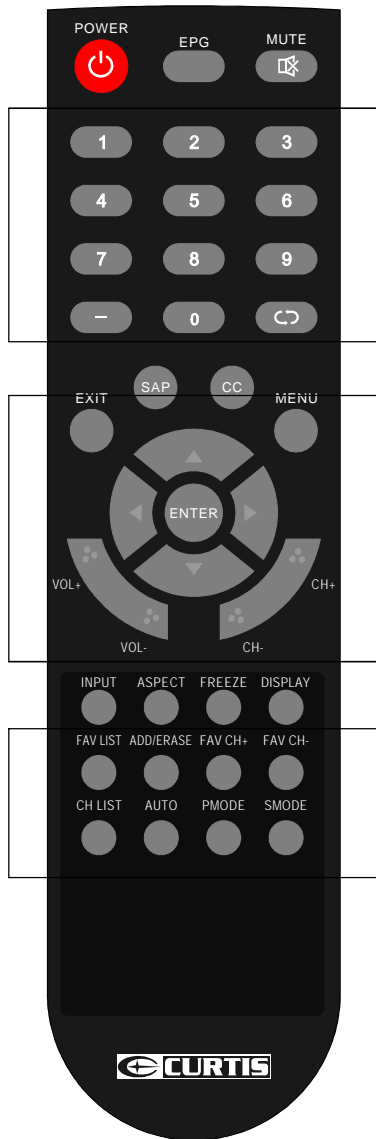

Universal Remote Code(NEC): 0x80FF

0~9 /-

Press any number of 0~9 buttons to select a TV channel , also can be used in Teletext Page choosing.
Press " - " to enter a program number for multiple program channel, such as 2-1 etc.



Return to previous channels after changing channels.

EXIT

Exit menu or sub menu of TV.

MENU

Brings up LCD main menu on screen.

▼/▲◀/▶ / ENTER

Allows you to navigate on-screen menus and adjust system settings to your preference.

VOL+/-

Increase/decrease the sound volume.

CH+/-

Change channels UP/DOWN.

FAV LIST

Display FAV menu under TV mode.

ADD/ERASE

Add or delete Favorite channel.

FAV CH+

Change forward Fav channel for TV.

FAV CH-

Change backward Fav channel for TV.

CH LIST

Display channel list.

AUTO

Auto calibration in PC mode.

PMODE

Cycle through available video picture modes.

SMODE

Cycle through different sound settings.

Select Input Source

- Press **INPUT** button to display the input source list;
- Press **▼/▲** button to select the input source you want to watch;
- Press **ENTER** button to enter the selected source.

Source Select
TV
AV
YPbPr1
YPbPr2
HDMI1
HDMI2
HDMI3
PC

Basic Operation



- Press **MENU** button to display the MAIN OSD MENU;
- Press **◀/▶** button to select the MENU you want;
- Press **ENTER** button to enter the sub menu;
- Press **▼/▲** button to select the option and then press **◀/▶** to adjust the value in the sub menu;
- You can press **MENU** button to go back to the upper menu or **EXIT** button to close the OSD.

Picture Menu

TV / AV / YPbPr / HDMI source.

- **Picture Settings**

Press **ENTER** button to enter the sub menu.

Picture Mode

Available picture mode: Movie, User, Dynamic, Standard.

Brightness, Contrast, Color, Tint, Sharpness

Only in the User mode, the detail options as following can be adjusted.

(Tint will only show when the color system is NTSC.)

- **Screen Settings**

Press **ENTER** button to enter the sub menu.

Screen Size

Available Screen Size: WaterGlass,Cinema,Full, Normal.

Auto Wide

Press **ENTER** button to adjust. It can set the picture to fit the screen automatically. When the Auto Wide is selected, the symbol will show as following:



- **Color Temperature**

Available color temperature: Cool, Normal, Warm.

- **Advanced Picture Settings**

Press **ENTER** button to enter the sub menu.

Dynamic Contrast

It can adjust the contrast corresponding to the input signal in order to improve the picture quality displayed.

(Available Mode: Off,Low,Medium,High)

Film Mode

It handles 3:2 pull down and 2:2 pull down.

(Available Film Mode: On/Off)

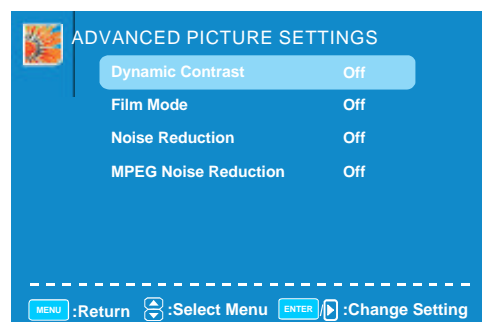
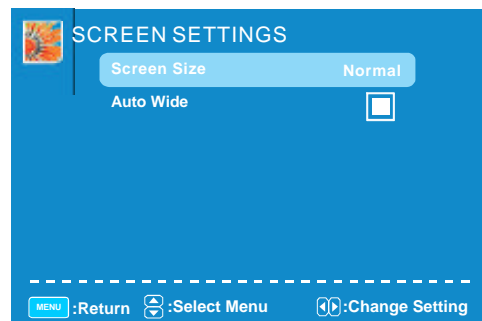
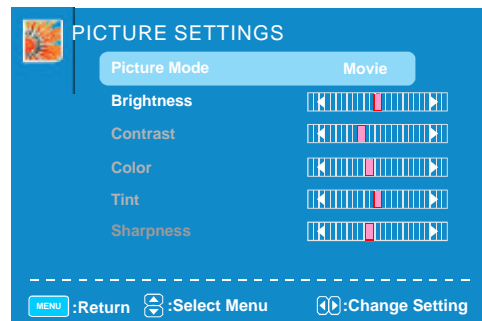
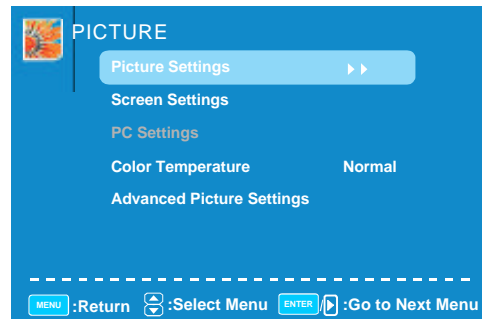

TV Operation

Noise Reduction

Available Noise Reduction: Low, Medium, Off,High.

MPEG Noise Reduction

It can improve the quality of the pictures by reducing the block noise.

(Available MPEG Noise Reduction: Low, Medium, Off,High)

PC source.

- **Picture Settings** menu and description are the same as that for TV source.

- **Screen Settings**

Press **ENTER** button to enter the sub menu.

Screen Size

Available Screen Size: Full, Dot By Dot.

Auto Wide

Auto Wide item is invalid in PC source.

- **PC Setting**

Press **ENTER** button to enter the sub menu.

Auto Adjust

Press **ENTER** button to start auto adjusting.

Horizontal Position

Adjust the H-Position.

Vertical Position

Adjust the V-Position.

Clock

Adjust the sampling frequency.

Phase

Adjust the sampling phase.

Reset

Press **ENTER** button to reset the options above.

- **Color Temperature**

Available color temperature: Cool, Normal, Warm.

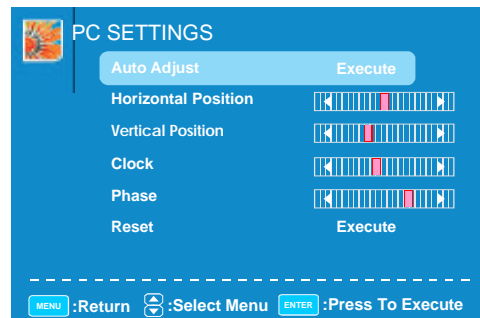
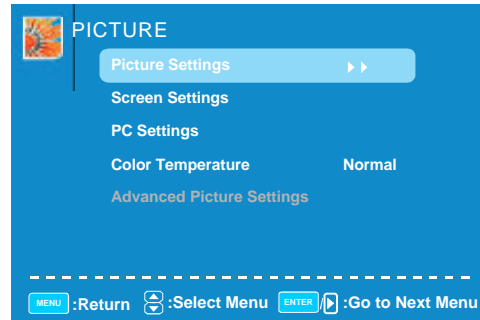

Sound Menu

SOUND menu and description are the same as that for TV .But The settings for Analog Sound and Digital Sound are invalid in AV / YPbPr / HDMI / PC source.

- **Sound Settings**

Press **ENTER** button to enter the sub menu.

- **Sound Mode**

Available Sound Mode: User, Dynamic, Standard, Soft.

- **Bass, Treble, Balance**

Only in the User mode, the detail options as following can be adjusted.

- **Surround Mode**

Press **ENTER** button to adjust.

When the Surround Mode is selected, the symbol will show as following:



- **Analog Sound**

Available Analog Sound: SAP, Stereo, Mono.

- **Digital Sound**

Available Digital Sound: English, French, Spanish.

- **Other Settings**

Press **ENTER** button to enter the sub menu.

- **AVL**

Select ON or OFF. Auto Volume Level can set the volume automatically adjust corresponding to the input audio.

- **Speaker**

Select ON or OFF. If set it Off, the speaker will be mute.

- **Digital Audio Output**

Available digital audio output: Dolby Digital, Off, PCM.

- **Equalizer Mode**

Available Equalizer Mode: POP, USER, OFF, ROCK, JAZZ.

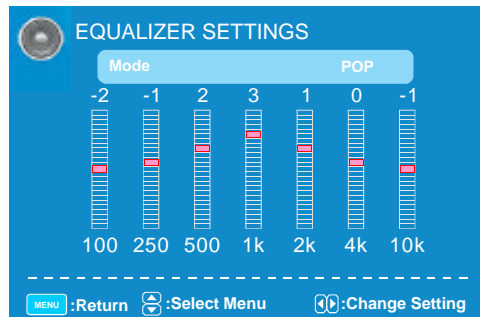
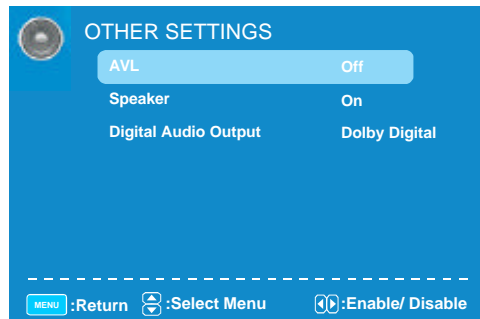
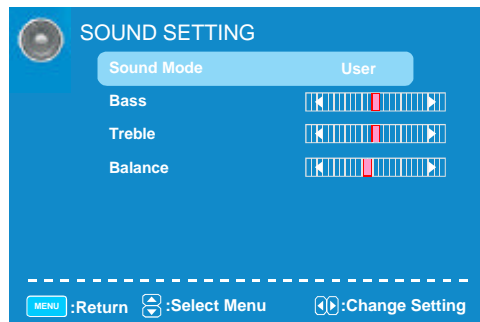
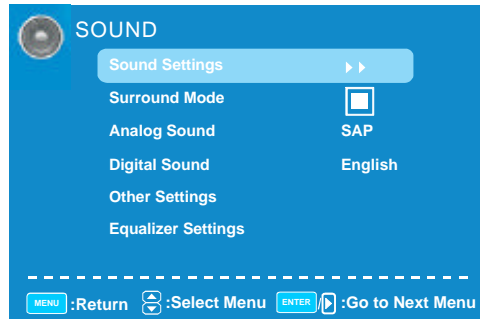

Channel Menu

NOTE:

This menu is only shown when the input source is TV .

- **Channel List**

Press **ENTER** button to scan the Channel List. If you select the option “ In Channel List ” On, the channel label will display.

- **Favorite List**

Press **ENTER** button to scan the Favorite Channel List.

- **Channel Setting**

Press **ENTER** button to enter the sub menu.

Channel Number

Press ◀/▶ button to select the Channel Number or press the number buttons to select the channel you want to set.

In Channel List

Press **ENTER** button to Add or Delete the current channel in the channel list.

Channel Label

Press ◀/▶ button to set the channel lable. After finishing the setting, Press **ENTER** button to save the channel lable.

Favorite Channel

Press **ENTER** button to Add or Delete the current channel in Favorite.

- **Signal Type**

There are two selections: Air and Cable.

- **Auto Channel Search**

Press **ENTER** button to search channel.

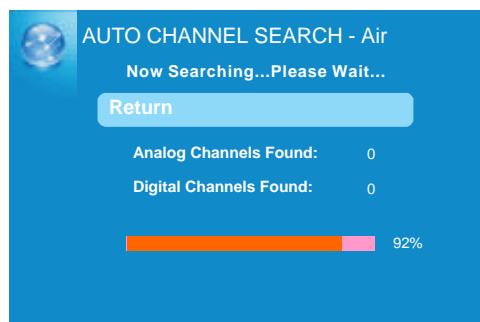
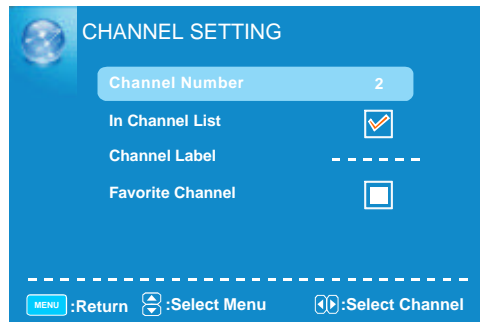
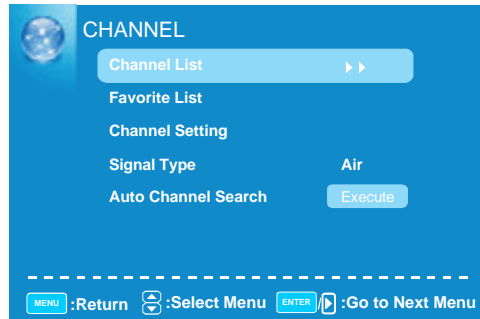

Parental Control

PARENTAL menu and description are the same as that for TV source. Input password to enter, default password is “ 0000 ” .

● **V-CHIP**

Press **ENTER** button to enter the sub menu.

US V-CHIP

Press **ENTER** button to enter the sub menu.

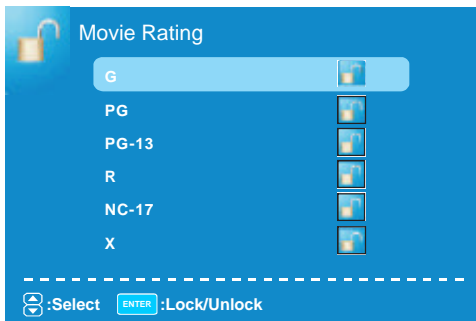
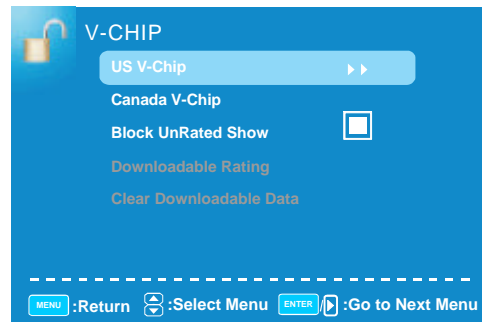
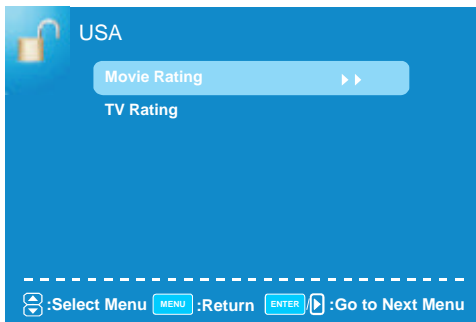
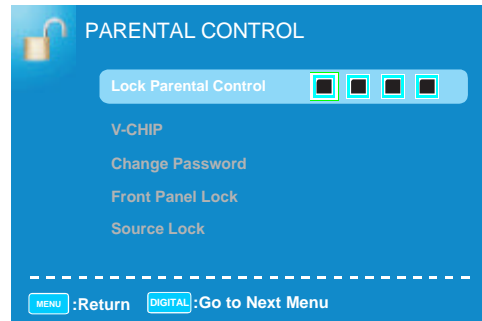

Movie Rating

Press **▼/▲** button to select Rating;
press **ENTER** button to lock.

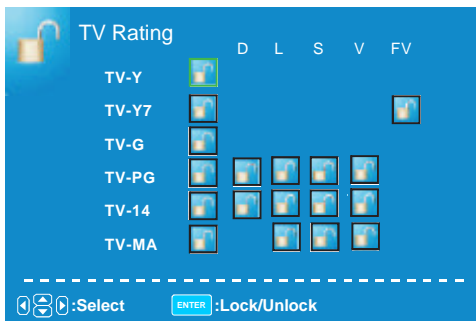

TV Rating

Press **▼/▲/◀/▶** button to select Rating;
press **ENTER** button to lock.

TV Operation

CANADA V-CHIP

The operation of CANADA V-CHIP is the same as the operation of US V-CHIP.

Block UnRated Show

Press **ENTER** button to set the rating locked.

Downloadable Rating

Press **ENTER** button to set the rating. If the DTV program doesn't have this rating information, this option will be in gray.

Clear Downloadable Data

Press **ENTER** button to set the rating .

NOTE: The above two operation only valid when playing the downloadable data stream.

The operations are the same as US V-CHIP.

- **Change Password**

If the password is changed, all of the passwords in the menu will be changed at the same time.

NOTE:

If you forget your password, you can use “ 1470 ” to enter any menu locked.

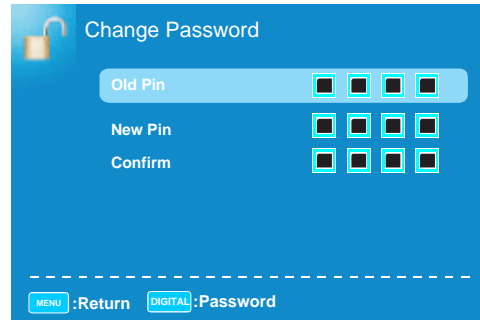

- **Front Panel Lock**

Press ◀/▶ button to select On or Off. You can only use the Power button on the TV when setting Front Panel Lock On.

- **Source Lock**

Press **ENTER** button to enter the sub menu.

Press ▼/▲ button to select Source , then press **Enter** button to set the Source Lock .

You can't enter the locked source if you set the Source lock.

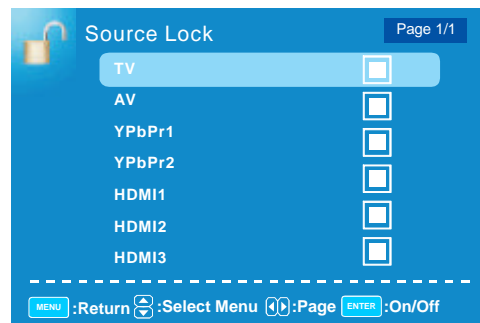

Setup Menu

SETUP menu and description are the same as that for TV source. But the setting for Closed Caption is invalid in HDMI/PC source .

- **Closed Caption**

Press **ENTER** button to enter the sub menu.

Caption Display

Select ON or OFF.

Analog Caption Type

Available type: TEXT1,TEXT2,TEXT3,TEXT4,CC1, CC2,CC3,CC4.

Digital Caption Type

Available type:Service1-6.

Digital CC Preset

Select Default or Custom.

Digital CC Style

This menu is only shown when the Digital CC Preset is selected Custom. Press **ENTER** button to enter the sub menu.

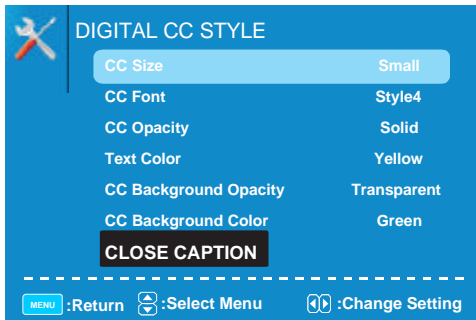
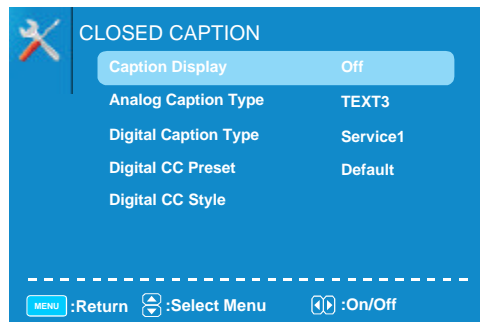

CC Size

Available Size: Small,Standard,Large,Default.

CC Font

Available type: Style0~7.Default .

CC Opacity

Available Opacity:Flashing,Default,Solid,Translucent, Transparent.

Text Color

Available Color: Blue,Yellow,Red,Black,White,Green, Magenta,Cyan,Default.

CC Background Opacity

Available Opacity:Flashing,Default,Solid,Translucent, Transparent.

CC Background Color

Available Color: Blue,Yellow,Red,Black,White,Green, Magenta,Cyan,Default.

TV Operation

- **Menu Language**

Available Language: English, French, Spanish, Deutsch.

- **Sleep Timer**

Let you select amount of time before your TV turn itself off automatically.

- **Clock**

Press **ENTER** button to enter the sub menu.

Time Zone

Available Size: Hawaii, Alaska, Eastern, Central, Mountain, Pacific, Samoa, Newfoundland, Atlantic.

Auto Clock

Set it On or Off. If you set it On, it will adjust the time corresponding the DTV time automatically.

Setup Time

Adjust the time and use the **ENTER** button to go to the next option.

Day Of Week

This option displays the Day Of Week corresponding to the setup time.

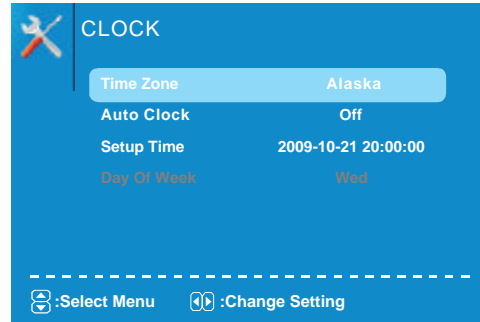

Others Menu

OTHER menu and description are the same as that for TV source.

- **Blue Back**

Press **ENTER** button to select when there is no signal, whether set the background in blue or not.

- **No Signal Power Off**

Press **ENTER** button to select it On or Off. When set it On and there is no signal input, it will turns off the panel and the LED light turns red.

- **No Operation Power Off**

Press **ENTER** button to select it On or Off. When set it On and there is no operation input, it will turns off the panel and the LED light turns red.

- **All Reset**

Press **ENTER** button to execute reset . When you select All Reset item, a dialogue box will appear as following.

Attention!
If [All Reset] was executed
TV system is reset.

- **Audio Only**

Press **ENTER** button to enter the sub menu.Hold on power key 3 sec. to restore video. Then there will be only audio output.To wake up video, please press **Power** button for 3 secretary.

AUDIO ONLY

Audio Only

Execute

Hold on power key 3 sec. to restore video

:Select Menu :Press to Execute



Wall Mount Install Ation

INSTALLING / REMOVING THE BASE STAND

WARNING :

The LCD Display is very fragile , and must be protected at all times when removing the base stand. Be sure that no hard or sharp object or anything that could scratch or damage the LCD display comes into contact with it. Do NOT exert pressure on the front of the unit at any time because the screen could crack .

1. Disconnect all cables or cords connected to the unit.
2. Lay the unit down on a flat sur face with the back side facing up . Please make sure to place a sof t cushioned material (such as a pillow or thick piece of foam) beneath the screen.
3. To remove the base stand , loosen screws off the holes then pull downwards to release the base stand.
4. To install the base stand , put the stand into the hole at the bottom of the TV then insert screws to the holes and tighten.

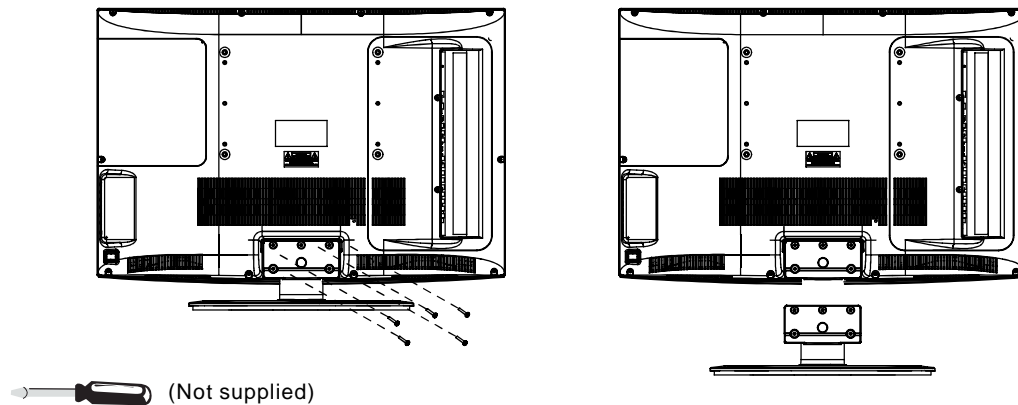

MOUNTING ON THE WALL

This unit is VESA-compliant, and is designed to be wall-mounted with a VESA-compliant 12" x 8" (300mm x 200mm) mounting kit designed for flat-panel TVs (not supplied). Mount this unit according to the instructions included in the mounting kit.

Length of screw should not exceed 10 mm.

NOTE:Remove the base stand before mounting the unit on the wall.

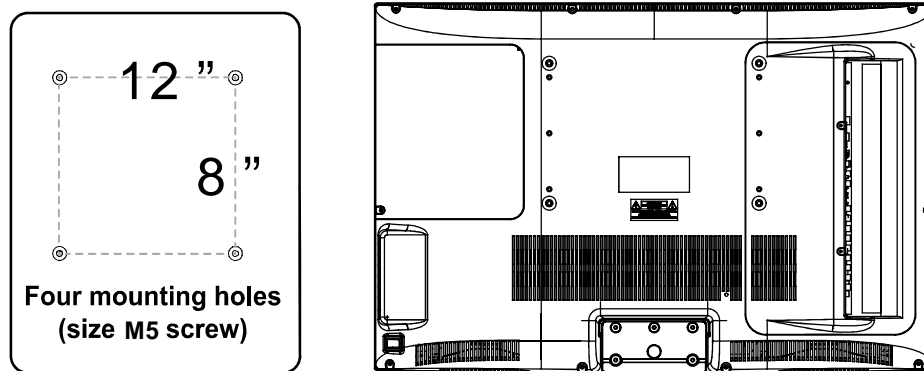

Specifications

Television RF system	NTSC M+ATSC
Video Color System	PAL/NTSC
Channel and frequencies	AIR CH2 - CH69 CABLE CH1 - CH135
Power input	AC 110 - 240V, 50/60 Hz
Power consumption	see the ration label
Audio output	6W +6W (Rated output)

Simple Troubleshooting

If the display fails or the performance dramatically, check the display in accordance with the following instructions. Remember to check the peripherals to pinpoint the source of the failure. If the display still fails to perform as expected, connect the dealer for assistance.

Symptom	DEALING METHOD
No Power	Check the power connection. Pull the plug out, wait for 60 seconds, then reconnect the power and turn on the set.
No Sound	Increase the volume. Check that if the set is on the mute state or not. Check the voice setting condition. Check the voice mode setting condition.
No Response Of the remote control	Check the effect of the batteries. If needed, please replace the batteries or clean the remote control sensor window. The distance between the set and the remote control should be less than 6 meters.
The Screen Flash In VGA Mode	The parameter is too big. Please use saftey mode when restart the PC, and set the parameter of the monitor according to the instruction.
Some Interfere In The VGA Mode	Please modify parameter of the monitor according to the instruction.
Abnormal Color	Check the antenna connection.
Clean The TV Set	Please pull the plug out when clean the LCD screen. Using soft, clean cloth to wipe it off. If need to clean further, please use dr cloth, don't use naphtha or other thinner liquid.