

## Before You Begin

- Verify all of the contents of your accessory package
- Review safety guidelines in Owner's Manual
- Place your High Definition TV so that the rear connectors are accessible
- Install AA batteries into the VIZIO Remote Control
- Write down your VP504F 10A Serial Number (located on the back)

### Contents:

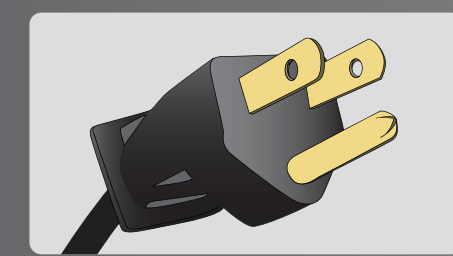

Power Cord

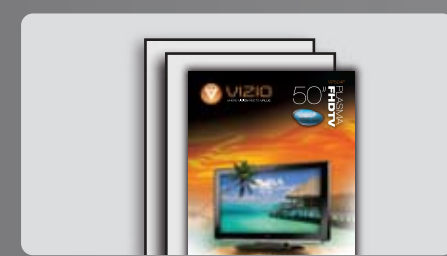

VIZIO HDTV User Manual, VIP Brochure and Registration Card.

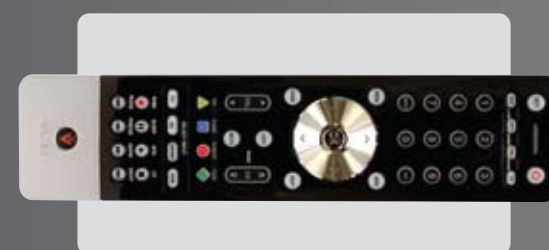

Remote Control  
Includes 2 AA Batteries

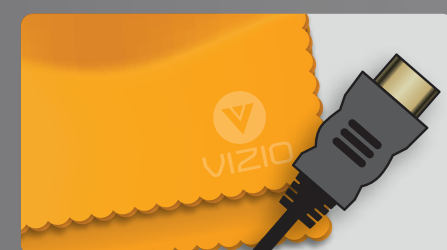

Screen Cloth & HDMI Cable

## The Best Connection

For the best quality picture, we recommend using HDMI, DTV, RGB or Component inputs when possible. These are the only inputs capable of high definition (HD). Using these inputs does not guarantee high definition unless a high definition source is connected. However, not all equipment is capable of these connections. TV, AV and S-Video are not capable of HD signals.

+ Both DTV and TV share the same port. The television will automatically register which input type is connected.



## Four Easy Steps

Simply follow our color-coded Step Charts and you're done.

### 1) Choose items to connect to your VIZIO HDTV

- Determine which type of Signal Source and any Additional Equipment you wish to connect to your VIZIO HDTV.
- The colored dots under each Signal Source and Additional Equipment indicate which type of connections you may use to connect to your VIZIO HDTV.

Signal Sources					Additional Equipment							
Cable	Antenna	Cable Box	Digital Cable Box	Satellite Box	Computer	Digital Camera	DVD	DVR	Game System	Sound System	VCR	Video Camera
			○	○			○	○	○			
			○	○			○	○	○			
			○	○			○	○	○			
			○	○			○	○	○			
●	●	●									●	
					●							
			●	●		●	●	●				
			●	●		●	●	●				
												●
											○	

### 2) Choose equipment connection methods

- Using the colored dots from Step One, follow the row across to Step Two to match up the colored dots to the same colored connection method.
- Choose ONLY one method for each piece of equipment.

Connection Methods
<b>HDMI 1</b> TYPE: Digital High Definition QUALITY: Best Digital
<b>HDMI 2</b> TYPE: Digital High Definition QUALITY: Best Digital
<b>HDMI 3</b> TYPE: Digital High Definition QUALITY: Best Digital
<b>HDMI 4</b> TYPE: Digital High Definition QUALITY: Best Digital
<b>DTV / TV</b> TYPE: Cable/Antenna QUALITY: Best Digital/Good Analog
<b>RGB PC</b> TYPE: RGB Analog QUALITY: Best Analog
<b>COMPONENT</b> TYPE: Component Analog QUALITY: Better Analog
<b>AV/S-VIDEO</b> TYPE: Analog QUALITY: Good Analog
<b>OPTICAL</b> TYPE: Digital Audio Out QUALITY: Best Digital
<b>AUDIO OUT</b> TYPE: Analog Audio Out QUALITY: Good Analog

### 3) Select cables and make connections

- Once you have determined the connection methods from Step Two, follow the row to Step Three to determine what kind of cables you need and what the connections look like on your equipment.
- Following the color-coded system, use the appropriate cables and connect your Signal Source and Additional Equipment to the color-coded inputs on your VIZIO HDTV. (Refer to **Connection Map** at bottom of page.)
- Once connected, turn on your VIZIO HDTV and all your equipment.

My Equipment Has	My VIZIO HDTV Has	Cable Needed
HDMI	HDMI	HDMI*
HDMI OR DVI	HDMI	HDMI* or HDMI* to DVI & RCA Audio
HDMI	HDMI	HDMI*
HDMI	HDMI	HDMI*
Coaxial	Coaxial	Coaxial (RF) Cable*
VGA & Optional Audio	VGA & Optional Audio	VGA Cable & stereo mini-jack
Component & Stereo RCA	Component & Stereo RCA	Component & Stereo RCA Cable*
AV RCA & S-Video	AV RCA & S-Video	AV RCA Cable or S-Video Cable & Stereo RCA Cable
Optical Audio	Optical Audio	Optical Audio Cable
Stereo RCA	Stereo RCA	Stereo RCA Cable

### 4) Use your VIZIO HDTV

- Follow the programming instructions on the other side of this guide.
- If you are using the DTV/TV input, turn over this guide and follow Procedure 1.
  - If you are using an input other than DTV/TV, turn over this guide and follow Procedure 2.

## 3 WAYS TO GET HDTV

- 1) Off-Air antenna (using the DTV antenna input). To see if you are able to receive HD signals off-air and for help choosing the right antenna, visit [www.antennaweb.org](http://www.antennaweb.org).
- 2) Cable - Subscribe to HD programming through your local cable company (HD cable box required).
- 3) Satellite - Subscribe to HD programming through Direct TV or Dish Network (HD satellite receiver required).

For additional help with connecting components to your VIZIO TV, visit <http://ceaconnectionsguide.com> for an interactive guide

**In need of a particular cable to make the connection you want?**  
VIZIO-certified cables are available at [www.VIZIO.com](http://www.VIZIO.com) (view back for more details).

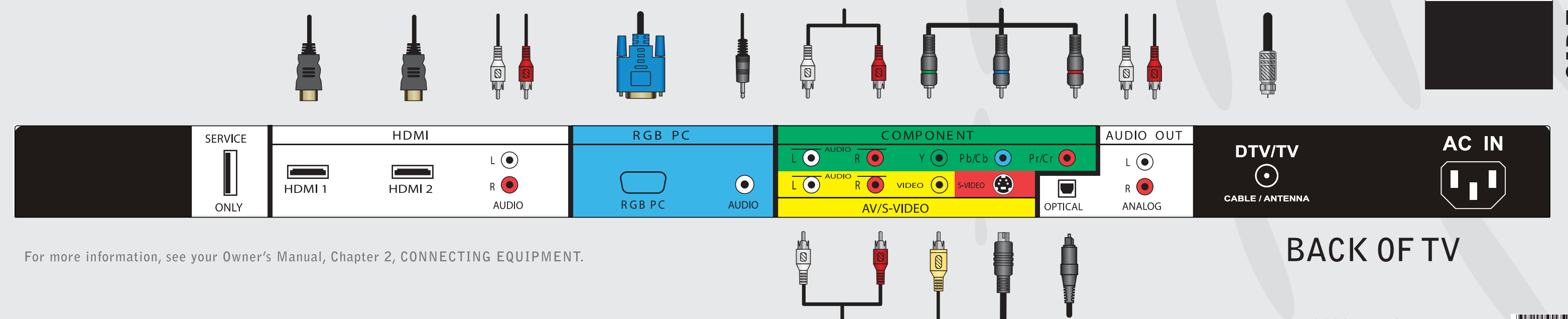

VIZIO provides installation services, cables & wall mounts (see details for Optional Components on back). Visit [www.VIZIO.com](http://www.VIZIO.com) or call 1-888-849-4623 to order today.

## Programming your TV to Receive and Display Channels: All you need is your Remote Control.

### 1 Receiving Channels through DTV/TV Input using Regular Antenna or Regular Cable Service (No Box) Signals.

#### STEP 1.1

**A** Connect your signal source (cable from antenna or cable from the wall for Cable Service without box) directly to the DTV/TV RF (commonly named COAXIAL) connector.

#### STEP 1.2

**A** Turn on the TV. The Initial Setup menu screen should appear. If this screen does not appear see User's Manual, Chapter 3 for TV Tuner Setup.

**B** Press **▶** key to initialize the process.

**C** Select Language: English, Español, Français. Press **▶** button to go to next screen.

**D** Press **▲** or **▼** once to select Cable or Antenna.

**E** Press **▶** to continue to next screen.

**F** Press **▶** key on remote control to scan for channels. Scanning for available channels could take several minutes.

**G** Once scanning is finished, programming is complete. Press the **LAST** key to exit.



### 2 Displaying Channels from different Signal Sources (External TV Tuner, VCR, Cable Box or Satellite Receiver) through different Inputs.

#### STEP 2.1

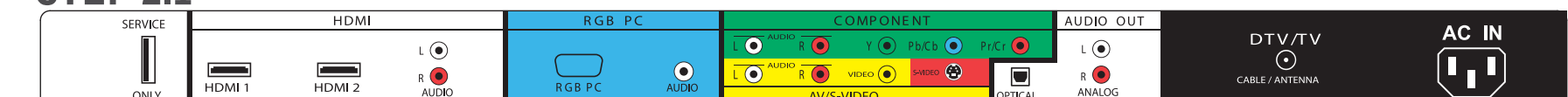

**A** Select the correct input connection; RF (DTV/TV)\* connector, Composite (Yellow, Red and White)\* connectors, Component (Red, Green, Blue plus Red and White)\* connectors, HDMI\* connectors or S-Video (AV)\* plus Red and White connectors (if applicable). Make the physical connection or hook up.

#### STEP 2.2

**A** Turn on the TV. The Initial Setup menu screen should appear. If this screen does appear, press **▶** on remote control to initialize the process. If the screen does not appear, please skip to Step D.

**B** Select Language: English, Español, Français.

**C** Press **LAST** key to exit the Initial Setup menu.

**D** If you have an HD service you must use the HDMI (best) or Component connection.

**NOTE:** Composite and S-VIDEO Cables can only be used for SD (480i) pictures.

**E** Turn on your Cable Box, VCR, External TV Tuner or Satellite Receiver and you will see a picture on your TV set. If there is not a picture, make sure you have selected the correct input on the TV set.

**F** If the selected input is RF connection, you should be aware that the TV set needs to be on either channel 3 or channel 4 matching the channel which has been selected on the back of the VCR, Cable Box, External TV Tuner or Satellite Receiver; please refer to Owner or User's Manual of such equipment for details.

**NOTE:** The TV set will be displaying any television station or program selected by the Cable Box, VCR, External Tuner or Satellite Receiver. The TV set will not be able to change programs or channels; this is controlled by the equipment sending the signal. If the service being used includes a box with two different outputs for two different (distant) rooms, then scanning channels should help to find the signal. Be aware that the channel to be selected varies from provider to provider, meaning you may have to call your provider company so they can provide you with the specific channel to use with high-definition TV sets. Some examples of these channels are: 105, 106, 115 and 116.



### 3 Fine Tuning your TV for Home Use.

After completing either Procedure 1 or Procedure 2, please follow the steps below to optimize your TV set display:

1. Press the **MENU** key to bring up the Menu display. Use the **▲** or **▼** button to scroll to the Advanced Video option.
2. Press the **▶** button to select it.
3. Press the **▲** or **▼** button to scroll to the Color Temperature option.
4. Press the **▶** button to select it.
5. Press either **◀** or **▶** button to change the Color Temperature option to Normal.
6. Press the **LAST** key to exit the on screen display Menu.

**NOTE:** If you followed Procedure 1, take the following steps to ensure that the correct program times are shown when pressing the Guide key:

Press the **MENU** key, which will bring up the picture mode menu. Pressing either the **◀** or **▶** button, scroll across to the icon showing a globe with an antenna. The next screen will appear showing Time Zone; using either the **▲** or **▼** button, select it, and finally by pressing either the **◀** or **▶** button, choose the proper Time Zone for your area. Press the **LAST** key to exit the on screen display Menu.



## \*For Your Information:

**A** Coaxial connection (RF connector) is recognized as the threaded connector, commonly called cable, screw on or coaxial connector which carries the image (picture) and sound (audio) through a single cable.

**B** Composite connection (RCA connectors) is recognized by the three (yellow, red and white) standardized color coded RCA connectors. Yellow carries the image (picture); red (right channel) and white (left channel) carry the sound (audio) of the signal.

**C** Component connection (RCA connectors) is recognized by the three (green, blue and red) standardized color coded RCA connectors for image (picture) plus the two (red and white) standardized color coded RCA connectors for the sound (audio) of the signal.

**D** HDMI (High-Definition Multimedia Interface) connection (HDMI connector) is recognized by the standardized elongated D-Shaped connector which carries both the image (picture) and the sound (audio) of the signal through a single cable.

**E** S-Video (separate video) connection (4-pin Mini-DIN connector) is recognized by the small connectors at the end of a cable with multiple pins in it. This connection carries only the image (picture) of the signal; therefore, there is a need to supply a separate sound (audio) signal by using the two (red and white) standardized color coded RCA connectors.

## Programming Your Cable or Satellite Box Remote

Consult your Cable or Satellite Owner's Manual to determine if you need a 3, 4 or 5-digit code. If your Cable or Satellite Box requires:

- 3-digits, please use "627" (This code usually works with DISHNetwork.)
- 4-digits, please use "1758", "0178" or "0128"
- 5-digits, please use "11758", "10178" or "10128" (These codes usually work with DIRECTV.)

## Your new TV set is now ready

to automatically reproduce the best picture quality from the input signal being fed into it. Enjoy your VIZIO HDTV.

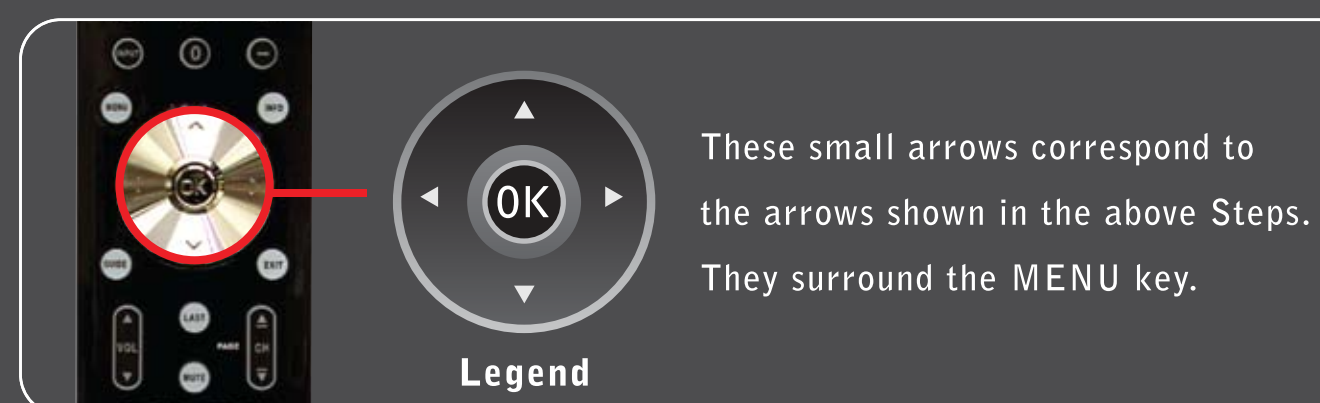

These small arrows correspond to the arrows shown in the above Steps. They surround the MENU key.

## Optional Components



### ENHANCE YOUR VIZIO EXPERIENCE

When it comes to components and accessories, don't settle for less than VIZIO. We offer a full line of products specifically designed to accentuate your VIZIO HDTV. To learn more about how you can enhance your VIZIO experience, call 888-849-4623 or visit [www.VIZIO.com](http://www.VIZIO.com).

### VIZIO HIGH-DEFINITION CERTIFIED CABLES

Our VIZIO Certified HD cables carry the same standards of excellence as all our VIZIO products. Available in: DVI, HDMI and Component in lengths of 2, 5, and 10 meters.



### VIZIO CERTIFIED MOUNTS

FLUSH MOUNT- turn your HDTV into a work of art  
TILT MOUNT- adjust your HDTV for the most comfortable viewing position  
ARTICULATING ARM- position your HDTV exactly where you want it

