

VIORE[™] TECHNOLOGY & INNOVATION

OPERATING INSTRUCTIONS

***19" HD LCD Television
with Built-in DVD Player
LCD19VH65***



Contents

Safety and warnings.....	2-4
Introduction.....	5
Installation.....	6-9
Remote Control.....	10
Operation.....	11-14
Caution and DVD SIDE PANEL.....	15
Features.....	15
General Steps of setup menu.....	16
Setup Items Introduction.....	16
DVD REMOTE CONTROL OPERATION.....	21
Mp3 PLAYBACK.....	22
DVD Trouble shooting.....	23
Trouble Shooting.....	24

SAFETY AND WARNINGS

IMPORTANT SAFETY INSTRUCTION

1. Read these safety instructions.
2. Keep these safety instructions.
3. Heed all warnings.
4. Follow all safety instructions.
5. Do not use this apparatus near water.
6. Clean only with dry cloth.
7. Do not block any ventilation openings. Install in accordance with the manufacturers instructions.
8. Do not install near any heat sources such as radiators , stoves, or other apparatus (including amplifiers)that produce heat.
9. Protect the power cord from being walked on or pinched particularly at power outlets, and the point where they exit from the apparatus.
10. Only use attachments/accessories specified by the manufacturer.
11. Unplug this apparatus during lightning storms or when unused for long periods of time.
12. Refer all servicing to qualified service personnel. Servicing is required when the apparatus has been damaged in any way, such as the power-supply cord or plug is damaged, liquid has been spilled or objects have fallen into the apparatus, the apparatus has been exposed to rain or moisture , does not operate normally, or has been dropped.
13. Apparatus must not be exposed to dripping or splashing and no objects filled with liquids, such as vases, should be placed on the apparatus.

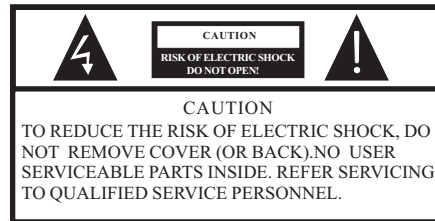

 The symbol indicates that dangerous voltages constituting a risk of electric shock are present within this unit.

 The symbol indicates that there are important operating and maintenance instructions in the literature accompanying this unit.

WARNING:

To prevent fire or shock hazard, do not expose this appliance to rain or moisture.

SAFETY AND WARNINGS

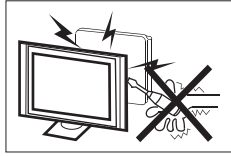

High voltages are used in the operation of this television receiver. Do not remove the cabinet back from your set. Refer servicing to qualified service personnel.



Never stand on, lean on, or suddenly push the television or its stand. You should pay special attention to children. Serious injury may result if it falls.

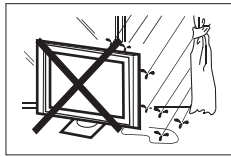

To prevent fire or electrical shock hazard, do not expose the television receiver to rain or moisture.

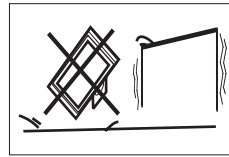

Do not place your television on an unstable cart, stand, shelf or table. Serious injury to an individual, and damage to the television, may result if it falls.



Do not drop or push objects into the television cabinet slots or openings. Never spill any kind of liquid on the television receiver.

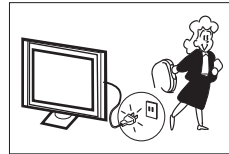

When the television receiver is not used for an extended period of time, it is advisable to disconnect the AC power cord from the AC outlet.



Do not block the ventilation holes in the back cover. Adequate ventilation is essential to prevent failure of electrical components.

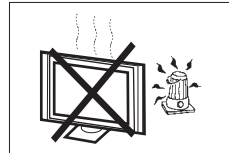

Avoid exposing the television receiver to direct sunlight and other sources of heat. Do not stand the television receiver directly on other products which give off heat, e.g. video cassette players and audio amplifiers. Do not place naked flame sources, such as lighted candles on the television.

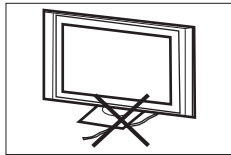

Do not trap the power supply cord under the television receiver.

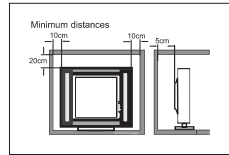

If the television is to be built into a compartment or similar enclosure, the minimum distances must be maintained. Heat build-up can reduce the service life of your television, and can also be dangerous.

SAFETY AND WARNINGS

Thank you very much for purchasing this TV. To enjoy your product from the very beginning, read this manual carefully and keep it handy for easy reference.



INSTALLATION

- Locate the TV in the room where light does not strike the screen directly.
- Total darkness or a reflection on the picture screen can cause eyestrain. Soft and indirect lighting is recommended for comfortable viewing.
- Allow enough space between the TV and the wall to permit ventilation.
- Avoid extremely warm locations to prevent possible damage to the cabinet or premature component failure.
- This TV can be connected to AC 100-240 Volts, 50/60 Hz. Never connect to a DC supply or any other power supply.
- Do not cover the ventilation openings when using the TV.

CAUTION

Never tamper with any components inside the TV, or any other adjustment controls not mentioned in this manual. All LCD-TV's are high voltage instruments. When you clean up dust or water drops on the LCD PANEL or CABINET, the power cord should be pulled out from the receptacle, then wipe the TV with a dry soft cloth. During thunder and lightning, unplug the power cord and antenna cord to prevent damage to your TV. All repairs to this TV should only be performed by qualified TV service personnel.

Earthing connection--- The apparatus shall be connected to MAINS socket outlet with a protective earthing connection. MAINS plug or appliance coupler of the apparatus is used as disconnect device, it should remain readily operable.

Warning: Change or modifications to this unit not expressly by the part responsible for compliance could void the user's authority to operate the Equipment.

NOTE:

This equipment has been tested and found to comply with the limits for a Class B digital device, pursuant to Part 15 of the FCC Rules. These limits are designed to provide reasonable protection against harmful interference in a residential installation. This equipment generates, uses, and can radiate radio frequency energy and, if not installed and used in accordance with the instructions, may cause harmful interference will not occur in a particular installation. If this equipment does cause harmful interference to radio or

television reception, which can be determined by turning the equipment off and on, the user is encouraged to try to correct the interference by one or more of the following measures:

- Reorient or relocate the receiving antenna.
- Increase the separation between the equipment and receiver.
- Connect the equipment into an outlet on a circuit different from that to which the receiver is connected.
- Consult the dealer or an experienced radio TV technician for help.

Shield cables must be used with this unit to ensure compliance with the Class B FCC limits.

INTRODUCTION

Main features

- ① Used as Television, display terminal, PC display;
- ② High luminance, wide viewing angle;
- ③ BTSC;
- ④ ATSC digital signals and NTSC analog signals TV.

Accessories

AC Power Cord.....	1
Infrared Remote Control.....	1
User's Manual	1
Battery(AAA).....	2

Main parameter

Viewing Picture Size(diagonal)	19inch
Resolution:	1440x900
Aspect Ratio:	16:10
TV System:	ATSC Digital system and NTSC Analog system
Video Signal System:	NTSC/PAL/SECAM
Receiving Channel:	Cable :1-135/ Air: 2-69(ATV&DTV)
Power consumption:	50W
Input Power Voltage:	AC 100V-240V 50/60Hz
Audio Output Power(THD ≤ 7%):	2x3W
Rear High-Definition Multimedia Interface(HDMI) Input	x 1
Rear S-Video Input	x 1
YCb(Pb)Cr(Pr) Input	x 1
Rear Coaxial SPDIF Output	x 1
Analog RGB(VGA) Input	x 1
Rear Audio Input	x 2
Horizontal definition(TV line)	Composite Video Input ≥350 Video Input ≥400 YCb(Pb)Cr(Pr) ≥400

Front panel

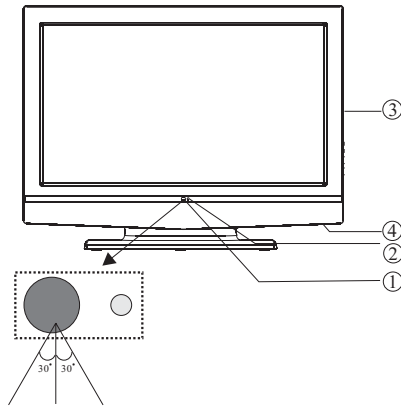

- 1: Remote control sensor.
- 2: Indicator LED: GREEN ● POWER ON.
RED ● STANDBY.
- 3: Key board
- 4: Power: Press this button to turn the unit ON from STANDBY mode. Press it again to turn the set back to STANDBY.

KEYBOARD

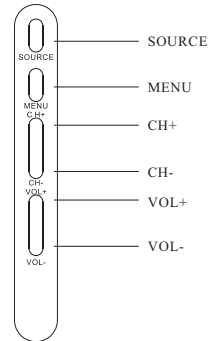

- 1. **SOURCE:**
Display the input source menu.
- 2. **MENU:**
Display main MENU.
- 3. **CH+/CH-**
In TV mode, press “CH+” or “CH-” to change the channel up and down.
In MENU mode, press “CH+” or “CH-” to select items .
In standby mode, press “CH+” or “CH-” to turn on the TV.
- 4. **VOL+/VOL-**
Adjust sound level.
In MENU mode, press “VOL+” or “VOL-” to adjust the item that you selected.

REAR AV Connection

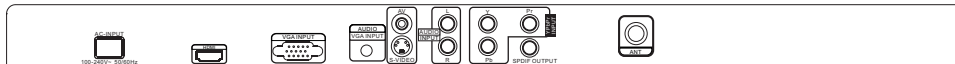

- All the terminals are(from left to right):
 AC POWER SOCKET, HDMI input,VGA ,PC AUDIO input, AV, S-VIDEO,Rear Audio input,
 YPbPr input, Coaxial SPDIF OUTPUT,ANTENNA SOCKET,
 Note: 1.AV,S-VIDEO and YPbPr share the Rear Audio input channel.
 2. When HDMI port get DVI signal,the PC Audio channel will change to receive the audio from HDMI port.

PC

STEPS:

Be sure both the TV and computer are set to Power off.

1. Connect VGA and audio cable.
2. Connect the power cord.
3. Power on the TV, switch to VGA mode.
4. Power on the VGA.

This sequence is very important.

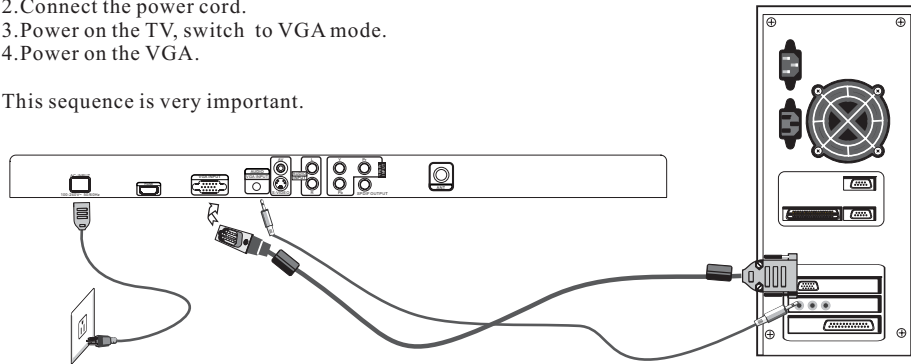

PRESET MODE

	RESOLUTION	V.Freq.(Hz)	H.Freq.(KHz)
1	720*400	70	31.47
2	640*480	60	31.47
3	640*480	75	37.50
4	800*600	60	37.88
5	800*600	75	46.88
6	1024*768	60	48.36
7	1024*768	70	56.48
8	1024*768	75	60.02
9	1280*1024	60	63.98
10	1280*1024	75	80.00

ANTENNA

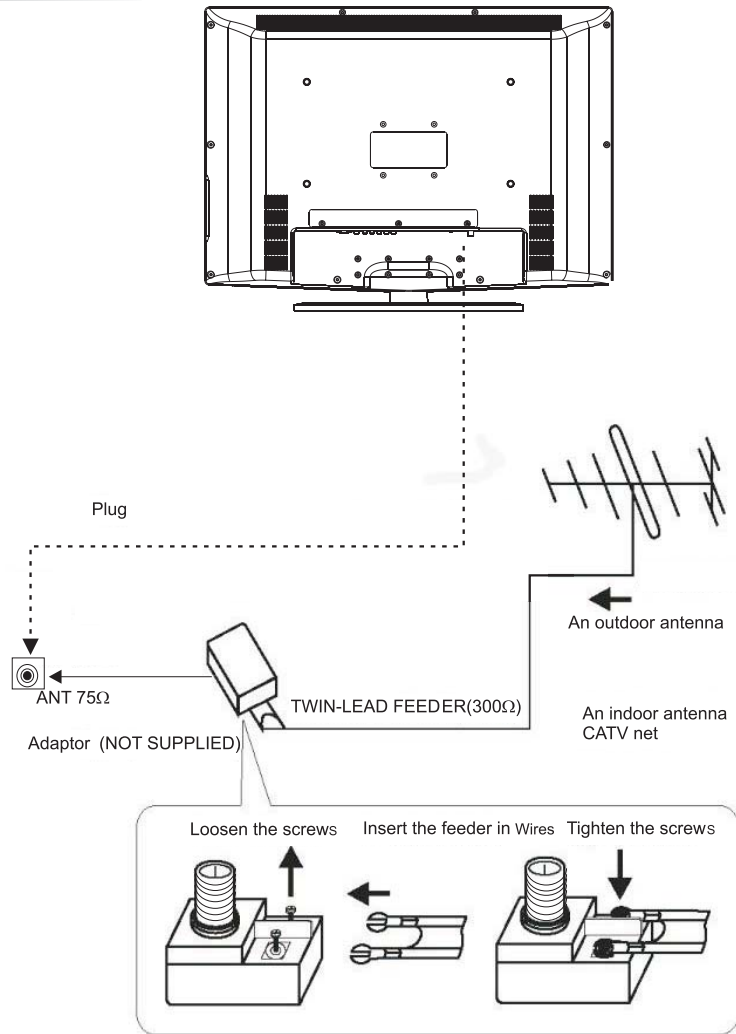

Note:
Aerial connections:IEC(female).
Input impedance:75Ωunbalanced.

AV EQUIPMENT

This TV provides one group of AV ,one group of S-Video,one group of YPbPr for convenient connection to VCR,DVD or other video equipment. Please refer to the owner s manual of the equipment to be connected as well.

You can use the input terminals on TV set rear as follows.

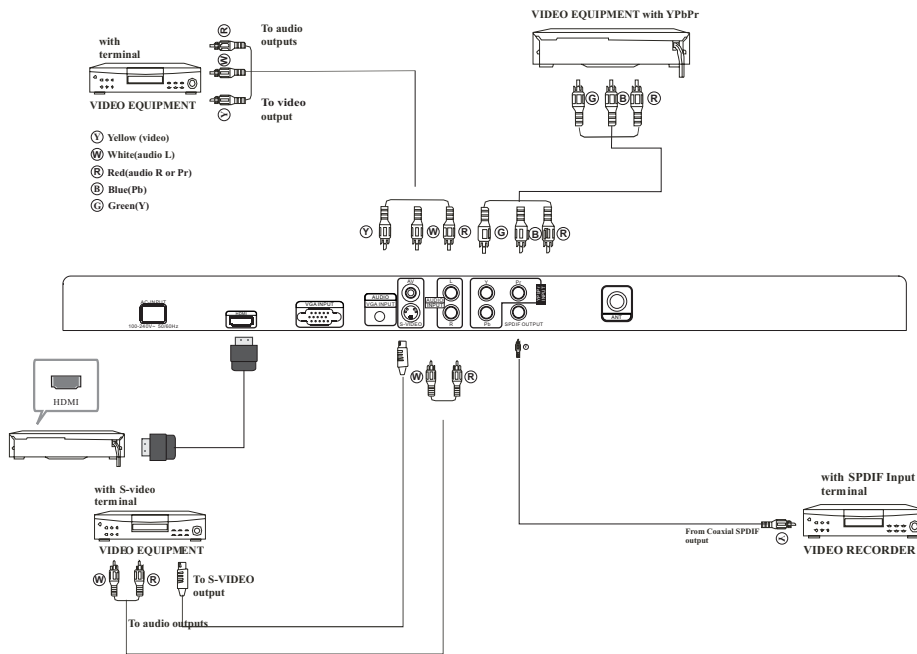

It can be connected to the following appliances: VCR, multi disc player, DVD, camcorder, video game or stereo system, etc....

YPbPr can support these video formats:480i,576i,480p,576p,720p,1080i,1080p,

REMOTE CONTROL

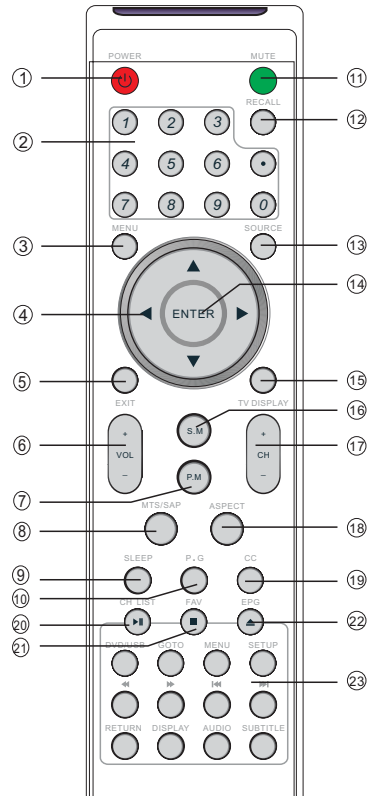

- 1: **POWER**
To set the TV standby or on.
- 2: **NUMBER KEY:**
For direct access to program.
- 3: **MENU**
To display TV menu or to return to the previous menu.
- 4: **CURSOR**
To move within the menu.
- 5: **EXIT**
Used to exit menu.
- 6: **VOL+/-**
To adjust sound level.
- 7: **P.M**
To switch picture mode.
- 8: **MTS/SAP**
Switch the sound stereo, SAP and mono.
- 9: **SLEEP**
Set time to turn off the TV.
- 10: **P.G**
Setting the Parental Control level control.
- 11: **MUTE**
To disable or enable the sound.
- 12: **RECALL**
To access the previously viewed program.
- 13: **SOURCE**
To display or exit TV input source menu.
- 14: **ENTER**
Confirms selection.
- 15: **TV DISPLAY**
Displays/removes the program Information
- 16: **S.M**
To switch sound mode.
- 17: **CH+/CH-**
To access the next or previous Program.
- 18: **ASPECT**
To change picture aspect .
- 19: **CC**
Enable or disable the CC function.
- 20: **CH LIST:**
Used to display the channel list
- 21: **FAV:**
Used to access your favourite channels in digital TV mode.
- 22: **EPG:**
Display all the information of DTV programs.
- 23: **DVD keys :**
Please refer to the user manual for DVD part .

Insert Batteries Into the Remote Control



1. Remove the battery cover.
 2. Inserting the 2 AAA 1.5V batteries making sure the polarity (+ or -) of the batteries matches the polarity marks inside the unit.
 3. Mount the battery cover.
- Replace with new batteries when the TV set begins to show the following symptoms:
Operation is unsteady or erratic. Sometimes the TV set does not function with Remote Control Unit.

Remark:

- 1) Alkaline Battery Recommended.
- 2) Remove batteries when they are exhausted or if the remote control is not to be used for long time.

1. PICTURE MENU

The first item of the MENU is PICTURE MENU. You can adjust picture effect here, such as contrast, brightness, etc.

Press ▼▲ to select, press ◀▶ to adjust, press MENU to exit.

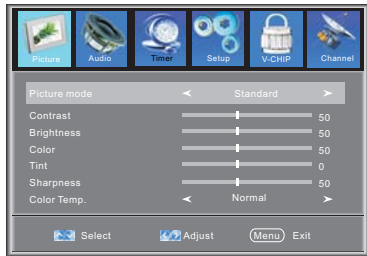

Note:

If you want to adjust contrast, brightness, color, and sharpness, the picture mode must return to "personal" status.

2.AUDIO menu

The second item of the MENU is AUDIO MENU. You can adjust sound here.

Press ▼▲ to select, press ◀▶ to adjust, press MENU to exit.

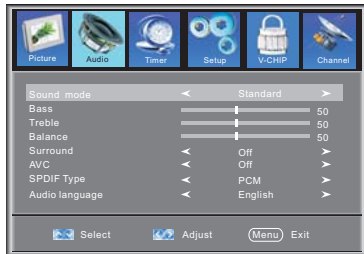

Note:

The item of Audio language is available in ATSC program.

3.TIMER MENU

The third item of the MENU is TIMER MENU. You can adjust time here.

Press ▼▲ to select, press ◀▶ to adjust, press MENU to exit.

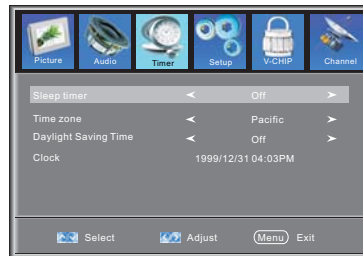

1).SLEEP TIMER: adjust this item, you can set the sleep timer.

Note:

The item of Time zone, the item of Daylight Saving Time and the item of clock are available in ATSC program

4. SETUP MENU

The forth item of the MENU is SETUP MENU. You can setup system here.

Press ▼▲ to select, press ◀▶ to adjust, press MENU to exit.

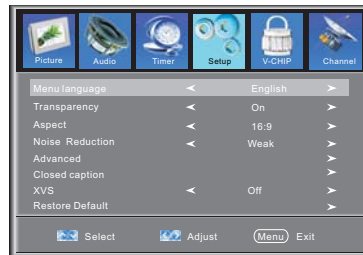

Note:

Restore Default: Reset all the settings to default value.

1). Advanced: In PC Mode is available.

Press ▼▲ button to select Advanced, Press ► button, the screen will display as follow:



- (1).H-Pos:Adjust the horizontal position of the screen.
- (2).V-Pos:Adjust the vertical position of the screen.
- (3).Clock: Fine tune the screen width.
- (4).Phase: Fine tune the phase of the screen. Usually don't adjust this item.
- (5).Auto: Auto adjust to fit the screen.

2). Closed Caption: switch close caption mode.

Press ▼▲ button to select Closed Caption, Press ► button, the screen will display as follow:

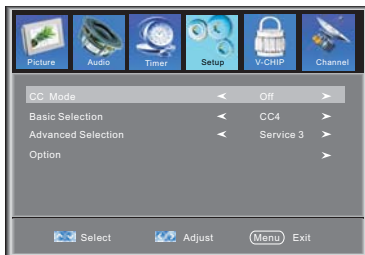

- (1):Advanced selection: only ATSC program is available.
- (2):Option:Used to edit CC font.

Press ► button, the screen will display as follow:

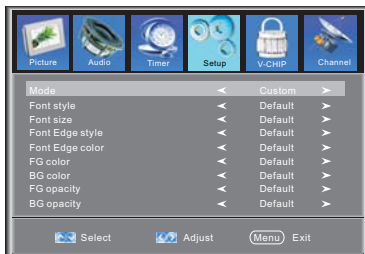

NOTE: Only ATSC program is available.

5. V-CHIP MENU

The fifth item of the MENU is V-CHIP MENU. You can setup Parental Control here.

Press ▼▲ to select, press ◀▶ to adjust, press MENU to exit.

Parent control: input the password, it will go into Parental Control menu. Factory default password is 6666.



5.1 .Input the correct password ,the screen will display as follow:

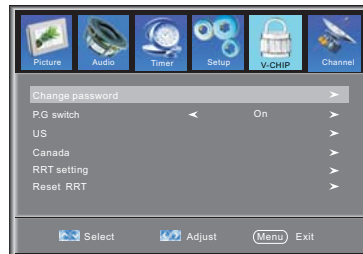

1). Change Password: Press ► button, the screen will display as follow:



- 1).New password: Input the new password
- 2).Confirm password: Input the new password again

5.2 V-CHIP switch:

When the Parental Control switch is ON, the below options can be adjusted.

5.3 US: Press ► button, the screen will display as follow:

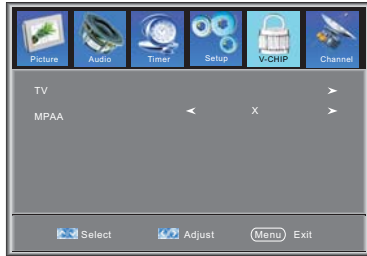

1):TV: Press ► button, the screen will display as follow:

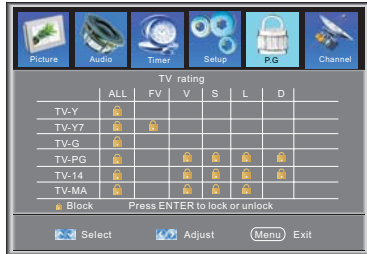

Rating	Content	Content				
		FV (Fantasy violence)	V (Violence)	S (Sexual situation)	L (Adult language)	D (Sexually suggestive dialog)
Suggested age	TV-Y (All children)					
	TV-Y7 (Direct to order children)	X				
	TV-G (General audience)					
	TV-PG (Parental Guidance suggested)		X	X	X	X
	TV-14 (Parents strongly cautioned)		X	X	X	X
	TV-MA (Mature audience only)		X	X	X	

And use ENTER key to switch lock/ unlock Parental Control feature.

2).MPAA:switch the movie-rating control level; N/A, G,PG, PG-13,R,NC-17,X.

Rating	Description	
Age	G	General audiences, All Ages admitted
	PG	Parental Guidance suggested. Some material may not be Suitable for children.
	PG-13	Parents strongly cautioned. Some material .may be Inappropriate for children under 13.
	R	Restrict. Under 17 requires accompanying parent or adult guardian(age varies in some jurisdictions)
	NC-17	No one 17 and under admitted.
	X	X is an order rating that is unified with NC-17 but may be encoded in the data of order movies.

5.4 Canada: Press ► button, the screen will be displayed as follow:

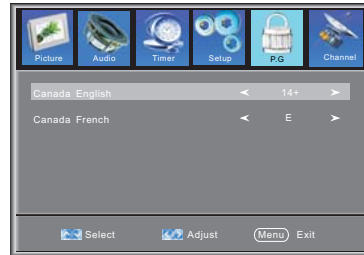

1): Canada English: switch the english rating control level:E,C,C8+,G,PG,14+,18+.

Rating	Description	
Age	E	Exempt: Includes news, sports, documents and other information programming: talk shows, music videos, and variety programming.
	C	Children: Intended for younger children under the age of 8 years. Pays careful attention to themes that could threaten their sense of security and well-being.
	C8+	Children over 8 years old: Contains no portrayal of violence as the preferred, acceptable, or only way to resolve conflict; nor encourage children to imitate dangerous acts which they may see on the screen.
	G	General: Considered acceptable for all age groups, Appropriate viewing for the entire family, contains very little violence, physical, verbal or emotional.
	PG	Parental Guidance: Intended for a general audience, but may not be suitable for younger children (under the age of 8) because it could contain controversial themes or issues.
	14+	Over 14 Years: Could contain themes where violence is one of the dominant elements of the storyline But it must be integral to the development of plot or character. Language usage could be profane and nudity, present within the context of theme.
18+	Adults: Intended for viewers 18 years and older and might contain depictions of violence, which while related to the development of plot, character or themes, are intended for adult viewing. Could contain graphic language and portrayals of secretary and nudity.	

2).Canada French: switch the French-rating control level: E, G,8ANS+,13 ANS+,16ANS+,18ANS+.

Rating	Description
E	Exempt programming
G	General :All ages and children, contains minimal direct violence, but may be integrated into the plot in a humorous or unrealistic manner .
8ans+	General but inadvisable for young children :May be viewed by a wide public audience, but could contain scenes disturbing to children under 8 who cannot distinguish between imaginary and real situations. Recommended for viewing with paren.
13ans+	Over 13 years: Could contain scenes of frequent violent scenes and in tense violence.
16ans+	Over 16 years: Could contain frequent violent scenes and violence.
18ans+	Over 18 years: Only for adult viewing. Could contain frequent violent scenes and extreme violence.

- 1). Air/Cable: select Air TV signal and cable TV signal.
- 2). Auto Scan: If it's the first time you use the TV, you should scan all the TV channels first, press the ► button to confirm, you will see below menu :

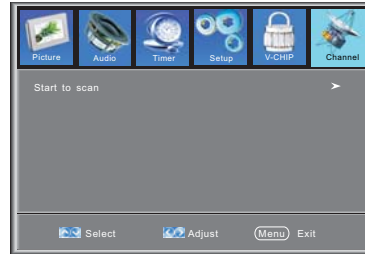

5.5 RRT setting: in ATSC digital TV mode, it could be adjusted

5.6 Reset RRT: Press ► button, the screen will be displayed as follow:

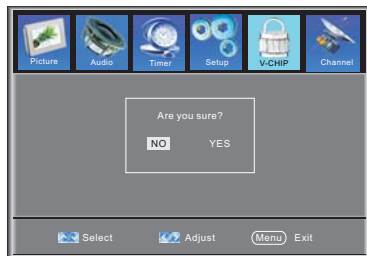

- A: Start to scan: press the ► button to confirm, you will see below menu which indicates auto search is in process.



6. Channel MENU

The sixth item of the MENU is Channel MENU. You can adjust digital and analogue TV Channel . Press ▼▲ to move, press ◀▶ to adjust here.

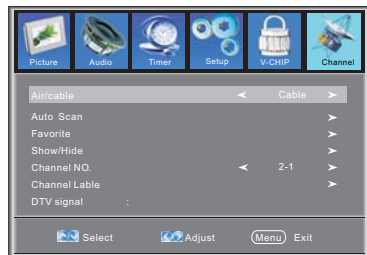

- 3). Favorite: Press ◀▶ button to choose/delete the favorite channel .
- 4). Show/Hide: Press ◀▶ button to display or hide currently channel.
- 5). Channel NO. :Display the currently channel number.
- 6). Channel lable: Press ▲▼button to edit currently channel name.
- 7). DTV signal: Display DTV signal intension. It can't be selected and adjusted.



Caution

The DVD video player is A class 1 laser product. Use of controls or adjustments or performance of procedures other than those specified herein. May result in hazardous radiation Exposure. As the laser beam used in this DVD video player. Is harmful to the eyes, do not attempt to disassemble the Cabinet. Refer servicing to qualified personnel only.

DVD SIDE PANEL

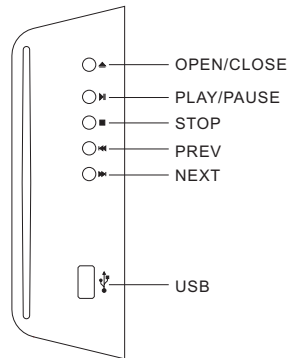

How to enter DVD source
Please press the SOURCE key and select the DVD item, then LCDTV will enter DVD mode.

USB
In DVD mode, press DVD/USB button in the remote controller, you can insert a USB disc or a Mp3 player with USB interface to play the mp3, JPEG and Mp4 files.

Caution:
When using USB function, please do not insert in the wrong direction, or else it will be damaged.

Features

Disc formats supported by this player:

 MPEG4 files on discs	 Dolby Digital
 DVD video	 MP3 files on CD-R/ CD-RW
 Subtitle choices	 Multi-angle
 TV Aspect Ratio modes	 Audio choices
 Parental Lock	

This product incorporates copyright protection technology that is protected by method claims of certain U.S. patents and other intellectual property rights owned by Macro vision Corporation and other rights owners. Use of this copyright protection technology must be authorized by Macro vision Corporation, and is intended for home and other limited viewing uses only unless otherwise authorized by Macro vision Corporation. Reverse engineering or disassembly is prohibited.

Manufactured under license from Dolby Laboratories. "Dolby" and the double-D symbol are trademarks of Dolby Laboratories. Confidential Unpublished Works. © 1992-1997 Dolby Laboratories, Inc. All rights reserved.

1. General Steps of setup menu

A) Press the setup button, the main setup menu appears.

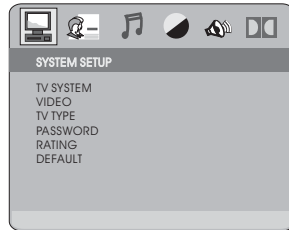

B) Press the Left and Right arrow buttons to highlight the icon of the desired page, then press the Down or Right arrow button to activate that page. For example, if you want to setup the video page, press Right to highlight the video icon, the video page will be displayed on the screen.

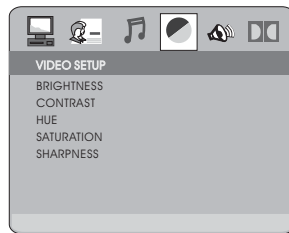

C) Press the Down arrow button to highlight the desired option. Press Enter or press Right to select. The choices of that option appear on the right. For example, press the Down arrow button to highlight the BRIGHTNESS option, then press Enter to select, the brightness choices appear on the right.



A) Press the Arrow buttons to highlight the Exit Setup option, then press Enter or Setup again to exit Setup Menu.

2. Setup Items Introduction

2.1 SYSTEM SETUP

The system setup options are illustrated below:

2.1.1 TV SYSTEM

According to the Color System of the TV, you can choose the TV System.

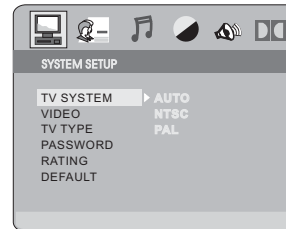

2.1.2 VIDEO

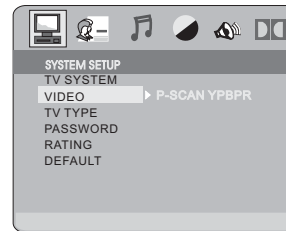

2.1.3 TV TYPE

According to the TV type, you can choose 16:9, 4:3LB or 4:3PS.

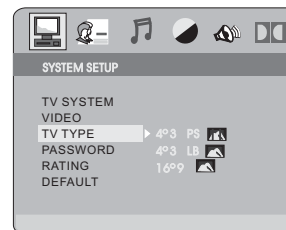

2.1.4 PASSWORD

The password option is initially locked, and you can not set the ratings limit or change the password. In order for the Ratings feature to work, the password mode must be turned on. If you want to set the ratings limit, you will need to enter the default password. Which is 6666. then press Enter to confirm. To change the password, you will be prompted for the old password, then be prompted for new one. Enter a 4-digit number (this is your password). Press remember your PASSWORD, as the DEFAULT setting will revert everything. But the PASSWORD to the factory defaults.

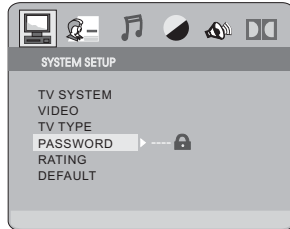

2.1.5 RATING

The Rating feature is a rating limit system, like movie ratings. It works with DVD discs that have been assigned a rating. This helps you control the types for DVDs that your family watches.

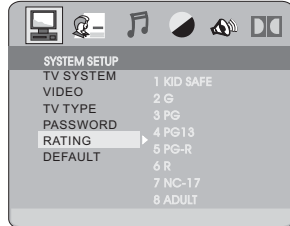

2.1.6 DEFAULT

The DEFAULT setup options are RESTORE factory setup. Let your player work on best state.

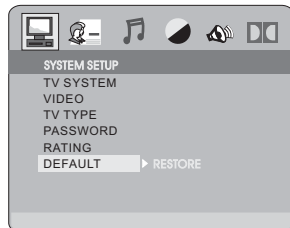

2.2 LANGUAGE SETUP

The language setup options are illustrated below:

2.2.1 OSD LANGUAGE

Highlight the OSD LANGUAGE option, and press the Arrow buttons to choose the OSD language you prefer. Press Enter to confirm, and it will display OSD in that language.

Note: The OSD LANGUAGE display is subject to sales country.



2.2.2 AUDIO LANG

Highlight the AUDIO LANG option, and press the Arrow buttons to choose the audio language you prefer. Press Enter to confirm. If the disc you are playing has that language available, it will output that language

Note: The AUDIO LANGUAGE display is subject to sales country..



2.2.3 SUBTITLE LANG

Highlight the SUBTITLE LANG option, and press the Arrow buttons to choose the subtitle language you prefer. Press Enter to confirm. If the disc you are playing has that language available, it will display subtitles in that language. Note: The SUBTITLE LANGUAGE display is subject to sales country..



2.2.4 MENU LANG

Highlight the MENU LANG option, and press the Arrow buttons to choose the menu language you prefer. Press Enter to confirm. If the disc you are playing has that Language available, it will display the menu in the language. Note: The MENU LANGUAGE display is subject to sales country..

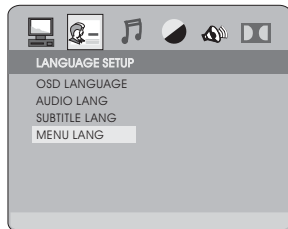

2.3 AUDIO SETUP



2.4 VIDEO SETUP

The video setup options are illustrated below:

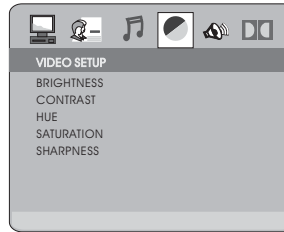

2.4.1 BRIGHTNESS

Use the Up and Down arrow buttons to move the scroll and adjust the brightness.



2.4.2 CONTRAST

Use the Up and Down arrow buttons to move the scroll and adjust the contrast.



2.4.3 HUE

Use the Up and Down arrow buttons to move the scroll and adjust the hue.

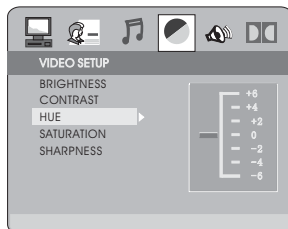

2.4.4 SATURATION

Use the Up and Down arrow buttons to move the scroll and adjust the saturation.



2.4.5 SHARPNESS

Use the Up and Down arrow buttons to move the scroll and adjust the Sharpness.

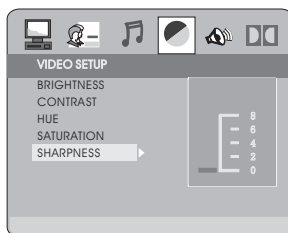

2.5 SPEAKER SETUP

The speaker setup options are illustrated below:

2.5.1 DOWNMIX

A)LT/RT Choose this setting when the DVD player is connected to a 2 Channel Analog Audio input.
 B)STEREO Choose this setting when the DVD player is connected to a TV or therefore modulator.



2.6 DIGITAL SETUP

The DIGITAL SETUP options are illustrated below:

2.6.1 DYNAMIC RANGE

When LINE OUT is selected,choose this setting to adjust the line out ratio for different effects.

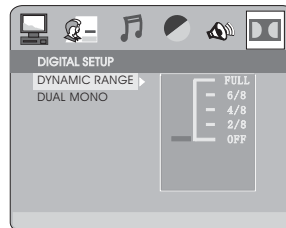

2.6.2 DUAL MONO (LEFT + RIGHT)

Choose to setup the L and R mono output mode. There are four modes in this option: STEREO, MONO L, MONO R, and MIN MONO.

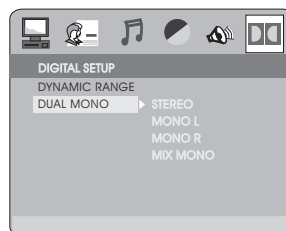

DVD REMOTE CONTROL OPERATION

0-9 keys

- These keys are used to input the time, as well as title, chapter and track numbers.
- When a numeric item is displayed on the screen, press the 0-9 keys to select the desired entry, and press ENTER to confirm.
- When a numeric item is larger than 9 press the GOTO key to select the display entry.

UP/DOWN/LEFT/RIGHT

- Used to navigate menus.

ENTER

- Pressing <ENTER> will enter the selected item in a menu.

SETUP

- Press SETUP during playback to pause playback.
- Press SETUP repeatedly to play frame.
- Press PLAY to resume normal playback.

RETURN

- During DVD playback, press RETURN to display the DVD title menu or play the first title.

Note: this function is subject to the disc.

PLAY/PAUSE

- Press PLAY/PAUSE from stop mode to start play.
- Press PLAY/PAUSE during playback to pause playback.
- Press PLAY/PAUSE to resume normal playback.

REV

- During DVD or CD playback, press and hold  to scan in reverse. The player will review the disc at 2, 4, 8 and 20 times normal speed as follows:

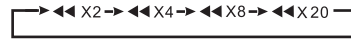

Press PLAY to resume normal playback.

FWD

- During DVD or CD playback, press and hold  to scan forward. The player will review the disc at 2, 4, 8 and 20 times normal speed as follows:

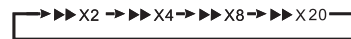

Press PLAY to resume normal playback.

MENU

- During DVD, playback, press MENU to return to the program menu.

Note: This function is subject to the disc.

AUDIO

During DVD playback

- Press AUDIO repeatedly to select from up to 8 Audio language/formats.

Note: This function is disc specific.

DVD REMOTE CONTROL OPERATION

GOTO

During playback, press GOTO show the current time counter position.

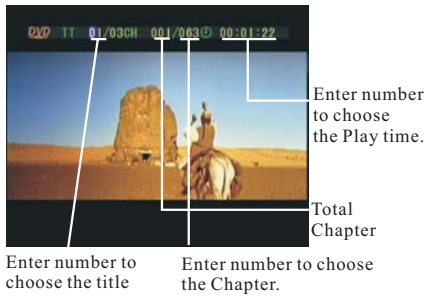

DVD/USB

Switch between disc and USB operation.

OPEN/CLOSE

- To open the disc tray, press OPEN/CLOSE.
- To close the disc tray, press OPEN/CLOSE again.

STOP

- Press STOP once during playback to stop and hold playback.
- Press PLAY to resume playback from the point you pressed STOP.
- Press STOP twice to stop playback completely.

38:NEXT

- Press NEXT to skip to the next chapter or track.

PREV

- Press PREV to skip to previous chapter or track.

DISPLAY

- During playback, press DISPLAY to show the current time counter position.

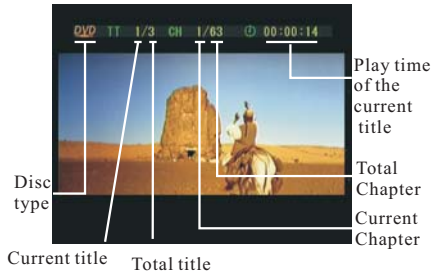

Press DISPLAY to show the Audio and Subtitle message menu.



SUBTITLE

During DVD playback

- Press SUBTITLE repeatedly to select from up to 32 subtitle languages.

Note: This function is disc specific.

Mp3 PLAYBACK

When a MPEG and a Mp3 disc is loaded, the screen will be displayed as follows:

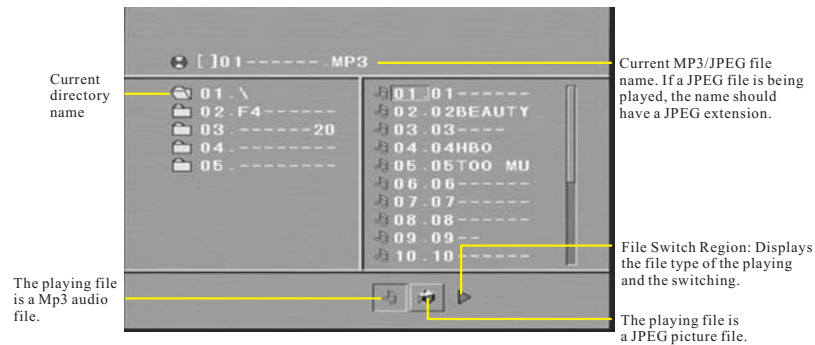

Press \square to select the file when the cursor appears in the file window.
 Press \square to play the current file selected by the cursor.
 Press \square to switch between the directory window and the file window.

Note:

During Mp3 playback, Forward Scan and Reverse Scan are not available.

Note:

The player will not identify or play a MP3 disc under the following conditions: the recording format is not supported(make sure the files are in MP3 format),the disc is badly scratched, damaged or dirty, the disc is not finalised.

DVD Trouble shooting

If you have any questions, please consult the troubleshooting guide below:

NO PICTURE OR SOUND

- Ensure the power button is on.
- Ensure the power outlet is operational.
- Ensure the power cord is not damaged.
- Ensure the power plug is connected firmly to the outlet.

PICTURE BUT NO SOUND

- Ensure the audio is not set to mute.
- Ensure you have set the player's AUDIO settings correctly.

POOR PICTURE OR SOUND

- Ensure you have set the player's AUDIO settings correctly.
- Ensure the disc is not scratched or stained.

"BAD DISC" DISPLAYED

- Ensure the disc is not warped, damaged or deformed.
- Ensure the disc is not badly stained or damaged.
- Ensure the disc format is compatible with the player.
- Please check whether you have tried to play a software CD. If so, please restart the player.

REMOTE NOT WORKING

- Make sure the Main unit's POWER button is on.
- Ensure the remote batteries are working.
- Point the remote control directly at the player's IR sensor.
- Remove any obstacles between the remote and the IR sensor.

















UNIT NOT WORKING

- Turn off the power, and then turn it on again.

"NO DISC" DISPLAYED

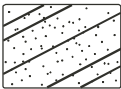
- Ensure you have put the disc on the tray.
- Ensure the disc is not upside down.
- Ensure the disc is not distorted, stained or scratched.

Trouble shooting

Trouble phenomenon Symptom		Inspection Check
Picture	Audio	
 Snow	 Noise	antenna position, direction or connection
 Ghost	 Normal audio	antenna position, direction or connection
 Interference	 Noise	electronic equipment, car/ motorcycle, fluorescent light
 Normal Picture	 Mute	Volume (check if mute is activated or if the audio system connections are not correct)
 No picture	 Mute	Power cord is not inserted Power switch is not opened Contrast and brightness/volume setup Press standby key on the remote control for inspecting
 No colour	 Normal audio	Colour control
 Picture breaking up	 Normal audio or weak	retune channel
 No colour	 Noise	TV system

The LCDTV panel is built with very high precision technology giving you fine picture details in vibrant color. Occasionally, a few non-active pixels may appear on the screen as a fixed point of red, green, blue, black or white. Please note this does not affect the performance of the product.



This symbol on the product or in the instructions means that your electrical and electronic equipment should be disposed at the end of life separately from your household waste. There are separate collection systems for recycling in the EU. For more information, please contact the local authority or your retailer where you purchased the product.