

ViewSonic®

CD3200

LCD Commercial Display

- User Guide
- Guide de l'utilisateur
- Bedienungsanleitung
- Guía del usuario
- Guida dell'utente
- Gebruikshandleiding



ViewSonic®

Model No. : VS11857

Contents

Compliance Information.....	1
Important Safety Instructions.....	2
Declaration of RoHS Compliance.....	3
Copyright Information.....	4
Product Registration.....	4
SAFETY AND PRECAUTIONS.....	5
OPERATING SAFETY.....	5
REPAIR.....	6
Notes for Service Engineers.....	6
Point of use.....	7
Environmental conditions.....	7
Connecting.....	8
PRECAUTIONS.....	9
IMPORTANT ADDITIONAL SAFETY INSTRUCTIONS.....	9
INTRODUCTION.....	10
SERVICE.....	10
PERFORMANCE CHARACTERISTICS.....	10
INCLUDED EQUIPMENT.....	12
CONNECTING EXTERNAL DEVICES.....	13
CONTROLS AND LOCATION.....	14
REMOTE CONTROL.....	15
SUMMARY OF REMOTE CONTROL BUTTONS.....	16
CONNECTIONS & APPLICATIONS.....	17
GENERAL CONTROLS & ADJUSTMENT.....	21
TURNING THE LCD DISPLAY ON AND OFF.....	21
VOLUME CONTROL.....	21
SETTING THE SLEEP TIMER.....	21
SWITCHING PC / HDMI / VIDEO / SCART MODES.....	22
VIEWING THE MENUS AND ON-SCREEN DISPLAYS.....	23
PICTURE SETTING.....	24
SOUND ADJUSTMENT.....	27
FUNCTION.....	32
PC MENU.....	37

OTHER FUNCTIONS..... 40
TROUBLESHOOTING..... 41
PC INPUT PRESET TIMING TABLE..... 43
SPECIFICATIONS 44
Customer Support..... 45
Limited Warranty 46

Compliance Information

Warning: You are cautioned that changes or modifications not expressly approved by the party responsible for compliance could void your authority to operate the equipment.

For Canada

This Class B digital apparatus complies with Canadian ICES-003.

Cet appareil numérique de la classe B est conforme à la norme NMB-003 du Canada.

CE Conformity for European Countries



The device complies with the requirements of the EEC directive 89/336/EEC as amended by 92/31/EEC and 93/68/EEC Art.5 with regard to "Electromagnetic compatibility", and 73/23/EEC as amended by 93/68/EEC Art.13 with regard to "Safety."

Following information is only for EU-member states:

The mark shown to the right is in compliance with the Waste Electrical and Electronic Equipment Directive 2002/96/EC (WEEE).

The mark indicates the requirement NOT to dispose the equipment as unsorted municipal waste, but use the return and collection systems according to local law.



Important Safety Instructions

1. Read these instructions completely before using the equipment.
2. Keep these instructions in a safe place.
3. Heed all warnings.
4. Follow all instructions.
5. Do not use this equipment near water. Warning: To reduce the risk of fire or electric shock, do not expose this apparatus to rain or moisture.
6. Clean with a soft, dry cloth. If further cleaning is required, see “Cleaning the Display” in this guide for further instructions.
7. Do not block any ventilation openings. Install the equipment in accordance with the manufacturer’s instructions.
8. Do not install near any heat sources such as radiators, heat registers, stoves, or other devices (including amplifiers) that produce heat.
9. Do not attempt to circumvent the safety provisions of the polarized or grounding-type plug. A polarized plug has two blades with one wider than the other. A grounding type plug has two blades and a third grounding prong. The wide blade and the third prong are provided for your safety. If the plug does not fit into your outlet, consult an electrician for replacement of the outlet.
10. Protect the power cord from being tread upon or pinched, particularly at the plug, and the point where it emerges from the equipment. Be sure that the power outlet is located near the equipment so that it is easily accessible.
11. Only use attachments/accessories specified by the manufacturer.
12. Use only with the cart, stand, tripod, bracket, or table specified by the manufacturer, or sold with the equipment. When a cart is used, use caution when moving the cart/equipment combination to avoid injury from tipping over.
13. Unplug this equipment when it will be unused for long periods of time.
14. Refer all servicing to qualified service personnel. Service is required when the unit has been damaged in any way, such as: if the power-supply cord or plug is damaged, if liquid is spilled onto or objects fall into the unit, if the unit is exposed to rain or moisture, or if the unit does not operate normally or has been dropped.



Declaration of RoHS Compliance

This product has been designed and manufactured in compliance with Directive 2002/95/EC of the European Parliament and the Council on restriction of the use of certain hazardous substances in electrical and electronic equipment (RoHS Directive) and is deemed to comply with the maximum concentration values issued by the European Technical Adaptation Committee (TAC) as shown below:

Substance	Proposed Maximum Concentration	Actual Concentration
Lead (Pb)	0.1%	< 0.1%
Mercury (Hg)	0.1%	< 0.1%
Cadmium (Cd)	0.01%	< 0.01%
Hexavalent Chromium (Cr ⁶⁺)	0.1%	< 0.1%
Polybrominated biphenyls (PBB)	0.1%	< 0.1%
Polybrominated diphenyl ethers (PBDE)	0.1%	< 0.1%

Certain components of products as stated above are exempted under the Annex of the RoHS Directives as noted below:

Examples of exempted components are:

1. Mercury in compact fluorescent lamps not exceeding 5 mg per lamp and in other lamps not specifically mentioned in the Annex of RoHS Directive.
2. Lead in glass of cathode ray tubes, electronic components, fluorescent tubes, and electronic ceramic parts (e.g. piezoelectronic devices).
3. Lead in high temperature type solders (i.e. lead-based alloys containing 85% by weight or more lead).
4. Lead as an alloying element in steel containing up to 0.35% lead by weight, aluminium containing up to 0.4% lead by weight and as a copper alloy containing up to 4% lead by weight.

Copyright Information

Copyright © ViewSonic® Corporation, 2007. All rights reserved.

Macintosh and Power Macintosh are registered trademarks of Apple Computer, Inc. Microsoft, Windows, Windows NT, and the Windows logo are registered trademarks of Microsoft Corporation in the United States and other countries.

ViewSonic, the three birds logo, OnView, ViewMatch, and ViewMeter are registered trademarks of ViewSonic Corporation.

VESA is a registered trademark of the Video Electronics Standards Association. DPMS and DDC are trademarks of VESA.

ENERGY STAR® is a registered trademark of the U.S. Environmental Protection Agency (EPA).

As an ENERGY STAR® partner, ViewSonic Corporation has determined that this product meets the ENERGY STAR® guidelines for energy efficiency.

Disclaimer: ViewSonic Corporation shall not be liable for technical or editorial errors or omissions contained herein; nor for incidental or consequential damages resulting from furnishing this material, or the performance or use of this product.

In the interest of continuing product improvement, ViewSonic Corporation reserves the right to change product specifications without notice. Information in this document may change without notice.

No part of this document may be copied, reproduced, or transmitted by any means, for any purpose without prior written permission from ViewSonic Corporation.

Product Registration

To meet your future needs, and to receive any additional product information as it becomes available, please register your product on the Internet at:

www.viewsonic.com. The ViewSonic Wizard CD-ROM also provides an opportunity for you to print the registration form, which you may mail or fax to ViewSonic.

For Your Records

Product Name:	CD3200 ViewSonic 32" LCD Commercial Display
Model Number:	VS11857
Document Number:	CD3200-1_UG_ENG Rev. 1A 05-23-07
Serial Number:	_____
Purchase Date:	_____

Product disposal at end of product life

The lamp in this product contains mercury. Please dispose of in accordance with local, state or federal laws.

ViewSonic is concerned about the preservation of our environment. Please dispose of this product properly at the end of its useful life. For the recycling information, please refer to our website:

1. USA: www.viewsonic.com/pdf/RecyclePlus.pdf
2. Europe: www.viewsoniceurope.com
3. Taiwan: recycle.epa.gov.tw

1. SAFETY AND PRECAUTIONS

Please read through this section carefully and follow the instructions to maximize the reliable operation and lifetime of your LCD display. Always keep these instructions handy and close by your LCD display. Keep the instructions and the packaging so that if you sell or give away your LCD display you can give them to the new owner.

OPERATING SAFETY



- **Never open the housing** of the LCD display /power supply! When the housing is open there is a **danger of injury** from electric shock!

- Do not insert **any objects** through the slots and openings of the monitor. This may lead to an electrical short-circuit or even fire resulting in damage to your LCD display.



- Slots and openings in the LCD display are for ventilation purpose. **Do not cover these openings**, as this may lead to overheating.
- Do not allow **children** to play **unattended** with electrical equipment. Children may not always correctly recognize danger.
- This LCD display is intended for personal use only. It **not** intended for commercial use in a **heavy industry environment**.
- An **injury hazard** exists when the **display breaks**. Wear protective gloves to pack the broken parts and send them into your service centre for proper **disposal**. Then wash your hands with soap, because it is possible for **chemicals** to escape.
- Never exert pressure on the display. This could break the monitor.
- Do not touch the display with your fingers or with sharp objects to avoid damage.

Contact the Call Centre immediately in any of the following situations. Do NOT plug in or turn on your display:

- ◆ if the power cable/power supply overheats or is damaged
- ◆ if liquid has got into the monitor
- ◆ if the LCD display is dropped or the housing damaged

REPAIR

- Leave all repairs of your LCD display to **authorised and qualified personnel** only.
- Should a repair be necessary, please contact one of our authorized **service partners** only.

NOTES FOR SERVICE ENGINEERS

- Before opening the housing, **disconnect the product from all power sources and remove any connecting cables**. If the display has not been disconnected from the power outlet before being opened, there is a **danger to life** through electric shock. There is also a risk of damage to the components.
- Internal components of the LCD display may be damaged by electrostatic discharge (ESD). Carry out repairs in an ESD-protected workshop. If no such workshop is available, wear an antistatic wrist strap or touch a highly conductive metal object. We can repair damage sustained by inappropriate handling for a fee.
- Use only original spare parts.

POINT OF USE

- Keep your LCD display and all units connected to it away from **moisture** and avoid **dust, heat** and **direct sunlight**. Failure to observe these instructions can lead to malfunctions or damage to the LCD display.
- Place and operate all units on a **stable, level** and **vibration-free surface** in order to avoid the LCD display from falling.

ENVIRONMENTAL CONDITIONS

- The LCD display can be operated most reliably at ambient temperatures between **+41°F** and **+95°F** (5° C to 35° C) and at a relative humidity between 20% and 85% (without condensation).
- When switched off, the LCD display can be stored most reliably between **-4°F** and **+140°F** (-20° C - +60° C), up to the maximum height of 39,000 ft (12,000 m) above sea level at a relative humidity between 10% and 85% (without condensation).
- After transporting your LCD display please wait until it has assumed the ambient temperature before connecting and switching it on. Extremely high variations in the temperature or humidity may result in **condensation** forming on the inside of the LCD display which could cause an **electrical short-circuit**.

CONNECTING

Observe the following instructions to connect your LCD display properly:

POWER SUPPLY



- Do not open the power supply housing. An open housing presents a **lethal hazard** from electrical shock. There are no parts inside to be cleaned or serviced.
- Operate your LCD display only with grounded outlets with **AC 100-240V~/50-60 Hz**. If you are not sure about the power supply at your location, check with your power company.
- Use only the power supply and power connection cable **provided**.
- For additional safety we recommend use of a **surge protector** to protect your LCD display from damage resulting from **voltage surges** or **lightning**.
- To remove the LCD display from the power supply, disconnect the plug from the AC outlet.
- The power **outlet** must be in the vicinity of your LCD display and within reach of the power cables. **DO NOT stretch the power cables tightly to reach a power outlet.**
- You should arrange the LCD display cables in a manner that no one can trip over or step on them.
- To avoid damage of cable **do not place any objects or furniture on the cable.**

PRECAUTIONS

Caution! There are **no parts which can be serviced** or cleaned inside of the display housing.

You can increase the life of your LCD display by taking the following precautions:

- Before cleaning **always disconnect the power line** and all connection cables.
- Do **not use any solvents**, caustic or gaseous cleaning agents.
- Clean the display with a soft, lint-free cloth.
- Ensure that no water droplets remain on the screen. Water can cause **permanent discoloration**.
- Do not expose the screen to **bright sunlight** or **ultraviolet radiation**.

2. INTRODUCTION

Thank you for purchasing our LCD Multi-display. We thank you for your confidence in our products and are pleased to greet you as a new customer.

We focused on great features, ease of use and reliability in manufacturing your LCD display.

SERVICE

Your display comes with a one-year warranty, this is in addition to your statutory rights.

This manual contains a separate chapter on Troubleshooting on page 37.

PERFORMANCE CHARACTERISTICS

Advantages in relation to CRT (cathode ray tube) displays:

- Less space required
- Lighter weight
- Lower power consumption

Further features

- Multi-sources input included D-SUB, HDMI, SCART 1, SCART 2, SCART 2 S, COMPONENT, VIDEO , and S-VIDEO.
- Easy-to-use remote control, and OSD (on-screen display) menu.
- Experience PIP (picture in picture) and POP (picture of picture; Split Screen.)
- Aspect Ratio modes include Full, Panoramic, Normal, Zoom 1, and Zoom 2.
- APC (auto picture control) settings include Movie, Bright, Manual and Standard.
- Automatic sleep timer control from 10 to 120 minutes in 10-minute increments.
- Automatic Power Off feature after 10 minutes without a signal.
- Provided component video input for high definition LCD (HD ready), resolution up to 720p, 1080i
- Provided 6 Equalizer modes for selection.

RS232 Protocol

One of the instinct features of CD3200 is the RS232 protocol. The CD3200 can be controlled thorough the serial port from a PC. The release of the RS232 protocol will base on Viewsonic release notes.

The Viewsonic_RS232_protocal document defines the command code and format of the RS232 protocol.

INCLUDED EQUIPMENT

Please check that you have received the following items with your LCD unit.

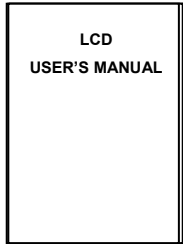

User's Manual



Remote Control & Batteries(AAA X2)



Power Cord

3.CONNECTING EXTERNAL DEVICES

Interface I

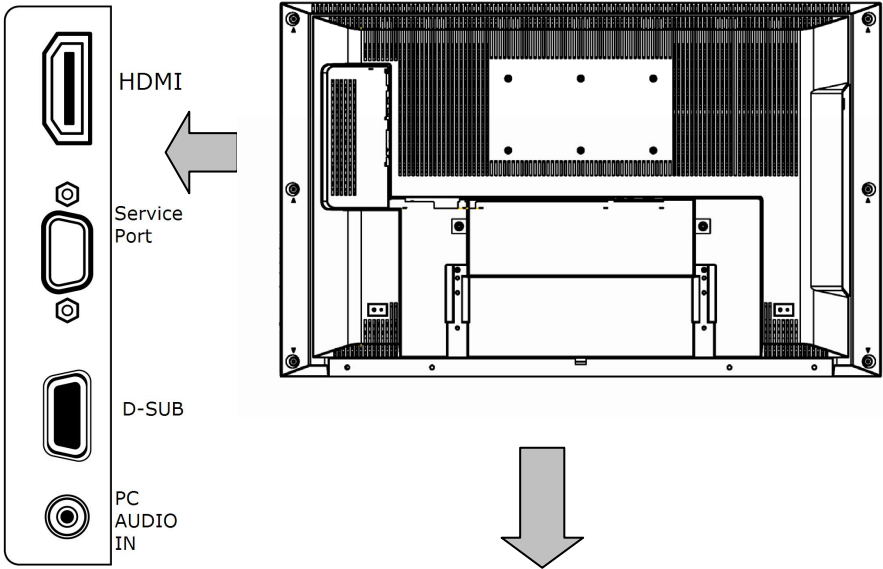

Interface II

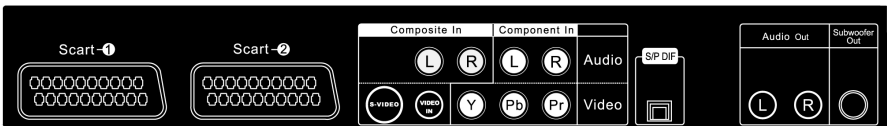

Note: Audio out L/R

The level of audio output cannot be changed using the volume control on your display. This connector should be used with an external audio amplifier that can be used to control the volume.

4. CONTROLS AND LOCATION

Turn The LCD Display On

Plug the power cable into the AC-in socket located on the left rear of the LCD. Plug the other end into an electrical socket. Press the power button on the remote control or right side to turn the LCD on .

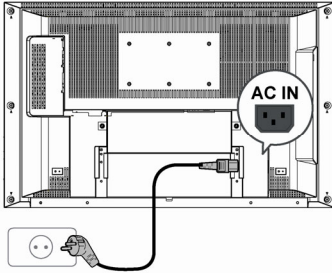

Function Key

These buttons control your LCD unit's basic features, including the on-screen menu. To use the more advanced features, you must use the remote control.

- POWER : Turn on or turn off the LCD unit.
- SOURCE : Select input source (PC, HDMI, AV, SV, YBPBR, SCART 1, SCART 2, SCART 2S).
- MENU : Display the main menu.
- VOLUME (-/+) : Turn up or turn down the volume.
- EXIT / ARC : Set up the aspect ratio of display (Video source: Panorama, Normal, Full, Zoom1, Zoom2; PC source: Full, Normal) or as exit function if OSD menu appear. When in **OSD (On-Screen Display)** menu, press **EXIT / ARC** to close the OSD menu

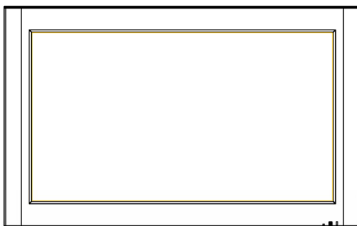

- EXIT/ ARC
- VOLUME
- CHANNEL
- MENU
- SOURCE
- POWER

Power indicator:
A green indicator lights when the power is on and an amber indicator lights when in the standby mode. A red indicator lights when the power is off.

Remote control sensor:
Remote control sensor that receives the remote control signals.

5.REMOTE CONTROL

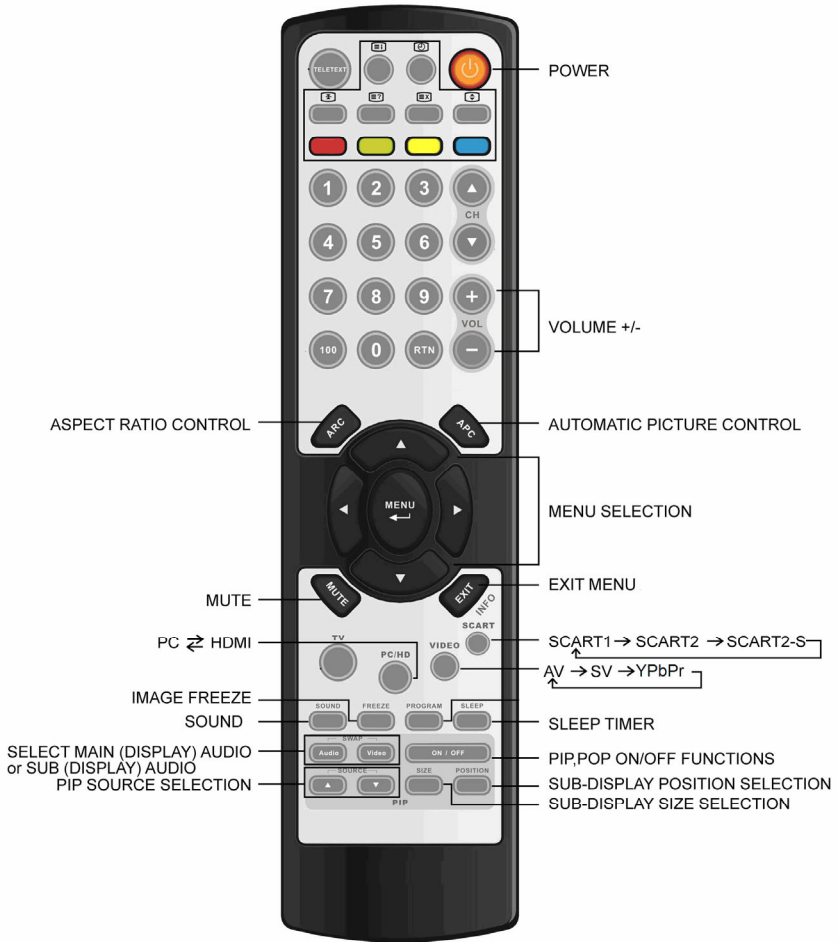

6.SUMMARY OF REMOTE CONTROL BUTTONS

Power control

POWER button Turn the LCD on or off.

Selecting the primary signal source

PC/HD button Switch to PC , HDMI mode.

VIDEO button Switch to AV / S-Video and YPBPR mode.

SCART Switch to SCART 1 / SCART 2 and SCART 2S mode.

Menu Settings

MENU button Display the on-screen menu.

EXIT Exit a menu or sub-menu.

△ / ▽ / ◀ / ▶ Access menu items.

Sound Control

VOL△/▽ button Increase/ Decrease volume level.

MUTE button Temporarily turn off audio.

PIP Control

PIP ON/OFF button Enable/Disable PIP viewing window.
Toggle PIPmode : PIP → POP → OFF.

△/▽ button Select PIP input source: PC→HDMI→AV→SV→SCART 1→
SCART 2→SCART 2S→YPBPR→PC.

SIZE button Toggle PIP window size: Small / Middle / Large.

Audio/Video button Toggle audio/video source between the primary display and the
PIP window.

POSITION button Move the PIP window position .

Other Function

INFO button Display current /Input source/signal format.

ARC button (Aspect Ratio Control) In PC mode : Set the picture mode to Full, Normal.
In Video mode : Toggle the picture mode between Normal →

APC button (Automatic Picture Control) Toggle screen luminosity between Standard, Movie, Bright, Manual

SLEEP button Select a pre-set time for automatic power down.

FREEZE button Temporary pause current image.

7. CONNECTIONS & APPLICATIONS

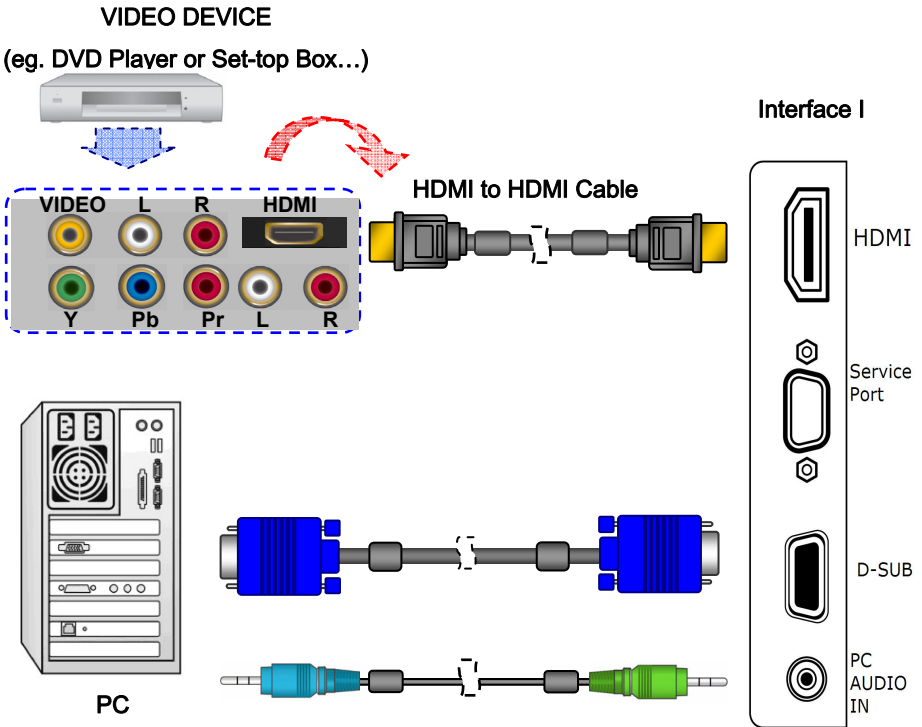

Note: 1. No sound connector is needed for a HDMI to HDMI connection.
2. HDMI and VGA cables are not supplied.

* How do I connect a Video device via HDMI - HDMI ?

This can be applied only if there is the HDMI Output connector on the external device.

Note: 1. No sound connector is needed for a HDMI to HDMI connection.

2. Connecting cables above are not supplied.

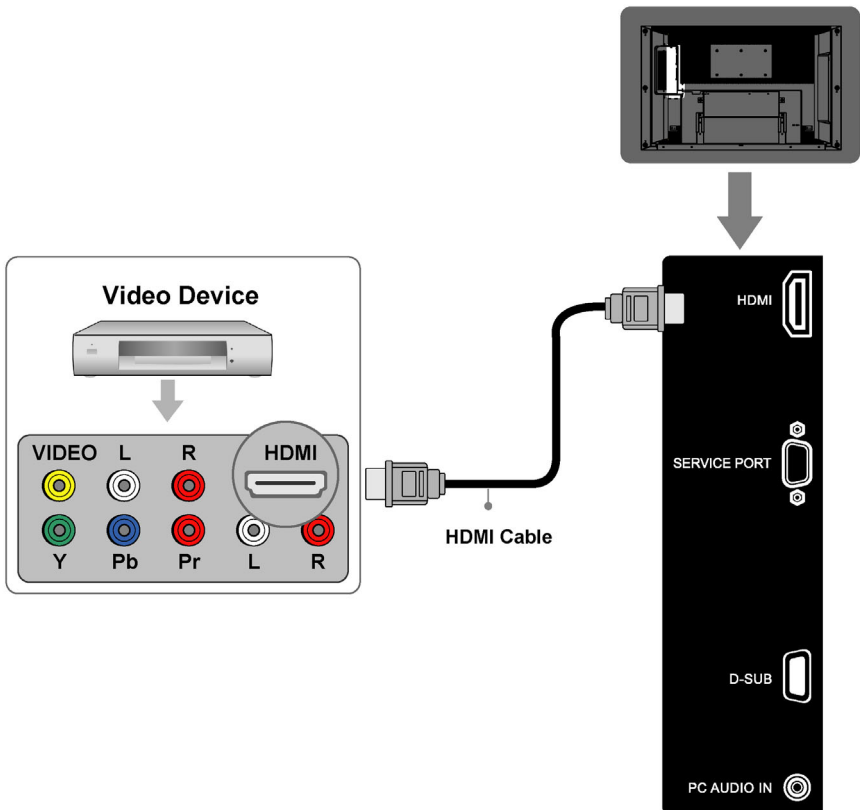

* How do I connect a PC via D-SUB ?

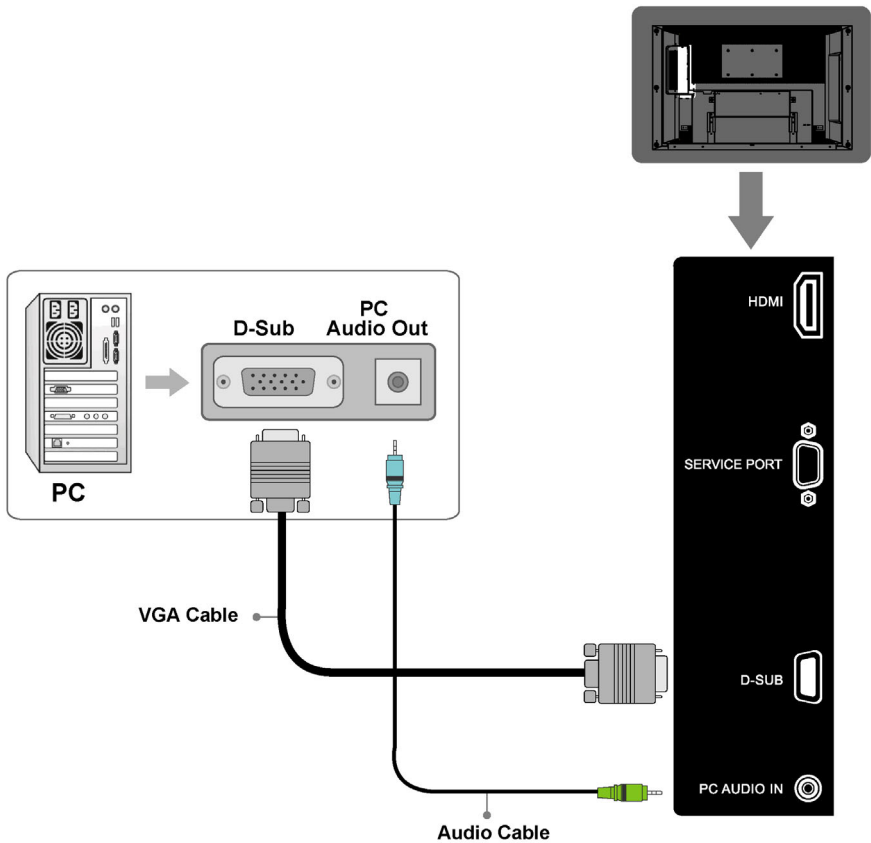

1. Connect a VGA cable between the D-SUB connector on the LCD and the D-SUB connector on PC.
2. Connect an audio cable between the PC AUDIO IN jack on the LCD and AUDIO OUT jack on PC.
3. Cables are not included.

*** How do I connect a video device via general cables?**

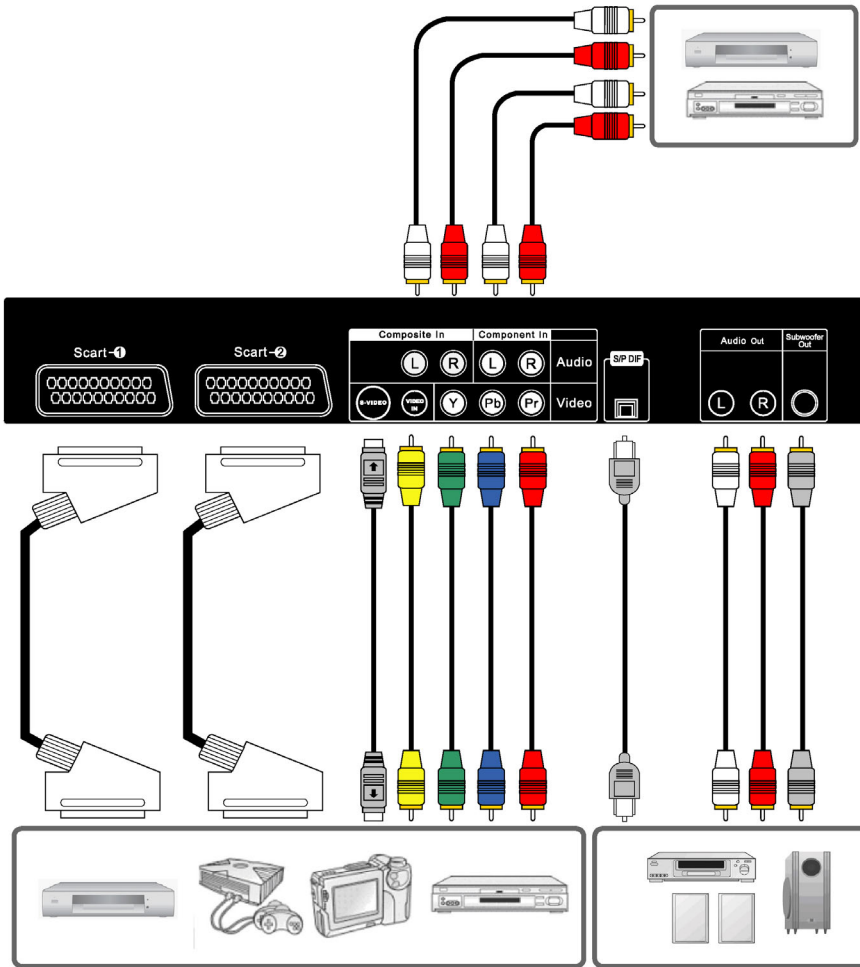

This LCD accepts different video input, if video device has a connector with better quality, please connect the better one. The sequence of video quality from the best to the normal is Component, Scart, S-Video.

Note: Cables are not supplied.

8. GENERAL CONTROLS & ADJUSTMENT

TURNING THE LCD DISPLAY ON AND OFF

1. Press the **POWER** button on the Remote Control.
2. You can also use the **POWER** button at the right of the panel.

VOLUME CONTROL

Using Volume Control

Press **VOL▲ / VOL▼** button to turn up or turn down the sound volume.

Using Mute

At any time, users can temporarily turn off the sound by pressing the **MUTE** button.

1. Press the **MUTE** button and the sound cuts off.
2. Press the **MUTE** again or **VOL▲ / VOL▼** button to turn the sound back to the previous level.

SETTING THE SLEEP TIMER

You can set the Sleep Timer to turn off the LCD automatically. The time can be set from OFF to 120 minutes.

1. Press the **SLEEP** button to set the Sleep Timer screen.
2. Press the **SLEEP** button repeatedly to change the sleep time (in 10 minutes intervals).

SWITCHING PC / HDMI / VIDEO / SCART MODES

1. Turn on the power.
2. Select an input source as described below:

PC/HD button switch to PC , HDMI mode

VIDEO button switch to AV / SV / YPBPR mode
(Composite, Y/C and Component signal)

SCART button switch to SCART 1, SCART 2, SCART 2S

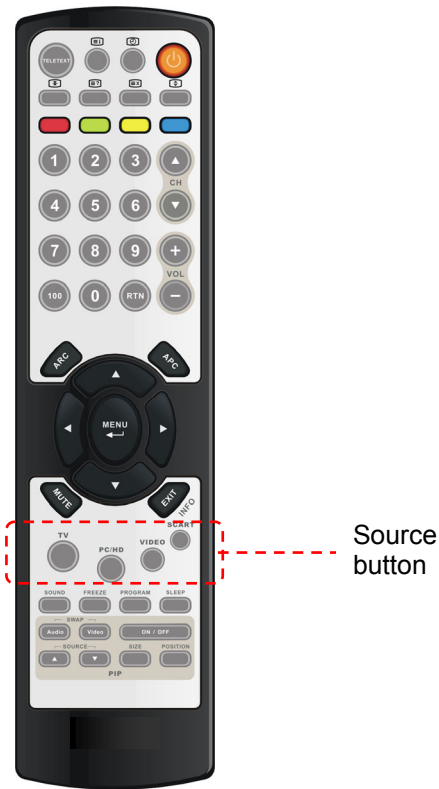

VIEWING THE MENUS AND ON-SCREEN DISPLAYS

1. With the power on, press the **MENU** button. The main menu appears on the screen.

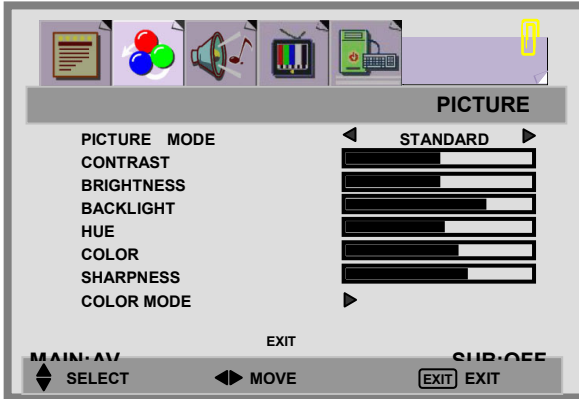

2. Use the ◀ / ▶ button to select one of the menu options, and then press the ▲ / ▼ button to access the sub-menu.
3. Press the ◀ / ▶ button to make adjustments.
4. Press EXIT/INFO button to exit from the menu.

Note: The menu varies according to which input source is selected.

PICTURE SETTING

You may need to perform separate adjustments for brightness and contrast for the different video modes. Typically, PC mode will be best viewed with lower brightness and contrast settings than are appropriate for the other modes.

1. Press the **MENU** button to display PICTURE from the main menu.
2. Press the **▲ / ▼** button to select the desired item.
3. Press the **◀ / ▶** button to adjust ranges from minimum to maximum.
4. Press the **EXIT/INFO** button to return to the previous screen.

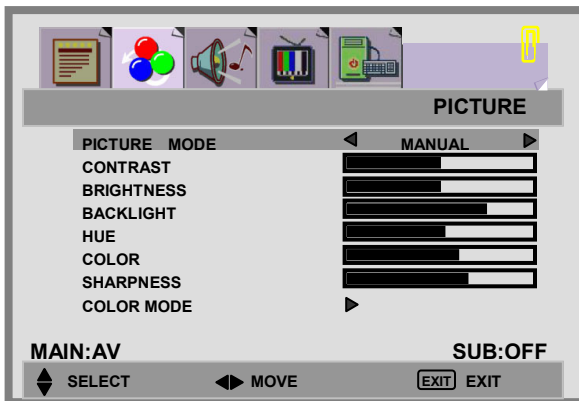

PICTURE MODES:

- **[MANUAL]**: Select this mode if you want to manually adjust each setting. Adjustments are only available under this mode.
- **[STANDARD]**: Standardizes picture adjustment
- **[MOVIE]**: Heighten contrast and sharpness
- **[BRIGHT]**: Display a clear and bright picture.

PICTURE SETTINGS:

CONTRAST: Increase and decrease picture contrast

BRIGHTNESS: Adjust picture brightness

BACKLIGHT: Adjust the back light level of screen

HUE:

COLOR: Adjust picture color

SHARPNESS: Adjust image

COLOR MODE:

1. Press the ▲ / ▼ buttons to select COLOR MODE option, and then press the ► button to enter the COLOR TEMP. sub-menu.

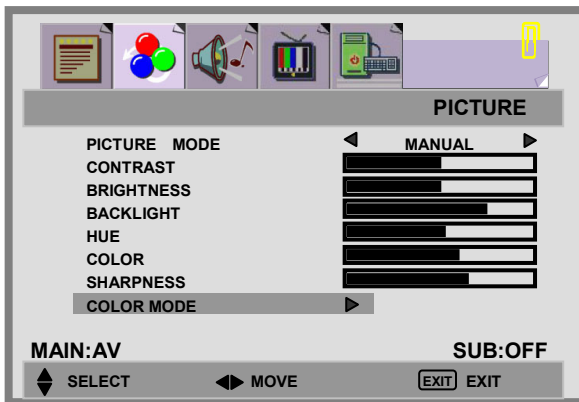

2. Press the ► button to choose the color of picture mode. [NORMAL], [WARM], [COOL], [MANUAL]. Users can adjust Color R/G/B only in [Manual].

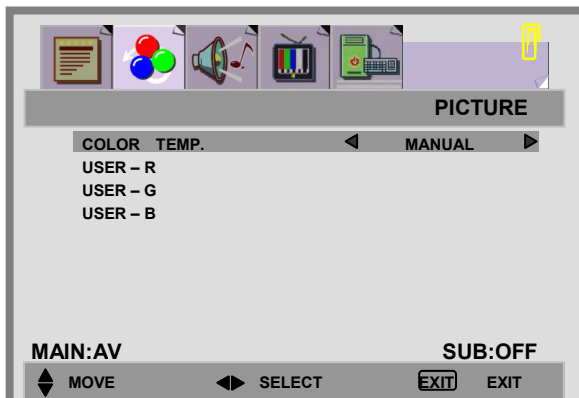

3. Press ▲ / ▼ buttons to move USER-R/G/B and then press the ► button to enter the desired setting.

USER-R: adjust color of red rate.

USER-G: adjust color of green rate.

USER-B: adjust color of blue rate.

SOUND ADJUSTMENT

1. Press the **MENU** button to display **SOUND** from the main menu.
2. Press the **▲ / ▼** button to move to one of the sub-menu options.
3. Press the **◀ / ▶** button to select the settings.
4. Press the **EXIT/INFO** button to return to the previous screen.

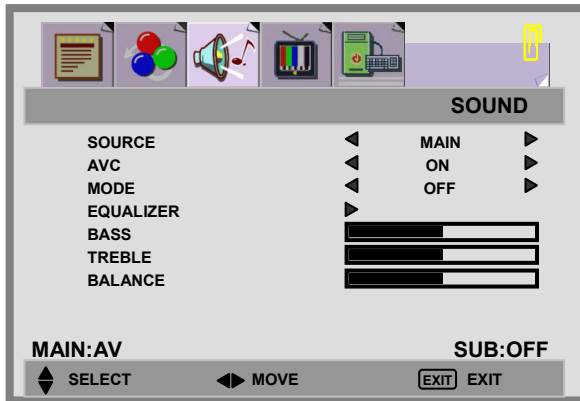

SOURCE: Choose the sound source from the [MAIN] or [SUB] display. You can enable this function while in PIP (picture in picture) or POP (picture of picture).

AVC: You can set AVC (Auto Volume Control) options to ON or OFF.

[ON]: For general use, like commercial advertisement, AVC can avoid the sound turns up or down suddenly.

[OFF]: For special sound effect, like opera or symphony, volume can be performed in accordance with the original sound level.

MODE: Select the audio mode to [OFF], [EQ].

[In OFF mode]

BASS: Adjust low tone of sound.

TREBLE: Adjust high tone of sound.

BALANCE: Adjust the volume balance between the left and right speakers.

[In EQ mode] (EQ is shortened for Equalizer).

BALANCE: Adjust the volume balance between the left and right speakers.

EQUALIZER:

1. Press the ▲ / ▼ button to enter the EQUALIZER menu.

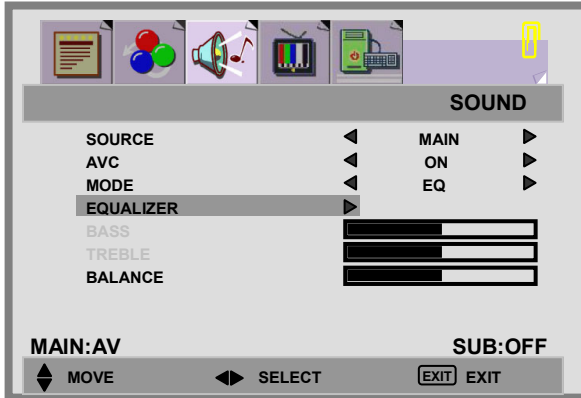

2. Press the ► button to select the EQUALIZER options.

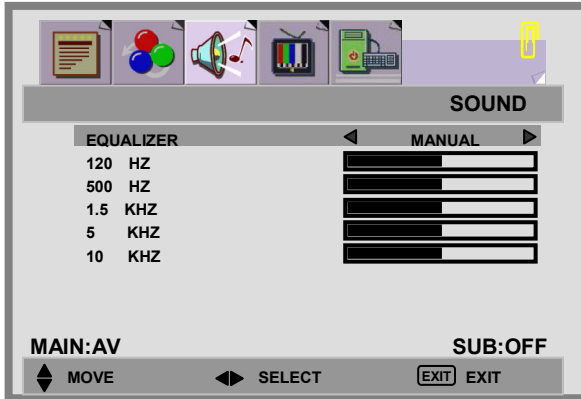

3. There are 6 Equalizer modes available: [MANUAL], [VOICE], [POP], [ROCK], [JAZZ], [CLASSIC].

4. Settings for VOICE, POP, ROCK, JAZZ and CLASSICAL are pre-configured. You cannot adjust these settings. The frequency responses are as below:

Note: Functions in grey are preconfigured.

VOICE:

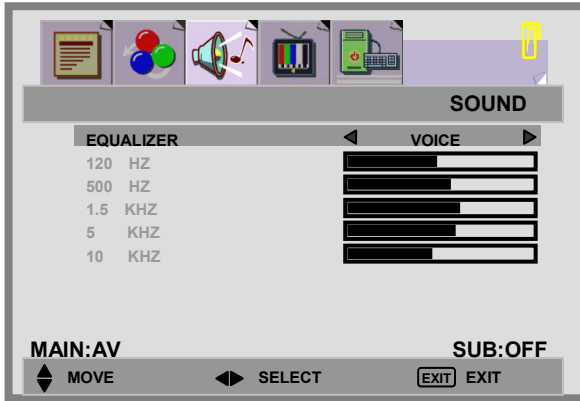

POP:

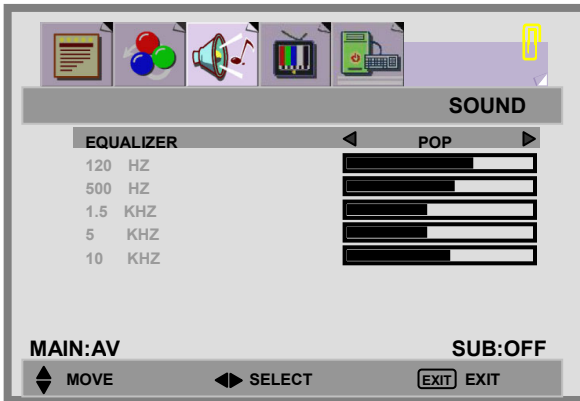

ROCK:

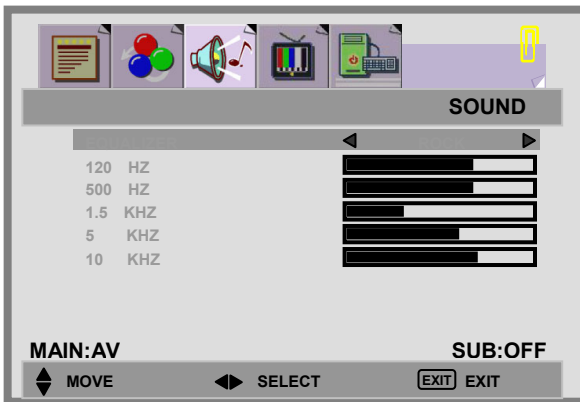

Note: Functions in grey are preconfigured.

JAZZ:

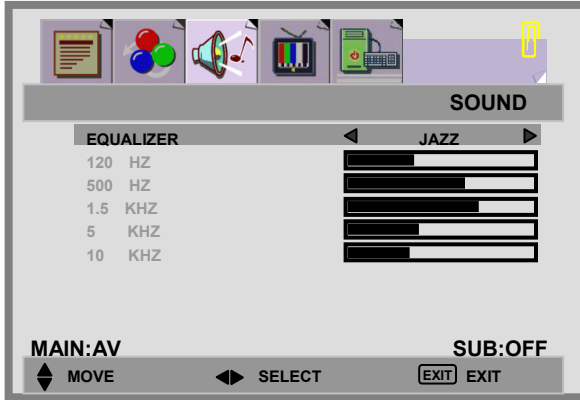

CLASSICAL:

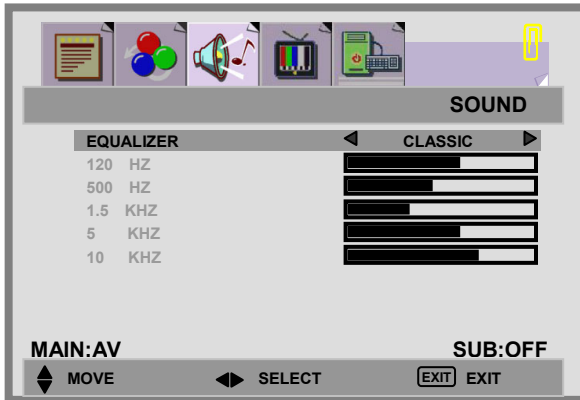

Note: Functions in grey are preconfigured.

5. In MANUAL mode, press ▲ / ▼ buttons to the band and press ◀ / ▶ buttons to select the desired frequency settings.

MANUAL:

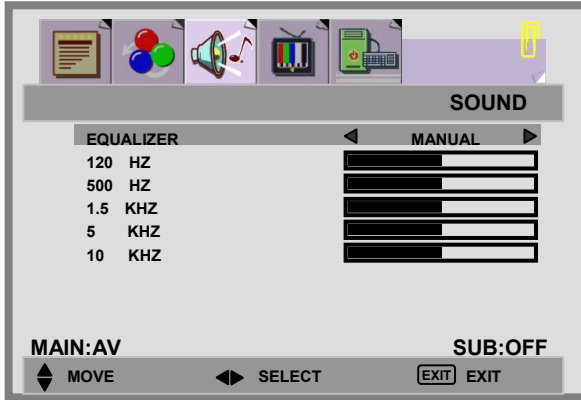

**AUDIO SWAP
Button**



Note:

When using the PIP feature in PC mode, you are able to listen to the sound of the [SUB] screen instead of the [MAIN] screen by selecting the AUDIO SWAP button.

FUNCTION

1. Press the **MENU** button to display FUNCTION from the main menu.
2. Press the **▲ / ▼** button to move to one of the sub-menu options.
3. Press the **◀ / ▶** button to select the settings.
4. Press the **EXIT/INFO** button to return to the previous screen.

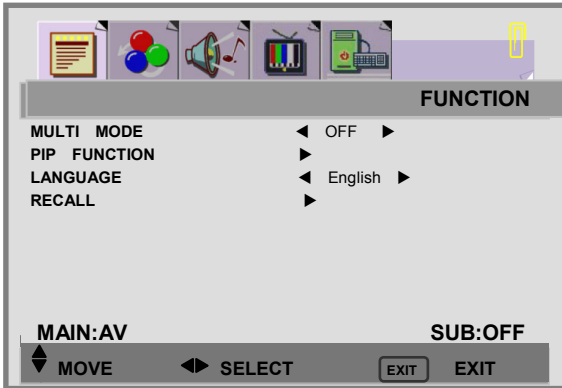

MULTI MODE:

1. Press the **▼** button to select MULTI MODE option.
2. Press the **◀ / ▶** button to select the [OFF], [PIP], [POP] mode.

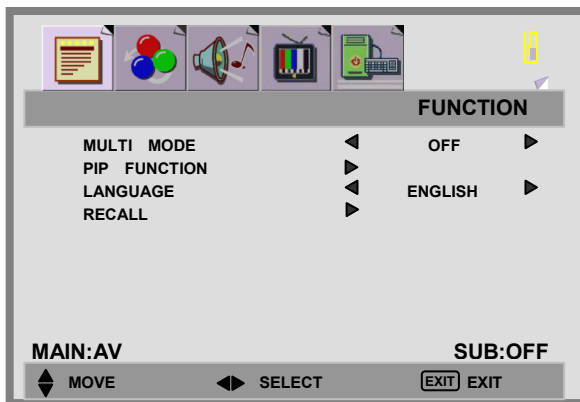

[OFF]:Only show the primary source.(No PIP/POP)

[PIP] :Show PIP in a screen.



[POP] :Show PIP side by side with the main source.



3. Press the **EXIT/INFO** button to return to the previous screen.

PIP FUNCTION:

1. Press the ▼ button to select PIP FUNCTION option.

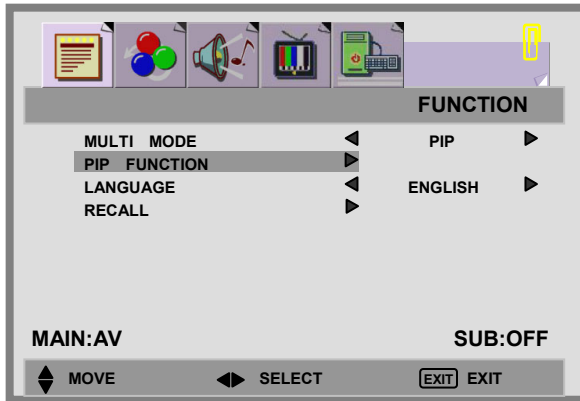

2. Press the ► button to enter PIP FUNCTION sub-menu.

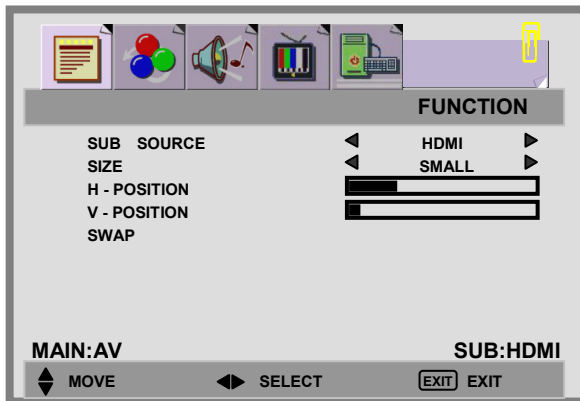

3. Press the ▲ / ▼ button to move to one of the sub-menu items.
4. Press the ◀ / ▶ button to select the settings.

SUB SOURCE: You can select a second source [HDMI],[AV],[SV], [SCART 1], [SCART 2], [SCART 2S], [YPBPR], [PC], as sub-window.

SIZE: Three different PIP sizes. [SMALL], [MIDDLE], [LARGE].

H-POSITION / V-POSITION: Pressing the ◀ / ▶ button can make PIP window move from corner to corner on the LCD screen.

SWAP: To exchange the display of main source and sub-source.

This table shows what types of sources can work in main picture and PIP picture. “Main” means main source and “Sub” means sub source. The symbol “O” means both main source and sub source can operate.

Sub Main	PC	HDMI	YPBPR	SV	AV	SCART 1	SCART 2	SCART 2S
PC	X	X	X	O	O	O	O	O
HDMI	X	X	X	O	O	O	O	O
YPBPR	X	X	X	O	O	O	O	O
SV	O	O	O	X	O	O	O	O
AV	O	O	O	O	X	O	O	O
SCART 1	O	O	O	O	O	X	O	O
SCART 2	O	O	O	O	O	O	X	O
SCART 2S	O	O	O	O	O	O	O	X

LANGUAGE:

1. Press the ▼ button to select MULTI MODE option.
2. Choose a language. [ENGLISH], [DEUTSCH], [NEDERLANDS], [ITALIANO], [CASTELLANO], [FRANCAIS], [DANSK], [NORSK], [SVENSKA], [SUOMI], 简体中文 [SIMPLIFIED CHINESE]

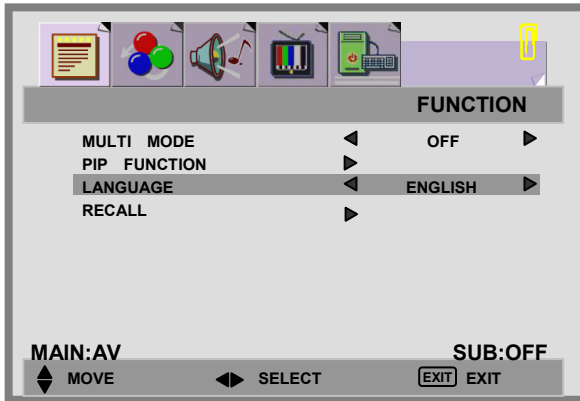

RECALL: Reset to factory settings.

PC MENU

1. Press the **MENU** button to display PC from the main menu.
2. Press the **▲ / ▼** button to move to one of the sub-menu options.
3. Press the **◀ / ▶** button to select the settings.
4. Press the **EXIT/INFO** button to return to the previous screen.

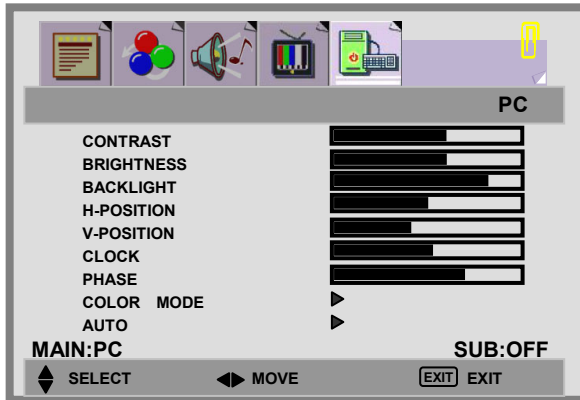

CONTRAST: Increase and decrease picture contrast

BRIGHTNESS: Darken and brighten picture brightness

BACKLIGHT: Adjust the back light level of screen

H POSITION: Adjust picture horizontal position.
Note: Not available in HDMI source.

V POSITION: Adjust picture vertical position.
Note: Not available in HDMI source.

CLOCK: Adjust picture width.
Note: Not available in HDMI source.

PHASE: Adjust picture focus quality.
Note: Not available in HDMI source.

COLOR MODE :

1. Press the ▲ / ▼ buttons to select COLOR MODE option, and then press the ► button to enter the COLOR TEMP. sub-menu.

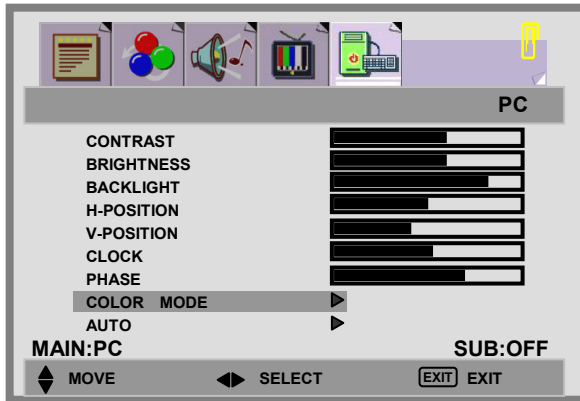

2. Press the ► button to choose the color of picture mode. [NORMAL], [WARM], [COOL], [MANUAL].

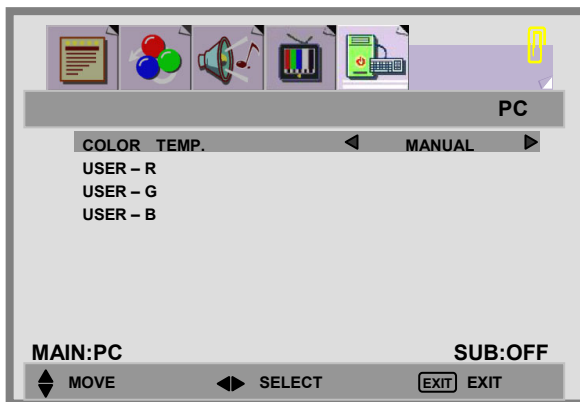

3. Press ▲ / ▼ buttons to move USER-R/G/B and then press the ► button to enter the desired setting.

USER-R: adjust the red ratio of the picture

USER-G: adjust the green ratio of the picture

USER-B: adjust the blue ratio of the picture

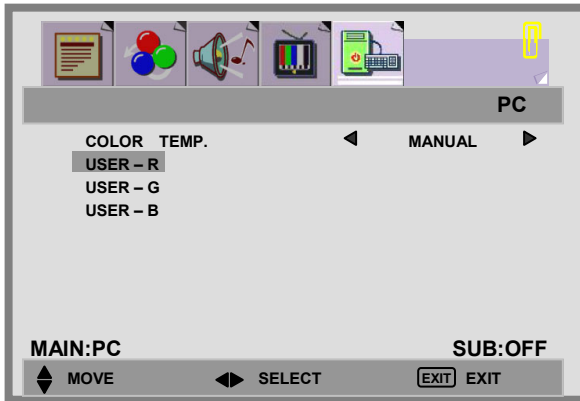

AUTO: Automatically adjust picture. Press the ► button to adjust picture position automatically. Screen will disappear until it has completed adjustment.

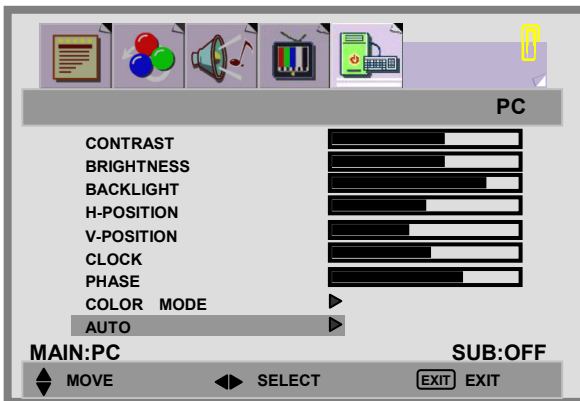

9. OTHER FUNCTIONS

1. – **ARC** - Aspect Ratio Control

Press **ARC** to adjust different picture format on the screen. Please note: in some sources, some modes are only available. In PC mode, only **FULL** and **NORMAL** modes are available.

FULL:

This mode expands the width of 4:3 video sources evenly to fill the 16:9 screen. There will be distortion at the center of the screen as well as edges.

NORMAL :

This sets the aspect ratio to 4:3 for traditional TV programs. There will be black bars at either side of the screen.



PANORAMIC :

Expands 4:3 video sources to fit the 16:9 screen by expanding the image at the edges of the screen. This creates less distortion at the centre of the screen.



ZOOM 1 (16:9) :

Some DVD movies may not fill the top and bottom of the screen. The 16:9 zoom function extends the height to fill the screen.

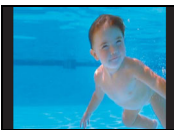

ZOOM 2 (14:9) :

In the mode, to display 14:9 broadcasts in the correct proportions. There will be black boards at both sides of the screen.

2. – **APC** - Automatic Picture Control

Press **APC** button on the remote control repeatedly to cycle through the APC settings. This is to adjust the brightness and contrast of screen.

- * **Movie:** the contrast is around 0.51 times of standard mode.
- * **Manual:** default brightness is around 0.91 times that of standard mode, and adjustment is available.
- * **Standard:** the standard settings for the best picture.
- * **Bright:** the contrast is around 1.37 times that of standard mode.

10. TROUBLESHOOTING

Many times, problems have simple causes. We would like to give you some tips to solve some common problems. Should these tips not help, please contact your dealer.

There is no picture.

- Make sure the power cord is properly connected.
- Make sure the input mode is set correctly.

There is no picture.

- Make sure the Contrast/Brightness is properly adjusted.
- Make sure all external devices are connected properly.

Picture is too bright.

- Check the APC function setting.
- Check Contrast/Brightness adjustment.

The picture is too dark.

- Check the APC function setting.
- Check Contrast/Brightness adjustment.

Remote control does not work.

- Check the batteries in the remote control are not flat.
- Make sure the sensor of LCD is not under strong lighting.

The picture is not sharp.

- Check the colour adjustment.
- Check the Sharpness adjustment.

The picture is jittery.

- Make sure the LCD isn't near Microwave Oven or other equipment.

The picture has double or triple image.

- There may be reflected signals from mountains or buildings.

The picture is spotty.

- There may be interference from automobiles, trains, high voltage lines, neon light, etc.

There are stripes on the screen or colours fade.

- Is the unit receiving interference from other devices?
Transmission of radio broadcasting station and transmission of amateur radio and cellular phones may also cause interference.
- Place the unit as far apart as possible from devices that may cause possible interference.

11.PC INPUT PRESET TIMING TABLE

Analog Input

No.	Mode Name	H-Resolution V-Resolution	H.Freq. (KHz)	V.Freq. (Hz)	H. Polarity	V. Polarity	Pixel CLK (MHz)
1	VGA	640 * 350	31.469	70.087	-	-	25.175
2	VGA	640 * 480	31.469	59.941	-	-	25.175
3	MAC	640 * 480	35.0	66.667	-	-	30.240
4	SVGA	800 * 600	35.16	56.25	+	+	36.000
5	SVGA	800 * 600	37.879	60.317	+	+	40.000
6	XGA	1024 * 768	48.363	60.004	-	-	65.000
7	XGA	1024 * 768	56.476	70.069	-	-	75.000
8	WXGA	1280 * 768	47.78	59.87	-	+	79.50
9	WXGA	1360 * 768	47.7	59.94	+	+	85.5

* The resolution and the frequencies are displayed on the screen may not exactly same as this list.

12.SPECIFICATIONS

ITEMS		SPECIFICATION
Panel	Screen Size	32" TFT-LCD Panel
	Aspect Ratio	16:9
	Resolution	1366 x 768
	Display Area (Opening)	703.6 mm x 398.3 mm
	Display colors	16,7M colors (8 bits)
	Contrast Ratio	1200 : 1 (typ.)
	Brightness (center)	500 cd / m ² (typ.)
	Viewing Angle (CR>10)	176° (Hor.) / 176° (Ver.)
	Response Time (GTG)	8 ms (typ.)
Video Input	Video Colour System	PAL / SECAM / NTSC
	AV1 (scart)	21-pin SCART (RGB / CVBS) x 1 21-pin SCART (RGB / CVBS / SVHS) x 1
	AV2 (composite)	Composite (RCA jack) x 1 S-Video x 1
	AV3 (component)	Y Pb Pr (720p / 1080 i , HD ready) x 1
	AV4 (HDMI)	HDMI 19 pin x 1 (HDMI 1.0/HDCP 1.1)
PC Input	VGA Connection	D-Sub 15 pin x 1
	Scanning Frequency	f _H = 31.5 ~ 75KHz / f _V = 56 ~ 75Hz

ITEMS		SPECIFICATION
Audio Input	Audio 1	Scart x 2
	Audio 2	Composite/S-Video x 1
	Audio 3	Component x 1
	Audio 4	PC x 1
Video Output	SCART 2	CVBS (SCART 1) x 1
Audio Output	Speaker (build-in)	10W+10W (rms) @ THD < 10% (optional)
	Line Out	Left / Right / Subwoofer
	S/P DIF	HDMI loop through
Feature	OSD Language	English, French, German, Spanish, Italian, Finnish, Swedish, Dutch, Danish, Norwegian, Simplified Chinese
	Function Keys	Power, Source, Menu, Up/Down, +/- (Volume), EXIT/ARC
	Video Performance	3D Comb-filter, 3D De-interlace , Aspect Ratio Control (ARC) ,Auto Picture Control (APC), Video Enhance,Noise Reduction, Picture in Picture (PIP), Picture on Picture (POP)
	Audio Performance	Equalizer, Subwoofer, Auto Volume Control (AVC)
	Other Control	Sleep Timer, Auto Power Off
Power	Power Supply	AC 100V ~ 240V , 50 / 60Hz
	Power Consumption	< 190 W
Dimension	W x H x D	828 mm*515 mm* 99 mm
Weight (net)	Without Accessories	15 kg

Customer Support

For technical support or product service, see the table below or contact your reseller.

NOTE: You will need the product serial number.

Country/Region	Website	T = Telephone F = FAX	Email
Australia/New Zealand	www.viewsonic.com.au	AUS= 1800 880 818 NZ= 0800 008 822	service@au.viewsonic.com
Canada	www.viewsonic.com	T= 1-866-463-4775 F= 1-909-468-5814	service.ca@viewsonic.com
Europe/Middle East/ Baltic countries/North Africa	www.viewsoniceurope.com	Contact your reseller	
Hong Kong	www.hk.viewsonic.com	T= 852 3102 2900	service@hk.viewsonic.com
India	www.in.viewsonic.com	T= 1800 11 9999	service@in.viewsonic.com
Korea	www.kr.viewsonic.com	T= 080 333 2131	service@kr.viewsonic.com
Latin America (Argentina)	www.viewsonic.com/la/	T= 0800-666-0098 F= 1-909-444-5655	soporte@viewsonic.com
Latin America (Brazil)	www.viewsonic.com/la/	T= 0800-891-1829 F= 1-909-444-5655	soporte@viewsonic.com
Latin America (Chile)	www.viewsonic.com/la/	T= 800-440303 F= 1-909-444-5655	soporte@viewsonic.com
Latin America (Columbia)	www.viewsonic.com/la/	T= 01800-9-156588 F= 1-909-444-5655	soporte@viewsonic.com
Latin America (Mexico)	www.viewsonic.com/la/	T= 001-866-823-2004 F= 1-909-444-5655	soporte@viewsonic.com
Latin America (Peru)	www.viewsonic.com/la/	T= 0800-53311 F= 1-909-444-5655	soporte@viewsonic.com
Macau	www.hk.viewsonic.com	T= 853 700 303	service@hk.viewsonic.com
Puerto Rico & Virgin Islands	www.viewsonic.com	T= 1-800-688-6688 (English) T= 1-866-379-1304 (Spanish) F= 1-909-468-1202	service.us@viewsonic.com soporte@viewsonic.com
Singapore/Malaysia/ Thailand	www.ap.viewsonic.com	T= 65 6461 6044	service@sg.viewsonic.com
South Africa	www.viewsoniceurope.com	www.viewsoniceurope.com/uk/Support/Calldesk.htm	
United Kingdom	www.viewsoniceurope.com /uk/	www.viewsoniceurope.com/uk/Support/Calldesk.htm	
United States	www.viewsonic.com	T= 1-800-688-6688 F= 1-909-468-1202	service.us@viewsonic.com

Limited Warranty

VIEWSONIC® LCD DISPLAY

What the warranty covers:

ViewSonic warrants its products to be free from defects in material and workmanship, under normal use, during the warranty period. If a product proves to be defective in material or workmanship during the warranty period, ViewSonic will, at its sole option, repair or replace the product with a like product. Replacement product or parts may include remanufactured or refurbished parts or components.

How long the warranty is effective:

ViewSonic LCD displays are warranted for 1 year for all parts including the light source and 1 year for all labor from the date of the first consumer purchase.

Who the warranty protects:

This warranty is valid only for the first consumer purchaser.

What the warranty does not cover:

1. Any product on which the serial number has been defaced, modified or removed.
2. Damage, deterioration or malfunction resulting from:
 - a. Accident, misuse, neglect, fire, water, lightning, or other acts of nature, unauthorized product modification, or failure to follow instructions supplied with the product.
 - b. Repair or attempted repair by anyone not authorized by ViewSonic.
 - c. Any damage of the product due to shipment.
 - d. Removal or installation of the product.
 - e. Causes external to the product, such as electrical power fluctuations or failure.
 - f. Use of supplies or parts not meeting ViewSonic's specifications.
 - g. Normal wear and tear.
 - h. Any other cause which does not relate to a product defect.
3. Any product exhibiting a condition commonly known as "image burn-in" which results when a static image is displayed on the product for an extended period of time.
4. Removal, installation, and set-up service charges.

How to get service:

1. For information about receiving service under warranty, contact ViewSonic Customer Support (Please refer to Customer Support page). You will need to provide your product's serial number.
2. To obtain warranted service, you will be required to provide (a) the original dated sales slip, (b) your name, (c) your address, (d) a description of the problem, and (e) the serial number of the product.
3. Take or ship the product freight prepaid in the original container to an authorized ViewSonic service center or ViewSonic.
4. For additional information or the name of the nearest ViewSonic service center, contact ViewSonic.

Limitation of implied warranties:

There are no warranties, express or implied, which extend beyond the description contained herein including the implied warranty of merchantability and fitness for a particular purpose.

Exclusion of damages:

ViewSonic's liability is limited to the cost of repair or replacement of the product. ViewSonic shall not be liable for:

1. Damage to other property caused by any defects in the product, damages based upon inconvenience, loss of use of the product, loss of time, loss of profits, loss of business opportunity, loss of goodwill, interference with business relationships, or other commercial loss, even if advised of the possibility of such damages.
2. Any other damages, whether incidental, consequential or otherwise.
3. Any claim against the customer by any other party.

Effect of state law:

This warranty gives you specific legal rights, and you may also have other rights which vary from state to state. Some states do not allow limitations on implied warranties and/or do not allow the exclusion of incidental or consequential damages, so the above limitations and exclusions may not apply to you.

Sales outside the U.S.A. and Canada:

For warranty information and service on ViewSonic products sold outside of the U.S.A. and Canada, contact ViewSonic or your local ViewSonic dealer.

The warranty period for this product in mainland China (Hong Kong, Macao and Taiwan Excluded) is subject to the terms and conditions of the Maintenance Guarantee Card.

CD3200 RS-232 Protocol

Table of content

1	Introduction	ii
2	Description.....	ii
2.1	Hardware specification	ii
2.2	Communication Setting	ii
2.3	Command Message Reference	ii
3	Set-Function Listing	ii
4	Get-Function Listing.....	vi
5	Remote Control Pass-through mode	ix
Table 2-1: PC Set-function command to LCD Monitor (ID=C0h)		iv
Table 2-2: PC Get-function command to LCD Monitor.....		vii
Table 2-3: Baseline RCU Pass-through codes.....		x

1 Introduction

This document describes the hardware interface spec and software protocols of RS232 interface communication between Viewsonic Commercial Display and PC or other control unit with RS232 protocol.

The protocol divide into three sections:

- Set-Function
- Get-Function
- Remote control pass-through mode

※In below document, “PC” will represents all the control units that can sent or receive the RS232 protocol command.

2 Description

2.1 Hardware specification

Viewsonic LCD communication port in the rear side

- (1) Connector type: DSUB 9 Pin Male
- (2) Pin Assignment

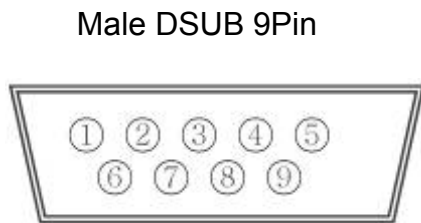

(outside view)

Pin #	Signal	Remark
1	NC	
2	RXD	Input to LCD Monitor
3	TXD	Output from LCD Monitor
4	NC	
5	GND	
6	NC	
7	NC	
8	NC	
9	NC	
frame	GND	

*Use of crossover (null modem) cable required for use with PC

2.2 Communication Setting

- Baud Rate Select: 9600bps (fixed)
- Data bits: 8bits (fixed)
- Parity: None (fixed)
- Stop Bits: 1(fixed)

2.3 Command Message Reference

PC sends to Monitor command packet followed by “CR”. Every time PC sends control command to the Monitor, the Monitor shall response as follows:

1. If the message is receives correctly it will send “+” (02Bh) followed by “CR” (00Dh)
2. If the message is receives incorrectly it will send “-” (02Dh) followed by “CR” (00Dh)

3 Set-Function Listing

The PC can control the LCD Monitor for specific actions. The Set-Function command allows you to control the LCD monitor behavior in a remote sit through the RS232 port. The Set-Function packet format consists of 5 bytes. Note that the “Value” byte is always = 00.

Set-Function description:

Length: Total bytes of message = 5 ASCII (35H) excluding "CR"

Command: Function command code: One byte ASCII code

Value[1~3]: Three bytes ASCII that defines the value

Set-Function format:

Name	Length	Command	Value1	Value2	Value3	CR
Byte Count	1 Byte	1 Byte	1 Byte	1 Byte	1 Byte	1 Byte
Bytes order	1	2	3	4	5	6

All Set-Function from PC to Monitor (ASCII)

Name	Length	Command	Value1	Value2	Value3	CR
Byte Count	5	1 Byte	1 Byte	1 Byte	1 Byte	00D
Bytes order	1	2	3	4	5	6

Example: Set Mute-ON command (ASCII)

Name	Length	Command	Value1	Value2	Value3	CR
Byte Count	5	6	0	0	0	00D
Bytes order	1	2	3	4	5	6

Example: Set Mute-OFF command (ASCII)

Name	Length	Command	Value1	Value2	Value3	CR
Byte Count	5	6	0	0	1	00D
Bytes order	1	2	3	4	5	6

Example: Set Tint to -50 command (ASCII)

Name	Length	Command	Value1	Value2	Value3	CR
Byte Count	5	'	-	5	0	00D
Bytes order	1	2	3	4	5	6

LCD Monitor will send “+” (02Bh) and “CR” bytes to PC after receiving a valid command.
 LCD Monitor will send “-” (02Dh) and “CR” bytes to PC if the command is not valid.

Value Range: Three bytes ASCII value range
 Command Code: Function command code in ASCII

Table 3-1: PC Set-function command to LCD Monitor (ID=C0h)

Set Function	Command Code (ASCII)	Command Code (Hex)	Value Range (Three ASCII bytes)	Comments
HDTV Power	!	21	000: STBY 001: ON	Controlled the HDTV power status: ON or Standby
Input Select	“	22	000: VGA 001: DVI 002: COMPOSITE1 003: COMPOSITE2 004: COMPONENT1 005: COMPONENT2 006: S-Video1 007: S-Video2 008: HDMI1 009: HDMI2 010: HDMI3 011: HDMI4 012: HDMI5 ~	
Contrast	#	23	000 ~ 100	
Brightness	\$	24	000 ~ 100	
Sharpness	%	25	000 ~ 100	
Color	&	26	000 ~ 100	
Tint	‘	27	-50 ~ +50	
Flesh tone	(28	000: OFF 001: ON	Set and reset Flesh tone
White Balance)	29	000: STD 001: WARM 002: COLD	Sets White balance
Reserved	*	2A		For future use
Reserved	+	2B		For future use
Reserved	,	2C		For future use
Sound Effect	-	2D	000: SRS OFF 001: SRS ON	Set and reset SRS
Bass	.	2E	000 ~ 100	Sets Bass value
Treble	/	2F	000 ~ 100	Sets Treble value
Balance	0	30	000 ~ 100	Sets Balance position
Picture Size	1	31	000: SMART 001: 4 x 3 002: 16 x 9 003: ZOOM	
OSD Language	2	32	000: English 001: Deutsch 002: Francias 003: Italiano 004: Espanol 005: Dutch 006: Dansk 007: Traditional Chinese 008: Japanese 009: Brazilian 010: Reserved 011: Reserved 012: Reserved : : : 999: Reserved	
OSD timeout	3	33	000: 10sec 001: 20sec 002: 30sec	Set OSD timeout
Reserved	4	34		For future use
Volume	5	35	000 ~ 100	
Mute	6	36	000: OFF 001: ON (mute)	

Sleep	7	37	000: OFF 001: 10 Min 002: 20 Min 003: 30 Min 004: 60 Min 005: 90 Min 006: 120 Min 007: 150 Min ~	
Reserved	8	38		For future use
PIP Mode	9	39	000: OFF 001: ON	
PIP Sound select	:	3A	000: MAIN 001: PIP	
PIP position	;	3B	000: UP_LEFT 001: UP_RIGHT 002: DOWN_LEFT 003: DOWN_RIGHT	
PIP Input	<	3C	000: None 001: None 002: COMPOSIT1 003: COMPOSIT2 004: COMPONENT1 005: COMPONENT2 006: S-Video1 007: S-Video2 008: HDMI1 009: HDMI2 010: HDMI3 011: HDMI4 012: HDMI5 ~	
TV Channel	=	3D	000 ~ 999	
Reserved	>	3E		For future use
Reserved	?	3F		For future use
Number	@	40	000 ~ 009	
Key Pad	A	41	000: UP 001: DOWN 002: LEFT 003: RIGHT 004: ENTER 005: INPUT 006: MENU/EXIT ~	
Remote Control	B	42	000: DISABLE 001: ENABLE 002: PASS THROUGH	Disable: RCU has no effect on HDTV. Enabled: RCU controls the HDTV. This is the power up default on the HDTV. Pass through: RCU has no effect on HDTV and all RCU command codes are transmitted to FC via the RS232 port. See page ix for more details
Key Pad	C	43	000: DISABLE 001: ENABLE	Disable: Key Pad have no effect on HDTV. Enabled: Key Pad control the HDTV. This is the power up default on the HDTV.
Factory reset	~	7E	000	Rests HDTV to factory setting

4 Get-Function Listing

The PC can interrogate the LCD Monitor for specific information. The Get-Function packet format consists of 5 bytes which is similar to the Set-Function packet structure. Note that the "Value" byte is always = 00.

Get-Function description:

Length: Total bytes of message = 5 ASCII (35H), excluding "CR"

Command: Get-Function command code: One byte ASCII code

Value[1~3]: Always = 000

Get-Function format from PC to LCD (ASCII)

Name	Length	Command	Value1	Value2	Value3	CR
Byte Count	5	1 Byte	0	0	0	00D
Bytes order	1	2	3	4	5	6

Monitor shall response to Get-Function with the following packet format:

LCD Monitor response packet format:

Name	Length	Value1	Value2	Value3	Value4	CR
Byte Count	5	1 Byte	1 Byte	1 Byte	1 Byte	00D
Bytes order	1	2	3	4	5	6

Response packet (to Get-Function):

Length: Total bytes of packet = 5 ASCII excluding "CR"

Exception: Total bytes for On-Hours = 6

Value[1-4]: Four ASCII codes: Value range is from 0000 ~ 9999

Exception: Value[1-5] for On-Hours

LCD Monitor will send "+" (02Bh), "CR" bytes to PC after receiving a valid command

LCD Monitor will send "-" (02Dh), "CR" bytes to PC if the command is not valid

Table 4-1 outlines the Get-function command list that must be supported by the LCD Monitor

Table 4-1: PC Get-function command to LCD Monitor

Get Function	Command Code (ASCII)	Command Code (Hex)	Response Range (Three ASCII bytes)	Comments
Get-Contrast	a	61	000 ~ 100	Gets Contrast value
Get-Brightness	b	62	000 ~ 100	Gets Brightness value
Get-Sharpness	c	63	000 ~ 100	Gets Sharpness value
Get-Color	d	64	000 ~ 100	Gets Color value
Get-Tint	e	65	-50 ~ +50	Gets Tint value
Get-Volume	f	66	000 ~ 100	Gets Volume value
Get-Mute	g	67	000: OFF (unmuted) 001: ON (muted)	Gets Mute ON/OFF status
Get-RCU	h	68	000: DISABLE 001: ENABLE 002: PASS THROUGH	Gets RCU mode status
Get-Key Pad	i	69	000: DISABLE 001: ENABLE	Gets Buttons ON/OFF status
Get-Input select	j	6A	000: VGA 001: DVI 002: COMPOSITE1 003: COMPOSITE2 004: COMPONENT1 005: COMPONENT2 006: S-Video1 007: S-Video2 008: HDMI1 009: HDMI2 010: HDMI3 011: HDMI4 012: HDMI5	Gets Input select status
Reserved	k	6B		Reserved for future expansion
Get-Power status	l	6C	000: STBY 001: ON	Gets the status of the HDTV power. HDTV response: 000 = HDTV is in standby 001 = HDTV is ON
Get-On hours	m	6D	00000 ~ 99999	Get the ON hours of the HDTV. HDTV shall accumulate the ON hours in Flash memory. When it receives this command it will response with the ON hour value of 5 bytes.
Get-ACK	z	7A	000	This command is used to test the communication link.

- The following is an example of PC requesting the volume value from the LCD Monitor:

PC send Get-Volume-value packet to Monitor (In ASCII)

Name	Length	Command	Value1	Value2	Value3	CR
Byte Count	5	f	0	0	0	00D
Bytes order	1	2	3	4	5	6

LCD Monitor will send “-” (02Dh), “CR” to PC if command is not recognized.
Otherwise the LCD Monitor will respond with the volume value as outlined below:

LCD-Monitor response packet to Get-volume-value (in this example the volume value is 50):

Name	Length	Value1	Value2	Value3	Value4	CR
Byte Count	5	0	0	5	0	00D
Bytes order	1	2	3	4	5	6

- The following is an example of PC requesting the On-hours value from the LCD Monitor

PC send “Get-On hours” command to Monitor (In ASCII)

Name	Length	Command	Value1	Value2	Value3	CR
Byte Count	5	m	0	0	0	00D
Bytes order	1	2	3	4	5	6

LCD Monitor will send “-” (02Dh), “CR” bytes to PC if the command is not valid
Otherwise the LCD Monitor will respond with the On-Hours value as outlined below:

LCD-Monitor response packet to Get-On-hours value is 12,500 hours):

Name	Length	Value1	Value2	Value3	Value4	Value5	CR
Byte Count	6	1	2	5	0	0	00D
Bytes order	1	2	3	4	5	6	7

Note that this response contain 6-bytes

A special command “Get-ACK” is used to test the communication link between PC and the LCD Monitor. The LCD Monitor shall response to “Get-ACK” command with a “+” or “-”.

Get-ACK from PC to LCD (ASCII)

Name	Length	Command	Value1	Value2	Value3	CR
Byte Count	5	z	0	0	0	00D
Bytes order	1	2	3	4	5	6

LCD Monitor will send “+” (02Bh); “CR” bytes to NMP-530 after receiving the command indicating that the communication link is OK

5 Remote Control Pass-through mode

When PC sets the LCD monitor to Remote Control Pass through mode, the LCD shall send a three bytes packet (followed by "CR") in response to RCU button activation. **Note, that in this mode the RCU shall have no effect on the monitor function.** For example: "+Volume" will not change the volume in the LCD but only sends "+Volume" code to PC over the RS232 port.

Remote Control pass-through packet format from LCD monitor to PC(ASCII)

Name	Length	RCU-Code1	RCU-Code2	CR
Byte Count	3	MSB	LSB	00D
Bytes order	1	2	3	4

Example: Remote Control pass-through when "Menu" key is pressed (1A)

Name	Length	RCU-Code1	RCU-Code2	CR
Byte Count	3	1	A	00D
Bytes order	1	2	3	4

Example: Remote Control pass-through when key "1" is pressed (01)

Name	Length	RCU-Code1	RCU-Code2	CR
Byte Count	3	0	1	00D
Bytes order	1	2	3	4

Example: Remote Control pass-through when "OK" key is pressed (1F)

Name	Length	RCU-Code1	RCU-Code2	CR
Byte Count	3	1	F	00D
Bytes order	1	2	3	4

Table 5-1: Baseline RCU Pass-through codes

Key	Code (HEX)	Key	Code (HEX)
1 /SPACE	01		31
2 /ABC	02		32
3 /DEF	03		33
4 /GHI	04		34
5 /JKL	05		35
6 /MNO	06		36
7 /PQRS	07		37
8 /TUV	08		38
9 /WXYZ	09		39
0 /@:/	0A		3A
100	0B		3B
RECALL	0C		3C
SHIFT	0D		3D
CLEAR	0E		3E
ZOOM	0F		3F
VOLUME UP (+) ▲	10		40
VOLUME DOWN (-) ▼	11		41
MUTE	12		42
CHANNEL/PAGE UP (+) ▲	13		43
CHANNEL/PAGE DOWN (▼)	14		44
ON/STANDBY	15		45
SOURCES (INPUTS)	16		46
PIP/POP	17		47
WIDE	18		48
SLEEP	19		49
MENU	1A		4A
UP ▲	1B		4B
DOWN ▼	1C		4C
LEFT ◀	1D		4D
RIGHT ▶	1E		4E
OK (ENTER)	1F		4F
PLAY ▶	20		50
PAUSE	21		51
FAST FORWARD ▶▶	22		52
FAST BACKWARD ◀◀	23		53
SKIP ▶	24		54
REPLAY ◀	25		55
STOP ■	26		56
RECORD ●	27		57
	28		58
	29		59
	2A		5A
	2B		5B
	2C		5C
	2D		5D
	2E		5E
	2F		5F

CD3200 RS-232 Command Table

SET FUNCTION CODES

No	Set Function	Command	Value Range	Comments
1	Monitor Power	!	000: ON 001: STBY	Controlled the Monitor power status: ON or Standby
2	Input Select	"	000: VGA 001: DVI (None) 002: COMPOSITE1 003: COMPOSITE2 (None) 004: COMPONENT1 005: COMPONENT2 (None) 006: S-Video1 007: S-Video2 (None) 008: HDMI1 009: HDMI2 (None) 010: SCART 1 011: SCART 2 012: SCART 2S	
3	Contrast	#	000 ~ 100	
4	Brightness	\$	000 ~ 100	
5	Sharpness	%	000 ~ 100	
6	Saturation	&	000 ~ 100	
7	Hue	'	000 ~ 100	
8	Flesh tone (None)	(000: ON 001: OFF	Set and reset Flesh tone
9	White Balance (None))	000: STD 001: Warm 002: Cold	Sets White balance
10	Reserved	*		For future use
11	Reserved	+		For future use
12	Reserved	,		For future use
13	Sound Effect (None)	-	000: SRS ON 001: SRS OFF	Set and reset SRS
14	Bass	.	000 ~ 100	Sets Bass value
15	Treble	/	000 ~ 100	Sets Treble value
16	Balance	0	000 ~ 100	Sets Balance position
17	Picture Size	1	000: Panorama 001: Normal 002: Full 003: ZOOM 004: ZOOM2	
18	OSD Language	2	000: English 001: Deutsch 002: Francias 003: Italiano 004: Espanol 005: Dutch 006: Dansk 007: Simplified Chinese 008: Japanese (none) 009: Brazilian (none) 010: NORSK 011: SVENSKA 012: SUOMI	
19	OSD timeout	3	000: 10sec 001: 20sec 002: 30sec	Set OSD timeout
20	Reserved	4		For future use
21	Volume	5	000 ~ 100	
22	Mute	6	000: ON 001: OFF	
23	Sleep	7	000: OFF 001: 10 Min 002: 20 Min 003: 30 Min 004: 60 Min 005: 90 Min 006: 120 Min 007: 150 Min (None) 008 : Reserved	
24	Reserved	8		For future use
25	PIP Mode	9	000: PIP 001: OFF	













			002: POP	
26	PIP Sound select	:	000: Main 001: PIP	
27	PIP position	;	000: Up_left 001: Up_right 002: Down_left 003: Down_right	
28	PIP Input	<	000: VGA 001: DVI (None) 002: COMPOSITE1 003: COMPOSITE2 (None) 004: COMPONENT1 005: COMPONENT2 (None) 006: S-Video1 007: S-Video2 (None) 008: HDMI1 009: HDMI2 (None) 010: SCART 1 011: SCART 2 012: SCART 2S	
29	TV Channel	=	000 ~ 099	
30	Reserved	>		For future use
31	Reserved	?		For future use
32	Number	@	000 ~ 009	
33	Key Pad	A	000: UP 001: DOWN 002: LEFT 003: RIGHT 004: MENU 005: SOURCE 006: POWER 007: ASPECT/EXIT	
34	Remote Control	B	000: Disable 001: Enable 002: Pass through	Disable: RCU has no effect on LCD monitor. Enabled: RCU controls the LCD monitor. This is the power up default on the LCD monitor. Pass through: RCU has no effect on LCD monitor and all RCU command codes are transmitted to HOST via the RS232 port. See Table 3-3
35	Key Pad	C	000: Disable 001: Enable	Disable: Key Pad have no effect on LCD Monitor. Enabled: Key Pad control the LCD Monitor. This is the power up default on the LCD monitor.
36	Factory reset	~	000	Rests monitor to factory setting
37	Picture Mode	D	000: USER 001: STANDARD 002: MOVIE 003: BRIGHT	
38	Color Temp	E	000: NORMAL 001: WARM 002: COOL 003: MANAUL	
39	AVC	F	000: ON 001: OFF	
40	Mode	G	000: OFF 001: EQ	
41	Equalizer	H	000: Manual 001: Voice 002: POP 003: Rock 004: Jazz 005: Classic	
42	PC / Auto	I	000: Execute	

GET FUNCTION CODES

No	Get Function	Command	Response Range	Comments
1	Get-Contrast	a	000 ~ 100	Gets Contrast value
2	Get-Brightness	b	000 ~ 100	Gets Brightness value
3	Get-Sharpness	c	000 ~ 100	Gets Sharpness value
4	Saturation	d	000 ~ 100	Gets Color value
5	Hue	e	000 ~ 100	Gets Tint value
6	Get-Volume	f	000 ~ 100	Gets Volume value
7	Get-Mute	g	000: ON 001: OFF	Gets Mute ON/OFF status
8	Get-RCU	h	000: Disable 001: Enable 002: Pass through	Gets RCU mode status
9	Get-Key Pad	i	000: Disable 001: Enable	Gets Buttons ON/OFF status
10	Get-Input select	j	000: VGA 001: DVI (None) 002: COMPOSITE1 003: COMPOSITE2 (None) 004: COMPONENT1 005: COMPONENT2 (None) 006: S-Video1 007: S-Video2 (None) 008: HDMI1 009: HDMI2 (None) 010: SCART 1 011: SCART 2 012: SCART 2S	
11	Reserved	k		Reserved for future expansion
12	Get-Power	l	000 = ON 001 = STBY	Gets the status of the Monitor power. Monitor response: 00 = Monitor is ON 01 = Monitor is in standby
13	Get-On hours (None)	m	0000 ~ 9999	Get the ON hours of the Monitor. Monitor shall accumulate the ON hours in Flash memory. When it receives this command it will response with the ON hour value of two bytes. See example on page-9
14	Get-ACK	z	000	This command is used to test the communication link.
15	Get-Bass	n	000 ~ 100	
16	Get-Treble	o	000 ~ 100	
17	Get-Balance	p	000 ~ 100	
18	Get-Picture Size	q	000: Panorama 001: Normal 002: Full 003: ZOOM 004: ZOOM2	
19	Get-OSD Language	r	000: English 001: Deutsch 002: Francias 003: Italiano 004: Espanol 005: Dutch 006: Dansk 007: Simplified Chinese 008: Japanese (none) 009: Brazilian (none) 010: NORSK 011: SVENSKA 012: SUOMI	
20	Get-OSD timeout	s	000: 10sec 001: 20sec 002: 30sec	
21	Get-Sleep	t	000: OFF 001: 10 Min 002: 20 Min 003: 30 Min 004: 60 Min 005: 90 Min 006: 120 Min 007: 150 Min (None) 008 : Reserved	
22	Get-PIP Mode	u	000: PIP 001: OFF 002: POP	
23	Get-PIP Sound select	v	000: Main 001: PIP	

24	Get-PIP position	w	000: Up_left 001: Up_right 002: Down_left 003: Down_right	
25	Get-PIP Input	x	000: VGA 001: DVI (None) 002: COMPOSITE1 003: COMPOSITE2 (None) 004: COMPONENT1 005: COMPONENT2 (None) 006: S-Video1 007: S-Video2 (None) 008: HDMI1 009: HDMI2 (None) 010: SCART 1 011: SCART 2 012: SCART 2S	
26	Get-Key Pad (None)	y	000: UP 001: DOWN 002: LEFT 003: RIGHT 004: MENU 005: SOURCE 006: POWER 007: ASPECT/EXIT	
27	Get-Picture Mode	[000: USER 001: STANDARD 002: MOVIE 003: BRIGHT	
28	Get-Color Temp]	000: NORMAL 001: WARM 002: COOL 003: MANUAL	
29	Get-AVC	{	000: ON 001: OFF	
30	Get-Mode	}	000: OFF 001: EQ	
31	Get-Equalizer	\	000: Manual 001: Voice 002: POP 003: Rock 004: Jazz 005: Classic	

PASS THROUGH CODES

Key	Code(HEX)	Key	Code(HEX)	Key	Code(HEX)
1	01		19	SOURCE/UP	32
2	02		1A	SOURCE/DOWN	33
3	03		1B	SIZE	34
4	04		1C	POSITION	35
5	05	ARC	1D		36
6	06	APC	1E		37
7	07	MUTE	1F		38
8	08	EXIT	20		39
9	09	UP	21		3A
0	0A	DOWN	22		3B
100	0B	LEFT	23		3C
RTN	0C	RIGHT	24		3D
VOLUME UP	0D	MENU	25		3E
VOLUME DOWN	0E	TV	26		3F
CH UP	0F	PC/HD	27		40
CH DOWN	10	VIDEO	28		41
	11	SCART	29		42
	12	SOUND	2A		43
	13	FREEZE	2B		44
	14	PROGRAM	2C		45
	15	SLEEP	2D		46
	16	AUDIO	2E		47
	17	VIDEO	2F		48
	18	ON/OFF	31		49

