

Operation's Manual



LCD COLOR TV

LCD-2300VT

LCD-2700VT

LCD-3018VT

LCD-3200VT

LCD-4000VT

LCD-4200VT

TOTEVISION SERVICE CENTER 1319 Dexter
Avenue N.#020, Seattle, Wa98109
TELL: (206) 623-6000 FAX: (206) 623-6609





CONTENTS

OPERATION SAFETY.....	1
TO CUSTOMERS.....	2
SAFETY & PRECAUTIONS.....	2~5
ACCESSORIES.....	6
FUNCTIONS.....	7
DIMENSIONS.....	8~15
PRODUCT SPECIFICATIONS.....	16
FEATURES.....	17
MULTI-MEDIA BOX.....	17
PRODUCT INSTALLATION.....	17
1. Antenna Installation.....	17
2. VGA Source Connection.....	18
3. DVI Source Connection.....	18
4. High Definition TV (HDTV).....	18
5. Speaker Jack(Audio Out).....	18
6. Power Connection.....	18
SOURCE INPUT CONNECTORS.....	19
POWER ON/OFF.....	20
TV/AUDIO/PC SELECTION.....	20
REMOTE CONTROL.....	21
REMOTE CONTROL PRECAUTION & USAGE.....	22
PC (RGB) MODE.....	23
BASIC OPERATION.....	24
1. Channel Selection.....	24
2. Direct Channel Selection.....	24
3. Antenna /Cable TV Setup.....	24
4. Auto Scan.....	24
AUDIO SETTINGS.....	25
PICTURE PARAMETERS.....	26~28
PC PARAMETERS.....	29~31
AUDIO SETTINGS.....	32
PICTURE-IN-PICTURE.....	23~35
CHANNEL SETTINGS.....	36
PARENTAL CONTROLS.....	37
GENERAL SETTINGS.....	38~41

OPERATION SAFETY

- **Caution :** To avoid fire and electric shocks, do not expose this product under damp or humid condition and make sure the plug is fully plugged in at all time.
- **Warning:** Never open the housing of the LCD display. When the housing is opened, there is a danger of injury from electric shock. There is no component that can be replaced by users. Please contact the service personnels and replace with manufacturer appointed components.
- **Disposal:** Due to the environmental concerns, please refer to your local authorized organization or electronics industry society before you dispose this product. Please visit [http:// www.eia.org](http://www.eia.org) for more Informations.



TO CUSTOMERS

Thank you for purchasing this product. Please read through the instructions and follow the steps in order to achieve the maximum reliability. Please keep this manual handy and close to your LCD display after reading.



SAFETY & PRECAUTIONS

Manual Guide--Please read through user's manual before operating this product.

Instructions--Please follow and be aware of cautions and warnings.

Follow Steps--Please follow the operation procedures.

Socket Outlet--Please use standard socket outlet to avoid damages to the LCD display.

Power Source--This product has to operate with correct power source shown on label.

Power Cord Protection--Avoid tangling or placing objects on the power cord.

Over-loading--Avoid AC power over-loading, which may lead to fire or electric shock.

Do not insert any objects through the slots and openings of the LCD display. This may lead to an electrical short-circuit or even cause fire and results in damages to your LCD display

Repair--Please unplug the power cord and contact distributors or qualified repair personnels if any of the following situations have happened.

1. Power cord is damaged
2. Objects have been inserted through the slots and openings of the display.
3. Product is under humid condition or liquid leakages on to the display.
4. Product cannot function normally, or cannot operate.
5. Product was dropped or damaged

Note : When using AV signals (e.g DVD, VCR..), Please check the input source if the screen appears glittering or having bad signals.

For example, cables are correctly connected and DVD player output setting is the same as TV resolution setting. (Resolution is under 480i or 576i etc.)

Parts Replacement--If any parts need to be replaced, please contact the service personnel.

Wall Mounting--Please use correct wall mount and follow instructions when installing the display onto the wall.

Cleaning--Unplug power cord beforehand. Please use dry and soft sponge to clean the screen surface. Do not use diluted acid.

Humidity--Keep this product away from moisture or high humidity area.

Placement--Place this product on a stable and vibration free surface in order to avoid the LCD display from falling.

Ventilation--Please never cover or block openings and slots of the display. This may cause the display to over-heat and reduced its life time. Please allow some space for ventilation.

Away from heat sources--Keep this product away from heat sources such as direct exposure to sunlight, heater and stove, etc. This would avoid structure distortion or machine break down.

When switched off, the LCD display can be stored comfortably between -4 to 140 (-20 to 60)

Unplug from the socket outlet if the LCD Display is not intended to be used for a long period of time.

ACCESSORIES

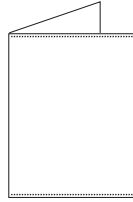

User Menu(*1)



Remote Control(*1)

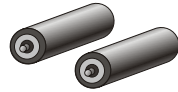

AAA Batteries(*2)



VGA Cable(*1)



Power Cable(*1)



FUNCTIONS

1. Auto-Adjustment: It helps users to adjust the display into appropriate setup.
2. Contrast/Brightness: Users are able to adjust their custom setup.
3. Color Adjustment: Users are able to adjust their custom color setup.
4. Display Frequencies: Users can use this function to check current horizontal frequency, vertical frequency, phase and resolution.
5. Position Adjustment: Users can adjust display's vertical and horizontal positions.
6. Source: Allows selection from PC, DVI, S-Video1, S-Video2, AV1, AV2, YCbCr, TV/CATV, HDTV
7. Menu Setting: Allows setup of OSD language, picture position, time and picture freeze time etc.
8. PIP setup:
 - (1) PIP source: Select PIP input source
 - (2) PIP Ver/Horz position: Allows adjustment of PIP positions.

Dimensions

23"LCD-2300VT

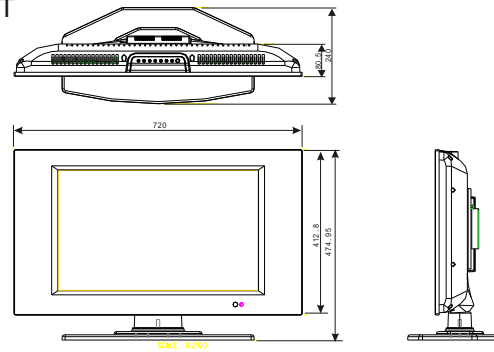

27"LCD-2700VT

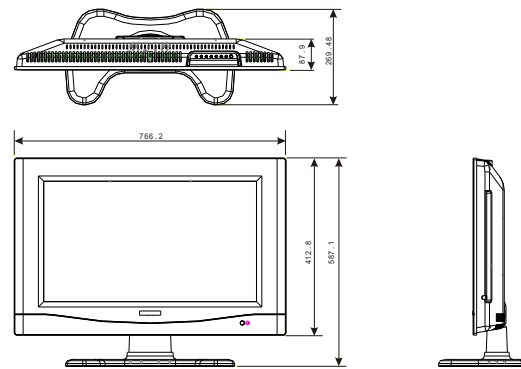

30"LCD-3018VT

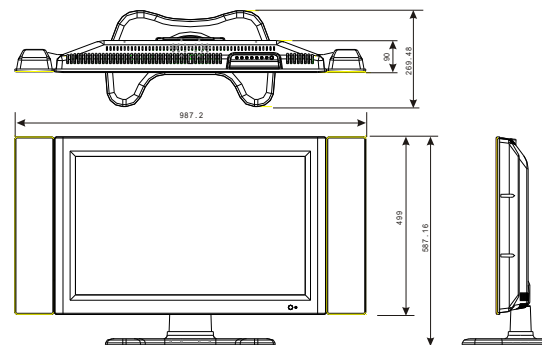

Dimensions

Control Buttons(23".27".30") LCD-2300VT,LCD-2700VT,LCD-3018VT

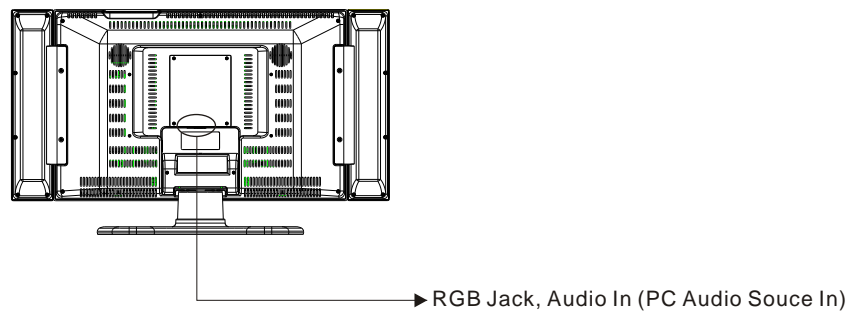
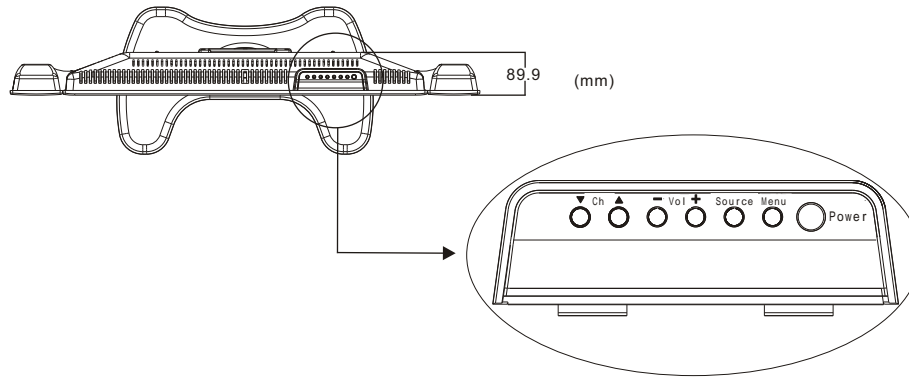



PRODUCT SPECIFICATIONS

Model		23"	27"	30"	32"	40"	42"
Picture panel		23-inch.16:9	27-inch.16:9	30-inch.15:9	32-inch.16:9	40-inch.16:9	42-inch.16:9
Resolution		1280x768	1280x720	1280x768	1366x768	1280x768	1366x768
Dimensions (mm)	W	720mm	766mm	987mm	1026mm	974mm	1024mm
	H	475mm	545mm	545mm	551mm	688mm	700mm
	D	240mm	240mm	240mm	240mm	254mm	250mm
HDTV compatible		480p/480i/720p/1080i					
Speaker		8W+8W	10W + 10W			6W + 6W	8W+8W
AC Power Supply		AC 100-240V ,50/60 Hz					
View angle		H : 170°, V : 170°					
Contrast ration(type)		600 : 1	500 : 1	600 : 1	800 : 1	600 : 1	400 : 1
Response time(Tr/Tf)		15/10 ms				14/8 ms	10/10 ms
Lamp life		50,000 hours		60,000 hours		50,000 hours	
Video Compatible		NTSC/PAL/Secam					
Remote control		R4001					
Weight(Net/Gross)		11.58/14.86Kg	13.42/16.7Kg	16.45/22.52Kg	17.0/24.3Kg	32.8/39.69Kg	36.0/45.0Kg
POWER COMSUMPTION		120W	125W	145W	170W	270W	360W

Note: No announcement for any change of design and specification.



FEATURES

- Power Saving : Save more than 40% power compared with CRT TV
- No Radiation : No radiation wave from screen.
- No Flaring Picture : No flaring picture which may hurt users' eyes
- Thinner and lighter : space saving, better for decoration
- No Static Electricity : LCD panel does not create static electricity
- Excellent Sound Effects : High performance speakers

MULTI-MEDIA BOX

Audio	MTS	YES
	Surround	YES
Connectors	S-Video	2 SET
	AV Input	2 SET
	TV Input	1 SET
	YCbCr	1 SET
	HDTV	1 SET
	VGA Audio Input	1 SET
	Audio Output	1 SET
	DVI	1 SET
Supporting Connectors	AV I/O Connector Video1vp-p(75ohms) Audio0.4rms(47Kohms) S-Video: Brightness:1vpp(75ohms), Color:0.3VPP(75ohms)	

PRODUCT INSTALLATION WITH MULTI-MEDIA BOX

1. Antenna Installation

- Make sure multi-media box has been installed correctly.
- Please connect antenna cable to Multi-media box's tuner head ANT (Refer to figure 1 on page 12)
- Please do not install antenna in raining or thundering condition

Caution : Please use legal cable TV, otherwise it may damage the product. It may also void warranty.

2.VGA Source Connection:

- Please switch off PC and TV. Connect VGA cable to display's D-Sub connector, and connect the other head of cable to PC VGA Output

3.DVI Source Connection:

Use DVI cable to connect with PC and TV

- You can use this display to play with a Video player, Video Camera, DVD Player, and TV Game consoles etc.
- Please connect to Y.Cb.Cr (Digital signals) if the external devices has Y.Cb.Cr outputs
- Please connect to correct video and audio jacks with external devices.
- This TV provides audio output jack (Audio OUT) which allows connection with external speakers or stereo.
- Please purchase standard signal cables
- Please switch off the TV before setting up additional equipments.

4.High Definition TV (HDTV)source connection:

This TV provides one Y.Cb.Cr-VGA cable and one audio cable.for HDTV, please connect Y.Cb.Cr-VGA cable to Y.Cb.Cr jacks, and connect the other head of cable to D-SUB connector. For HDTV audio, please connect the audio cable to PC Audio In jack at the back of the TV.

5.Speaker Jack(Audio Out):

Use for external speakers or stereo.

6.Power Connection:

- Please use correct socket outlet.
- Please unplug the power cord if theTV will not be used for a long period of time.

SOURCE INPUT CONNECTORS

Multi-media box

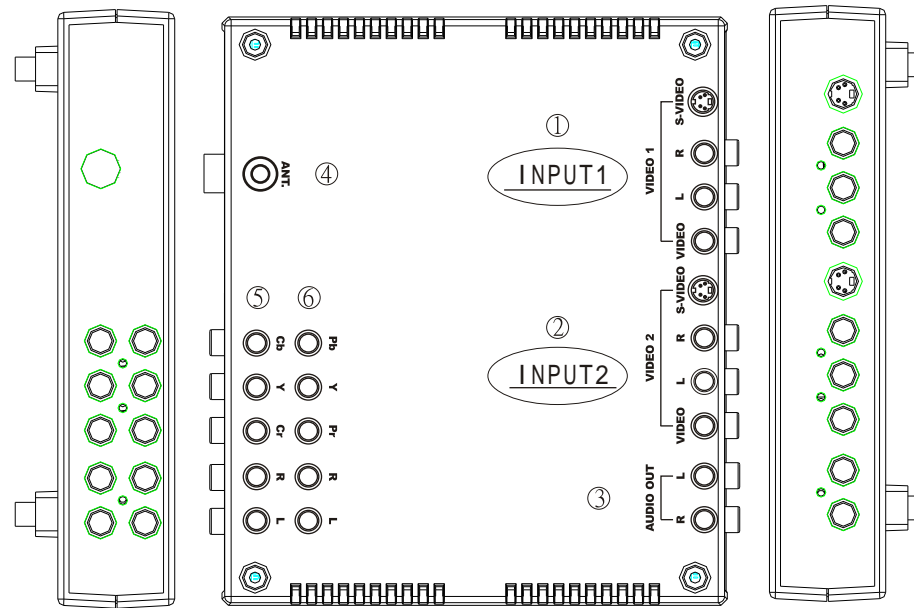

Connectors	Description
① AV.S-Video In ② Input 1、 Input 2	Video Input is using Video Jack(Yellow RCA Jack)or S-Video Jack. Audio Input is using White RCA Jack (Left) and Red RCA Jack (Right)
③ Audio Out	The level of audio output cannot be changed using the volume, treble and bass controls on your display.This connector should be used with an external audio amplifier that can be used to control the volume
④ ANT	Receive TV Source
⑤ SDTV Input	Support 480i. 576i. Signal
⑥ HDTV Input	Support 480P. 576P.720P and 1080i Signal

REMOTE CONTROL

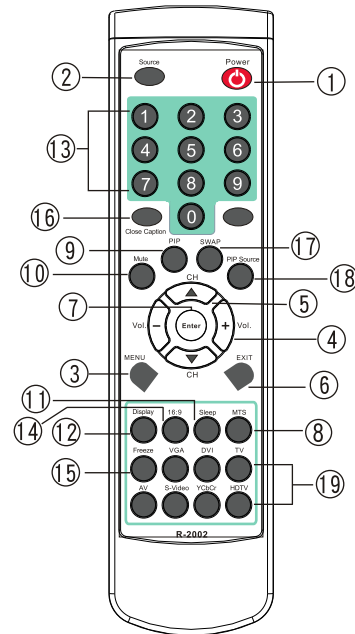

- (1) Power
- (2) Source:
Select source input
- (3) Menu:
Select from PICTURE
PARAMETERS/AUDIO
SETTING/PICTURE IN
PICTURE/PARENTAL
CONTROLS/GENERAL
SETTINGS. Use (+)(-) to
select desired
program and press ENTER ⑦
to proceed. Use ▲▼Ⓜ⑤ and +- ④④
to select function that need
to be adjusted.
- (4) VOL:
(+)for volume up and
(-)for volume down
- (5) CH:
Use CH(▲▼) to change
channels
- (6) Exit:
Back to previous
channel or program

(7)Enter :
Under menu mode,press this key to confirm and proceed the
program or function.In TV Mode,it can be used to switch back to
the previous channel

(8)MTS/NICAM :
Switch to Mono,SAP

(9)PIP :
Switch to PIP or POP

- (10)Mute:
Switch On/Off sound off function
- (11)Sleep:
Set timer to 30/60/120 min.
- (12)Display:
To display the informations at top right corner
- (13)Digit Buttons:
Switch to favorite channel directly by entering the channel numbers
- (14)16:9:
Switch to 4:3 or 16:9 display format
- (15)Freeze:
Freeze the display image
- (16)Close Caption:
Switch On/Off sub-title function
- (17)Swap:
Swap input sources between main display and sub-display
- (18)PIP Source:
To show PIP function on the screen
- (19)Direct Keys:
Access to PC/DVI/TV/(AV1andAV2)/(S-Video1andS-Video2) /Y.Pb.Pr/HDTV directly



REMOTE CONTROL PRECAUTION & USAGE

- Remote distance will be shorter as the signal receiver is facing a strong light.
- All impacts should be avoided
- Humidity and high temperature conditions should be avoided
- Remove batteries from remote control if it not in use for a long time
- Remote control should point directly to the TV signal receiver

● PC (RGB) MODE

IMPORTANT:

1.If PC picture interferences appeared while RGB and antenna are connecting to the display at the same time. This is possibly caused by PC and display both are using different number of plugging heads, such as 2 heads and 3 heads. Users are advised to use the same number of plugging heads for both PC and display.

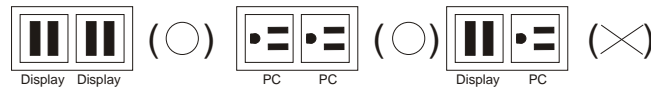

● PC Mode Adjustment

Key Pad

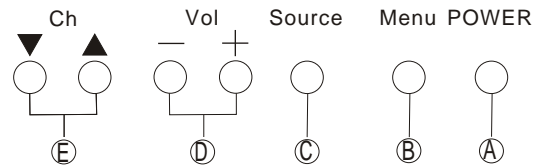

- 1.Press ③ or ② button to get Menu list
- 2.Use ① ④ buttons to select options
- 3.Use Enter ⑦ button from remote control (or Source ③ button from key pad) to confirm selected adjustment option
- 4.Use ① ④ Or ② ⑤ to proceed adjustment

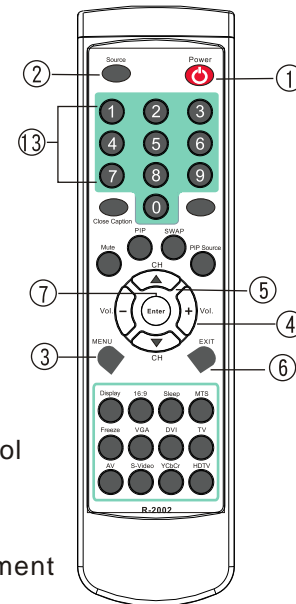

BASIC OPERATION

Key Pad

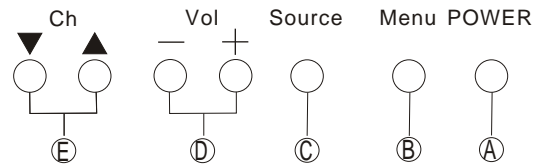

A : By using Key Pad
B : Or Remote Control

Remote Control

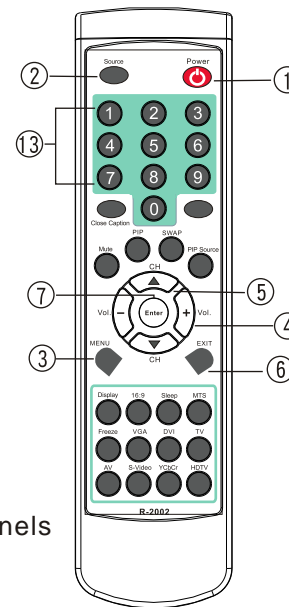

1.Channel Selection

Press Ch **5** or **E** button to search channels

2.Direct Channel Selection

Select favorite channels directly by pressing channel numbers. For example, Ch45. Press 4 and followed by 5

3.Antenna/Cable TV Setup

Menu → CHANNEL SETTINGS → System → ANTENNA/
CABLE

4.Auto Scan

Menu → CHANNEL SETTINGS → CH EDIT → AUTO

5.Press POWER button to stop auto-scan process

AUDIO SETTINGS

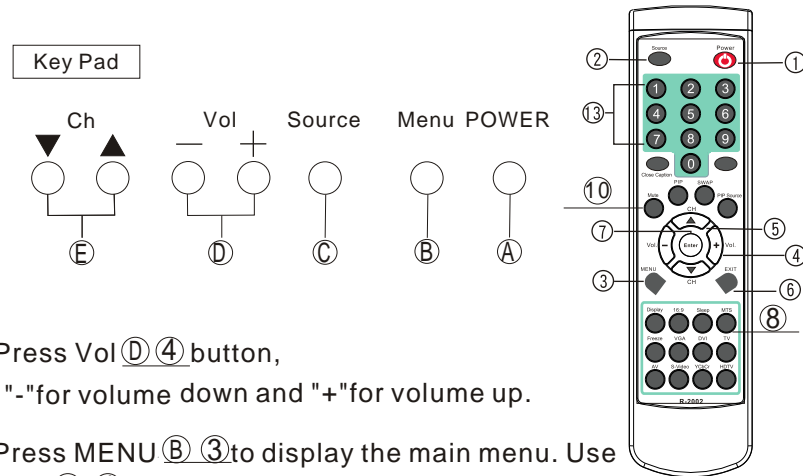

1. Press Vol **(D) (4)** button,
 "-" for volume down and "+" for volume up.
 2. Press MENU **(B) (3)** to display the main menu. Use
 Vol **(E) (4)** to select audio settings.
 3. Press **(C) (7)** to enter Audio Settings menu. Use **(E) (5)**
 Buttons to select (Bass/Treble/Balance/MTS/Mute)
 4. Press **(D) (4)** buttons to perform adjustment. Press MENU **(B) (3)**
 button to exit.
- Balance : Sound Balance adjustment
 Bass : Bass sound frequency adjustment
 Treble : Treble sound frequency adjustment
5. MUTE : Press Mute button **(10)** from remote control
 to switch On/Off the sound
 (Refer to pg. 14 for Remote Control Description)
 6. MTS : Press MTS button **(8)** from remote control,
 You are able to select fuctions of Mono, and Nicam
 (Refer to pg. 14 for Remote Control Description)

Note : MTS/NICAM only works in TV mode

PICTURE PARAMETERS

● BRIGHTNESS

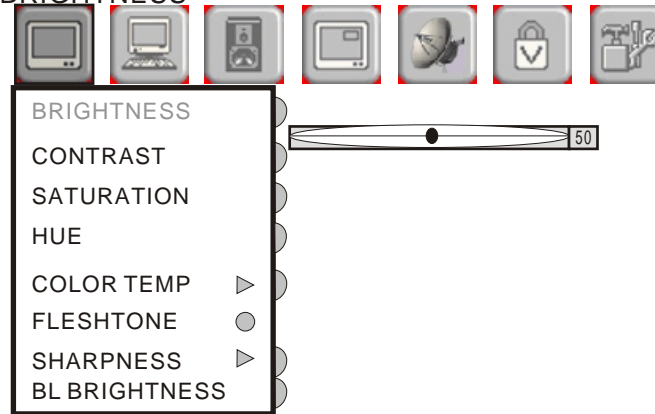

1. Press MENU **(B)** **(3)** button to display the main menu
2. Press Enter **(C)** **(7)** button to select (PICTURE PARAMETERS) option
3. Select BRIGHTNESS and press **(D)** **(4)** to perform adjustment.

● CONTRAST



1. Press MENU **(B)** **(3)** button to display the main menu
2. Press Enter **(C)** **(7)** button to select (PICTURE PARAMETERS) option
3. Press **(E)** **(5)** button to select CONTRAST and use **(D)** **(4)** to adjust.

PICTURE PARAMETERS

SATURATION



1. Press MENU **(B)** **(3)** button to display the main menu
2. Press Enter **(C)** **(7)** button to select (PICTURE PARAMETERS) option
3. Press **(E)** **(5)** button to select SATURATION and use **(D)** **(4)** to adjust.

HUE

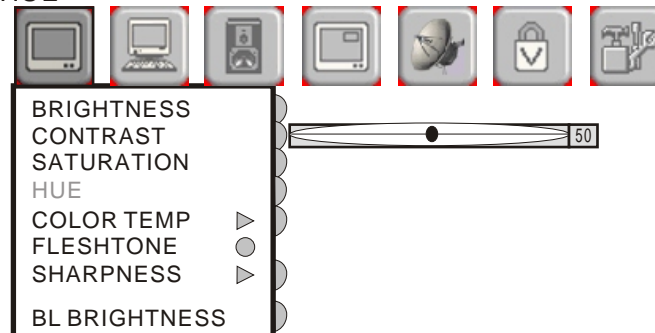

1. Press MENU **(B)** **(3)** button to display the main menu
2. Press Enter **(C)** **(7)** button to select (PICTURE PARAMETERS) option
3. Press **(E)** **(5)** button to select HUE and use **(D)** **(4)** to adjust.

PICTURE PARAMETERS

FLESH TONE

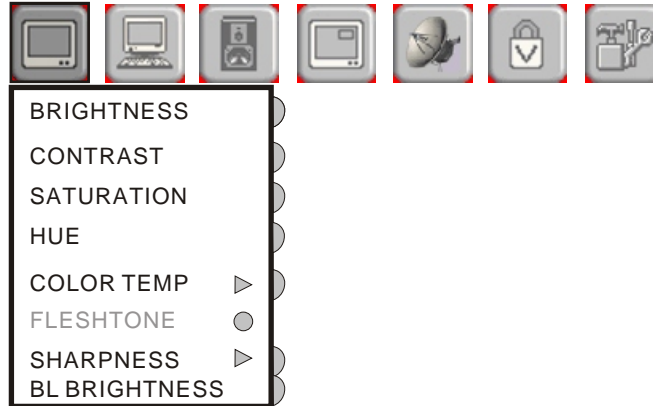

1. Press MENU **(B)** **(3)** button to display the main menu
2. Press Enter **(C)** **(7)** button to select (PICTURE PARAMETERS) option
3. Press **(E)** **(5)** button to select FLESH TONE press Enter **(C)** **(7)** to adjust

SHARPNESS

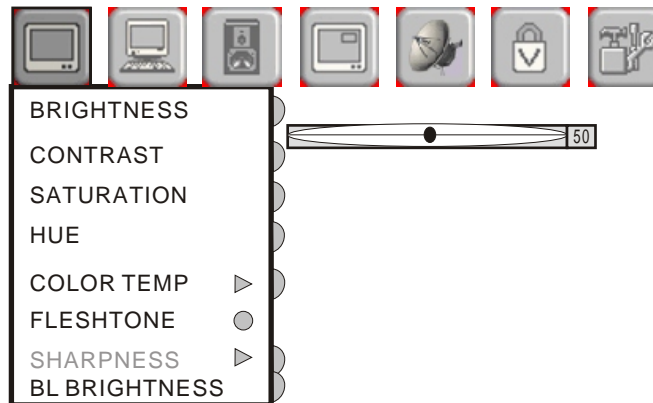

1. Press MENU **(B)** **(3)** button to display the main menu
2. Press Enter **(C)** **(7)** button to select (PICTURE PARAMETERS) option
3. Press **(E)** **(5)** button to select SHARPNESS and use **(D)** **(4)** to adjust.

PC PARAMETERS

● AUTO

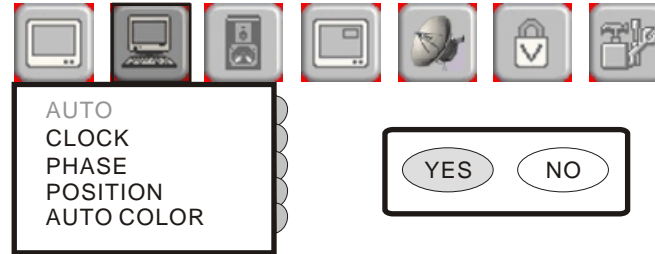

1. Press MENU **(B) (3)** button to display the main menu
2. Press **(E) (4)** button to select(PC PARAMETERS) option
3. Press Enter **(C) (7)** button to select AUTO
4. Press Enter again and use **(D) (4)** to select (YES / NO)

● CLOCK

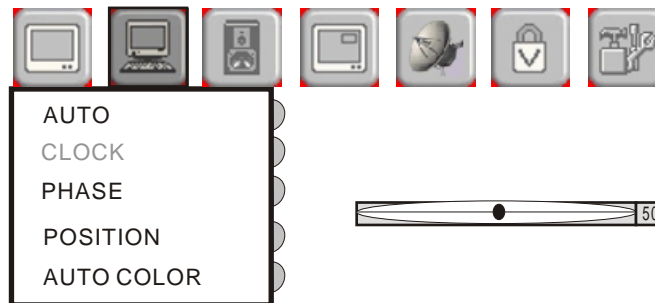

1. Press MENU **(B) (3)** button to display the main menu
2. Press **(E) (4)** button to select(PC PARAMETERS) option
3. Press Enter **(C) (7)** button to select CLOCK
4. Press **(D) (4)** to adjust

PC PARAMETERS

● PHASE

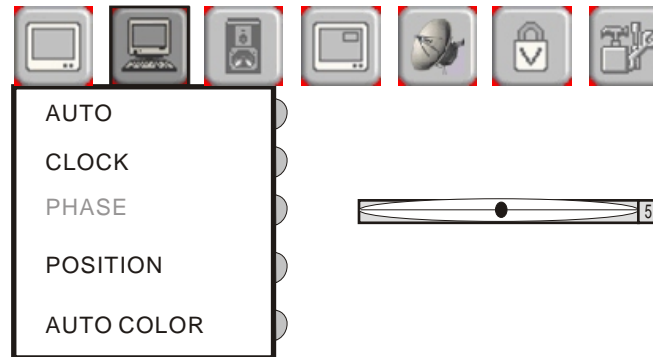

1. Press MENU **(B)** **(3)** button to display the main menu
2. Press **(E)** **(4)** button to select(PC PARAMETERS) option
3. Press Enter **(C)** **(7)** button to select PHASE
4. Press **(D)** **(4)** to adjust

● POSITION

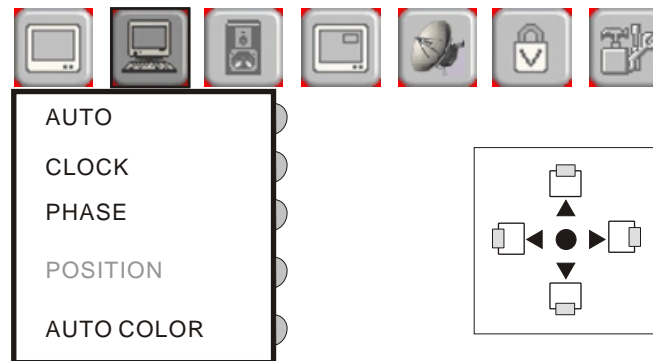

1. Press MENU **(B)** **(3)** button to display the main menu
2. Press **(E)** **(4)** button to select(PC PARAMETERS) option
3. Press Enter **(C)** **(7)** button then press **(E)** **(5)** to select POSITION
4. Press Enter again and use **(D)** **(4)** and **(E)** **(5)** to adjust

PC PARAMETERS

● AUTO COLOR

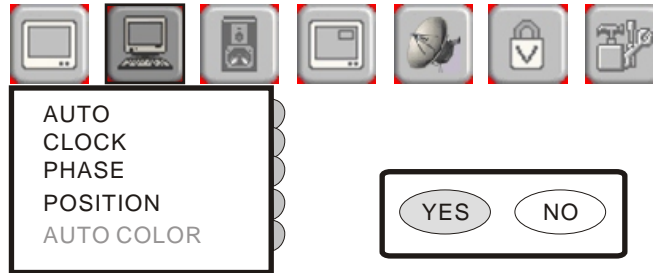

1. Press MENU **(B) (3)** button to display the main menu
2. Press **(E) (4)** button to select(PC PARAMETERS) option
BL BRIGHTNESS
3. Press Enter **(C) (7)** button then **(E) (5)** to select AUTO COLOR
4. Press Enter again and use **(D) (4)** to select (YES / NO)

AUDIO SETTINGS

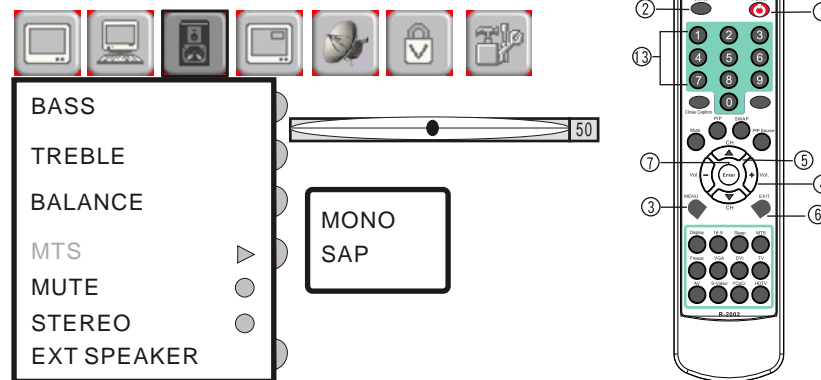

1. Press MENU **(B) (3)** button to display the main menu
2. Press **(E) (4)** button to select(AUDIO SETTINGS) option
3. Press Enter **(C) (7)** button then **(E) (5)** to select required option
4. Press Enter again and use **(D) (4)** or **(E) (5)** to adjust

PICTURE-IN-PICTURE

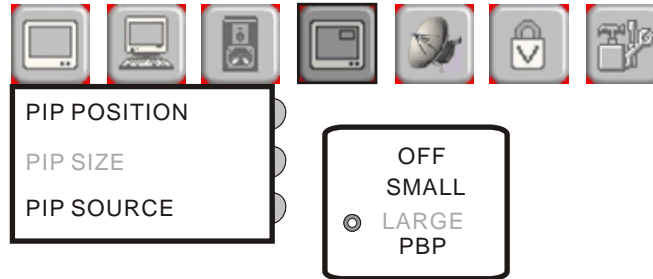

1. Press MENU **(B) (3)** button to display the main menu
2. Press **(E) (4)** button to select (PICTURE-IN-PICTURE) option
3. Press Enter **(C) (7)** or **(E) (5)** button to select
(PIP POSITION / PIP SIZE / PIP SOURCE)
4. Press Enter **(C) (7)** button and use **(D) (4)** and **(E) (5)** to select
(OFF / SMALL / LARGE / PBP)

PICTURE-IN-PICTURE

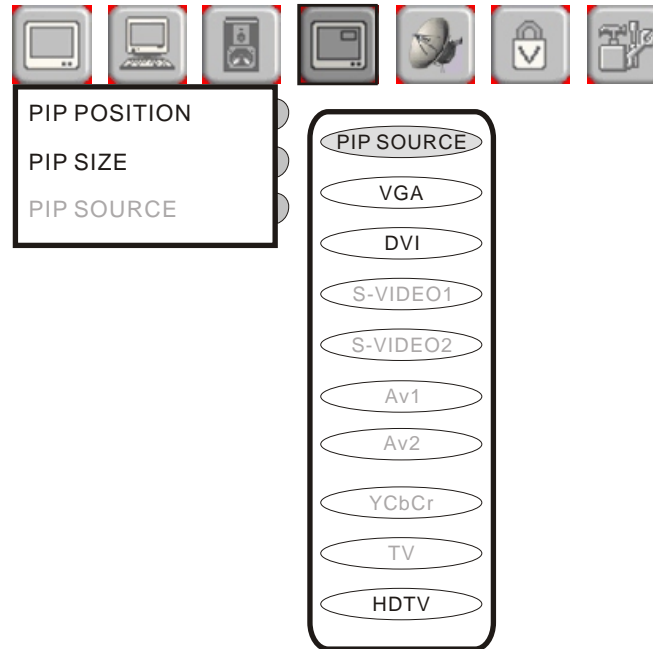

1. When the main screen is display under the VGA or HDTV mode either (DVI-S-video1/S-video2/AV1/AV2/YCbCr/TV) is selectable for sub-screen display.
2. (VGA and HDTV source are not viewable at the same time)
3. When the main screen is display under the DVI mode either (VGA/S-video1/S-video2/AV1/AV2/YCbCr/TV/HDTV) is selectable for sub-screen display.
4. When the main screen is display under the S-video1/S-video2/AV1/AV2/YCbCr/TV mode either (VGA/DVI/HDTV) is selectable for sub-screen display.

PICTURE SOURCE SETUP

Picture source setup

Main source PIP source	VGA	DVI	Sv1	Sv2	Av1	Av2	YCbCr	TV	HDTV
VGA	✗	○	○	○	○	○	○	○	✗
DVI	○	✗	○	○	○	○	○	○	○
Sv1	○	○	✗	✗	✗	✗	✗	✗	○
Sv2	○	○	✗	✗	✗	✗	✗	✗	○
Av1	○	○	✗	✗	✗	✗	✗	✗	○
Av2	○	○	✗	✗	✗	✗	✗	✗	○
YCbCr	○	○	✗	✗	✗	✗	✗	✗	○
TV	○	○	✗	✗	✗	✗	✗	✗	○
HDTV	✗	○	○	○	○	○	○	○	✗

Remark:

"○" Represent a playable source

"✗" Represent a non-playable source

CHANNEL SETTINGS

● ANTENNA AND CABLE TV SELECTION

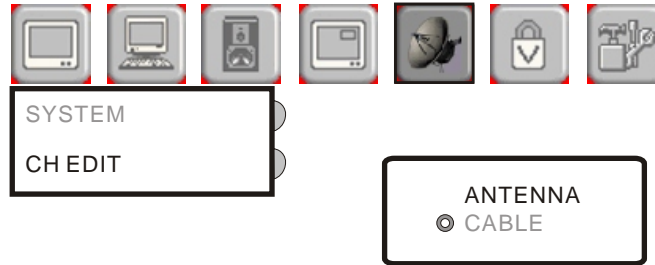

1. Press MENU **(B)** **(3)** button to display the main menu
2. Press **(E)** **(4)** button to select(CHANNEL SETTINGS)
3. Press Enter **(C)** **(7)** button to select SYSTEM
4. Press Enter again and use **(E)** **(5)** to select(ANTENNA / CABLE)

● CHANNELS AUTO-SCAN

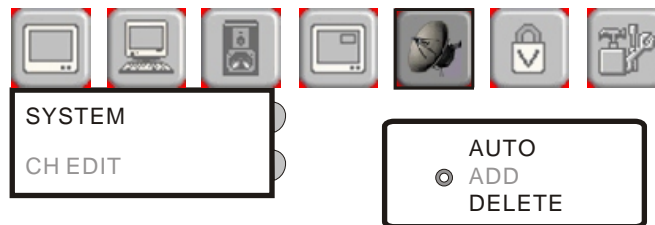

1. Press MENU **(B)** **(3)** button to display the main menu
2. Press **(E)** **(4)** button to select(CHANNEL SETTINGS)
3. Press Enter **(C)** **(7)** button then **(E)** **(5)** to select CH EDIT
4. Press Enter again and use **(E)** **(5)** to select(AUTO/ADD/DELETE)

PARENTAL CONTROLS

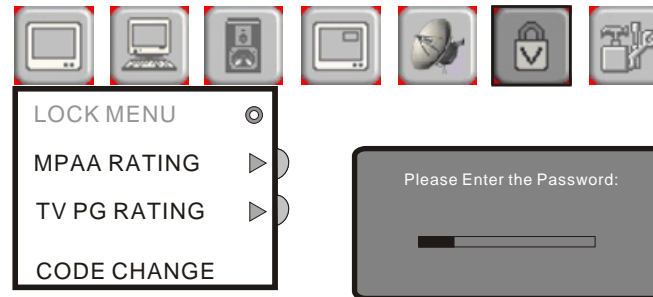

1. Press MENU **(B)** **(3)** button to display the main menu
2. Press **(E)** **(4)** button to select(PARENTAL CONTROLS)
3. Press Enter **(C)** **(7)** button then **(E)** **(5)** to select required option
4. Press Enter again and use **(D)** **(4)** **(E)** **(5)** and number button to adjust.
5. Press default password was "1111", you can change your password with the icon "code change".

GENERAL SETTINGS

● OSD TIMEOUT

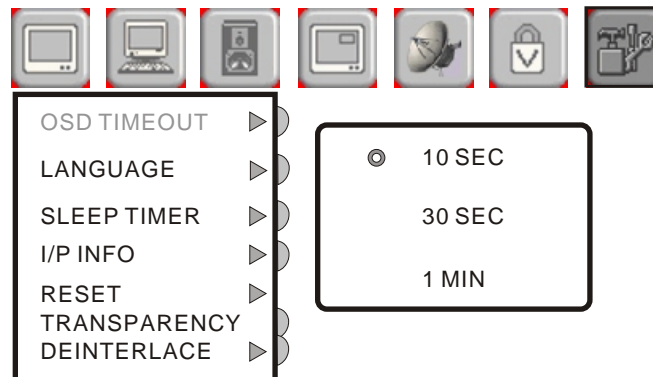

1. Press MENU **(B)** **(3)** button to display the main menu
2. Press **(E)** **(4)** button to select(GENERAL SETTINGS)
3. Press Enter **(C)** **(7)** button to select OSD TIMEOUT
4. Press Enter again and use **(E)** **(5)** to select(10SEC/30SEC/1MIN)

GENERAL SETTINGS

●LANGUAGE

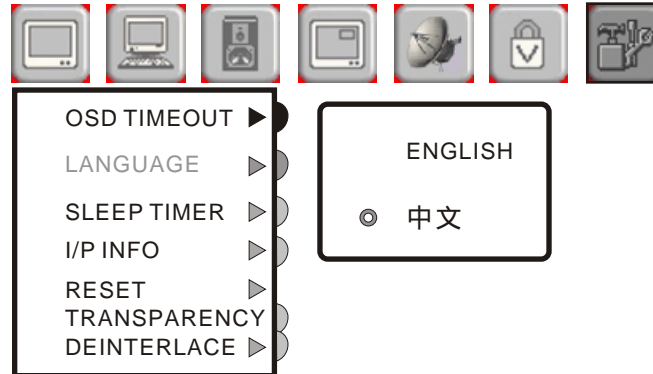

1. Press MENU **(B)** **(3)** button to display the main menu
2. Press **(E)** **(4)** button to select(GENERAL SETTINGS)
3. Press Enter **(C)** **(7)** button then **(E)** **(5)** to select required option
4. Press Enter again and use **(E)** **(5)** to select
(ENGLISH/CHINESE 中文.)

●SLEEP TIMER

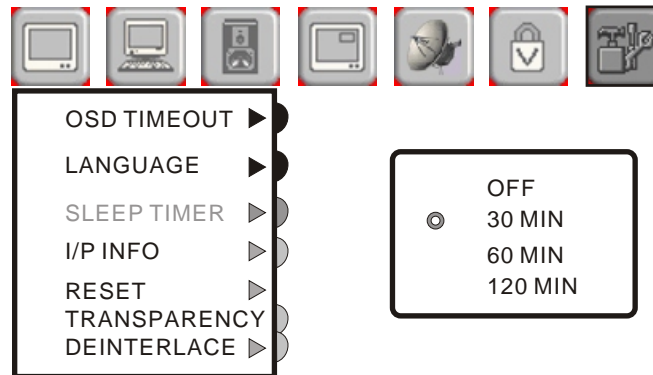

1. Press MENU **(B)** **(3)** button to display the main menu
2. Press **(E)** **(4)** button to select(GENERAL SETTINGS)
3. Press Enter **(C)** **(7)** button then **(E)** **(5)** to select SLEEP TIMER
4. Press Enter again and use **(E)** **(5)** to select (OFF / 30MIN / 60MIN / 120MIN)

GENERAL SETTINGS

● I/P INFO

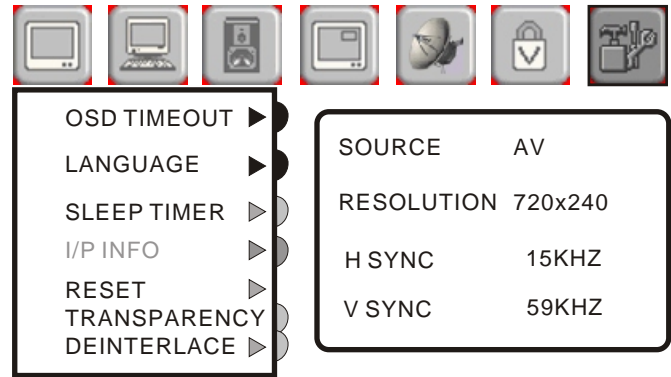

1. Press MENU **B** **3** button to display the main menu
2. Press **E** **4** button to select(GENERAL SETTINGS)
3. Press Enter **C** **7** then **E** **5** and the information will display on screen

● RESET

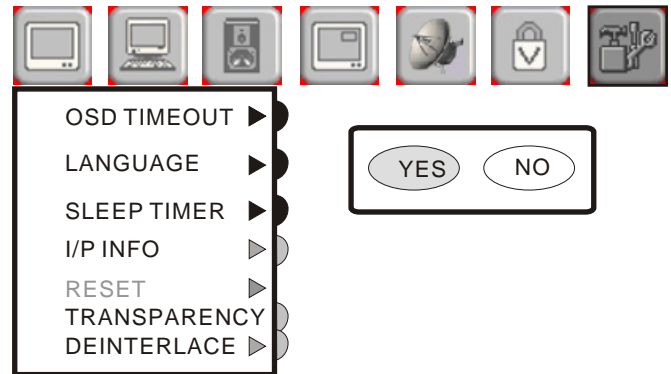

1. Press MENU **B** **3** button to display the main menu
2. Press **E** **4** button to select(GENERAL SETTINGS)
3. Press Enter **C** **7** button then **E** **5** to select RESET
4. Press Enter again and use **D** **4** to select (YES / NO)

GENERAL SETTINGS

● TRANSPARENCY

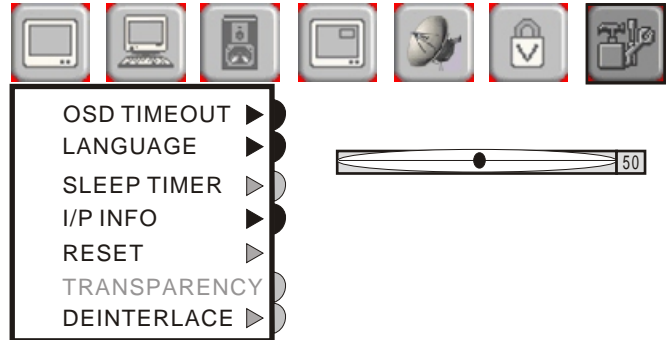

1. Press MENU **B** **3** button to display the main menu
2. Press **E** **4** button to select(GENERAL SETTINGS)
3. Press Enter **C** **7** button then **E** **5** to select TRANSPARENCY
4. Press and use **D** **4** to adjust

● DEINTERLACE

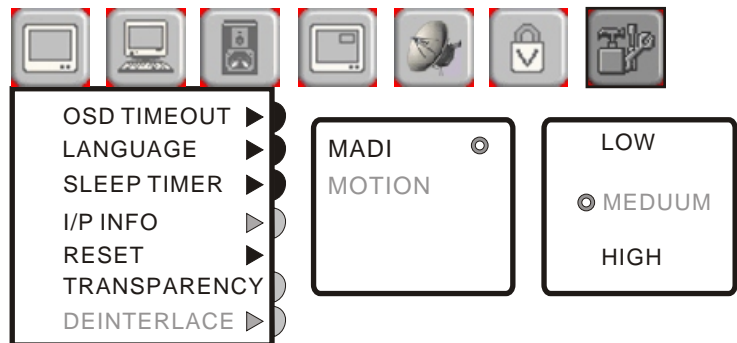

1. Press MENU **B** **3** button to display the main menu
2. Press **E** **4** button to select(GENERAL SETTINGS)
3. Press Enter **C** **7** button then **E** **5** to select DEINTERLACE
4. Press Enter **C** **7** then **E** **5** to select MOTION
5. Press Enter again then **E** **5** to select (LOW / MEDUUM / HIGH)



GENERAL SETTINGS

- DEINTERLACE

- 1.MADI(Motion Adaptive De-interlacing)

Video processing with this de-interlacing, recommend in TV, AV and S-video mode.

- 2.Motion:

Video processing in motion picture.

Low: Exhibits very little flickering.

Medium: Between low and high.

High: Minimize or eliminate the feathering artifact.

ONE YEAR LIMITED WARRANTY

ToteVision warrants to the original purchaser that this product is free from defects in workmanship and material under normal use and conditions for a period of 1 year from the date of original purchase,subject to the limitations below. Should service be required by reason of any defect or malfunction during the warranty period,ToteVision will repair or at its discretion replace this product,, without charge(except for a \$15.00 charge for handling,packing,return shipping,and subject to verification of the defect or malfunction), upon delivery of this product to the Factory Service Center listed below with proof of date of purchase.During the warranty period ToteVision will repair or replace,free of charge,defective units WHICH ARE NOT DEFECTIVE DUE TO ORDINARY WEAR AND TEAR, USER ABUSE, OR OTHER CAUSES NOT ARISING OUT OF MANUFACTURER'S DEFECTS IN MATERIALS OR WORKMANSHIP.

Before returning this product for service:

1. If it is necessary to pack the unit in other than original carton and protectors,please insure proper packaging for good protection.
2. Enclose a photocopy of your dated sales receipt, credit card statement, or other proof of the date of purchase, a description of your complaint, your name, address and day time telephone number. (Do not use P.O Box numbers since UPS cannot deliver to P.O. Boxes.) Your warranty registration information must be on file in our office as a method of identification. If Proof of original ownership is not in our records, the repairs will be treated as "out-of-warranty" and your unit will be returned to you C.O.D. For repair and handling charges.
3. For "In Warranty repairs" enclose a check or money order payable to the order of Tote Vision for the sum of \$15.00 for return postage and handling.
4. Ship the unit prepaid to the Factory Service Center listed below.
5. If your unit needs service after the warranty period has expired,ship it prepaid and insured to the Factory Service Center below.

Enclose a description of your complaint:your name,company name,address,and day time telephone number,You will be advisd of estimated repair charges.

NOTE:This warranty is valid only if the product is used for the purpose for which it was designed. It does not cover:

- (i) products which have been damaged by negligence,misuse, accidents,abuse,acts of God, or units which have been modified or repaired by unauthorized persons,
- (ii) cracked or broken units damaged by excessive heat or cold, or units exposed to excessive UV light.
- (iii) products which havetheir serial numbers removed,altered or rendered illegible,
- (iv) products that have been in constant use (24 hours per day, 7 days per week)that have cold cathode florescent tubes(CCFT) that do not provide sufficient illumination,
- (v) the cost of shipping this product to the Factory Service Center and its return to you.

No warranty,expressed or implied,as to merchantability or fitness for a particular use is made beyond this Limited Warranty. Tote Vision will not be liable for incidental or consequential damages or lost profits arising form product defects or malfunctions. This warranty is valid only in the United States of America and does not extend to owners of the product subsequent to the original purchaser.Any applicable implied warranties are also limited to 1 year and Tote Vision will not be liable for consequential damages. (Some states do no allow limitations on implied warranties or exclusions of consequential damages,so that thes restrictions may not apply to you.) This warranty gives you specific legal rights,and you may also have other rights which vary from state to state.

As a precondition to receiving any of the benefits of this limited warranty,your completed warranty registration information must be on file in our office. IF YOUR INFORMATION IS NOT ON FILE WITH US, ALL WARRANTY CLAIMS WILL BE DENIED. TO PROTECT YOUR WARRANTY, MAIL YOUR REGISTRATION INFORMATION TODAY! Submission of a unit determined not defective will result in a charge to you for testing and handling the unit. Thoroughly test your unit before submitting it for warranty claim repair.

Send unit to : TOTEVISION SERVICE CENTER 1319 Dexter Avenue N.#020,Seattle, Wa98109

For further information: call (206) 623-6000 fax (206) 623-6609

WARRANTY REGISTRATION

Protect your Warranty by completing and mailing this form to : ToteVision,1319 Dexter Avenue N.# 020, Seattle, Wa98109

Model Number: _____ Serial Number: _____

Name: _____

Address: _____

City: _____ State: _____ Zip: _____

Telephone number: (_____) _____

Dealer: _____ Dealer City: _____ State: _____