



TOSHIBA

**WL66/67
EL66/67
DL66/67
Series**

Owner's manual

REGZA

Contents



SETTING UP

Safety precautions – Some do's and don'ts for you to be aware of	3
Installation and important information	4
The remote control – an at-a-glance guide	5
Connecting external equipment – a guide to connecting external equipment to the back of the television	6
Connecting a computer – connecting a computer to the back of the television	7
Controls and input connections – switching on the television, standby, using the controls, headphone socket, connecting equipment to the side input sockets	8
Tuning the television using Quick Setup – language, country	9
Sorting programme positions	9
Manual tune – an alternative to <i>Quick Setup</i> , direct entry of channels, tuning a programme position for a media recorder	10
Programme skip	11
Auto tune	12

CONTROLS AND FEATURES

General controls – changing programme position	12
Sound controls – volume, sound mute, bass/treble/balance	12
Sound controls – bass boost, dual, stable sound®	13
SRS WOW™ sound effects – SRS 3D, FOCUS, TruBass	13
Widescreen viewing	14
Picture controls – picture position, back light	16
Picture controls – picture preferences (contrast, brightness, colour, tint, sharpness), black stretch, MPEG noise reduction (MPEG NR), digital noise reduction (DNR)	17
Picture controls – colour temperature, 3D colour management, base colour adjustment	18
Picture controls – cinema mode, automatic format (widescreen), blue screen, side panel adjustment	19
Panel lock – disabling the buttons on the television	20
Time display	20
Stereo and bilingual transmissions – stereo/mono or dual language broadcasts	20
The timer – setting the television to turn on and off	20
PC Setting – picture position, clock phase, sampling clock, reset	21
Input selection and AV connections – input and output sockets for connected equipment	22

TEXT SERVICES

Setting up, general information, Auto. and LIST modes	24
Control buttons	25

PROBLEM SOLVING

Questions and Answers – answers to some of the more common queries including manual fine tuning and colour system	26
--	----

INFORMATION

Specifications and Accessories – technical information about the television, supplied accessories	28
--	----

Safety Precautions

This equipment has been designed and manufactured to meet international safety standards but, like any electrical equipment, care must be taken to obtain the best results and for safety to be assured. Please read the points below for your own safety. They are of a general nature, intended to help with all electronic consumer products and some points may not apply to the goods you have just purchased.

Air Circulation

Leave at least 10cm clearance around the television to allow adequate ventilation. This will prevent overheating and possible damage to the television. Dusty places should also be avoided.

Heat Damage

Damage may occur if the television is left in direct sunlight or near a heater. Avoid places subject to extremely high temperatures or humidity. Place in a location where the temperature remains between 5°C (41°F) min. and 35°C (94°F) max.

Mains Supply

The mains supply required for this equipment is 220-240v AC 50/60Hz. Never connect to a DC supply or any other power source. DO ensure that the television is not standing on the mains lead. DO NOT cut off the mains plug from this equipment, this incorporates a special Radio Interference Filter, the removal of which will impair its performance. In the UK, the fuse fitted in this plug is approved by ASTA or BSI to BS1362. It should only be replaced by a correctly rated and approved type and the fuse cover must be refitted. IF IN DOUBT PLEASE CONSULT A COMPETENT ELECTRICIAN.

Do

DO read the operating instructions before you attempt to use the equipment.

DO ensure that all electrical connections (including the mains plug, extension leads and inter-connections between pieces of equipment) are properly made and in accordance with the manufacturers' instructions. Switch off and withdraw the mains plug before making or changing connections.

DO consult your dealer if you are ever in doubt about the installation, operation or safety of your equipment.

DO be careful with glass panels or doors on equipment.

DO NOT REMOVE ANY FIXED COVERS AS THIS WILL EXPOSE DANGEROUS AND 'LIVE' PARTS.

THE MAINS PLUG IS USED AS A DISCONNECTING DEVICE AND THEREFORE SHOULD BE READILY OPERABLE.

Do not

DO NOT obstruct the ventilation openings of the equipment with items such as newspapers, tablecloths, curtains, etc. Overheating will cause damage and shorten the life of the equipment.

DO NOT allow electrical equipment to be exposed to dripping or splashing or objects filled with liquids, such as vases, to be placed on the equipment.

DO NOT place hot objects or naked flame sources, such as lighted candles or nightlights on, or close to equipment. High temperatures can melt plastic and lead to fires.

DO NOT use makeshift stands and NEVER fix legs with wood screws. To ensure complete safety, always fit the manufacturers' approved stand, bracket or legs with the fixings provided according to the instructions.

DO NOT listen to headphones at high volume, as such use can permanently damage your hearing.

DO NOT leave equipment switched on when it is unattended, unless it is specifically stated that it is designed for unattended operation or has a standby mode. Switch off by withdrawing the plug, make sure your family know how to do this. Special arrangements may need to be made for people with disabilities.

DO NOT continue to operate the equipment if you are in any doubt about it working normally, or it is damaged in any way – switch off, withdraw the mains plug and consult your dealer.

ABOVE ALL – NEVER let anyone, especially children, push or hit the screen, push anything into holes, slots or any other openings in the case.

NEVER guess or take chances with electrical equipment of any kind – it is better to be safe than sorry.

Installation and important information

Where to install

Locate the television away from direct sunlight and strong lights, soft, indirect lighting is recommended for comfortable viewing. Use curtains or blinds to prevent direct sunlight falling on the screen.

Place on a sturdy platform, the mounting surface should be flat and steady. It should then be secured to the wall with a sturdy tie using the clip on the back of the stand, or secured to the platform using the fixing strap located underneath the table top stand, this will prevent it from falling over.

The LCD display panels are manufactured using an extremely high level of precision technology, however sometimes some parts of the screen may be missing picture elements or have luminous spots. This is not a sign of a malfunction.

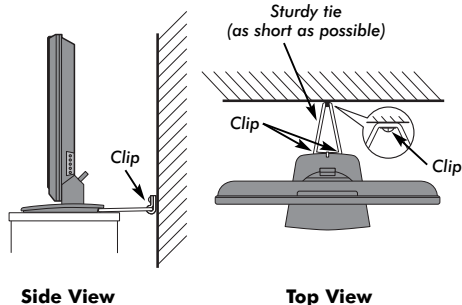

Make sure the television is located in a position where it cannot be pushed or hit by objects, as pressure will break or damage the screen, and that small items cannot be inserted into slots or openings in the case.

Please take note

EXCLUSION CLAUSE

Toshiba shall under no circumstances be liable for loss and/or damage to the product caused by:

- i) fire;
- ii) earthquake;
- iii) accidental damage;
- iv) intentional misuse of the product;
- v) use of the product in improper conditions;
- vi) loss and/or damage caused to the product whilst in the possession of a third party;
- vii) any damage or loss caused as a result of the owner's failure and/or neglect to follow the instructions set out in the owner's manual;
- viii) any loss or damage caused directly as a result of misuse or malfunction of the product when used simultaneously with associated equipment;

Furthermore, under no circumstances shall Toshiba be liable for any consequential loss and/or damage including but not limited to the following, loss of profit, interruption of business, the loss of recorded data whether caused during normal operation or misuse of the product.

If stationary images generated by text services, channel identification logos, computer displays, video games, on screen menus, etc. are left on the television screen for any length of time they could become conspicuous, it is always advisable to reduce both the brightness and contrast settings.

The remote control

Simple at-a-glance reference of your remote control.

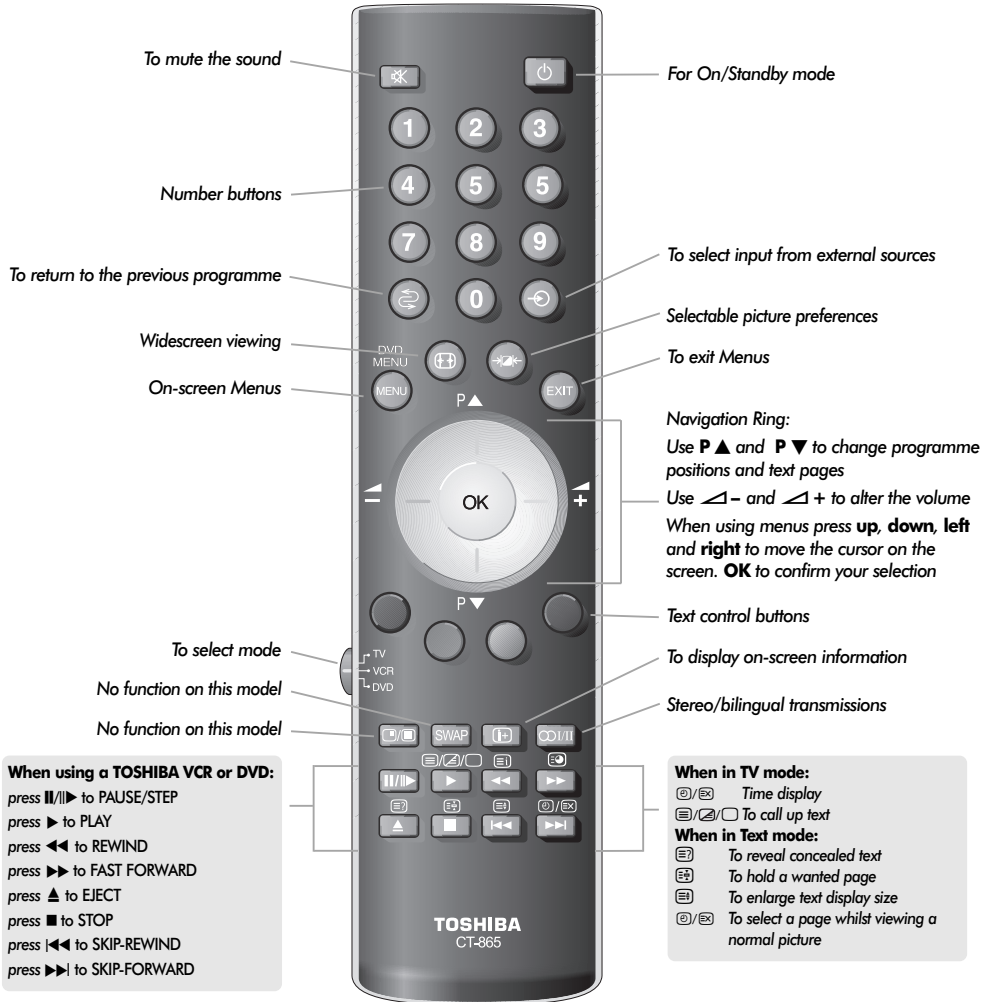

Inserting batteries and effective range of the remote

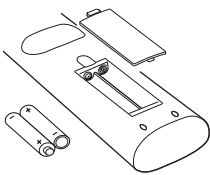

Remove the back cover to reveal the battery compartment and make sure the batteries are inserted the right way round. Suitable battery types for this remote are AAA, IEC R03 1.5V.

Do not combine a used, old battery with a new one or mix battery types. Remove dead batteries immediately to prevent acid from leaking into the battery compartment. Dispose of them in a designated disposal area.

The performance of the remote control will deteriorate beyond a distance of five metres or outside an angle of 30 degrees from the centre of the television. If the operating range becomes reduced the batteries may need replacing.

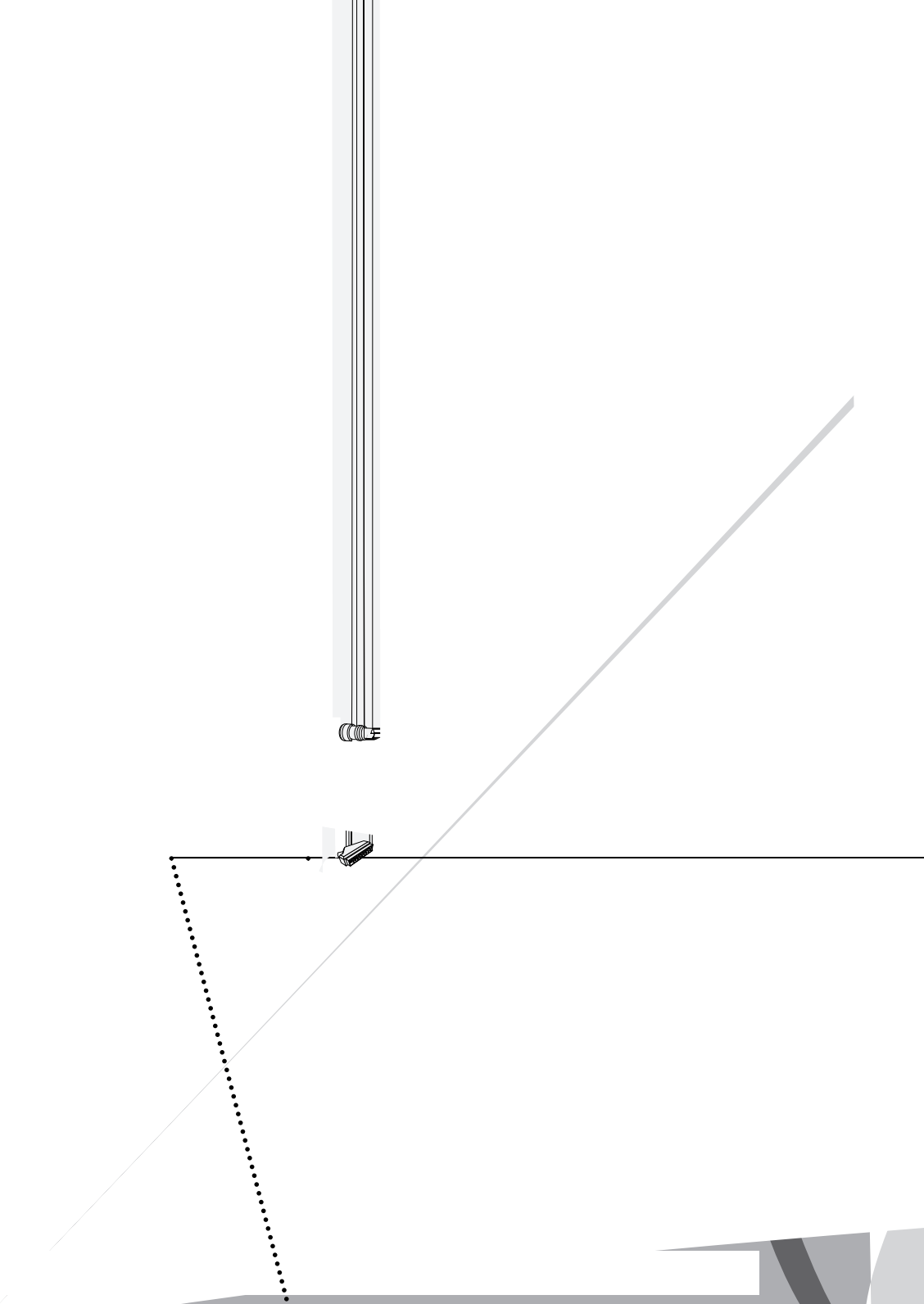

Connecting a computer

Before connecting any external equipment, turn off all main power switches. If there is no switch remove the mains plug from the wall socket.



Controls and input connections

A wide variety of external equipment can be connected to the input sockets on the side of the television. Whilst all the necessary adjustments and controls for the television are made using the remote control, the buttons on the television may be used for some functions.

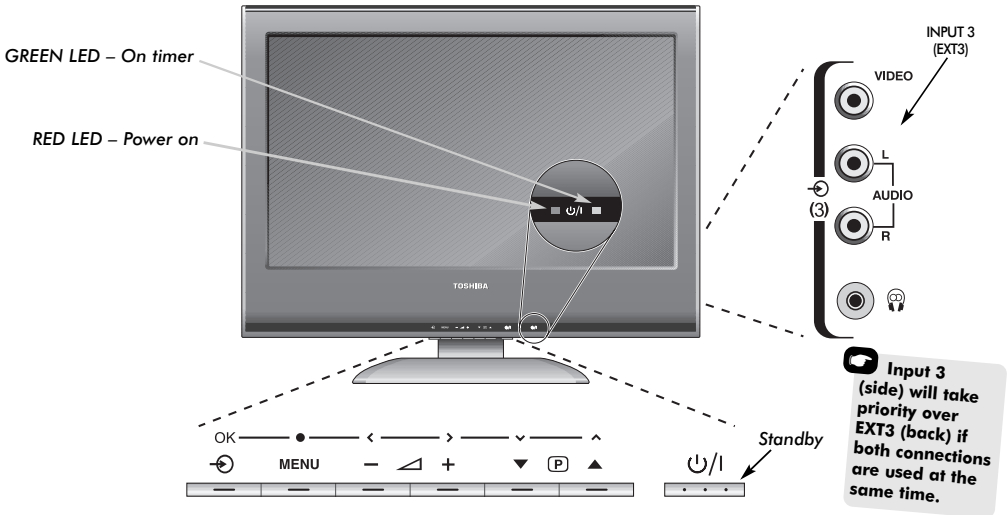

Switching on

If the RED LED is unlit check that the mains plug is connected to the power supply. If the picture does not appear press on the remote control, it may take a few moments.

To put the television into Standby press on the remote control. To view the television press again. The picture may take a few seconds to appear.

To set up the television you will now need to use the on-screen menus. Press the **MENU** button on the remote control to see the menus.

The menu bar at the top of the screens will show five different topics shown in symbols. As each symbol is selected by pressing **left** or **right** on the navigation ring on the remote control, its respective options will appear below.

To use the options, press **down** on the navigation ring to move down through them and **OK**, **left** or **right** to select the required choice. Follow the on-screen instructions. The functions of each menu are described in detail throughout the manual.

Using the controls and connections

To alter the volume press .

To alter the programme position press .

Press **MENU** and , , or to control the sound and picture options.

Press **MENU** to finish.

When connecting sound equipment to **EXT3**, connect the audio output of the equipment to the phono sockets on the television.

To select the Input, press until the display shows **EXT3** as described on page 22. The television will automatically sense the type of signal.

Please always refer to the owner's manual of the equipment to be connected for full details.

Please note: Inserting the headphone plug will mute the sound from all speakers.

Tuning the television using Quick Setup, sorting programme positions

Before switching on the television put your decoder and media recorder to **Standby** if they are connected. To set up the television use the buttons on the remote control as detailed on page 5.

- 1 Connect the television to the mains power. The **Quick Setup** screen will appear.

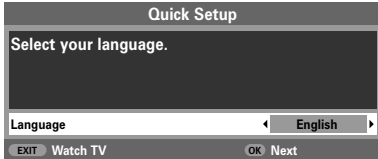

- 2 Using **left** or **right** select your **language**, then press **OK**.
- 3 Then press **left** or **right** to select your **country** and press **OK**.
- 4 To start **Auto tuning** press **OK**.

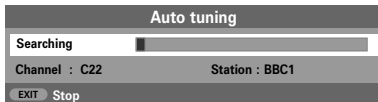

- 5 The search will begin for all available stations. The slide bar will move along the line as the search progresses.

You must allow the television to complete the search.

When the search is complete the television will automatically select programme position 1. This may not be a clear picture or the signal may be weak, so the station order can be changed using **Manual tuning** which will appear on the screen.

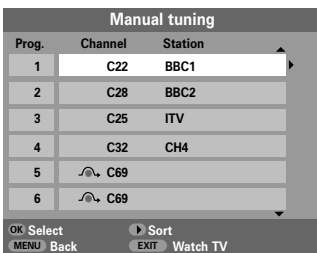

- 6 With the list of stations now showing use **up** or **down** to highlight the station you want to move and press **right**.

The selected station will be moved to the right of the screen.

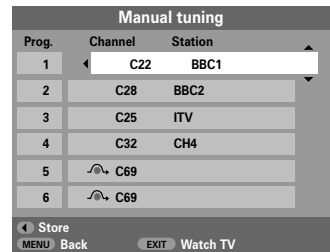

- 7 Use **up** or **down** to move through the list to your preferred position. As you do so the other stations will move to make room.
- 8 Press **right** to store your move.

Repeat as necessary, then press **EXIT**.

If the television cannot be connected to a media recorder/decoder with a SCART lead or if a station on another system is required, use **Manual tuning** to allocate a programme position, see page 10.

Manual tune

The television can be tuned-in manually using **Manual tuning**. For example: if the television cannot be connected to a media recorder/decoder with a SCART lead or to tune-in a station on another **System**.

Use *left* and *right* to move across the screen and select any of these Manual Tune options.

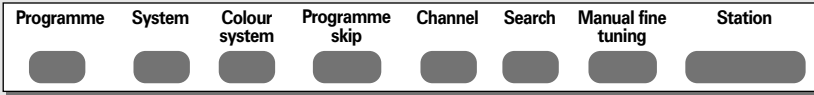

Programme: The number to be pressed on the remote control.

System: Specific to certain areas.

Colour system: Factory set to Auto, should only be changed if problems are experienced, *i.e.* NTSC input from external source.

Programme skip: means nothing has been stored or the facility to *skip* the channel is ON. See page 11.

Channel: The channel number on which a station is being broadcast.

Search: Search up and down for a signal.

Manual fine tuning: Only used if interference/weak signal is experienced. See page 26.

Station: Station identification. Use up or down and left or right to enter up to seven characters.

To allocate a programme position on the television for a decoder and media recorder: turn the decoder on, insert a pre-recorded film in the media recorder and press PLAY, then manually tune.

- 1 Press **MENU** and using **left** or **right** select the **SET UP** menu, with **down** highlight **Manual tuning**, press **OK** to select.



- 2 Use **up** or **down** to highlight the programme position required e.g. we suggest **Prog. 0** for a media recorder.

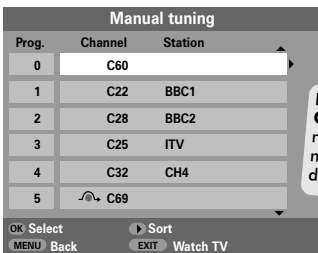

Different **Channel** numbers may be displayed

- 3 Press **OK** to select. If the programme is skipped, **Programme skip** must be removed before storing.



- 4 Press **right** to select **System** and use **up** or **down** to change if required.

- 5 Then press **right** to select **Search**.

- 6 Press **up** or **down** to begin the search. The search symbol will flash.

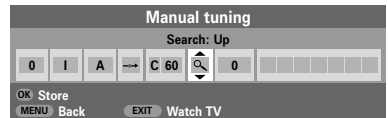

- 7 Each signal will show on the television, if it is not your media recorder, press **up** or **down** again to restart the search.

Manual tune continued,

Programme skip

- 8** When your media recorder signal is found, press **left** to move along to **Station**. With **up**, **down**, **left** and **right** put in the required characters, e.g. **VCR**.

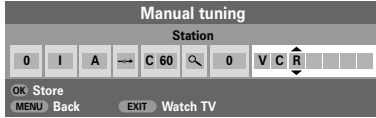

- 9** Press **OK** to store.
- 10** Repeat for each *programme position* you want to tune or, press **MENU** to return to the list of channels and select the next number to tune.
- 11** Press **EXIT** when you have finished.
- 12** To name external equipment, e.g. DVD on EXT2, press **right** to select **EXT2**, then select **Manual setting** from the **SET UP** menu.
- 13** Press **right** to select **Label** then using **up**, **down**, **left** and **right** put in the required characters.

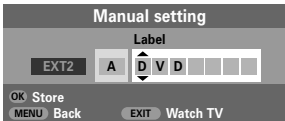

- 14** At any time by pressing **OK** a list will appear on screen showing all stored programmes and external equipment. Use **up** and **down** to highlight and **OK** to select.

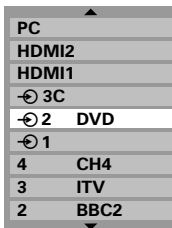

PLEASE NOTE This television has direct channel entry if the channel numbers are known. Select the **Manual tuning** screen in **Step 3**. Enter the **Programme number**, the **System**, then the **Channel** number. Press **OK** to store.

Programme skip

To prevent certain programmes from being viewed, the programme position can be skipped. The remote control must be removed as the channels will still be available using the number buttons. Programmes can then be watched as normal using the controls on the television, but the television will not show the skipped programme position.

- 1** Select **Manual tuning** from the **SET UP** menu.

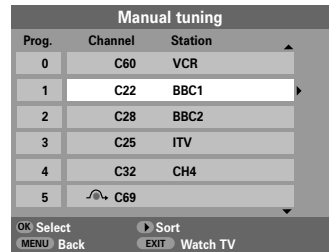

- 2** Use **up** or **down** to highlight the programme position to be skipped and press **OK** to select.
- 3** Press **right** to select **Programme skip**.
- 4** Use **up** or **down** to turn **Programme skip** on. Press **OK**.

 on the screen indicates a skipped programme position.



- 5** Press **MENU** and repeat from **Step 2** or press **EXIT**.

Each programme position has to be *individually* selected. To turn **Programme skip** off, repeat the procedure for each position.

Skipped programme positions *cannot* be selected by **P▲** and **P▼** or by the controls on the television, but *can* still be accessed by the number buttons on the remote control.

Auto tune, general controls, sound controls

Using Auto tuning

- 1 To set up the television using **Auto tuning**, press **MENU** and use **left** or **right** to select the **SET UP** menu.



- 2 Press **down** to highlight **Language** and **left** or **right** to select.
- 3 Using **down** highlight **Country**, then **left** or **right** to select. The television will now tune the stations for your country.
- 4 Press **down** to highlight **Auto tuning**, then press **OK**.

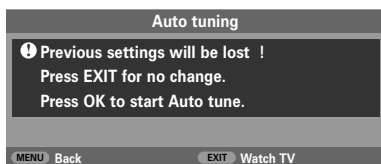

- 5 To start **Auto tuning** press **OK**.

You must allow the television to complete the search.

When the search is complete the television will automatically select programme position 1. This may not be a clear picture, so the station order can be changed using **Manual tuning**, see page 9.

Selecting programme positions

To select a programme position use the numbered buttons on the remote control.



Programme positions can also be selected using **P▲** and **P▼**.

To revert to the previous programme position press .

To display on-screen information i.e. programme position, input mode or stereo/mono signal, press . Press again to cancel.

Sound controls

Volume

Press  or  to adjust the volume.

Sound Mute

Press  once to turn the sound off and again to cancel.

Bass, Treble and Balance

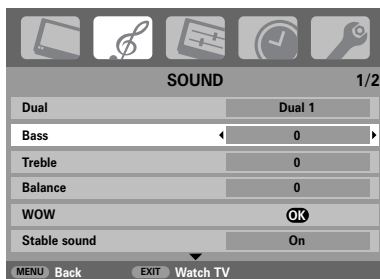

- 1 Press **MENU** and **left** or **right** to select **SOUND**.
- 2 Press **down** to highlight **Bass**, **Treble** or **Balance** and **left** or **right** to change the setting.

Sound controls continued, SRS WOW™ sound effects, dual, stable sound®

When connecting to a Hi-fi unit, set the **Speaker** option to **Off**. Then select **Fixed** or **Variable** for the **Monitor (Audio)** in the **AV connection** menu. (See 'Input Selection and AV Connections' section).

SRS WOW™ sound effects

SRS WOW™ is a suite of audio effects which use the stereo signals being broadcast to produce enhanced sound from the television's speakers. If mono sound is broadcast only TruBass will be available.

SRS 3D gives a rich sound experience, **FOCUS** concentrates the sound and gives the effect of it coming from the centre of the television, **TruBass** enhances the lower bass frequencies.

- 1 Press **MENU** and select the **SOUND** menu.
- 2 Use **up** or **down** to highlight **WOW** then press **OK**.

 WOW, SRS and (●) symbol are trademarks of SRS Labs, Inc.
WOW technology is incorporated under license from SRS Labs, Inc.



- 3 Press **down** to highlight **SRS 3D** and using **left** or **right** select between **On** or **Off**.
- 4 Then press **down** to highlight **FOCUS** and press **left** or **right** to select between **On** or **Off**.
- 5 Highlight **TruBass** and use **left** or **right** to select **Off**, **Low** or **High** to suit your preference.

NOTE: This feature is not available through headphones.

Dual

If a programme or film is being broadcast with a soundtrack in more than one language, the **DUAL** feature allows selection between them.

- 1 Press **MENU** and select the **SOUND** menu.
- 2 Use **down** to highlight **Dual** then press **left** or **right** to choose between **Dual 1** or **Dual 2**.

Stable sound®

The **Stable Sound** feature limits high volume levels and prevents the extreme changes in volume that can occur when channels are changed or a programme switches to a commercial.

- 1 Press **MENU** and select the **SOUND** menu.
- 2 Use **down** to highlight **Stable Sound** then press **left** or **right** to select **On** or **Off**.

Widescreen viewing

Depending on the type of broadcast being transmitted, programmes can be viewed in a number of formats. Press the  button repeatedly to select between **Exact Scan**, **Wide**, **Super Live 2**, **Cinema 2**, **4:3**, **Super Live 1**, **Cinema 1**, **Subtitle** and **14:9**. Please note: Whenever the **MENU** button is pressed the picture size settings will change while the menus are ON the screen. This is to ensure the menus do not overlap the edges of the viewable area.

SUPER LIVE 1

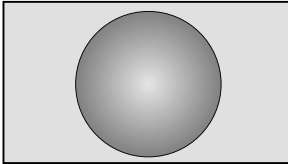

This setting will enlarge a 4:3 image to fit the screen by stretching the image horizontally and vertically, holding the correct proportions at the centre of the image. Some distortion may occur.

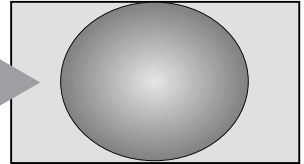

SUPER LIVE 2

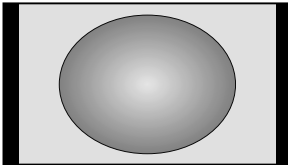

If a 'side panel format' signal is being received this setting will enlarge the image to fit the screen by stretching the image horizontally and vertically, holding the correct proportions at the centre of the image. Some distortion may occur.

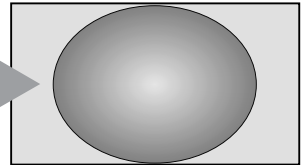

CINEMA 1

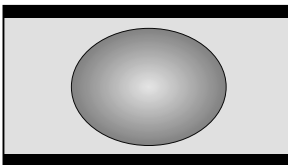

When watching 'letterbox format' films/video tapes, this setting will eliminate or reduce the black bars at the top and bottom of the screen by zooming in and selecting the image without distortion.

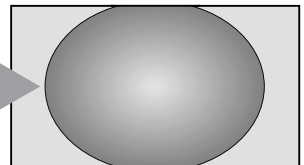

CINEMA 2

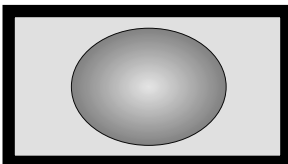

When watching 'all sides panel format' films/video tapes, this setting will eliminate or reduce the black bars at all sides of the screen by zooming in and selecting the image without distortion.

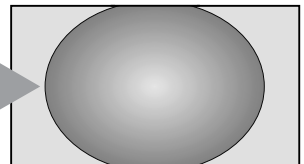

SUBTITLE

When subtitles are included on a letterbox format broadcast, this setting will raise the picture to ensure that all the text is displayed.

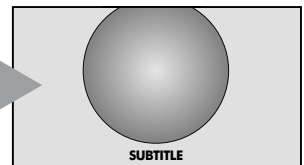

Widescreen viewing continued

14:9

Use this setting when watching a 14:9 broadcast.

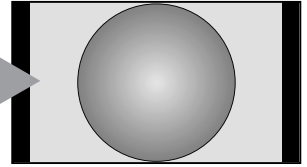

WIDE

Use this setting when watching a widescreen DVD, widescreen video tape or a 16:9 broadcast (when available). Due to the range of widescreen formats (16:9, 14:9, 20:9 etc.) black bars may be visible on the top and bottom of the screen.

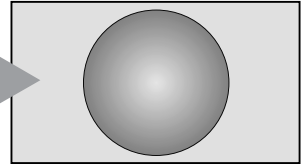

4:3

Use this setting to view a true 4:3 broadcast.

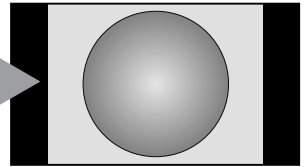



42 MODEL ONLY

 This option is only available when watching a 1080i source.

EXACT SCAN

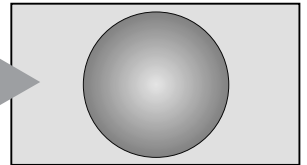
Use this setting when watching a 1080i source, it will display the image as transmitted without scaling or cropping the picture.



Press and hold the  button and a list of all the widescreen formats will appear on screen. Use **up** and **down** to highlight the required format and **OK** to select.

Exact Scan
Wide
Super Live 2
Cinema 2
4:3
Super Live 1
Cinema 1
Subtitle
14:9

Using the special functions to change the size of the displayed image (i.e. changing the height/width ratio) for the purposes of public display or commercial gain may infringe on copyright laws.

Picture controls

Picture position

The picture position may be adjusted to suit personal preference and can be particularly useful for external inputs.

- 1 In the **SET UP** menu press **down** until **Picture position** is highlighted.

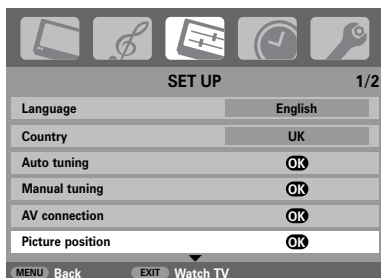

- 2 Press **OK** to view the options available for the picture format that has been selected.
- 3 Press **up** and **down** to select an option, then **left** or **right** to adjust the settings.

The options alter depending on the widescreen format chosen and when viewing connected equipment.

In **Cinema 2**:



To return to the original factory settings select **Reset** in the **Picture position** menu and press **OK**.

Back light

Adjusting the **Back light** can improve the clarity of the screen when viewing.

- 1 In the **PICTURE** menu press **down** to select **Picture settings**, then press **OK**.



- 2 In the **Picture settings** menu press **down** to select **Back light**.
- 3 Press **left** or **right** to adjust.

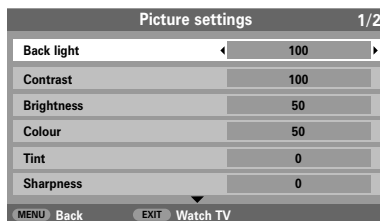

Picture controls continued

Picture preferences

This television offers the choice of personalising the picture style. Press →|← to view the different styles available:

Picture mode-1 to 3 are preset options and **Picture mode-M** stores your own settings:

- 1 Select **Picture settings** from the **PICTURE** menu.

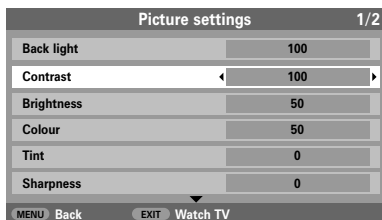

- 2 Use **left** or **right** to adjust the **Contrast**, **Brightness**, **Colour**, **Tint** and **Sharpness**.

Black stretch

Black Stretch increases the strength of dark areas of the picture which improves the definition.

- 1 In the **Picture settings** menu press **down** until **Black Stretch** is highlighted.

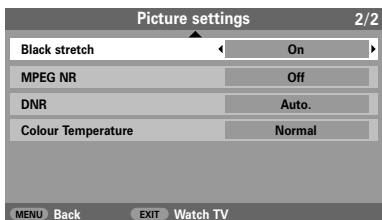

- 2 Press **left** or **right** to select between **On** and **Off**. The effect depends on the broadcast and is most noticeable on dark colours.

MPEG NR – Noise Reduction

When watching a DVD the compression may cause some words or picture elements to become distorted or pixelated. Using the **MPEG NR** feature reduces this effect by smoothing out the edges.

- 1 Select **MPEG NR** from the **Picture settings** menu. Use **left** or **right** to select a setting to suit your preference.

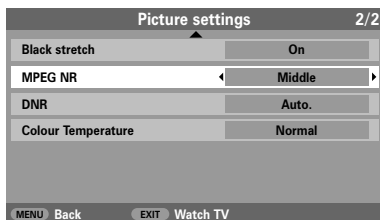

DNR – Digital Noise Reduction

DNR enables you to 'soften' the screen representation of a weak signal to reduce the noise effect.

- 1 Select **DNR** from the **Picture settings** menu. Use **left** or **right** to adjust. The differences may not always be noticeable (for the best result use lower settings as picture quality can be lost if the setting is too high).

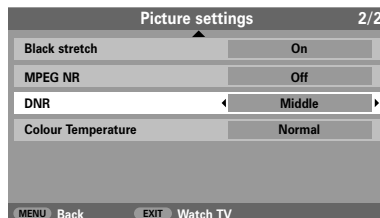

Picture controls continued

Colour temperature

Colour Temperature increases the 'warmth' or 'coolness' of a picture by increasing the red or blue tint.

- 1 In the **Picture settings** menu press **down** until **Colour Temperature** is highlighted.

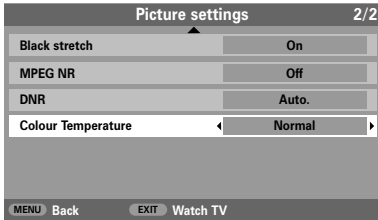

- 2 Press **left** or **right** to select between **Normal**, **Warm** and **Cool** to suit your preference.

3D Colour management

When **3D Colour management** is selected it allows the 'Base colour adjustment' feature to become available.

- 1 In the **PICTURE** menu press **down** to select **3D Colour management**.

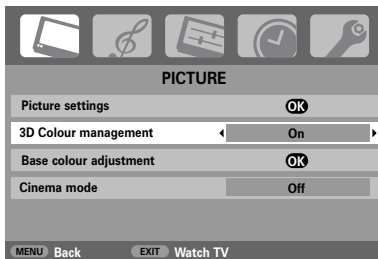

- 2 Press **left** or **right** to select **On** or **Off**.

Base colour adjustment

The **Base colour adjustment** feature allows the adjustment of individual colours to suit personal preference. This can be useful when using an external source.

- 1 In the **PICTURE** menu press **down** to select **Base colour adjustment**, then press **OK**.

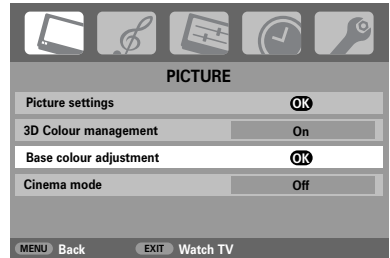

- 2 Press **up** and **down** to select an option, then **right** to adjust the settings.

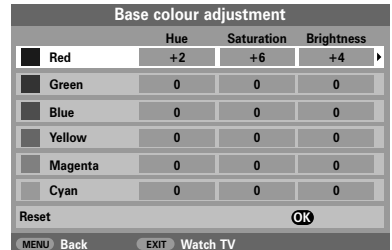

To return to the original factory settings select **Reset** and press **OK**.

Picture controls continued

Cinema mode

If there are lines or jagged edges in the film or programme being viewed, selecting **Cinema mode** can help correct this by smoothing out the picture.

- 1 In the **PICTURE** menu press **down** to select **Cinema mode**.



- 2 Press **left** or **right** to select **On** or **Off**.

Automatic format (Widescreen)

When this television receives a true Widescreen picture and **Auto format** is **On**, it will automatically be displayed in Widescreen format, irrespective of the television's previous setting.

- 1 Press **MENU** and **left** or **right** to select the **FUNCTION** menu.

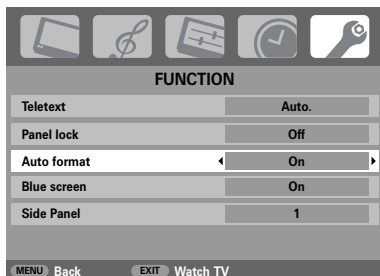

- 2 Press **down** to highlight **Auto format**, then **left** or **right** to select **On** or **Off**.

Blue screen

When **Blue screen** is selected the screen will turn blue and the sound will be muted when no signal is received.

- 1 In the **FUNCTION** menu press **down** to highlight **Blue screen**.

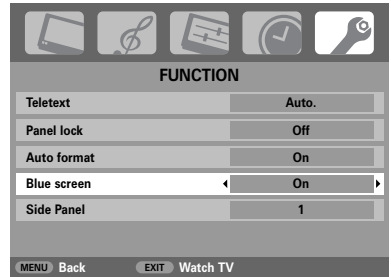

- 2 Press **left** or **right** to select **On** or **Off**.

Side panel adjustment

The **Side Panel** feature lightens or darkens the band each side of the screen when in 4:3 or 14:9 format. This helps prevent image retention of the band and can also make viewing in bright or dark conditions more comfortable.

- 1 In the **FUNCTION** menu press **down** until **Side Panel** is highlighted.

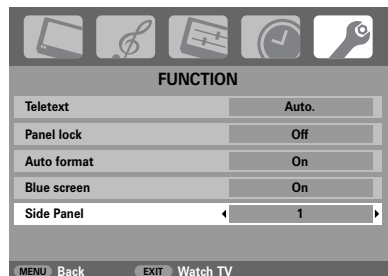

- 2 Press **left** or **right** to adjust.

Panel lock, time display, stereo/bilingual transmissions, the timer

Panel lock

Panel lock disables the buttons on the television. All buttons on the remote control can still be used.

- 1 From the **FUNCTION** menu select **Panel lock** and choose **On** or **Off** using **left** or **right**.

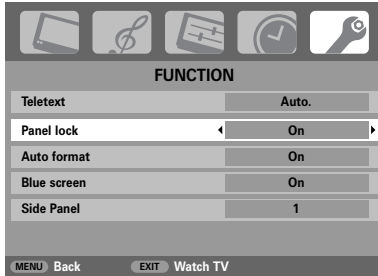

When **Panel lock** is **On**, a reminder will appear when the buttons on the television are pressed. **If the standby button is pressed the television will switch off and can only be brought out of standby by using the remote control.**

The Time Display

The time display facility allows the current (text service) time to be seen on the television screen.

Press **⏻/⏮** whilst watching a normal television broadcast to see a time display from the broadcaster. It will remain on screen for about 5 seconds.

Stereo and Bilingual transmissions

If stereo or dual language broadcasts are transmitted the word Stereo or Dual will appear on the screen each time programme positions are changed, disappearing after a few seconds. If the broadcast is not in stereo the word Mono will appear.

Stereo... Press **⏻/⏮** to select **Stereo** or **Mono**.

Bilingual... Bilingual transmissions are rare. If they are transmitted the word **Dual** will display. Choose the required programme number and if the word **Dual** appears press **⏻/⏮** to select **Dual 1**, **Dual 2** or **Mono**.

The Timer

*The television can be set to turn itself **On** or **Off** after a certain time.*

- 1 Press **MENU** and **left** or **right** to select the **TIMER** menu.



- 2 Press **down** to select **On** or **Sleep timer**. Use the number buttons to set the required time. For example, to switch the television off in one and a half hours enter 01:30, or press **right** to increase/decrease in steps of 10 minutes.
- 3 If setting the **Sleep timer**, press **EXIT** to finish. If setting the **On timer**, press **down** to select **On timer Position**, enter the programme position number required, then press **⏻** to put the television into Standby. The **GREEN** On timer indicator on the front of the television will now be lit.

Any equipment connected with SCART leads must also be put into Standby to prevent them from being displayed when the timer switches on.

Once the **On timer** has been set the television can be switched on at any time by pressing **⏻**. The Green On timer indicator will remain on until the set time period as passed when the television will go to the chosen channel. This feature can help to avoid missing favourite programmes.

- 4 To cancel the **On timer/Sleep timer**, enter zero in each position.

PC settings – picture position, clock phase, sampling clock, reset

Picture position

The picture position may be adjusted to suit personal preference.

- 1 Press **⏪** to select **PC**, then select **PC Setting** from the **SET UP** menu.

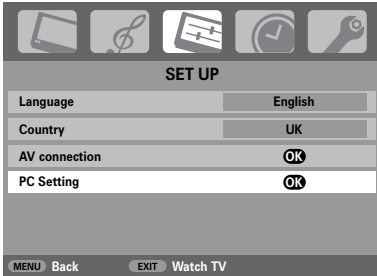

- 2 Press **OK**. Press **up** and **down** to select an option, then **left** or **right** to adjust the settings.

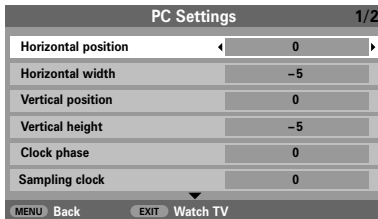

Clock phase

The **Clock phase** matches the PC signal with the LCD display. Adjusting this can clear horizontal stripes and picture blur.

- 1 In the **SET UP** menu press **down** until **PC Setting** is highlighted.
- 2 Press **OK** to select, then **down** to highlight **Clock phase**.
- 3 Use **left** or **right** to adjust until the picture clears.

Sampling clock

Adjusting the **Sampling clock** alters the number of pulses per scan, this will clear vertical lines on the screen.

- 1 In the **SET UP** menu press **down** until **PC Setting** is highlighted.
- 2 Press **OK** to select, then **down** to highlight **Sampling clock**.

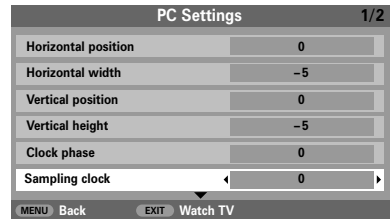

- 3 Use **left** or **right** to adjust until the picture clears.

Reset

To return to the original factory settings.

- 1 In the **SET UP** menu press **down** until **PC Setting** is highlighted.
- 2 Press **OK** to select, then **down** to highlight **Reset**.

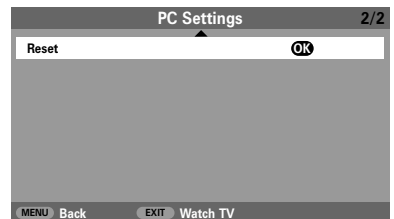

- 3 Press **OK**.

Input selection and AV connections

Defining the INPUT and OUTPUT sockets so that the television recognises connected equipment. See page 6 for a clear view of the back connection recommendations.

Most media recorders and decoders send a signal through the SCART lead to switch the television to the correct *Input* socket.





Alternatively press the external source selection button  until the picture from connected equipment is shown.

This button must be used to view equipment connected using the COMPONENT VIDEO INPUT (EXT3C).

An **S** in the display e.g.  2S (EXT 2S), indicates the input is set for an S-Video signal.

Input selection

Use the *Input Selection* if the television does not switch over automatically.

- 1 Press  to select , ,  (EXT1-3), **HDMI1**, **HDMI2** or **PC**.

HDMI™ displays equipment connected to *Input HDMI* on the back of the television. It is designed for best performance with 1080i high definition signals.

PC displays a computer connected to *Input RGB/PC* on the back of the television.

- 2 To return to television mode press  again or one of the numbered buttons.

INPUT signal selection

This specifies the type of signal going into SCART 2 (EXT2) on the back of the television. Please refer to the manufacturers instructions for the connected equipment.

- 1 In the **SET UP** menu press **down** until **AV connection** is highlighted, then press **OK**.



- 2 With **left** or **right** select either **AV** or **S-VIDEO** as the required *input* for **EXT2**.

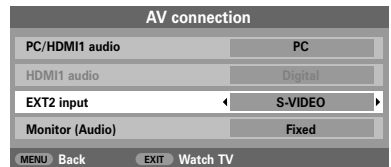

If the colour is missing try the alternative setting.

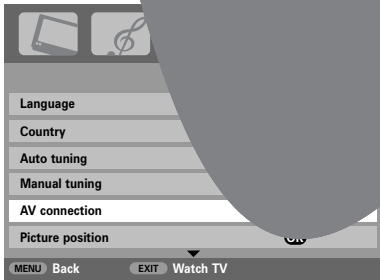

Text services – setting up, general information, Auto and LIST modes

This television has a multi-page text memory, which takes a few moments to load. It offers two *Modes* of viewing text – **Auto** will display **Fastext**, if available. **LIST** will store your four favourite pages.

Selecting modes



The text character set will be automatically chosen by the language setting in the **SET UP** menu.

- 1 Select **Teletext** from the **FUNCTION** menu.
- 2 With **left** or **right** choose **Auto.** or **LIST** then press **EXIT**.



Text information

The    button:

To view text services press   . Press again to superimpose the text over a normal broadcast picture and again to return to normal viewing. Programmes cannot be changed until text is cancelled.

The first text page shown will be the *initial* page.

Any text page can be accessed by entering the 3 digit page number using the numbered buttons, pressing the coloured buttons or pressing **P ▲** to advance to the next page and **P ▼** to go back to the previous page.

Sub-pages

If there are sub-pages they will automatically load into memory without changing the page on screen.

To access the sub-pages press  then use **P ▲** and **P ▼** to view them. A bar with numbers will appear on the side of the screen.

The sub-page you are viewing will be highlighted and, as the television loads any additional sub-pages the colour of the numbers will change, indicating that these pages have been loaded.

These sub-pages will remain available to view until another page is chosen or, in normal TV mode, the channel is changed.

Navigating pages using Auto.

If **Fastext** is available four coloured titles will appear at the base of the screen.

To access one of the four given subjects, press the relevant coloured button on the remote control.

For further information on your particular text system(s), see the broadcast text index page or, consult your local Toshiba dealer.

Navigating pages using LIST

The four coloured choices at the bottom of the screen are numbers – 100, 200, 300 and 400, which have been programmed into the television's memory. To view these pages press the relevant coloured buttons.

To *change* these stored pages press the relevant coloured button and enter the 3 digit number. This number will change in the top left of the screen and in the coloured highlight.

Press **OK** to store. The bars at the bottom of the screen will flash white. **Whenever OK is pressed all four page numbers showing at the bottom will be stored and the previous ones will be lost.**

If **OK** is not pressed the selection will be forgotten when text is cancelled.

Other pages may be viewed by entering the 3 digit page number – but **DO NOT** press **OK** or these pages will be stored.

Text services continued



– control buttons

Below is a guide to the functions of the remote control text buttons.

 To display the index/initial page:

Press  to access the index/initial page. The one displayed is dependant on the broadcaster.

/ /  To display a page of text:

Press / /  to display text. Press again to superimpose text over a normal broadcast picture. Press again to return to normal television viewing. Programmes cannot be changed until this has been done.



 To access sub-pages:

For use with **P ▲** and **P ▼** to view sub-pages when available.

 To reveal concealed text:

To discover the solutions on quiz and joke pages press the  button.





 To hold a wanted page:

At times it is convenient to hold a page of text. Press  and  will appear in the top left of the screen. The page will be held on screen until the button is pressed again.





 To enlarge the text display size:

Press  once to enlarge the top half of the page, press again to enlarge the bottom half of the page. Press again to revert to normal size.





/  To select a page whilst viewing a normal picture:

Enter the page number then press / , a normal picture will be displayed. The television will indicate when the page is present by displaying the page number at the top of the screen. Press / /  to view the page.

To display news flashes:

Select the news flash page for the chosen text service (see the index page of text service). Press / . The news flashes will be displayed as and when they are broadcast. Press /  again to cancel the display.

The news flash page must be cancelled before changing programmes.

 Remember to cancel text before changing channels – press the / /  button twice.

For television operation queries, please ring the helpline...

Below are the answers to some of the most common queries.
For more information go to www.toshiba.co.uk

Q Why is there no sound or picture?

A Check the mains switch is on and check all mains connections.
Check the television is not in standby mode.

Q There is a picture, but why is there little or no colour?

A When using an **external** source, for instance, a poor quality video tape, if there is little or no colour, improvements may sometimes be achieved. The colour is factory set to **Auto**, to automatically display the best colour system.

To check that you have the best colour:

1 With the external source playing, select **Manual setting** from the **SET UP** menu.

2 With **up** or **down** choose between **Auto.**, **PAL**, **SECAM**, **NTSC 4. 43** or **3. 58**.

Q Why doesn't the video/DVD being played show on screen?

A Make sure the VCR or DVD player is connected to the television as shown on page 6, then select the correct input by pressing **↻**.

Q Why is there a good video picture but no sound?

A Check all lead connections.

Q Why is there a picture but no sound?

A Check the volume has not been turned down or that sound mute has not been selected.

Q Why is the VCR/DVD picture in black and white?

A Check the correct **input** has been chosen, **S-VIDEO** or **AV**. See **AV connections** page.

Q Why don't the controls on the front of the television work?

A Check that **Panel lock** is not **ON**.

Q Why is there a message permanently on the screen?

A Remove it by pressing **i+**.

Questions and Answers continued

Why are there horizontal stripes and/or blurred

A The **Clock phase** may need adjustment. Select **PC Setting** from the **SET UP** menu, highlight **Clock phase** and adjust until the picture clears.



Q *Why are there problems with text?*

A Good performance of text depends on a good strong broadcast signal. This normally requires a roof or loft aerial. If the text is unreadable or garbled, check the aerial. Go to the *main index* page of the text service and look for the *User Guide*. This will explain the basic operation of text in some detail. If further information is needed on how to use text see the *text section*.

Q *Why are there no text sub-pages?*

A There are none broadcast or they have not yet loaded. Press the  button to access. (See *text section*).

Q *Why are the four coloured text numbers visible but no text?*

A Text has been selected whilst viewing an external source i.e. DVD or VCR. No text will appear on screen or a box may appear stating no information is available. Select a broadcasting channel and press  /  to access.

Q *Why are the colours wrong when an NTSC source is played?*

A Connect the source via a SCART lead and play. Select **Manual setting** from the **SET UP** menu.

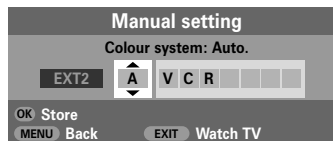

- 1 Set the Colour to **Auto.** and exit.
- 2 Go to the **Picture settings** menu and adjust the tint.

Cleaning the screen and cabinet...

Turn off the power, clean the screen and cabinet with a soft, dry cloth. We recommend that you **do not** use any proprietary polishes or solvents on the screen or cabinet as this may cause damage.

Disposal...

The following information is only for EU-member states:

The use of the symbol indicates that this product may not be treated as household waste. By ensuring this product is disposed of correctly, you will help prevent potential negative consequences for the environment and human health, which could otherwise be caused by inappropriate waste handling of this product. For more detailed information about recycling of this product, please contact your local city office, your household waste disposal service or the shop where you purchased the product.



Specifications and accessories

Broadcast systems/channels

PAL-I	UHF UK21-UK69
PAL-B/G	UHF E21-E69 VHF E2-E12, S1-S41
SECAM-L	UHF F21-F69 VHF F1-F10, B-Q
SECAM-D/K	UHF R21-R69 VHF R1-R12

Video Input PAL, SECAM, NTSC 3.58/4.43

External connections

EXT1	Input	21-pin SCART	RGB, A/V
EXT2	Input	21-pin SCART	A/V, S-video
EXT3	Input	Phono jacks Phono jacks	Y, P _B /C _B , P _R /C _R A/V
EXT3	Input (Side)	Phono jack Phono jacks	Video Audio L + R
HDMI 1/2	Input	HDMI connector	
PC	Input	Mini D-sub 15-pin	Analog RGB signal
PC/HDMI1 Audio		Phono jacks	Audio L + R
Audio Output Fixed/Variable		Phono jacks	Audio L + R

Stereo

Nicam
2 carrier system

Visible Screen Size (approx.)

Model 26	66cm
32	80cm
37	94cm
42	107cm

Display

16:9

Sound output (at 10% distortion)

Main 10W + 10W

Power consumption as specified in EN60107-1 : 1997

Model 26	129W
32	153W
37	161W
42	245W

Standby (approx.)

Model 26	<1W
32	<1W
37	<1W
42	<1W

Dimensions (approx.)

Model 26	54cm (H)	66cm (W)	28cm (D)
32	61cm (H)	80cm (W)	30cm (D)
37	69cm (H)	92cm (W)	30cm (D)
42	78cm (H)	105cm (W)	36cm (D)

(Height dimension includes foot stand)

Weight (approx.)

Model 26	15kg
32	19kg
37	25kg
42	33kg

Headphone socket

3.5mm stereo

Accessories

Remote control
2 batteries
(AAA, IEC R03 1.5V)



Printed on recycled paper. 100% Chlorine free.

© Toshiba Information Systems (U.K.) Limited

All rights reserved.

Reproduction in whole or part without written permission is strictly prohibited.

Toshiba Information Systems (U.K.) Limited

Consumer Products Division,
European Service Centre,
Admiralty Way, Camberley,
Surrey, GU15 3DT, UK

Specification is subject to change without notice.

Originated by Kensa Creative Solutions, Saltash, Cornwall.

**26/32/37/42WL/
EL/DL66/67
VX1A000012A0**