

TOSHIBA

Leading Innovation >>>

OWNER'S MANUAL

Integrated Digital LCD TV



HDMI

37X3000A

42X3000A

46X3000A

52X3000A

Owner's Record

You will find the model number and serial number on the back of the TV. Record these numbers in the spaces provided below. Refer to them whenever you call upon your TOSHIBA dealer regarding this product.

Model number:

Serial number:

DVB registration identification reference number: 4730 (37X3000A), 4731 (42X3000A), 4941 (46X3000A), 4732 (52X3000A).

Trademark of the DVB – Digital Video Broadcasting Project

©TOSHIBA CORPORATION, 2007

All Rights Reserved

VX1A000575A0

Contents

Introduction

Welcome to Toshiba	3
Important Safety Instructions	3
Installation	3
Use	4
Service	5
Cleaning	6
Important information	6

Getting started

Connecting an antenna	7
Exploring your new TV	7
Installing the remote control batteries	7
TV front and side panel controls	8
TV back panel connections	9
Learning about the remote control	10
Location of controls	10
Turning the TV on	11
Switching on the TV	11
Switching off the TV	11
Tuning the TV for the first time	11
- digital only -	11
Learning about the menu system	12
Displaying the DIGITAL SETTING chart	12
Displaying the TV SETUP menu chart	12
Programming channels into the TV's channel memory	13
Auto scan - digital only -	13
Manual scan - digital only -	14
Programming channels automatically	14
- analog only -	14
Manually setting channels in the channel memory - analog only -	15
Watching TV programs	16
Viewing Digital programs - digital only -	16
Selecting channel from Navigation List	16
- digital only -	16
Changing the program position - analog only -	16
Switching between two program positions	16
Selecting the menu language - analog only -	16
Displaying the on-screen information	16
- analog only -	16
On-screen information - digital only -	16
Setting the I-Plate Display Time - digital only -	17
Setting the Time Format	17
Sorting program position - analog only -	17

Using the TV's features (General)

Picture adjustment	18
Selecting the picture size	18
Using the picture still	19
Adjusting the picture position - analog only -	19
Resetting the picture position - analog only -	19
Selecting the picture mode	19
Adjusting the basic picture quality	20
Activating the black stretch	20
Activating the MPEG NR (Noise Reduction)	20
Activating the DNR (Digital Noise Reduction)	20
- analog only -	20
Selecting the color temperature	20
Adjusting the color management	20
Resetting the base color adjustment	21
Using the active backlight control	21
Using the cinema mode - analog only -	21
Using the auto format	21
Activating the ANT ATT (Antenna Attenuation)	21
Sound adjustment	22
Setting the MTS (Multi-channel TV Sound)	22
- analog only -	22
Selecting the dual 1 or dual 2 mode	22
- analog only -	22
Selecting the stereo programs - analog only -	22
Selecting the bilingual programs - analog only -	22
Adjusting the sound quality	22
Using the SRS WOW® surround sound	23
Using the stable sound	23
Using the bass boost	23

Activating blue screen	23
Adjusting the brightness of side panel	23
The timers	24
Setting the Time zone - digital only -	24
Program Timer - digital only -	24
Setting the Alarm - digital only -	25
Setting the sleep timer	25
Selecting the video input source to view	25
Setting the manual setting menu - analog only -	26
Teletext in Analog TV	26
Setting up the teletext mode	26
Teletext general information	26
Using Auto mode	27
Using LIST mode	27
Teletext buttons on the remote control	28
Teletext in Digital TV	28

Other Digital TV features and settings

Setting the EPG (Electronic Program guide)	29
Password	29
Setting the Password	29
Select the Password Status	29
Parental rate	30
Setting the parental rate	30
Channel list	30
Setting favorite, locking and skipping channels	30
Editing channel names	30
Favorite Channel List	31
Favorite Mode	31
Subtitle	31
Restore factory setting	31
Audio Preference	32
Selecting The Audio Mode	32
Digital Output Format	32
MPEG Audio Level	32
Audio Track	32
Transparency	32
TV Setup	32

Connecting your TV

Back connections	33
Connection example	33
Connecting an audio system - digital only -	33
Connecting an amplifier equipped with a Dolby Digital decoder	34
Connecting an amplifier equipped with an MPEG decoder	34
Connecting an amplifier equipped with a digital audio (optical or coaxial) input	34
Side connections	35
Connection example	35
Connecting an HDMI or a DVI device	35
Connecting an HDMI or a DVI device	35
Connecting an HDMI device	36
Connecting a DVI device	36
Selecting the PC/HDMI1 audio mode	36
Setting the HDMI1 audio mode	36
Selecting the AV output mode	37
Connecting a computer	37
Using the PC setting	38
Adjusting the picture size/position	38
Adjusting the clock phase of the picture	38
Adjusting the sampling clock	38
Resetting the PC setting	38

Reference section

Troubleshooting	39
Symptom and solution	39
Symptom and solution - digital only -	39
APPENDIX	40
AUSTRALIAN PARENTAL GUIDANCE	40
CODES (Normative)	40
Broadcast system	41
Broadcast transmission systems of each country or region	41
Specifications	41
Integrated Digital LCD TV	41

Introduction

Welcome to Toshiba

- Thank you for purchasing this Toshiba LCD Color Television. This manual will help you use the exciting features of your new TV.
- Instructions in this manual are based on using the remote control.
- Please read all safety and operating instructions in this manual carefully, and keep this manual for future reference.

Important Safety Instructions

Be sure to observe the following instructions and precautions to ensure safe use of this TV.

Installation

- 1) **Always connect the power plug to an appropriate electrical outlet equipped with 220-240V, AC 50Hz.**
Never use the TV outside the specified voltage range. It may cause a fire or an electric shock.

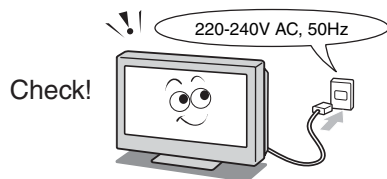

- 2) **Never insert or remove the power plug with wet hands.**
This may cause an electric shock.

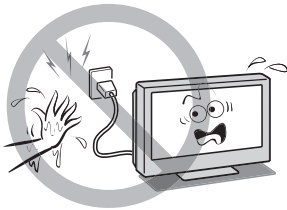

- 3) **Never place the TV in an unstabilized location such as on a shaky table, incline or location subject to vibration.**
The TV may drop or fall off which may cause injury or damage.

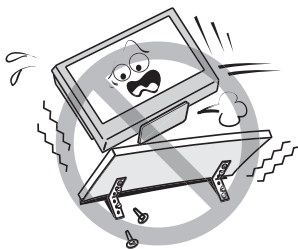

- 4) **Never block or cover the slots and openings in the cabinet.**
 - Never place the TV so that it is facing upward or on its side.
 - Never place the TV in a closet, bookcase or other similar area where the ventilation is poor.
 - Never drape a newspaper, tablecloth or curtain on the TV.
 - When installing the TV against a wall, always keep the TV at least 10 cm away from the wall.
 - Never place the TV on a soft unstable surface, such as a carpet, or a cushion.

The inside of this TV will overheat if the ventilation holes are covered, blocked or sealed, which may result in a fire.

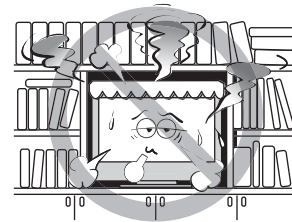

- 5) **Never place the TV near a heater or in direct sunlight.**

The surface of the cabinet or power cord may melt and result in a fire or an electric shock.

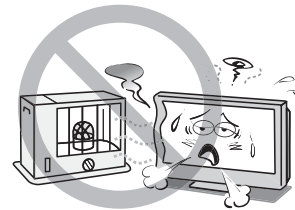

- 6) **Never place the TV in an area exposed to high humidity levels, such as in a bathroom or close to a humidifier.**
This may cause a fire or an electric shock.

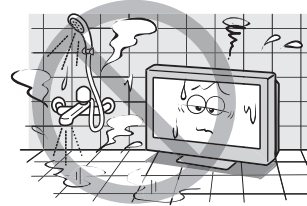

- 7) **Never place the TV next to a stove where it will be exposed to oil, smoke, or steam, or in a location where there is a large quantity of dust.**
This may cause a fire or an electric shock.

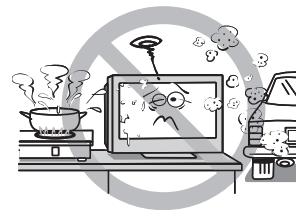

8) Install the TV in a horizontal, stable location. Connect between two clips on the back of the TV and a wall, pillar, etc., with a sturdy tie and clip of supplied accessories (see page 42).

- Use as short a tie as possible to ensure the TV is stable.
- If the TV is not installed securely, it may lean or fall over and cause an injury.
- To prevent injury, use the exclusive optional stand or wall-hanging bracket to install this TV on the floor or wall securely in accordance with a qualified technician.

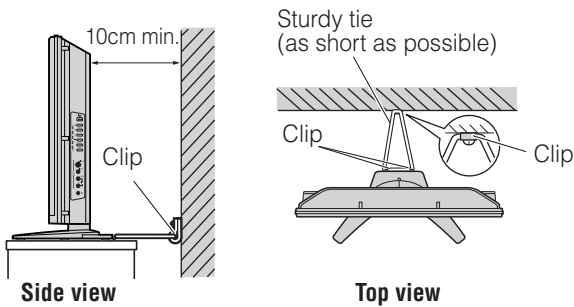

9) Precautions for moving the TV

- When moving the TV, be sure to remove the plug from the wall outlet and disconnect the antenna cable and audio/video cables, any steady ties. Fire or electric shock may result if the power cord is damaged.
- When carrying the TV, at least two people are needed. Be sure to carry it upright.
- Never carry the TV with the screen facing up or down.

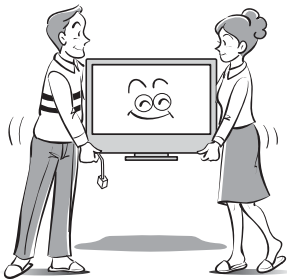

10) Precautions for installing on outdoor antenna

An outside antenna system should not be located in the vicinity of overhead power lines, or other electric light or power circuits. If the antenna falls down or drops, it may cause injury or electric shock.



Use

1) Never place hot objects or open flame sources, such as lighted candles or nightlights, on or close to the TV.

High temperatures can melt plastic and lead to fires.

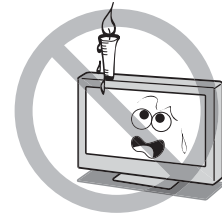

2) The apparatus shall not be exposed to dripping or splashing and that no objects filled with liquids, such as vases, shall be placed on the apparatus.

When liquids are spilled or small items are dropped inside the TV, this may cause a fire or an electric shock. If small objects drop inside the TV, turn off the TV and remove the power plug from the outlet immediately and contact a service technician.



3) Never insert objects (metal or paper) or pour water inside the TV through ventilation holes and other openings.

These items may cause a fire or an electric shock. If these objects are inserted inside the TV, turn off the TV and remove the power plug from the outlet immediately and contact a service technician. Be especially careful that children do not insert objects in the TV.



4) Never stand or climb on the TV.

Be especially careful in households with children to prevent them through climbing on top of the TV. It may move, fall over, break, become damaged or cause an injury.



5) **When the TV will not be used for a long period of time, such as during vacation or travel, remove the power plug from the wall outlet for safety.**

- The TV is not completely disconnected from the power supply line, as minute current is consumed even when the O/I Power switch is turned off.
- The Mains plug or an appliance coupler is used as the disconnect device, therefore the disconnect device shall remain readily operable.



6) **Never pull on the power cord when removing the plug from the wall outlet.**

Always hold the plug firmly when removing it. If the power cord is yanked, the cord may become damaged and a fire or an electric shock may occur.

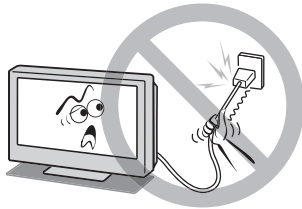

7) **Never cut, break, modify, twist, bunch up or bent the cord or apply excessive force or tension to it.**

Never place heavy objects on the cord or allow it to overheat as this may cause damage, a fire or an electric shock. Contact a service technician if the power cord is damaged.

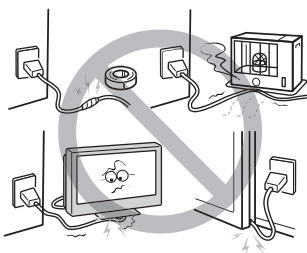

8) **If there is thunder or lightning, never touch the antenna cable or other connected cables.**

You may suffer an electric shock.

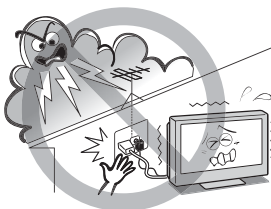

Service

1) **Never repair, modify or disassemble the TV by yourself.**

It may cause a fire or an electric shock. Consult a service technician for inspection and repairs.



2) **When a malfunction occurs, or if smoke or an unusual odor comes from the TV, turn off the TV and remove the power plug from the outlet immediately.**

Make sure that the smoke or smell has stopped, then contact a service technician. If the TV is still used in this condition, it may cause a fire or an electric shock.

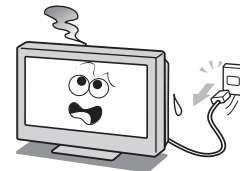

3) **If the TV is dropped or the cabinet is broken, turn off the TV and remove the power plug from the outlet immediately.**

If the TV is still power used in this condition, it may cause a fire or an electric shock. If the cabinet is broken, be careful when handling the TV to prevent an injury. Contact a service technician for inspection and repair.

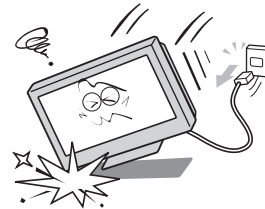

4) **When the TV reaches the end of its useful life, ask a qualified service technician to properly dispose of the TV.**

Note:

The lamp unit contains a small amount of mercury. Disposal of mercury may be regulated due to environmental considerations. Dispose of the used lamp unit by the approved method for your area. For disposal or recycling information, please contact your local authorities.

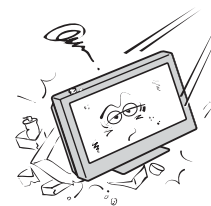

Cleaning

1) Remove the power plug before cleaning.

Never use solvents such as benzine or thinner to clean the TV.

- These solvents may distort the cabinet or damage its finish.
- If rubber or vinyl products remain in contact with the TV for a long time, a stain may result.

If the cabinet becomes dirty, clean it with a soft, dry cloth.

When cleaning the surface of the LCD display, wipe the panel surface gently with a soft, dry cloth.

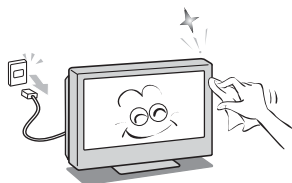

2) Periodically disconnect the power plug from the outlet and check it.

If dust has collected on the power plug connectors, clean off the dust with dry cloth.

This dust may cause a fire due to reduced insulation on the plug.



Important information

1) About LCD screen

- If you have the LCD screen facing to the sun, the LCD screen will be damaged. Be aware of locating the TV in the place such as window side or outside of the room.
- Never press the LCD screen strongly or scratch it, and never put anything on it. These actions will damage the LCD screen.

2) About cabinet and LCD screen

Never spray volatile compounds such as insecticide on the cabinet and LCD screen.

This may cause a discoloration or damage the cabinet and LCD screen.

3) Some pixels of the screen do not light up

The LCD display panel is manufactured using an extremely high level of precision technology, however sometimes some pixels of the screen may be missing picture elements or have luminous spots. This is not a sign of a malfunction.

4) About Interference

The LCD display may cause interference in image, sound, etc. of other electronic equipment that receives electromagnetic waves (e.g. AM radios and video equipment).

5) About using under the low temperature places

If you use the TV in the room of 0°C or less, the picture brightness may vary until the LCD monitor warms up. This is not a sign of a malfunction.

6) About afterimage

If a still picture is displayed, an afterimage may remain on the screen, however it will disappear. This is not a sign of malfunction.

Exemptions

- Toshiba is not liable for any damage caused by fires, natural disaster (such as thunder, earthquake, etc.), acts by third parties, accidents, owner's misuse, or uses in other improper conditions.
- Toshiba is not liable for incidental damages (such as profit loss or interruption in business, modification or erasure of record data, etc.) caused by use or inability to use of product.
- Toshiba is not liable for any damage caused by neglect of the instructions described in the owner's manual.
- Toshiba is not liable for any damage caused by misuse or malfunction through simultaneous use of this product and the connected equipment.

Connecting an antenna

Optimum reception of color requires a good signal and will generally mean that an outdoor antenna must be used. The exact type and positioning of the antenna will depend upon your particular area. Your Toshiba dealer or service personnel can best advise you on which antenna to use in your area. Before connecting the antenna cable, turn off all main power switches.

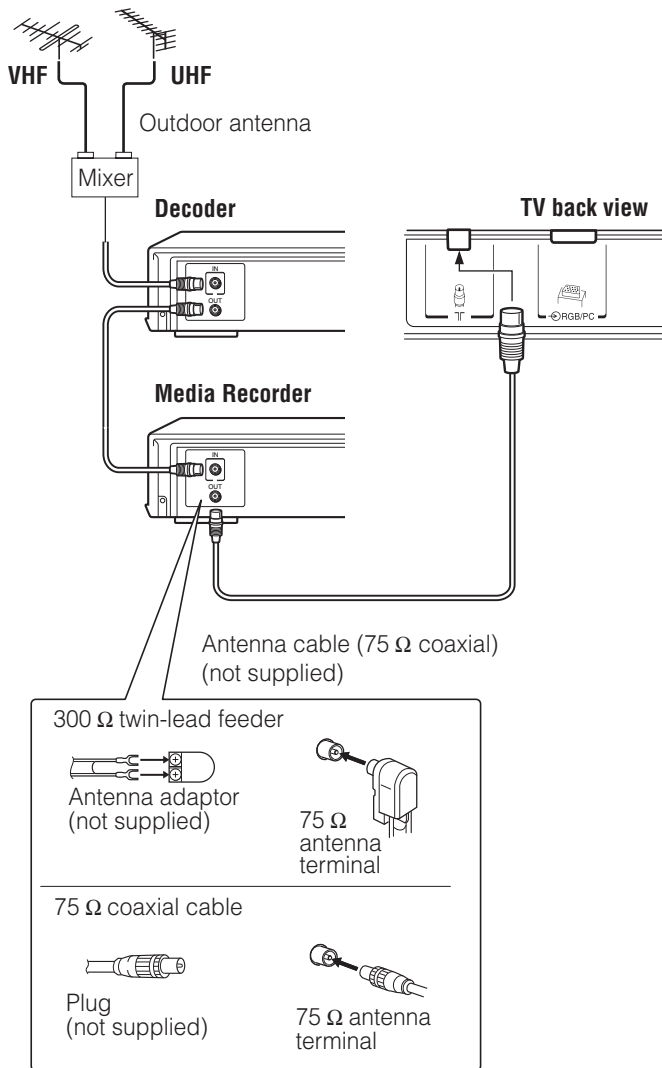

Exploring your new TV

Installing the remote control batteries

Remove the battery cover. Insert two R03 (AAA) batteries matching the $-/+$ polarities of the battery to the $-/+$ marks inside the battery compartment.

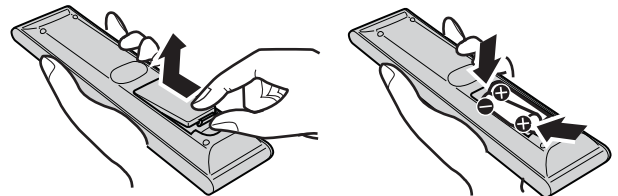

Cautions:

- Dispose of batteries in a designated disposal area. Never throw batteries into a fire.
- Attention should be drawn to the environmental aspects of battery disposal.
- Never mix battery types or combine used batteries with new ones.

Notes:

- If the remote control does not operate correctly, or if the operating range becomes reduced, replace both batteries with new ones.
- If the batteries are dead or if you will not use the remote control for a long time, remove the batteries to prevent battery acid from leaking into the battery compartment.

Effective range

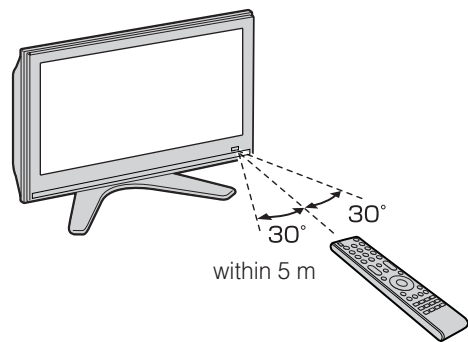

TV front and side panel controls

- You can operate your TV using the buttons on the side panel or the remote control. The back and side of the panel provide the terminal connections to connect other equipment to your TV (see “Connecting your TV” pages 33 - 37).
- For the use of each control, see the pages in brackets.

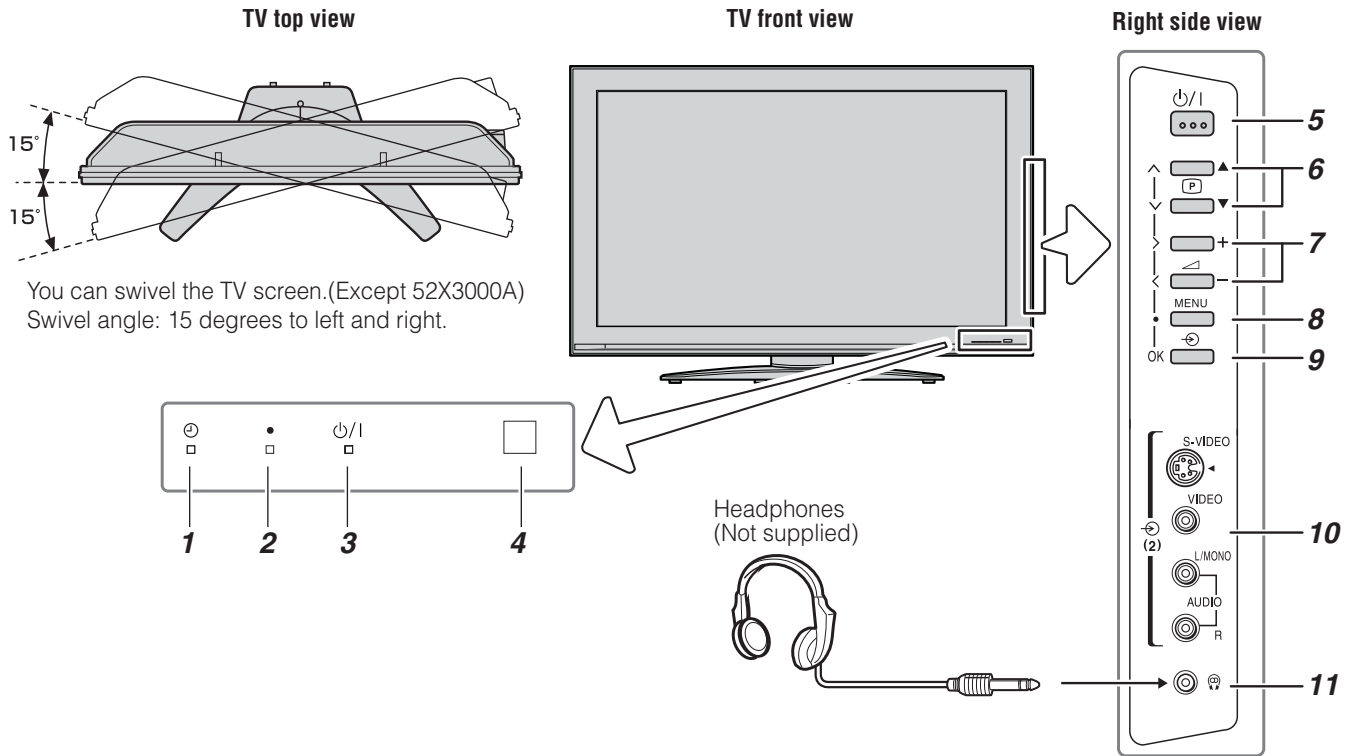

- 1** ☉ (**Alarm Timer LED**) — Timer indicator (see page 25).
- 2** ● (**DTV timer LED**) — Digital TV timer Recording Indicator (see page 24).
- 3** ⏻ (**Power LED**) — Power indicator (see page 11).
- 4** □ (**Remote sensor**) — Point the remote control toward this remote sensor (see page 7).
- 5** ⏻ (**Power on/Standby**) — Press to turn the TV on/standby (see page 11).
- 6** ⏪▲▼ (**Program position**) — When no menu is on-screen, these buttons select the program position. (see page 15).
 ▲▼ (**MENU up/down**) — When a Analog TV menu is on-screen, these buttons function as up/down menu navigation buttons (see page 12).
- 7** ⏴+ (**Volume**) — When no menu is on-screen, these buttons adjust the volume level (see page 10).
 ⏴< >⏵ (**MENU left/right**) — When a Analog TV menu is on-screen, these buttons function as left/right menu navigation buttons or adjust settings (see page 12).
- 8** MENU — Press to access the TV SETUP menu (see page 12).
- 9** ⏮ (**Input source selection**) — When no menu is on-screen, this button selects the input source (see page 25).
 OK — When a Analog TV menu is on-screen, this button functions as the next menu navigation button (see page 12, 25).
- 10** ⏮ (2) (**Video 2 input terminals**) — Optional S-video or standard video and standard audio inputs (see page 35).
- 11** 🎧 (**Headphone jack**) — For use with headphones.

Note:

When the Headphone jack is being used, the sound from all speakers will be muted, and normal sound will be output to the headphones only.

TV back panel connections

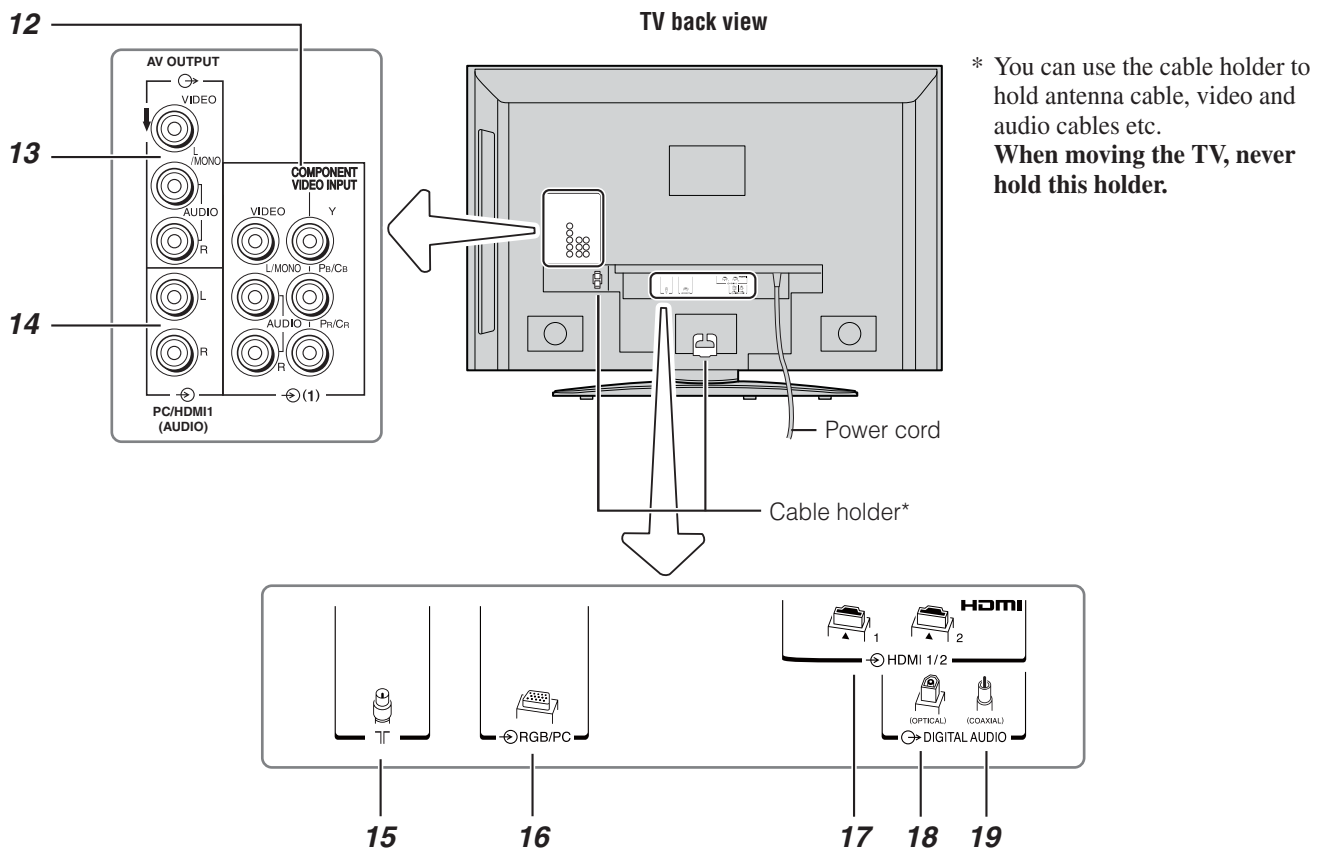

12 ⊕ (1) **(Video 1 input terminals)** — High-definition component video or standard (composite) video and standard (analog) stereo audio inputs (🔗 page 33).

13 ➡ **AV OUTPUT (output terminals)** — For use when connecting a VCR/HDD/DVD video recorder with standard video and standard audio inputs (🔗 page 33). No On-Screen-Display will output from this terminals.

14 ⊕ **PC/HDMI1 (AUDIO) (input terminals)** — PC audio input terminals are shared with HDMI-1 analog audio input terminals, and their use can be configured in the **SET UP** menu. (🔗 page 33, 36).

15 ⏏ **(Antenna input terminal)** — Analog antenna signal input (🔗 page 7).

16 ⊕ **RGB/PC (input terminal)** — For use when connecting a personal computer (PC) (🔗 page 37).

17 ⊕ **HDMI1 and HDMI2 (input terminals)** — High-Definition Multimedia Interface input receives digital audio and uncompressed digital video from an HDMI device or uncompressed digital video from a DVI device (🔗 page 35).

18 ➡ **DIGITAL AUDIO (OPTICAL) (output terminal)** — For use when connecting an amplifier with optical type digital audio input (🔗 page 33).

19 ➡ **DIGITAL AUDIO (COAXIAL) (output terminal)** — For use when connecting an amplifier with coaxial type digital audio input (🔗 page 33).

Learning about the remote control

Location of controls

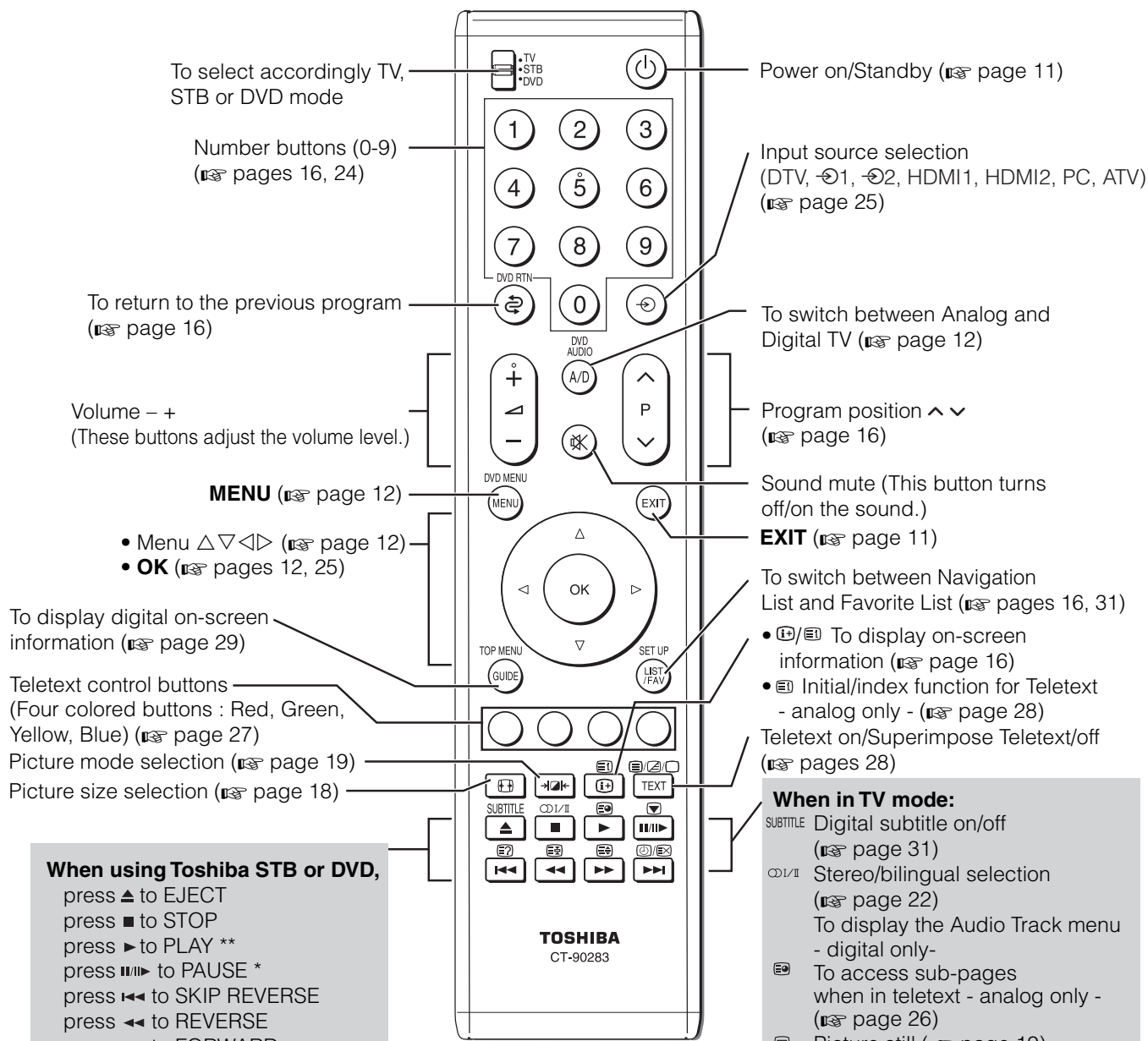

When using Toshiba STB or DVD,
 press ▲ to EJECT
 press ■ to STOP
 press ► to PLAY **
 press ||| to PAUSE *
 press ◀◀ to SKIP REVERSE
 press ◀ to REVERSE
 press ▶▶ to FORWARD
 press ▶▶ to SKIP FORWARD
 * For HDD-J35 and HDD-S36, this is also the PLAY key.
 ** Not applicable to HDD-J35 and HDD-S36, where the PLAY key is shared with PAUSE.

When using Toshiba DVD,
DVD RTN
 To return to the previous menu accessed.
DVD AUDIO
 To toggle between different audio modes.
DVD MENU
 To display the menu of DVD disc.
TOP MENU
 To display the title menu on DVD disc.
SET UP
 To access the on-screen Setup menu for setting adjustment.

When in TV mode:
 SUBTITLE Digital subtitle on/off (page 31)
 OLI/I Stereo/bilingual selection (page 22)
 To display the Audio Track menu - digital only -
 To access sub-pages when in teletext - analog only - (page 26)
 Picture still (page 19)
Teletext function - analog only -
 To reveal concealed text (page 28)
 To hold a wanted page (page 28)
 To enlarge teletext display size (page 28)
 • To select a page while viewing a normal picture (page 28)
 • To select the time display (page 28)

Turning the TV on

Switching on the TV

Connect the power cord to a wall outlet, the O/I power indicator lights in red (standby mode).

- 1 Press O/I on the remote control or O/I on the TV right side panel, the O/I power indicator lights in green.

Note:

If you watch black and white programs when the color system mode is set to Auto, color noise may appear on the screen. In this case select the appropriate Color system (For the system of each country or region, refer to pages 15 and 41).

Switching off the TV

- 1 Press O/I on the remote control or O/I on the TV right side panel to switch to the standby mode.

Notes:

- This TV is not fully disconnected from the main supply, as minute current is consumed even when O/I is turned off. When the TV will not be used for a long period of time, such as during vacation or travel, remove the power plug from the wall outlet.
- The TV will automatically turn itself off after approximately 15 minutes if it is tuned to a vacant channel or a station that completes its broadcast for the day. This function does not work in external input or Blue screen Off mode. The TV will automatically turn itself off after approximately 2 hours if you do not operate the TV after turned on by on timer function.
- If power is cut off while you are viewing the TV, the Last Mode Memory function turns on the TV automatically when power is applied again. If power is going to be off for a long time and you are going to be away from your TV, unplug the power cord to prevent the TV from turning on in your absence.

Tuning the TV for the first time

- digital only -

Before switching on the TV, put your decoder and media recorder to **Standby** if they are connected and ensure the antenna is connected. To setup the TV use the buttons on the remote control as detailed on page 10.

- 1 Press O/I , the **Welcome** screen will appear. This screen will appear the first time that the TV is switched on and each time the TV is reset.

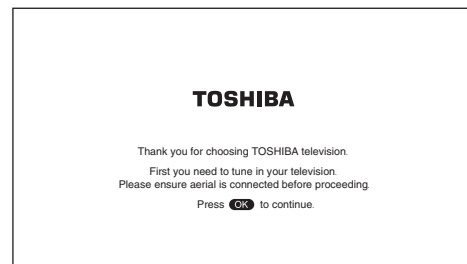

- 2 Press OK to proceed.
- 3 The **Select Location** screen will appear. Press ∇ or Δ to select the state in which you live.



- 4 Press OK to start tuning. The **Auto Scan** screen will appear and the TV will automatically start to search for available stations. The progress bar will move along the line.

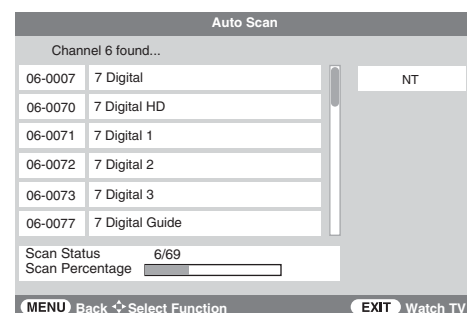

- 5 When the search is completed, the TV will automatically tune to the lowest logical channel number. See the following for more details on **Auto Scan**.

Note:

If you do not live in Australia, press EXIT at the **Select Location**.

Press MENU , then press \leftarrow or \rightarrow to select **PROFILE**.

Press ∇ or Δ to select **Time Zone** to set your time zone (see page 24).

Then use **Manual Scan** to start tuning (see page 14).

This integrated TV is equipped with both Digital and Analog system. To switch between Digital and Analog TV press **A/D** on the remote control.

Learning about the menu system

We suggest you familiarize yourself with the display charts before using the menu system:

- Press **(MENU)** to display menu, then press **<** or **>** to select main menu headings.
- Press **∇** or **△** to select an item.
- Press **<** or **>** to select or adjust setting.
- Press **(OK)** to display the next menu.

Displaying the DIGITAL SETTING chart

This menu will display only Digital TV selected.

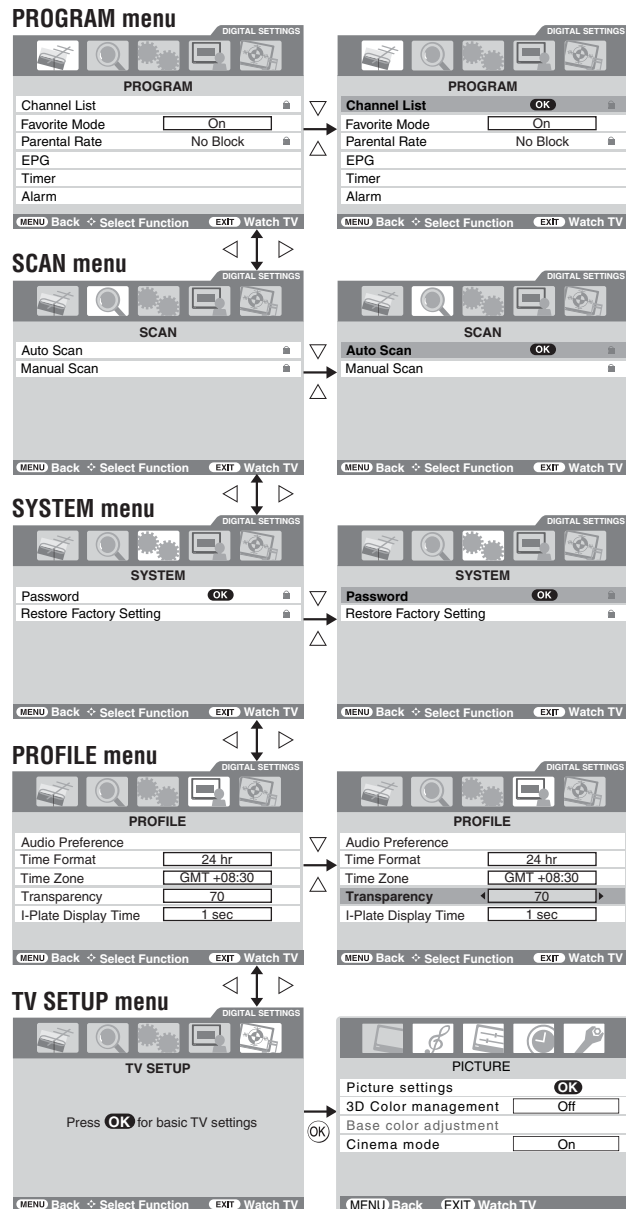

Displaying the TV SETUP menu chart

When Analog TV is selected, press **(MENU)** will display the TV SETUP menu.

When Digital TV is selected, select the TV SETUP menu from DIGITAL SETTING chart.

There will be some functions which not available in Digital TV and these will appear in gray scale.

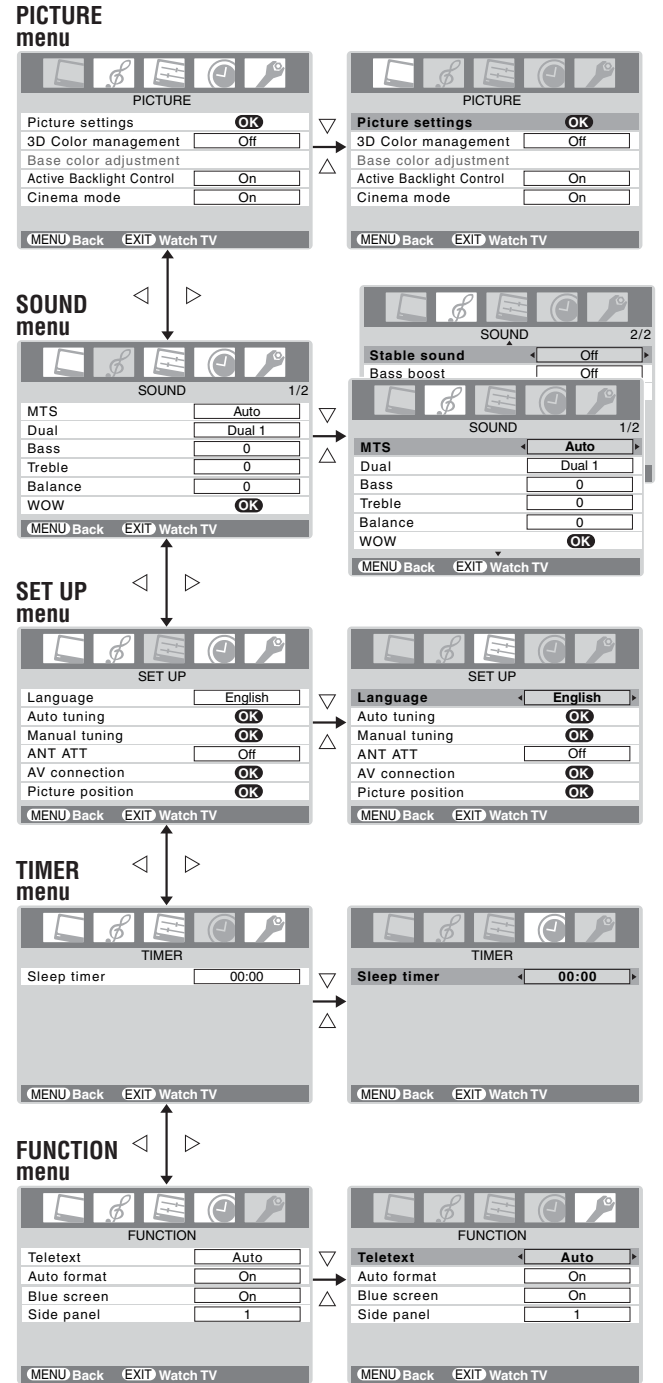

Notes for menu system:

- In the video input mode (⊖1, ⊖2), **Auto tuning** and **Manual tuning** are not available. Instead, **Manual setting** appears in the **SET UP** menu (ⓘ page 26).
- If you connect external equipment via component video source to external input, **Color system** selection in the **Manual setting** menu is not available.
- If you do not make a selection for a while, the menu display disappears automatically.
- If you want to close the menu display instantly, press (EXIT).
- To return to the previous menu, press (MENU).
- In the PC input mode, **PC Setting** appears in the **SET UP** menu (ⓘ page 38).
- In the 480i or 576i input signals mode, you can select the **Cinema mode** in the **PICTURE** menu (ⓘ page 21).
- When the color management function turns on (ⓘ page 20), you can select the **Base color adjustment** in the **PICTURE** menu.

Programming channels into the TV's channel memory

Auto scan - digital only -

As new services are broadcast, it will be necessary to re-tune the TV in order to view them.

Auto scan will completely re-tune the TV and can be used to update the channel list. It is recommended that Auto scan is run periodically to ensure that all new services are added. All stored programs and settings, including Timer entries, favorites and locked programs, will be lost.

- 1 Press (MENU) and ◀ or ▶ to select the **SCAN** menu.
- 2 Use ▼ to select **Auto Scan**.
- 3 Press (OK). If **Password Status** (ⓘ page 29) is **Enabled**, **Password** menu will be displayed. Enter your password using the **number** buttons or press 0000 (which is the default password).

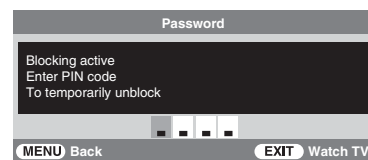

- 4 The **Select Location** will appear. Current location will be highlighted. Press ▼ or ▲ to select a state in which you live.
- 5 Press (OK), a confirmation screen will appear indicating that **All existing channels will be deleted**. **Continue?** select **Yes**.
- 6 Press (OK) to start Auto tuning.

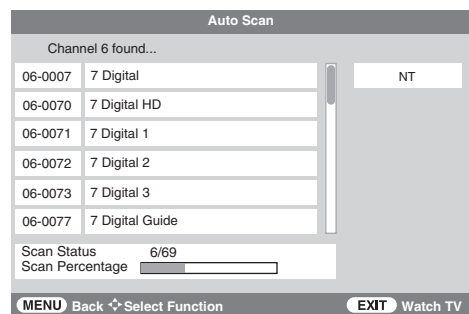

The above sample display shows **Auto Scan** in progress. The channel number is shown as “06-0007” etc., where “06” is the physical channel number and “0007” is the logical channel number (which is the 4-digit number you enter when changing channels).

- 7 When the search is complete, the TV will automatically tune to the lowest logical channel number.

Note:

After the **Auto scan**, the TV may have scanned identical channels being broadcast from different transmitters. You can verify this by **previewing** those channels in the **Channel List** with identical logical numbers and check on their physical channel numbers (page 30). If you do find channels with the same logical channel numbers but different physical channel numbers, it is recommended that you skip these duplicate channels and keep only one channel with the best signal strength as indicated by the SNR indicator in the I-Plate (page 16) display.

Manual scan - digital only -

If there were any missing channel after **Auto Scan**, these channels might be found by using **Manual Scan** described in this section. Also, if you do not live in Australia, you must use **Manual Scan** to scan those channels in your country.

- From the **SCAN** menu, press ∇ or \triangle to select **Manual Scan**, then press **OK**.
- Enter password using the **Number** buttons or press 0000 (which is the default password), then **Manual Scan** will appear.

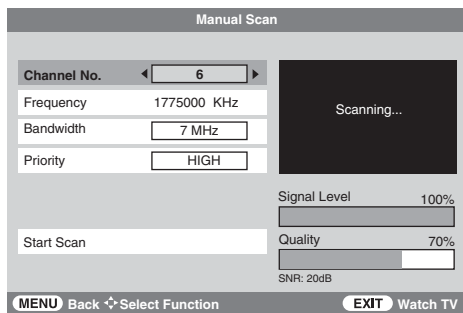

- Press ∇ or \triangle to select the item you wish to adjust. For Australia, to adjust **Frequency**, you may refer to the latest channel table from local dealer. And the **Bandwidth** is 7MHz and **Priority** should be set to **HIGH**. Then press ∇ or \triangle to select **Start Scan** and press **OK** to start scanning.
- If scanning was successful, **Get Channel Success** appeared for 2 seconds. Repeat to scan other channels as necessary.
- If scanning was unsuccessful, **Timeout Error** appeared. At this point you can rescan the signal or refer to the **Signal Level** bar and **Quality** for aligning the direction of the antenna to get the signal. Refer to your antenna installer if problem persists.

Notes:

- Signal level** refers to the input Radio Frequency (RF) signal strength as perceived by the TV. Note that too strong signal may cause erroneous readings. If you use an antenna booster and find that you still get a low signal level, your booster gain may be set too high. In this case, adjust the gain accordingly. You may also see the **No Signal** on the screen when the signal level is low.
- Quality** refers to the quality of the received digital signal. A high value of quality means that there are few errors in the signal. In the same way, a low value of quality implies that there are a large number of errors in the signal, which may cause distortions in video and audio.

Programming channels automatically**- analog only -**

First, use the Auto tuning function to preset all the active channels in your area automatically. Then, arrange the preset channels with the Manual tuning function so that you can tune into only desired channels.

- Press **MENU**, then press \triangleleft or \triangleright to display the **SET UP** menu.
- Press ∇ or \triangle to select **Auto tuning**.

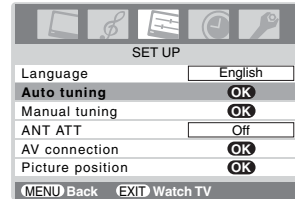

- Press **OK** to display the **Auto tuning** menu.

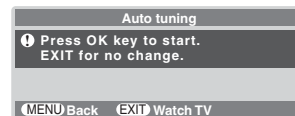

- Press **OK** to start the automatic search. The search will begin for all available stations.

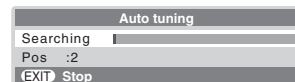

The slide bar will move along the line as the search progresses.

If you make a mistake, simply repeat steps 1-4 to start again from the beginning.

- When the automatic search is completed, the TV will automatically return to the first program position.
- Press ∇ or \triangle to view the programmed position.

Note:

When you preset the program channel which sound of broadcast transmission system adopts "M" system, the sound system may not be tuned correctly if the radio waves transmit badly. At that time, preset the channel by **Manual tuning**.

Manually setting channels in the channel memory - analog only -

Use the Manual tuning operation if desired channels cannot be preset with the Auto tuning or if you would like to preset channels to specific position numbers one by one.

- From the **SET UP** menu, press ∇ or \triangle to select **Manual tuning**.
- Press **OK** to display the **Manual tuning** menu. Press ∇ or \triangle to select the program position you want to arrange.

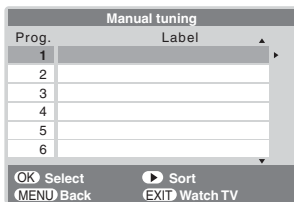

- Press **OK** to display the breakdown menu. Press \triangleleft or \triangleright to select an item, then press ∇ or \triangle to select the item as shown below.

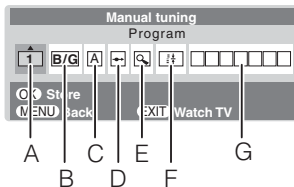

- Program position selection
- Sound system (see page 41)
- Color system (see page 41)
 - A** : Automatic (factory set), **P** : PAL, **S** : SECAM
 - N4** : NTSC 4.43 (MHz), **N3** : NTSC 3.58 (MHz)

If the color of a certain channel is abnormal, the automatic color system selection (A) may have malfunctioned, or sound system selection is wrong. In such a case, select another color and/or sound system (see page 41).
- Program position skip selection

Press ∇ or \triangle to turn the program position skip option on “ \curvearrowright ” or off “ \rightarrow ”.

The program position will then be skipped when you select channels with **P** \wedge or **P** \vee .

The “ \curvearrowright ” mark will appear beside a program position number when you use the **Number** button on the remote control.
- Channel search operation

Press \triangle to search up the band or ∇ to search down the band.

Press ∇ or \triangle repeatedly until your desired channel is displayed.

When a station/satellite is found, it will be displayed.

NEVER PRESS ANY OTHER BUTTONS WHILE THE SET IS TUNING.
- Auto Fine Tuning

Press ∇ or \triangle to turn the Auto Fine Tuning option on “ $\#$ ” or off “**0**”.

The Auto Fine Tuning function automatically corrects slight fluctuations when receiving signals.

Manual Fine Tuning

While the Auto Fine Tuning turn off “**0**”, press ∇ or \triangle so that the better picture and sound are obtained.

G. Label

Station labels appear under the program position display each time you turn on the TV, select a channel, or press **1**.

To change or create station labels:

- Press ∇ or \triangle repeatedly to select a character for the first space, then press \triangleright .

A-Z() * + , - . / 0-9 *

*(blank space)

- Repeat step 1) to enter the rest of the characters. If you would like a blank space in the label name, you must choose a blank space from the list of characters.

Press **OK** to store your settings.

Watching TV programs

Viewing Digital programs - digital only -

After you have tuned the TV, you have several ways to navigate through all programs:

- Press the **Number** buttons (a channel number has 4-digits) and you may omit the leading zeroes, which will be appended automatically; (Please note that if you have channels with different frequencies but the same channel number, the TV will always tune to the first channel that has been stored into the channel database. To view the other duplicating channels, you can select the channels from the **Navigation List** (see below) or use the **P[^] / P^v** buttons.)
- Press **P[^] / P^v** to view the previous and next program. The channels are arranged in ascending order according to the channel number.
- Press **LIST FAV** twice to display **Favorite channel** list and press **▽** or **△** to select a program, then press **OK** to view the favorite program. Alternatively activating the **Favorite Mode**, then press **P[^] / P^v** to select channels in **Favorite channel** list. See page 31 for more details.

Selecting channel from Navigation List

- digital only -

- 1 When viewing in Digital TV, press **LIST FAV** to display the **Navigation List**.

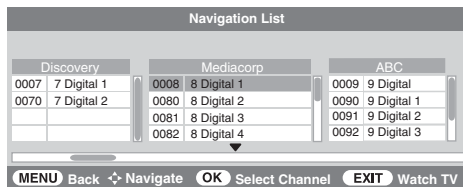

- 2 Press **▽**, **△**, **◀** and **▶** to select previewed program, then press **OK**.
- 3 Press **EXIT** to exit the menu and watch the previewed channel.
- 4 Press **LIST FAV** twice to display **Favorite channel** list.

Changing the program position - analog only -

- 1 Enter the desired program position number using the **Number** buttons on the remote control. For program positions below 10, use 0 and the required number e.g., for program position 1.
- 2 You can also change the program position by using **P[^]** or **P^v**.
The program position will be displayed on the screen with the Mono/Stereo/Dual audio status.

Note:

The program position selection change between different format channels takes several seconds.

Switching between two program positions

You can switch two program positions without entering actual position number each time.

- 1 Select the first program position you want to view.
- 2 Select the second program position with the **Number** buttons (0-9).
- 3 Press **↺**. The previous channel will be displayed.

Each time you press **↺**, the TV will switch back and forth between the two program positions.

Selecting the menu language - analog only -

Choose from 9 different languages (English, Chinese (CS), Malay, Thai, Vietnamese, Russian, Arabic, Persian or French) for the On-Screen-Display.

- 1 Press **MENU**, then press **◀** or **▶** to display **SET UP** menu.
- 2 Press **▽** or **△** to select **Language**.
- 3 Press **◀** or **▶** to select the desired language.

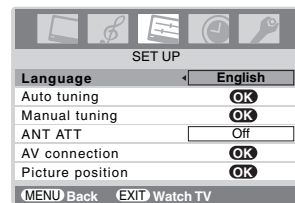

Displaying the on-screen information

- analog only -

- 1 Press **ⓘ** to display the following on-screen information.



The information will disappear in 6 seconds.

- Program position or external input mode selected
- Program skip on/off information
- Label (if set)
- Mono/Stereo/Dual audio status

- 2 To close the display instantly, press **ⓘ** again.

On-screen information - digital only -

When viewing in Digital TV, the on-screen information (**I-Plate**) will give the details of the channel program currently being viewed.

- 1 Press **ⓘ+**, to display the **I-Plate**.

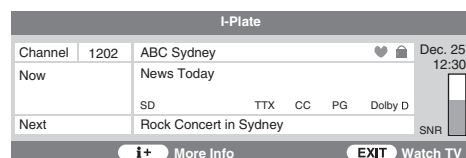

I-Plate contains the following information:

- Current Channel Number
- Channel Name
- Favorite status (indicated by a heart icon)
- Channel Lock status (indicated by a padlock icon on first I-Plate)
- Now and Next Program Names
- Current date and time
- Received program video format (SD/HD)
- Teletext availability (indicated by TTX)
- Subtitle (closed-caption) availability (indicated by CC)
- Parental Guidance code (PG, MA, G, R, etc.)
- Dolby® Digital audio track availability (indicated by **Dolby D**)
- SNR (which stands for Signal-to-noise ratio. A high SNR value means you have a reasonably good reception.)

2 Press **i+** again to display the extended program information (**Now** and **Next**) of the current TV channel.

Notes:

- The **Now** and **Next** information may not be present for some channels.
- When the **Parental Rate** is set to block, the padlock icon will appear next to the Parental Guidance code.



3 Press **i+** to switch between **Now** and **Next** extended program information.

4 To close the display instantly, press **EXIT**. Otherwise, the information will disappear after the expiration of the set display time.

Setting the I-Plate Display Time -digital only-

From the **PROFILE** menu, press ∇ or \triangle to select **I-Plate Display Time**, then press \triangleleft or \triangleright to set the duration for which **I-Plate** will stay on the screen.

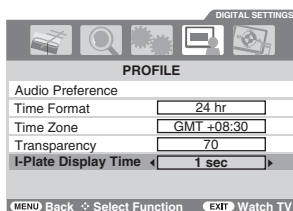

Note:

When you turn on the TV from standby, the **I-Plate** will be displayed for a slightly shorter duration than the value set in the **Display Time** setting.

Setting the Time Format

From the **PROFILE** menu, press ∇ or \triangle to select **Time Format**, then press \triangleleft or \triangleright to select the time to be displayed **24hr** or **AM/PM** format.

Sorting program position -analog only-

- The TV is capable of receiving a number of different channels depending upon where you live.
- Program sorting is an easy way of storing each channel on the program position of your choice.

Ex.: To swap channel ABCD (Prog.1) for channel MNOP (Prog.4):

1 Press **MENU**, then press \triangleleft or \triangleright to display the **SET UP** menu.

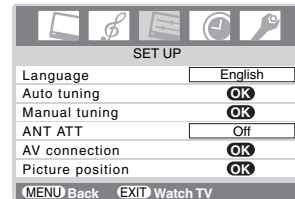

2 Press ∇ or \triangle to select **Manual tuning** menu, then press **OK**.

3 Press ∇ or \triangle to select the channel **ABCD**, then press \triangleright .

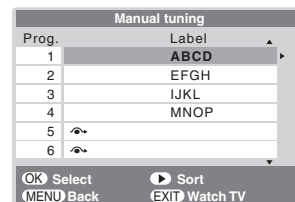

4 Press ∇ to select the new position "4", then press \triangleleft .

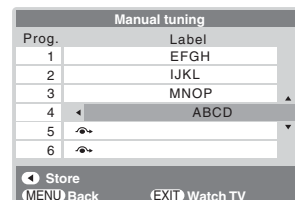

5 Press \triangle to select the channel **MNOP**, then press \triangleright .

6 Press \triangle to select the new position "1", then press \triangleleft .

7 Confirm new **Manual tuning** menu.

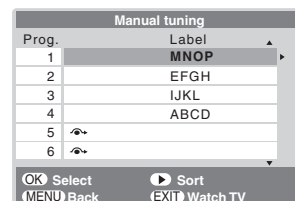

Using the TV's features (General)

Picture adjustment

Selecting the picture size

- 1 Press **Ⓜ** to display the picture size list, then press **▽** or **△** to select the appropriate picture size (or press **Ⓜ** repeatedly to select required picture size directly).

Ex. HDMI 1080i input signal

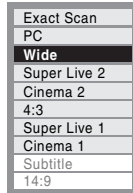

- 2 Press **Ⓚ**.

Wide

Use this setting when watching a wide-screen DVD, wide-screen video tape or a 16:9 broadcast (when available). Due to the range of wide-screen formats (16:9, 14:9, 20:9 etc.), you may see bars on the top and bottom of the screen.

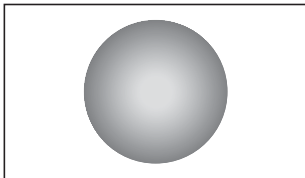

Super Live 2

When receiving "side panel format" signal, this setting will enlarge the image to fit the screen by stretching the image vertically and horizontally, holding the better proportions at the center of the image. Also the black bars on the both sides of the screen will eliminate or reduce.

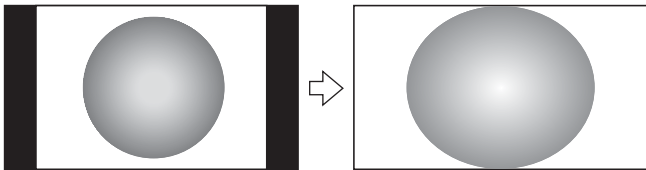

Cinema 2

When watching "all sides panel format" films/video tapes, this setting will eliminate or reduce the black bars on all the sides of the screen by zooming in and selecting the image without distortion.



4:3

Use this setting to view a true 4:3 broadcast.

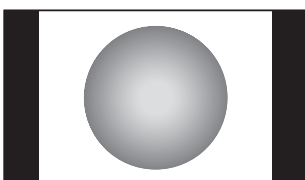

Super Live 1

When receiving "4:3 format" signal, this setting will enlarge the image to fit the screen by stretching the image vertically and horizontally, holding the better proportions at the center of the image.

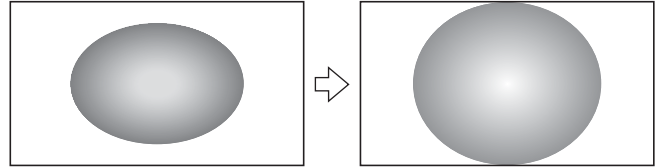

Cinema 1

When watching "letterbox format" films/video tapes, this setting will eliminate or reduce the black bars at the top and bottom of the screen by zooming in and selecting the image without distortion.

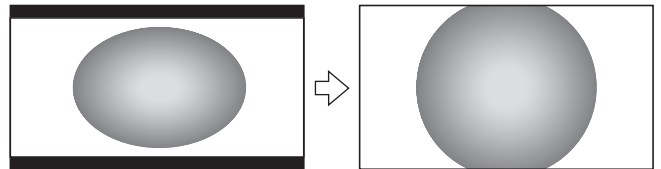

Subtitle

When subtitles are included on a letterbox format broadcast, this setting will raise the picture so that the most of text is displayed.

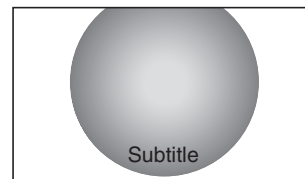

14:9

Use this setting when watching a 14:9 broadcast.

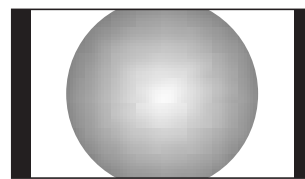

Exact Scan

When receiving 1080i or 1080p signal format, this setting will display the image correctly without distortion or picture clipping.

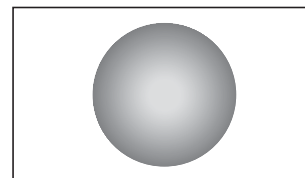

PC

Use this setting for PC via HDMI. When receiving 1080i, 1080p or 720p signal format of HDMI input, this setting will display the image correctly without distortion or picture clipping.

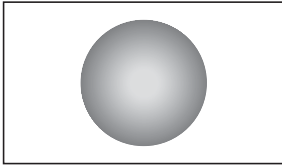

Notes:

- Using the special functions to change the size of the displayed image (e.g. changing the height/width ratio) for the purpose of public display or commercial gain may infringe on copyright laws.
- If the aspect ratio of the selected format is different from the one of the TV transmission or video program, it can cause a difference in vision. Change to the correct aspect ratio picture size.
- In the PC input mode (see page 25), the picture size selection is wide or normal only.
- When using the PC input mode, the moving image quality may be deteriorated.
- In the 720p input signal mode, the picture size selections are **Wide**, **Super Live 2**, **Cinema 2**, **4:3**, **Super Live 1** and **Cinema 1**.
- In Digital TV, the picture size selections are **Super Live 1**, **Cinema 1**, **Wide**, **Super Live 2**, **Cinema 2** and **4:3**. When receiving 1080i or 1080p signal, you can additionally choose **Exact Scan**.
- When using **Exact Scan** you may observe a shift in picture position. This is due to the signal source and is not a defect of the TV.
- When DTV teletext (see page 28) or Subtitle (see page 31) is displayed, the picture size selection is not available.

Using the picture still

- Press to freeze the picture.

Even if an image is frozen on the TV screen, the pictures are running on the input source. Audio continues to be output as well.

To return to a moving picture, press again.

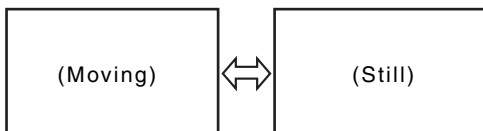

Notes:

- If you use this function except for the purpose of your private viewing and listening, it may infringe the copyright protected by the copyright laws.
- In the PC input mode (see page 25), this function is not available.

Adjusting the picture position - analog only -

Adjustment to the position of the picture may be made to suit your viewing preferences.

- 1 Press , then press or to display the **SET UP** menu.
- 2 Press the or to select **Picture position**.

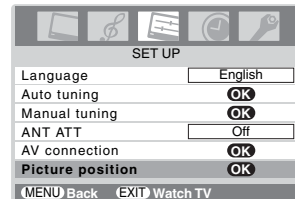

- 3 Press , then press or to select an item you want to adjust.

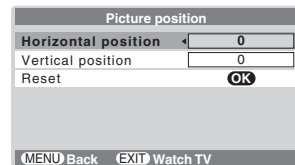

- 4 Press or to adjust the settings as required.



Note:

When the picture format is in Wide or 4:3 mode, only the Horizontal position can be adjusted.

Resetting the picture position - analog only -

This function resets your picture position settings to the factory settings.

- 1 From the **Picture position** menu, press or to select **Reset**.
- 2 Press .

Selecting the picture mode

You can select the picture quality instantly among three preset modes and one user-set mode.

- Press to select the desired picture quality.

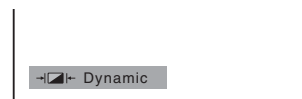

Mode	Picture quality
Dynamic	bright and dynamic picture
Standard	standard picture
Mild	soft picture
Memory	the picture quality you set

Note:

In the PC input mode (see page 25), this mode is not available.

Adjusting the basic picture quality

- 1 In Digital TV, press (MENU), then press ◀ or ▶ to display the **TV set up** then press (OK).
- 2 Press ◀ or ▶ to display the **PICTURE** menu.
- 3 In Analog TV, press (MENU) and ◀ or ▶ to display the **PICTURE** menu.

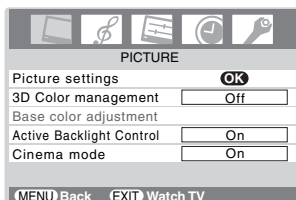

- 4 Press ▼ or ▲ to select the **Picture settings** menu, then press (OK).

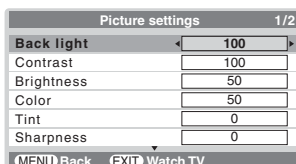

- 5 Press ▼ or ▲ to select an item you want to adjust, then press ◀ or ▶ to adjust the settings as required.



Selection	◀ Pressing	▶
Back light	darker	brighter
Contrast	lower	higher
Brightness	darker	brighter
Color	paler	deeper
Tint	reddish	greenish
Sharpness	softer	sharper

Notes:

- The **Tint** may only be adjusted on NTSC signal.
- In the PC input mode (page 25), **Color**, **Tint** and **Sharpness** modes are not available.

Activating the black stretch

This function increases the strength of dark areas of the picture which improves definition.

- 1 From the **Picture settings** menu, press ▼ or ▲ to select **Black stretch** on the 2nd page.

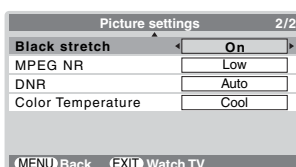

- 2 Press ◀ or ▶ to select **On** or **Off**.



Note:

In the PC input mode (page 25), this mode is not available.

Activating the MPEG NR (Noise Reduction)

If the receiving signal of MPEG is a mosquito (grained) noise depending on the compression and conversion, the noise may be reduced when using this function.

- 1 From the **Picture settings** menu, press ▼ or ▲ to select **MPEG NR** on the 2nd page.
- 2 Press ◀ or ▶ to select **Off**, **Low**, **Middle** or **High**.



Note:

In the PC input mode (page 25), this mode is not available.

Activating the DNR (Digital Noise Reduction) - analog only -

If the receiving signal is weak and the picture is blurry, the picture may be improved when using this function.

- 1 From the **Picture settings** menu, press ▼ or ▲ to select **DNR** on the 2nd page.
- 2 Press ◀ or ▶ to select **Auto**, **Off**, **Low**, **Middle** or **High**.



Selecting the color temperature

You can change the tone of the picture by selecting from three preset color temperatures: **Cool**, **Normal** or **Warm**.

- 1 From the **Picture settings** menu, press ▼ or ▲ to select **Color Temperature** on the 2nd page.
- 2 Press ◀ or ▶ to select mode you prefer.



Cool: Lends a blue hue to the picture.

Normal: Neutral

Warm: Lends a red hue to the picture.

Adjusting the color management

You can adjust the picture color quality by selecting from 6 base color adjustments : **Red**, **Green**, **Blue**, **Yellow**, **Magenta** or **Cyan**.

- 1 Press (MENU), then press ◀ or ▶ to display the **PICTURE** menu.
- 2 Press ▼ or ▲ to select **3D Color management**, then press ◀ or ▶ to select **On**.
- 3 Press ▼ or ▲ to select **Base color adjustment**.
- 4 Press (OK), then press ▼ or ▲ to select an item you want to adjust.

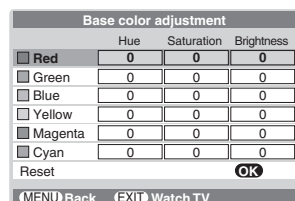

- 5 Press \triangleright , then press \triangleleft or \triangleright to select **Hue**, **Saturation** or **Brightness**.

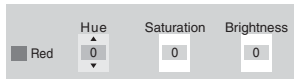

- 6 Press ∇ or \triangle to adjust the settings as required.

Notes:

- If you select color management **Off** mode, this mode is not available.
- In the PC input mode (see page 25), this mode is not available.

Resetting the base color adjustment

The Reset function adjusts the base color adjustment to the factory settings.

- 1 From the **Base color adjustment** menu, press ∇ or \triangle to select **Reset**.
- 2 Press OK .

Using the active backlight control

In order to improve screen visibility, the active backlight control sets the screen brightness automatically during dark scenes.

- 1 From the **PICTURE** menu, press ∇ or \triangle to select **Active Backlight Control**.
- 2 Press \triangleleft or \triangleright to select **On** or **Off**.

Using the cinema mode - analog only -

A movie film's picture runs at 24 frames a second, whereas movie software such as DVD, etc., that you enjoy watching on television at home runs at 30 (NTSC) or 25 (PAL) frames a second. To convert this signal to reproduce a smooth motion and picture quality, select the **On** mode.

Effective signal and setup conditions:

- When the Video input mode is selected.
- When the input signal format is 480i and 576i signals.

- 1 Press MENU , then press \triangleleft or \triangleright to display the **PICTURE** menu.

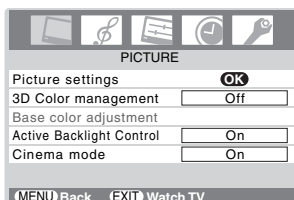

- 2 Press ∇ or \triangle to select **Cinema mode**, then press \triangleleft or \triangleright to select **On** or **Off**.

Note:

When a DVD movie with subtitle is playing back, this mode may not work correctly.

Using the auto format

When the TV receives a true HDMI signal picture and the auto format is On, it will automatically be displayed in HDMI signal format, irrespective of the TV's previous setting. When in Digital TV, the display format will follow the broadcasted format.

- 1 Press MENU , then press \triangleleft or \triangleright to display the **FUNCTION** menu.

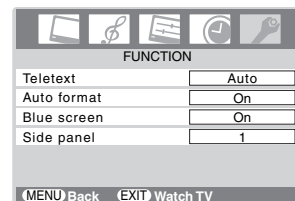

- 2 Press ∇ or \triangle to select **Auto format**, then press \triangleleft or \triangleright to select **On** or **Off**.

Activating the ANT ATT (Antenna Attenuation)

If the signal being received by the TV is too strong, this may result in picture interference and/or buzzing sound. Setting **ANT ATT** to **On** reduces signal strength, and can help to remove the interference.

- 1 From **SET UP** menu, press ∇ or \triangle to select **ANT ATT**.
- 2 Press \triangleleft or \triangleright to select **On** or **Off**.

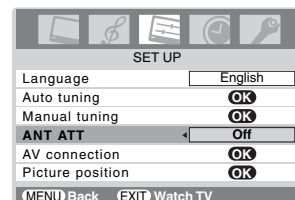

Sound adjustment

Setting the MTS (Multi-channel TV Sound)

- analog only -

Auto mode

The MTS Auto mode automatically recognize stereo/bilingual programs depending on the broadcast signal.

- 1 Press **MENU**, then press **◀** or **▶** to display the **SOUND** menu.

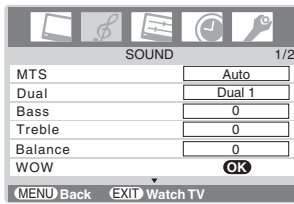

- 2 Press **▽** or **△** to select **MTS**, then press **◀** or **▶** to select **Auto** or **Mono**.

Mono mode

If you experience noise or poor reception of any stereo/bilingual program, set the **MTS** mode to **Mono**. Noise will be reduced and reception may improve.

Note:

If you experience noise with a particular program on whose channel reception is usually good, try setting MTS mode to **Auto**, then switch **Ⓢ** to **◯ Mono** (monaural) (see page 22).

Selecting the dual 1 or dual 2 mode

- analog only -

You can hear only dual 1 or dual 2 sound selected, whenever bilingual programs are received.

- 1 Press **MENU**, then press **◀** or **▶** to display the **SOUND** menu.
- 2 Press **▽** or **△** to select **Dual**, then press **◀** or **▶** to select **Dual 1** or **Dual 2**.

Notes:

- When the MTS setting is in **Mono** mode, the **Dual** menu is not selectable.
- The **Dual** menu setting status remains even if the TV is turned off.

Selecting the stereo programs - analog only -

- 1 When a stereo program is received, **Ⓢ Stereo** appears.
- 2 Press **Ⓢ** to select the stereo/monaural mode. **Ⓢ Stereo** and **◯ Mono** appear cyclically on the screen.



Selecting the bilingual programs - analog only -

- 1 When a bilingual program is received, **●◯ Dual** appears.
- 2 Press **Ⓢ** to select the sound to be heard. The sound differs according to the transmission system: NICAM or German stereo/bilingual broadcast.



Display	Sound to be heard	
	NICAM	German stereo/bilingual broadcast
●◯ Dual 1	Sub I sound	Main sound
◯● Dual 2	Sub II sound	Sub sound
◯ Mono	Main sound	—

Note:

These settings are not stored in the TV memory.

Adjusting the sound quality

- 1 From the **SOUND** menu, press **▽** or **△** to select an item you want to adjust.
- 2 Press **◀** or **▶** to adjust the settings as required.



Selection	◀ Pressing	▶
Bass	weaker	stronger
Treble	weaker	stronger
Balance	decreases the right channel	decreases the left channel

Using the SRS WOW[®] surround sound

SRS WOW[®] is a special combination of SRS Labs audio technologies that creates a thrilling surround sound experience with deep, rich bass from stereo sound sources. Your TV's audio will sound fuller, richer and wider.

WOW[®] consists of three features; SRS 3D[®], SRS FOCUS[®], and SRS TruBass[®], being turned on.

- 1 From the **SOUND** menu, press ∇ or \triangle to select **WOW**, then press \odot .

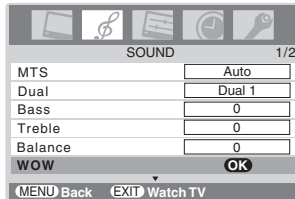

- 2 Press ∇ or \triangle to select an item you want to adjust, then press \triangleleft or \triangleright to adjust the settings as required.

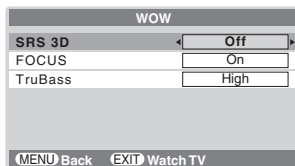

SRS 3D: To turn the surround effect **On** or **Off**.

FOCUS: To turn the vocal emphasis effect **On** or **Off**.

TruBass: To select the desired bass expansion level (**Off**, **Low** or **High**).

Notes:

- If the broadcast is monaural, the SRS 3D[®] effect does not work.
- WOW, SRS and \odot symbol are trademarks of SRS Labs, Inc.
- WOW technology is incorporated under license from SRS Labs, Inc.
- The SRS WOW[®] effect is active only when the sound outputs from the speaker.

Using the stable sound

The Stable sound function limits the highest volume level to prevent extreme changes in volume when the signal source changes (for example, to prevent the sudden increase in volume that often happens when a TV program switches to a commercial).

- 1 Press \odot , then press \triangleleft or \triangleright to display the **SOUND** menu.
- 2 Press ∇ or \triangle to select **Stable sound** on the 2nd page.

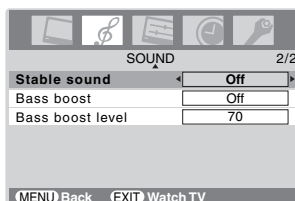

- 3 Press \triangleleft or \triangleright to select **On** or **Off**.

Note:

The Stable sound effect is active only when the sound outputs from the speaker.

Using the bass boost

- 1 From the **SOUND** menu, press ∇ or \triangle to select **Bass boost** on the 2nd page.
- 2 Press \triangleleft or \triangleright to select **On**.

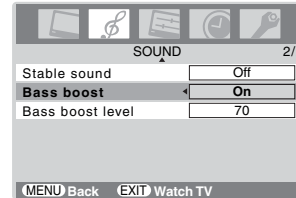

- 3 Press ∇ to select **Bass boost level**.
- 4 Press \triangleleft or \triangleright to adjust the Bass boost level.
- 5 To turn off the Bass boost, press ∇ or \triangle to display **Bass boost**, then press \triangleleft or \triangleright to select **Off**.

Note:

The Bass boost effect is active only when the sound outputs from the speaker.

Activating blue screen

With the blue screen function **On**, the screen will automatically turn blue and the sound will be muted when no signal is being received.

- 1 Press \odot , then press \triangleleft or \triangleright to display the **FUNCTION** menu.
- 2 Press ∇ or \triangle to select **Blue screen**.

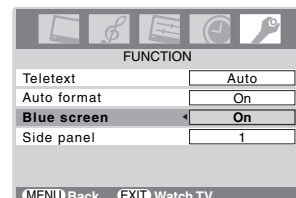

- 3 Press \triangleleft or \triangleright to select **On** or **Off**.

Note:

In the PC input mode (page 25), this function is not available.

Adjusting the brightness of side panel

You can adjust the brightness of side panel in 14:9 or 4:3, etc. mode.

- 1 From the **FUNCTION** menu, press ∇ or \triangle to select **Side panel**.
- 2 Press \triangleleft or \triangleright to adjust the settings as required.



The timers

Setting the Time zone - digital only -

This function allows you to manually set the time zone and override the location that you have chosen during Auto Scan. This is to be used when you move out of Australia to country with different time zone. Please note that if you manually change the time zone setting, all existing entries in the program timer will become invalid as they are still based on the old time zone. It is recommended that you delete all the entries in the program timer before proceeding with steps described below.

- 1 From the **PROFILE** menu, press ∇ or Δ to select **Time zone**.
- 2 Press \triangleleft and \triangleright to select the local time zone.

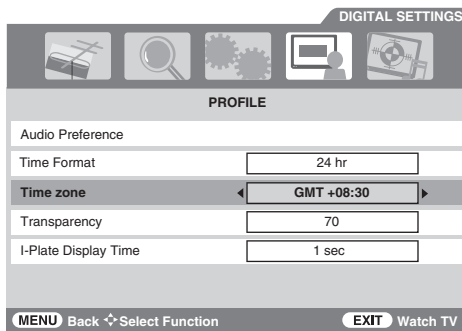

Program Timer - digital only -

This function will set the TV to go to a specific channel at a certain time. It can be used to view a particular program, or by setting the mode to daily or weekly, can be used to view a series of programs.

- 1 Press MENU , then \triangleleft or \triangleright to select the **PROGRAM** menu.
- 2 Press ∇ or Δ to select **Timer**, then press OK .

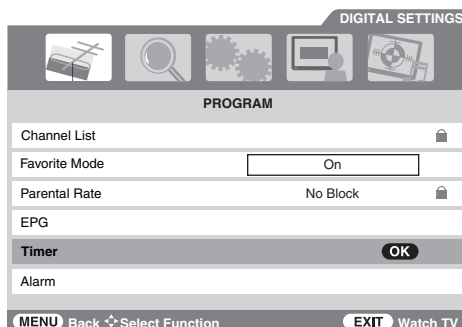

- 3 Press ∇ or Δ to select an empty slot to program a timer or any existing program to be edited, then press OK .

Ch. No.	Channel Name	Mode	Date	Start	End
0006	Channel 5	Weekly-Sat	18 Nov 2008	20:30	21:00
0007	Channel News Asia	Daily	11 Nov 2008	00:00	00:00
0008	Channel 8	Daily	11 Nov 2008	00:00	00:00
0009	Channel U	Once	11 Nov 2008	00:00	00:00

MENU Back Select Function OK Edit Timer Delete EXIT Watch TV

- 4 Press ∇ and Δ to select **Ch. No.** and \triangleleft or \triangleright to choose the channel you want. Press ∇ and Δ to select **Mode** and \triangleleft or \triangleright to choose **Once**, **Daily** or **Weekly**. Then use the **Number** buttons to set time for **Date**, **Start** and **End** in 24-hour format.

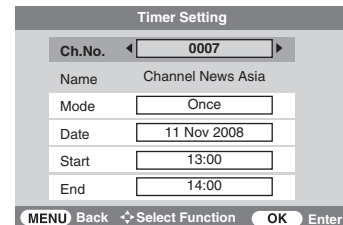

- 5 Press OK to save. If you have selected a locked channel or activated **Parental Rate**, enter password when prompted.

Note:

If the new entry causes a conflict with the existing entries (i.e. overlapping recording time), the new entry will not be saved.

To delete a selected entry:

Press the Red button, then use ∇ or Δ to select **Yes**, then press OK (All fields will be cleared).

Notes:

- When a timed program is about to start, an information screen will appear indicating the change of current channel. The menus and other channels will not be available during the timed program unless the program timer is cancelled. When the program timer expires, the TV switches to the channel from which it is switched from.
- If timer action occurs when the TV is in standby, the TV will turn on but no picture is seen and no sound is heard. Selected digital channel will be at the AV OUTPUT terminals (page 9). The selected channel can be watched or recorded via the AV OUTPUT terminals.
- When the timer table is empty, the DTV timer LED (page 8) will be off. When the timer table contains at least one entry, the DTV timer LED will be set to red. If timer action is in progress, the DTV timer LED will be changed from red to yellow.
- If Menu or EPG is still open when timer action is scheduled to start, the Menu or EPG will be closed automatically and then the timer will start.
- The correct operation of the Timer depends on the information received from Broadcaster's stream. The time, and the deletion of service are examples of such information. When broadcaster decides to delete any channel, the respective entries will then be deleted from the Timer-table. It is not the malfunction of the TV.

Setting the Alarm - digital only -

This function will turn on the TV to go to a specific TV mode or channel at a certain time.

- 1 From the **PROGRAM** menu.
- 2 Press ∇ or Δ to select **Alarm**, then press OK .

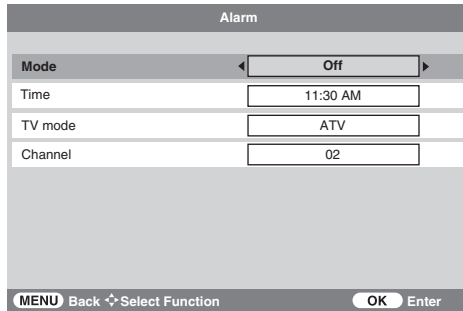

- 3 Press ∇ or Δ to select **Mode** and \leftarrow or \rightarrow to choose **Off, Once, Mon-Fri** or **Daily**.
- 4 Press ∇ or Δ to select **Time** and \leftarrow or \rightarrow to select time for TV to wake up in 10-minute increments.
- 5 Press ∇ or Δ to select **TV mode** and \leftarrow or \rightarrow to select the TV mode or input source you want to adjust.
- 6 If **TV mode** is set to **ATV** or **DTV**, press ∇ or Δ to select **Channel** and \leftarrow or \rightarrow to select desired channel to be turned on.
- 7 Press OK to save the above settings. If you have selected a locked channel or activated **Parental Rate**, enter password when prompted.
The \odot Alarm Timer LED on the front of TV lights in green.

Notes:

- You must press OK to save the Alarm settings before you exit the menu, otherwise all newly set values will be discarded.
- If TV is already turned on when Alarm is activated, the TV will simply switch to the specific TV mode or channel at the Alarm start time.
- If TV is already running the Program Timer when Alarm is set to activate on DTV mode, on Alarm activation the Alarm will only turn on the TV (if it was in standby) but not switch to the channel specified in the Alarm setting.
- If TV is already running the Program Timer when Alarm is set to activate on a TV mode other than DTV, the Alarm will perform normally.
- If you do not press any button on the side panel of the TV or the remote control within 2 hours after Alarm is activated, the TV will enter standby automatically.

Setting the sleep timer

The Sleep timer is especially useful if you want the TV to turn itself off after a selected period of time.

- 1 Press MENU , then press \leftarrow or \rightarrow to display the **TIMER** menu.



- 2 Press ∇ or Δ to select **Sleep timer**.
- 3 Press **Number** buttons (0-9) to set the time period to turn off the TV. Alternatively, press \leftarrow or \rightarrow to set the time period. The timer display will set in blocks of 10 minutes to 12 hours and 50 minutes. If you press and hold \leftarrow or \rightarrow to set the time period, timer display will set in blocks of 30 minutes up to 12 hours 30 minutes.
- 4 Press EXIT to start the timer.

Selecting the video input source to view

- 1 Press \odot on the remote control to display the video input mode list, then press ∇ or Δ to select appropriate input source (or press \odot on the TV side panel or \odot on the remote control repeatedly to select required input source directly). In Analog TV, you may also press OK to display the video input mode list.

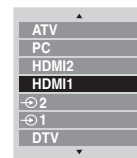

Ex. PC VGA mode



- 2 Press OK .
 \odot 1 (\odot 1), video 1 input) or \odot 1C (component video input),
 \odot 2 (\odot 2), video 2 input) or \odot 2S (S-video input),
 HDMI1, HDMI2 (\odot HDMI1 or \odot HDMI2, HDMI input),
 PC (\odot RGB/PC, PC input)
 ATV (Analog TV)
 DTV (Digital TV)

Setting the manual setting menu - analog only -

- 1 Press **MENU**, then press **◀** or **▶** to display the **SET UP** menu.

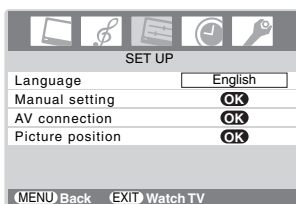

- 2 Press **▽** or **△** to select **Manual setting**, then press **OK**.
- 3 Press **◀** or **▶** to select an item, then press **▽** or **△** to select the item as shown below.

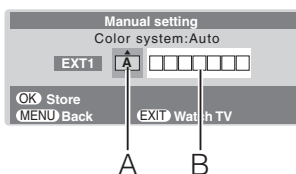

A. Color System

Confirm that color system is set to “**A**” (Auto). If not, select “**A**” with **▽** or **△**.

B. Video label

The video label allows you to label each input source for your TV.

To change or create video labels:

- 1) Press **▽** or **△** repeatedly to select a character for the first space, then press **▶**.

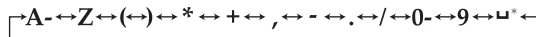

*(blank space)

- 2) Repeat step 1) to enter the rest of the characters. If you would like a blank space in the label name, you must choose a blank space from the list of characters.
- 3) Press **OK** to store your settings.

Teletext in Analog TV

This TV has a multi-page teletext memory, which takes a few moments to load and it offers two ways of viewing Teletext **Auto** and **LIST** which are explained below.

Setting up the teletext mode

To select teletext mode:

Select a channel position with the desired teletext service.

- 1 Press **MENU**, then press **◀** or **▶** to display the **FUNCTION** menu.

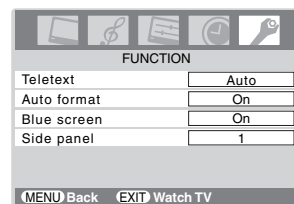

- 2 Press **▽** or **△** to select **Teletext**, then press **◀** or **▶** to select **Auto** or **LIST** mode.

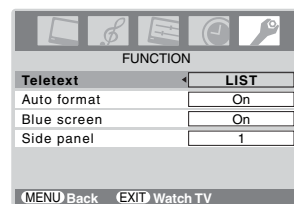



Note:

When you are watching the teletext program, **SET UP** menu and **FUNCTION** menu are not selectable.

Teletext general information

button:

Pressing  once will bring up the teletext screen. Press again to superimpose the teletext over a normal broadcast picture. Press again to return to normal TV mode. You need to return to normal viewing if you wish to change channels.

When you first press  to access the text service, the first page you see will be the initial page.

In **Auto** mode, this displays the main subjects available and their relevant page numbers.

In **LIST** mode, you will see the page numbers currently stored on the **each color** button.

Sub-pages:

Once in this chosen page, if there are sub-pages they will automatically load into memory without changing the one you are reading. If there are many sub-pages, it will take a long time for them all to load and this will depend on the speed with which the broadcaster transmits them.

To access the sub-pages in memory, press , then use **P^** / **Pv** to view them.

Note:

If you press **▽** while the picture mode is activated, this mode will be cancelled.

Using Auto mode

There are two Modes: **Auto** will display FASTEXT or TOPTXT, if available. **LIST** will display your four favorite pages. In either mode, as an alternative to the colored buttons, you can access a page by entering a 3-digit number, using the **Number** buttons on the remote control, or to advance to the next page, press **P** ^ , to go back to the previous page press **P** v .

To change between **Auto** and **LIST**, see above.

- Press / /  to access teletext.

Ex. FASTEXT

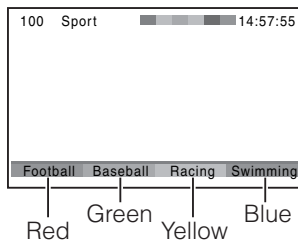

If FASTEXT or TOPTXT is available, you will see 4 colored titles at the bottom or top of the TV screen respectively. To access any given subject, simply press the relevant colored button on the remote control.

If FASTEXT or TOPTXT is not available, you can access any page simply by entering a 3-digit page number or pressing the corresponding colored button.

For further information on your particular text system(s), see the broadcast teletext index page or consult your local Toshiba dealer.

Using LIST mode

- 1 Press / /  to access teletext.

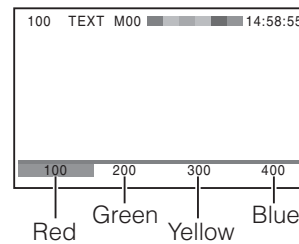

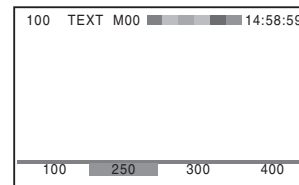

The four choices at the bottom of the screen are now number – **100, 200, 300** and **400**, which have been programmed into the TV's memory.

- 2 To view these pages, use the colored prompt buttons. e.g. press the Green button to view page 200.
- 3 If you want to change these stored pages, press the colored button for the color you want to change. e.g. Press the Green button and enter the 3-digit number.



This number will change in the top left of the screen and in the colored highlight.

- 4 Press  to store your choice. The bars at the bottom of the screen will flash white.
- 5 You may view other pages by simply entering the 3-digit page number – but NEVER press  or you will lose the favorite already stored.

Teletext buttons on the remote control

Below is an introduction to the teletext buttons on your remote control and their functions.

To display an index/initial page:

In Auto-mode

Press  to access the index page. The one displayed is dependant on the broadcaster.

In LIST-mode

Press  to return to the 100 page or initial page.

To reveal concealed text:

Some pages cover topics such as quizzes and jokes. To discover the solutions, press .





To hold a wanted page:

This function is included as it is part of the broadcast teletext system but you will not need it as this TV allows you to control the display of sub-pages.



To enlarge the teletext display size:

Press  once to enlarge the top half of the page, press again to enlarge the bottom half of the page. Press again to revert to the normal size.



/ **To select a page while viewing a normal picture:**

When in teletext mode, if a page selection is made and then / is pressed, a normal picture will be displayed. The TV will indicate when the page is present by displaying the title bar of the text page at the top of the screen. Press // to view the page.

Note:

It will not be possible to change program position while in Teletext mode, you will have to cancel the teletext first by pressing // to return to a normal TV picture.

To select the time display:

If you press / while watching a normal TV broadcast, you will see a time display from the broadcaster. It will remain on the screen for about 5 seconds.



9:56 and 25 seconds p.m.



Note:

If you press  while this mode is activated, this mode will be cancelled.

Teletext in Digital TV

- 1** When I-Plate indicates the presence of Teletext (TTX) in a channel, press  to view Teletext. Press  again to superimpose the Teletext over a normal broadcast picture. Press again to close Teletext and watch TV.
- 2** Press **P**^ and **P**∨ to select Teletext page. Press the **Number** buttons to input a Teletext page to view the page directly. If FASTEXT is available, simply press the relevant colored button on the remote control.
- 3** Press  to close the Teletext and watch TV.

Other Digital TV features and settings

Setting the EPG (Electronic Program guide)

- 1 Press **MENU**, then \triangleleft or \triangleright to select **PROGRAM** menu.
- 2 Press ∇ or \triangle to select **EPG** then, press **OK** to display **EPG**. Alternatively, press **GUIDE** to display EPG directly.

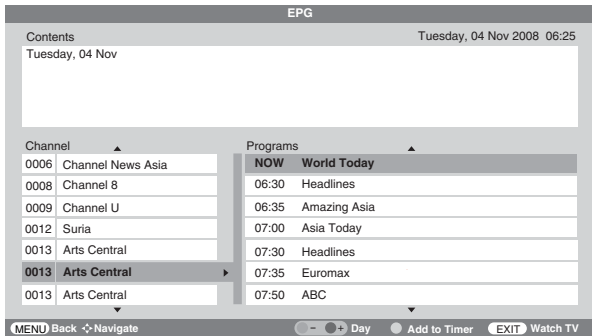

- 3 Press ∇ and \triangle to select the channel, names of the program being broadcast will appear, press \triangleright , then ∇ and \triangle to select a particular program.
- 4 When the extended program information is received for selected program, it will appear in the **Contents** box. If the selected program is also the "NOW" program, the preview window will appear to the right of the extended program information.
- 5 Press the Yellow and Blue button to change the day. Up to seven days from today can be selected.
- 6 Confirm the program, then press the Red button to display the **Timer Setting** menu. If you have locked channel or activating **Parental Rate**, enter the password when prompted.

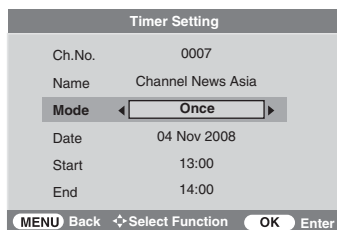

- 7 Press \triangleleft or \triangleright to change the Mode, then press **OK** to save.

Note:

Toshiba does not provide **EPG** data; therefore Toshiba is not liable for the content of such data. The data provider may elect to discontinue the service or it may cease to be (or never be) available in your area. In any of these circumstances, the **EPG** feature will not function. Toshiba is not liable in the event that this service is unavailable or for any consequences arising from customers having used or not being able to use this service.

Password

In Digital TV, channels and programs can be locked to prevent viewing of unsuitable films and programs. These can only be accessed with a password. Default password is 0000.

Setting the Password

- 1 Press **MENU**, then press \triangleleft or \triangleright to select the **SYSTEM** menu.
- 2 Press ∇ or \triangle to select **Password**, then press **OK**.



- 3 Enter your password using the **number** buttons or press 0000 (which is the default password).
- 4 Press ∇ or \triangle to select **Set Password**, then press **OK**.

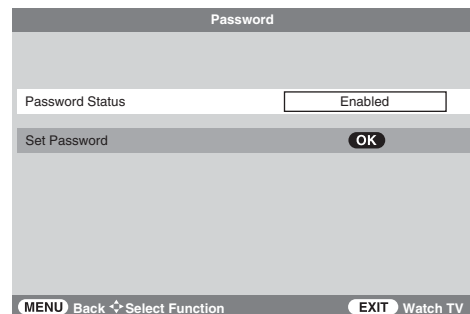

- 5 Use the Number buttons to enter 4-digit Password and enter the same 4-digit password to confirm.

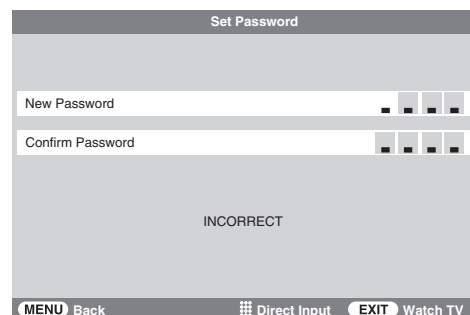

Select the Password Status

This option allows you to enable or disable the password.

- 1 From the **Password** menu, press ∇ or \triangle to select **Password Status**.
- 2 Press \triangleleft or \triangleright to select **Enabled** or **Disabled**. When status is set to **Disabled**, you will not be prompted for password for all menus and channels (except **Password** menu itself). All currently locked status and parental rate will be reset to default if you disable the password.

Parental rate

The type of program displayed on the TV can be limited based on the parental guidance codes. See Appendix for Australian parental guide code.

Setting the parental rate

- 1 Press **MENU**, then press **◀** or **▶** to select the **PROGRAM** menu.
- 2 Press **▽** or **△** to select **Parental Rate**, then press **OK**.

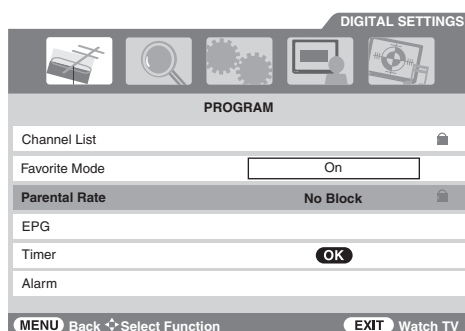

- 3 Enter password when prompted.
- 4 Press **▽** and **△** to select the suitable Rating, then press **OK** to save.

Channel list

Setting favorite, locking and skipping channels

- 1 Press **MENU**, then press **◀** or **▶** to select the **PROGRAM** menu.
- 2 Press **▽** or **△** to select **Channel List**, then press **OK**.
- 3 Enter password when prompted.

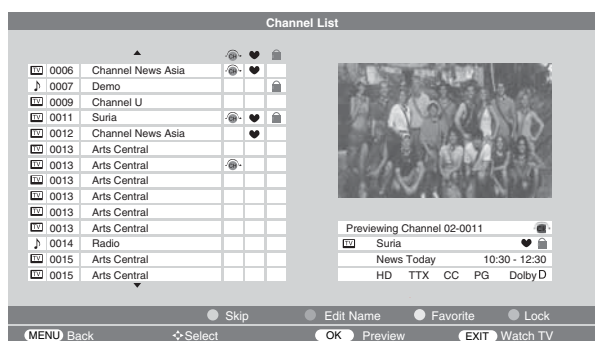

- 4 The current watching channel will be highlighted as the first entry and appear in the preview window.

- 5 Press **▽** and **△** to select channels, then press **OK** to preview the channel. When channel with **TV** is selected, you will see the video being displayed in the preview window. And when channel with **♪** is selected, preview window displays radio-graphics, along with the detailed channel information shown below the window.

- 6 Press the Yellow button to mark the channel as favorite (♥). To reset, press the Yellow button again.

Note:

When you mark one or more channels in the **Channel List** as favorites, you can turn on **Favorite Mode** in the **PROGRAM** menu.

- 7 Press the Blue button to lock (🔒) the selected channel. To reset, press the Blue button again.

Note:

When any of the locked channels is selected, the password must be entered before they can be accessed.

- 8 Press the Red button to mark the selected channel for skip (⊖). Skipped channels will not appear in the Navigation List, Favorite, EPG, Timer and Alarm.

Note:

Broadcasters may from time to time update the service information of their channels. If there is any change in the channel information or broadcasting parameters, the favorite, lock and skip status of the channels might be restored to the default setting.

Editing channel names

- 1 In **Channel List**, press **▽** or **△** to select channel, then press **OK** to preview the channel, then press the Green button to edit the name of the selected channel.

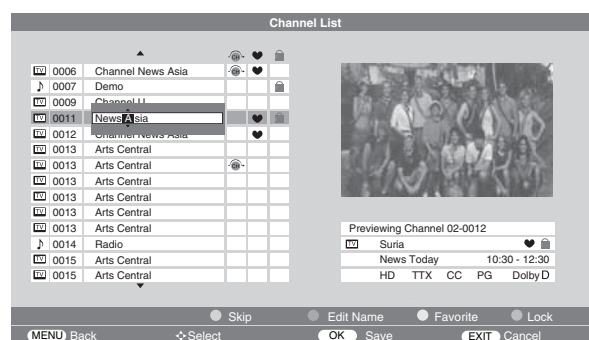

- 2 Use **▽**, **△**, **◀** and **▶** to edit the name. Press **OK** to save or **EXIT** to cancel.

Favorite Channel List

- 1 When viewing in Digital TV, press **LIST FAV** to display the **Navigation** list.
- 2 Press **LIST FAV** again to display **Favorite Channel** list.



- 3 Press ∇ and \triangle to select your favorite channel, then press **OK**.

Favorite Mode

This function enables or disables the favorite mode. When the **Favorite Mode** is set to **On**, you can change the program by using **P^** or **Pv** while you are watching TV.

- 1 From the **PROGRAM** menu, press ∇ or \triangle to select **Favorite Mode**, then press \triangleleft or \triangleright to select **On** or **Off**.

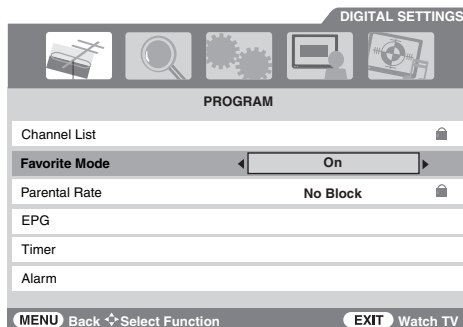

Note:

The favorite mode can only be activated if one or more channels in the Channel List are marked as favorites. Similarly, if the favorite status is removed from all the channels in the Channel List, the favorite mode is turned off automatically.

Subtitle

- 1 When **I-Plate** indicates the presence of Subtitle (CC) in a channel, press **SUBTITLE** to display the current **Subtitle** status. While this status is displayed, press again to change the setting. Subtitle On or Off can be selected.
- 2 If you switch off the TV, the **Subtitle** mode will be remembered the next time it is switch ON.

Notes :

- If **Subtitle** is ON, the TV will always display subtitle whenever such information is available in the channel you are viewing. You may use **I-Plate** to check if subtitle is currently available.
- In Australia, you may also view **Subtitle** by directly entering page 801 in Teletext. However, by doing so, the TV remains in Teletext mode and you cannot change the channels because **P^** and **Pv** will change Teletext pages rather than channels. To view subtitle, it is recommended that you turn on Subtitle mode.

Restore factory setting

This function will delete all stored digital channels and settings. The TV will return to default factory settings.

- 1 From the **SYSTEM** menu, press ∇ or \triangle to select **Restore Factory Setting**, then press **OK**.
- 2 A screen will appear prompting for password. Enter your password using the **Number** buttons or press 0000 (which is the default password).
- 3 A confirmation screen will appear indicating that **Confirm restore to factory default ?**, select **Yes** and press **OK**.

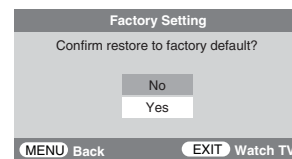

- 4 The **Welcome** screen will appear (see page 11 for the "Tuning the TV for the first time").

Audio Preference

Selecting The Audio Mode

- 1 From the **PROFILE** menu, press ∇ or \triangle to select **Audio Preference**, then press **OK**.
- 2 Press \triangleleft or \triangleright to select **Audio Mode**.

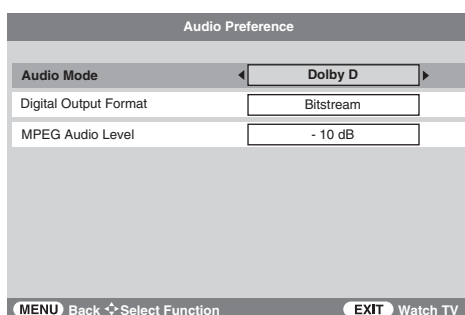

- 3 Press \triangleleft or \triangleright to select **Dolby D** or **MPEG**.
 - Dolby D:** If you select this option, the TV will select the first Dolby Digital audio track, if available. However, if the channel does not contain any Dolby Digital audio track, then the first available MPEG audio track will be selected.
 - MPEG:** If you select this option, the TV will select the first MPEG audio track, if available. However, if the channel does not contain any MPEG audio track, then the first available Dolby Digital audio track will be selected.

Digital Output Format

- 1 From the **Audio Preference**, press ∇ or \triangle to select **Digital Output Format**.
- 2 Press \triangleleft or \triangleright to select **Bitstream** or **PCM**.
 - Bitstream:** Select this when an amplifier equipped with builtin Dolby Digital or MPEG decoder is connected to this TV.
 - PCM:** Select this when a 2ch digital stereo amplifier is connected to this TV. When you select a Dolby Digital or MPEG audio track in Audio Track, the sound is converted to the PCM (2ch) format and output.

MPEG Audio Level

- 1 From **Audio Preference**, press ∇ or \triangle to select **MPEG Audio Level**.
- 2 Press \triangleleft or \triangleright to adjust the **MPEG audio level** from -10dB to 0dB. This setting will not be applicable to Dolby Digital audio.

Note:
 Manufactured under license from Dolby Laboratories. "Dolby" and the double-D symbol are trademarks of Dolby Laboratories.

Audio Track

- 1 Press **OK** to display **Audio Track** directly.
- 2 Press ∇ or \triangle to select the preferred audio track present in the program being watched, then press **OK**.

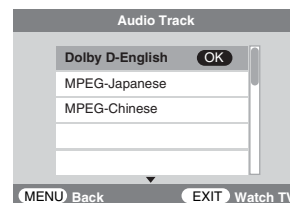

Transparency

- 1 From the **PROFILE** menu, press ∇ or \triangle to select **Transparency**.
- 2 Press \triangleleft or \triangleright to adjust the degree of On-Screen-Display transparency.

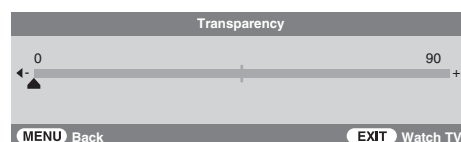

TV Setup

- 1 Press **MENU**, then press \triangleleft or \triangleright to select the **TV SETUP** menu.
- 2 Press **OK** to close **DIGITAL SETTINGS** menu and open the **TV SETUP** menu.



Connecting your TV

Back connections

Connection example

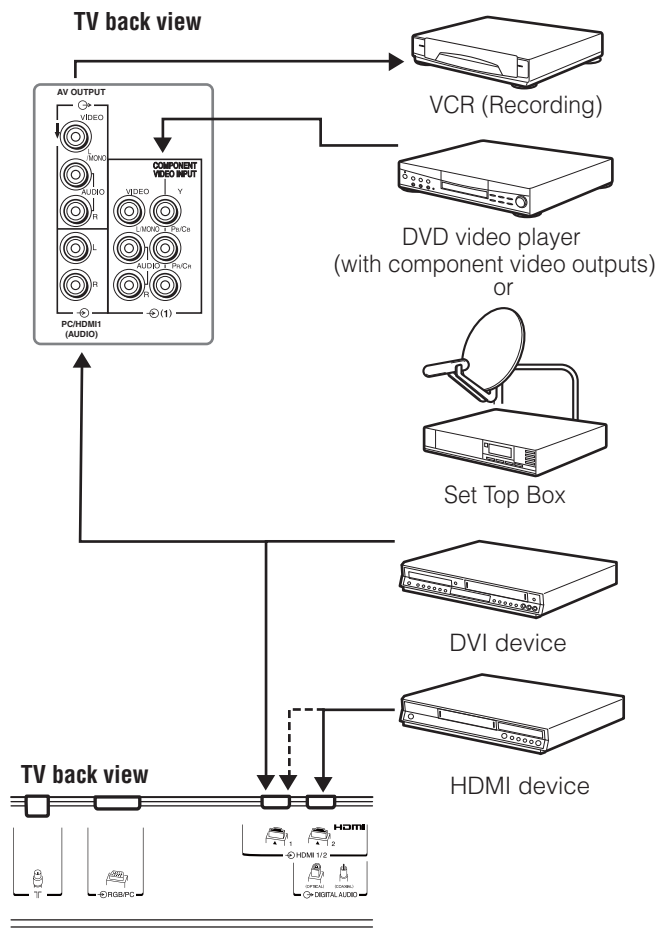

- Before connecting any external equipment, turn off all main power switches.
- The unauthorized recording of television programs, DVDs, video tapes and other materials may infringe upon the provisions of copyright law.
- If you connect both of the **COMPONENT VIDEO INPUT** terminal and **VIDEO** input terminal, the **COMPONENT VIDEO** signal will appear on the screen (display changes to 1C).
- The **COMPONENT VIDEO INPUT** consists of three component video signals (**Y, P_B/C_B, P_R/C_R**) and provides the best picture performance. These terminals can only be used with the component video compatible equipment e.g. DVD video player, etc.
- Additional equipment and cables shown are not supplied with this TV.
- If you connect mono sound equipment to **AV OUTPUT**, connect the audio input of the equipment to the **L/MONO** jack on the TV.

Connecting an audio system - digital only -

You can enjoy high quality dynamic sound by connecting the TV to an audio system.

Notes:

- **DO NOT** connect the **DIGITAL AUDIO** output terminal to the AC-3 RF input of a Dolby Digital Receiver with a built-in Dolby Digital decoder.
- Connect the **DIGITAL AUDIO** output terminal to the **OPTICAL** or **COAXIAL** input of a Receiver or Processor.
- Refer to the owner's manual of the connected equipment as well.
- When you connect the TV to other equipment, be sure to turn off the power and unplug all of the equipment from the wall outlet before making any connections.
- The output sound of the TV has a wide dynamic range. Be sure to adjust the audio amplifier's volume to a moderate listening level before turning on the power. Otherwise, the speakers and your hearing may be damaged by a sudden high volume sound.
- Turn off the amplifier before you connect or disconnect the TV's power cord. If you leave the amplifier power on, the speakers may be damaged.

Warning:

When you are connecting (via the **DIGITAL AUDIO** output terminal) an AV decoder that does not have Dolby Digital or MPEG decoding function, be sure to set **PCM** in Digital Output (page 32). Otherwise, the speakers and your hearing may be damaged by a sudden high volume sound.

Connecting an amplifier equipped with a Dolby Digital decoder

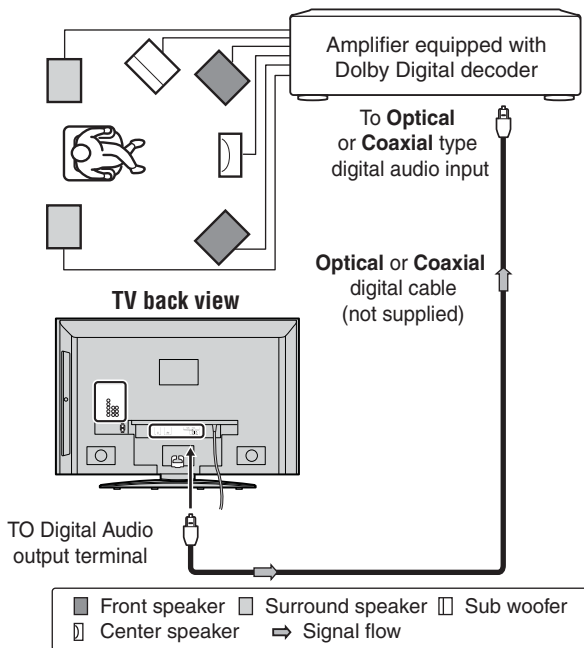

You can enjoy dynamic realistic sound by connecting the TV to an amplifier equipped with a Dolby Digital decoder or Dolby Digital processor. When using this setup, select **Bitstream** in Digital Output menu.

Connecting an amplifier equipped with an MPEG decoder

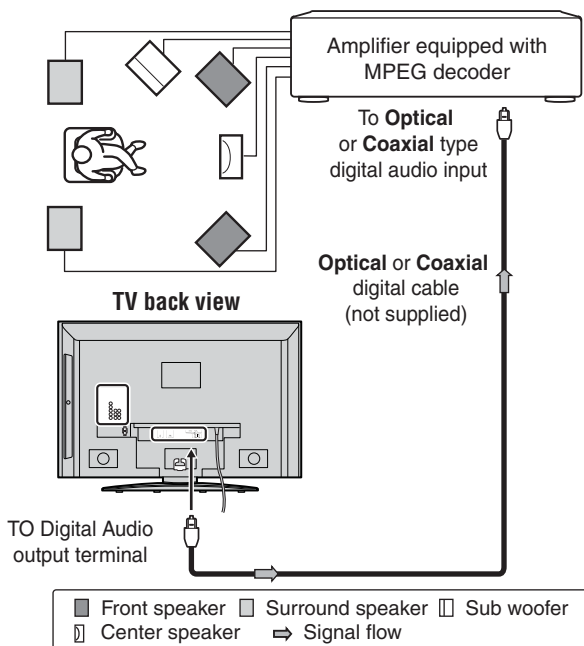

You can enjoy motion picture with dynamic realistic sound by connecting the TV to an amplifier equipped with an MPEG audio decoder or MPEG audio processor. When using this setup, select **Bitstream** in Digital Output menu.

Connecting an amplifier equipped with a digital audio (optical or coaxial) input

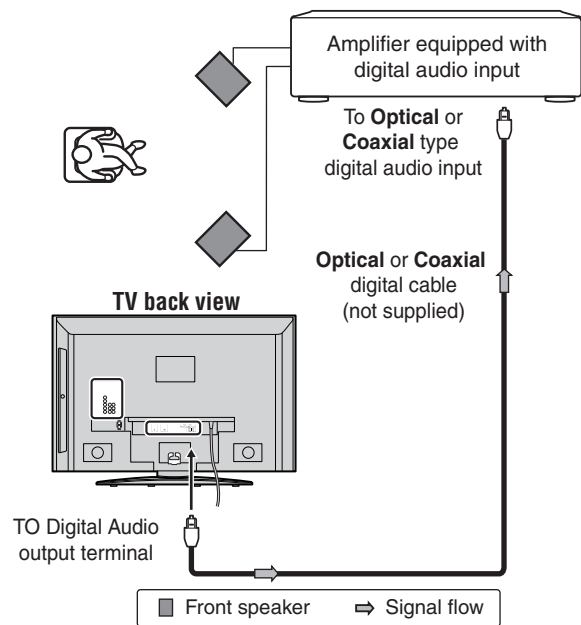

You can enjoy dynamic sound of 2-channel digital stereo by connecting the TV to an amplifier equipped with a digital audio (optical or coaxial) input and speaker system (right and left front speakers). When using this setup, select **PCM** in Digital Output menu.

Side connections





You can connect a wide variety of auxiliary equipment via the terminals located on the right side of the panel  (2).

Please always refer to the owner's manual of the equipment to be connected for full details.

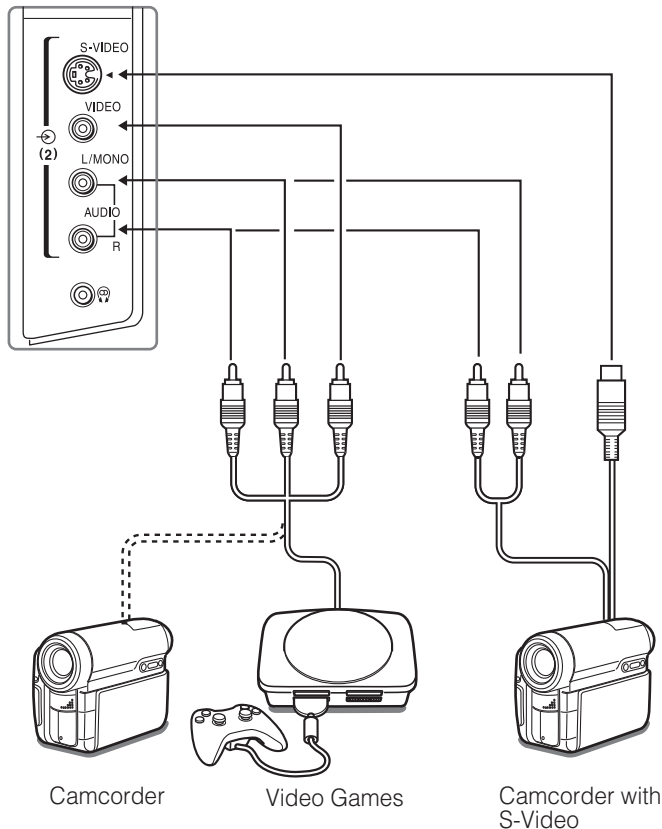
Connection example

TV right side view



- To select the side inputs, press  to display the video input mode list, then press ∇ or \triangle to select  (2) (see page 25), then press **OK**.
- Before connecting any external equipment, turn off all main power switches.
- If you connect both of the **S-VIDEO** input terminal and **VIDEO** input terminal, the **S-VIDEO** signal will appear on the screen (display changes to  2S).
- If you connect mono sound equipment to , connect the audio output of the equipment to the **L/MONO** jack on the TV.
- You can enjoy Video Games with this TV. However shooting games, where the player shoots at a target on the TV screen with a light gun, may not work because of the LCD Color TV properties.

Connecting an HDMI or a DVI device

- When turning on your electronic components, turn on the TV first, and then the HDMI or DVI device.
- When turning off your electronic components, turn off the HDMI or DVI device first, and then the TV.
- This TV may not be compatible with features and/or specifications that may be added in the future.
- This TV is only operable with L-PCM on 32/44. 1/48 kHz and 16/20/24 bits. If there is no sound when using HDMI, use the analog audio cables to connect the TV and the HDMI device, and select **Analog** in **HDMI1 audio** of the **AV connection** menu (see page 36).

Connecting an HDMI or a DVI device

The HDMI input on your TV receives digital audio and uncompressed digital video from an HDMI device or uncompressed digital video from a DVI device.

This input is designed to accept HDCP program material in digital from EIA/CEA-861/861B compliant consumer electronic devices (such as a set top box or DVD player with HDMI or DVI output).

The HDMI input is designed for best performance with 1080i (50 Hz/60 Hz), 1080p (50Hz/60Hz) high-definition video signals, but will also accept and display 480i, 480p, 576i, 576p, 720p (50 Hz/60 Hz (60Hz: except for the E-EDID)) and VGA signals.

- **HDMI**: High-Definition Multimedia Interface
- **DVI**: Digital Video Interface
- **HDCP**: High-bandwidth Digital Content Protection
- EIA/CEA-861/861B compliance covers the transmission of uncompressed digital video with high-bandwidth digital content protection, which is being standardized for reception of high-definition video signals. Because this is an evolving technology, it is possible that some devices may not operate properly with the TV.
- **E-EDID**: Enhanced-Extended Display Identification
- **VGA**: VESA 640 × 480 @ 60 Hz
- **L-PCM**: Linear-Pulse Code Modulation

Connecting an HDMI device

One HDMI cable (type A connector)

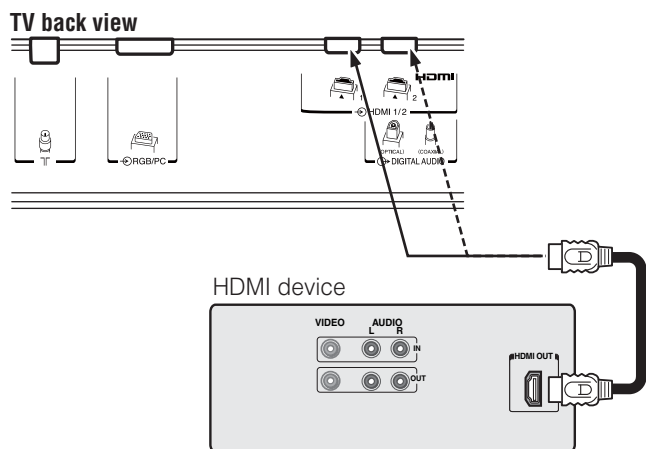

For proper operation, it is recommended that you use a short HDMI cable.

HDMI cable transfers both video and audio.

Note:

It is possible that some HDMI device may not operate properly with this TV.

Connecting a DVI device

One HDMI (type A connector)-to-DVI adapter cable and audio cables

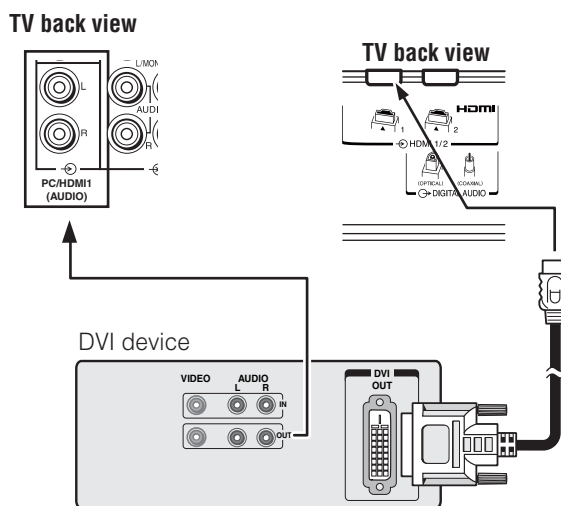

HDMI (type A connector)-to-DVI adapter cable

For proper operation, the length of an HDMI-to-DVI adapter cable should not exceed 3m. The recommended length is 2m.

Standard analog audio cables

An HDMI-to-DVI adapter cable transfers only video. Separate analog audio cables are required.

Note:

HDMI, the HDMI logo, and High-Definition Multimedia Interface are trademarks or registered trademarks of HDMI Licensing, LLC.

Selecting the PC/HDMI1 audio mode

You can select PC audio or HDMI1 audio when using this function (page 35).

- 1 Press **MENU**, then press **◀** or **▶** to display the **SET UP** menu.
- 2 Press **▽** or **△** to select **AV connection**, then press **OK** to display the **AV connection** menu.

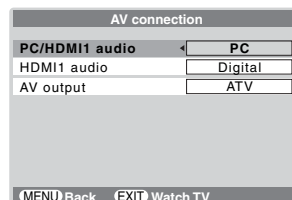

- 3 Press **▽** or **△** to select **PC/HDMI1 audio**, then press **◀** or **▶** to select **PC** or **HDMI1**.

Setting the HDMI1 audio mode

You can select sound of an HDMI or DVI device connected to the HDMI1 input terminals (page 35) from three modes: **Auto**, **Digital** or **Analog**.

Note:

This function is available only when the PC/HDMI1 audio mode is set to **HDMI1**.

- 1 From the **AV connection** menu, press **▽** or **△** to select **HDMI1 audio**.

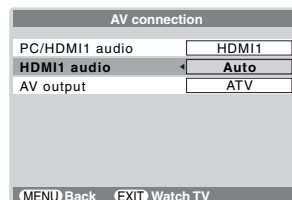

- 2 Press **◀** or **▶** to select **Auto**, **Digital** or **Analog**.

When the sound is not audible:

If no sound comes out while receiving HDMI signal, the sound may be audible when using this function set to off.

- 1 From the **HDMI1 audio** item in the **AV connection**, press and hold **OK** until the **Lip Sync Latency** menu appears on the screen.



- 2 Press **◀** or **▶** to select **Off**.
- 3 Press **⏻** on the remote control or **⏻** on the TV right side panel to switch to the standby mode.
- 4 Press **⏻** on the remote control or **⏻** on the TV right side panel again to switch the power on.

Note:

Depending on some external equipment, the sound may be audible by turning it off and on again.

Selecting the AV output mode

You can select the AV output from three modes; **ATV**, **DTV** or **Monitor**.

- From **AV Connection** menu, press ∇ or \triangle to select **AV Output**.

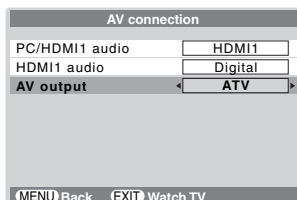

- Press \triangleleft or \triangleright to select the desired output mode.

ATV: Selected programmed channel from Analog TV system is output from the **AV OUTPUT** terminal.

DTV: Selected programmed channel from Digital TV system is output from the **AV OUTPUT** terminal.

Monitor: The AV output depends on the selected video input mode.
(e.g. If ① is selected (page 25), the AV signal input to ① is output from the **AV OUTPUT** terminal.

Note:

When it is set to **Monitor** (and in DTV mode) or **DTV**, and the digital program is locked, the output will be blank and audio will be muted.

Connecting a computer

To connect a PC to the RGB/PC terminal on the TV:

An analog RGB (15 pin) computer cable can be connected.

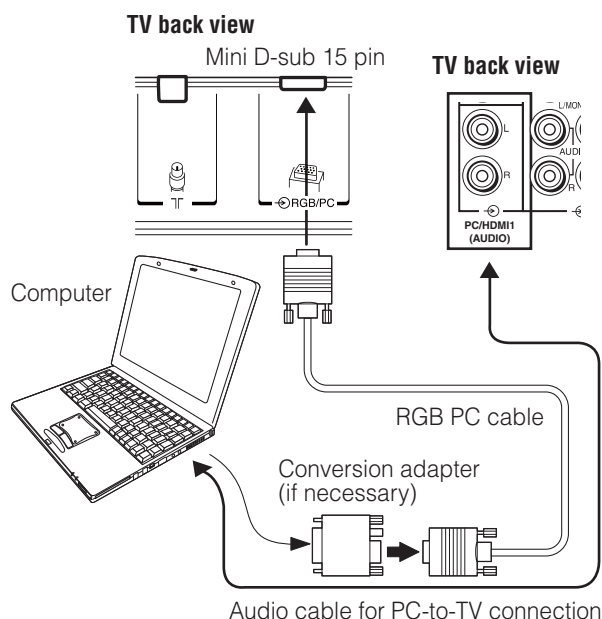

Connect a PC cable from the computer to the ② **RGB/PC** terminal on the back of the TV.

The following signals can be displayed:

- VGA: VESA 640 × 480 @ 60/75 Hz
- SVGA: VESA 800 × 600 @ 60/75 Hz
- XGA: VESA 1024 × 768 @ 60/70/75 Hz
- W-XGA: VESA 1280 × 768 @ 60/75 Hz
- W-XGA: VESA 1360 × 768 @ 60 Hz
- S-XGA: VESA 1280 × 1024 @ 60/75 Hz

However, these signal formats are converted to match the number of pixels of the LCD panel.

Therefore, the TV may not display small text properly.

Notes:

- Some PC models cannot be connected to this TV.
- There is no need to use an adapter for computers with DOS/V compatible mini D-sub 15 pin terminal.
- A bar may appear in the upper, lower, right or left side of the screen, or parts of the picture may be obscured depending on some signals. This is not the malfunction.
- If the edges of the picture are stretched, readjust the picture position adjustments in the **PC Setting** menu.
- Depending on the specification of the PC you are playing the DVD-Video on, and the DVD's title, some scenes may be skipped, or you may not be able to pause during multi-angle scenes.
- If connecting a certain PC model that signal is particular, the PC signal may not be detected correctly.

Signal names for mini D-sub 15 pin connector

Pin assignment for RGB/PC terminal

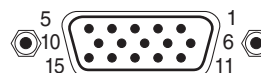

Pin No.	Signal name	Pin No.	Signal name
1	R	9	NC
2	G	10	Ground
3	B	11	NC
4	NC (not connected)	12	NC
5	NC	13	H-sync
6	Ground	14	V-sync
7	Ground	15	NC
8	Ground		

To connect a PC to the HDMI terminal on the TV:

When connecting a PC to the HDMI terminal on the TV, use an HDMI-to-DVI adapter cable and analog audio cables.

If connecting a PC with an HDMI terminal, use an HDMI cable (type A connector). Separate analog cables are not necessary.

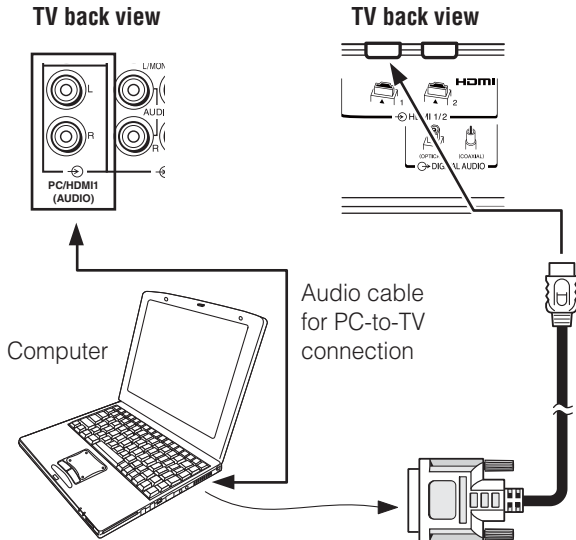

The HDMI input can accept and display VGA, 480i, 480p, 576i, 576p, 720p (50Hz/60Hz (60Hz: except for the E-EDID)), 1080i, and 1080p signal formats.

Notes:

- The edges of the images may be hidden.
- If receiving a 720p, 1080i, or 1080p signal program, PC mode scales the video to display the entire picture within the borders of the screen (e.g. no overscanning) (page 18).

Using the PC setting

- In the PC input mode, you cannot select the **3D color management** and **Base color adjustment** in the **PICTURE** menu and the **Color**, **Tint**, **Sharpness**, **Black stretch**, **MPEG NR** and **DNR** in the **Picture setting** menu and **Cinema mode** (page 21).
- In the PC input mode, the **Manual setting** (page 26) is not displayed.
- First press \odot to display the video input mode list, then press ∇ or \triangle and \odot in order to select the PC input mode (page 25).
- This function may not be available for some signal or if no signal is received.
- The optimum points of the clock phase and sampling clock adjustments may be incomprehensible according to the input signals.

Adjusting the picture size/position

- 1 Press MENU , then press \triangleleft or \triangleright to display the **SET UP** menu.

- 2 Press ∇ or \triangle to select **PC Setting**.

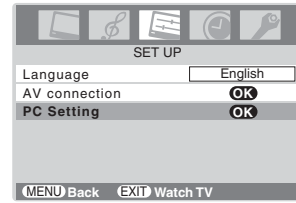

- 3 Press \odot to display the **PC Setting** menu.

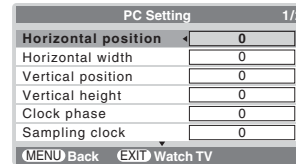

- 4 Press ∇ or \triangle to select an option you want to adjust. Press \triangleleft or \triangleright to adjust the settings as required.



Adjusting the clock phase of the picture

If the clock phase, which synchronizes the PC signal and LCD display, is not optimized, the picture will blur.

This function enables you to adjust clock phase and display a clear picture.

- 1 From the **PC Setting** menu, press ∇ or \triangle to select **Clock phase**.
- 2 Press \triangleleft or \triangleright to obtain a clear picture.



Adjusting the sampling clock

If the sampling clock does not match with the dot clock frequency of the PC, blurred picture detail will occur, or screen width will change, or drift patterns in vertical lines may be apparent.

This function enables you to adjust it and optimize the picture.

- 1 From the **PC Setting** menu, press ∇ or \triangle to select **Sampling clock**.
- 2 Press \triangleleft or \triangleright to optimize the picture.



Resetting the PC setting

The Reset function adjusts the PC Setting to the factory settings.

- 1 From the **PC Setting** menu, press ∇ or \triangle to select **Reset** on the 2nd page.

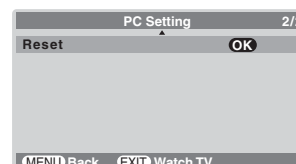



- 2 Press \odot .

Troubleshooting

Before calling a service technician, please check the following table for a possible cause of the symptom and some solutions.

Symptom and solution



TV will not turn on

- Make sure the power cord is plugged in, then press  or .
- The remote control batteries may be dead. Replace the batteries.

No picture, no sound

- Check the antenna connections.

No sound, picture OK

- The sound may be muted. Press ,  or .
- The station may have broadcast difficulties. Try another channel.

Poor sound, picture OK

- The station may have broadcast difficulties. Try another channel.

Poor picture, sound OK

- Check the antenna connections.
- The station may have broadcast difficulties. Try another channel.
- Adjust the **PICTURE** menu.

Poor reception of broadcast channels

- Check the antenna connections.
- The station may have broadcast difficulties. Try another channel.
- Make sure the Color system is properly set.

Teletext problems

- Check the antenna connections.
Good performance of text depends on a good strong broadcast signal.

Multiple images

- The station may have broadcast difficulties. Try another channel.
- Antenna reception may be poor. Use a high directional outdoor antenna.
- Check if the direction of the antenna has changed.

Poor color or no color

- The station may have broadcast difficulties. Try another channel.
- Adjust the **Tint** and/or **Color** in the **PICTURE** menu.

The remote control does not operate

- Remove all obstructions between the remote control and the remote control sensor on the TV.
- The remote control batteries may be dead. Replace them with new ones.
- Check that the TV/STB/DVD switch on the remote control is properly set.

Some pixels of the screen do not light up

- The LCD display panel is manufactured using an extremely high level of precision technology, however, sometimes some pixels of the screen may be missing picture elements or have luminous spots. This is not a sign of a malfunction.

The picture brightness varies when you switch the TV on.

- If you switch the TV on at 0°C and under, wait until the warms up.

The brightness of the screen comes down, or flickers of the screen are caused, or some parts of the screen do not light up.

- When you just buy and start to use this TV, a flickering may be caused in the screen. In this case, switch off the TV, then switch on it again to cure the condition.
- The cold cathode fluorescent lamp used for the back light on this TV has longevity. When the brightness of the screen comes down, or the flickers of the screen are caused, or some parts of the screen do not light up, it may reach the end of its life. Contact a service technician.

Symptom and solution - digital only -



Poor picture

- Check the antenna connections. Make sure it is aligned to the correct broadcast direction.
- Check the signal level and quality in the **Manual Scan** menu.
- If you use any kind of amplifier to boost the signal level, check whether it works well, and ask for help from the antenna installer.

No picture

- Use the **Manual Scan** menu to rescan this channel.
- Try another channel.
- Reduce **RF** amplifier gain if connected to **RF** booster.

No sound from DIGITAL AUDIO

- The sound may be muted. Press ,  or .
- Make sure the TV is adjusted to the correct **Audio Track**.
- Use the **Manual Scan** menu to rescan this channel.
- Try another channel.

Not all channels are available after using the Auto Scan when tuning the TV for the first time.

- This symptom is caused by unexpected frequency offset.
- Using the **Manual Scan** menu to scan for the missing channels. Once the TV picks up the signal, all the transmission parameters will be stored in the internal memory.

Cannot lock signal by using Manual Scan

- Check the frequency that you have entered is exactly the Middle frequency of the wanted channel.
- Refer to the solutions for "Poor picture".

No Teletext, no Subtitle

- Make sure the channel that you are watching carries Teletext/Subtitle information from **I-Plate**.

Cannot receive channels after moving the TV between cities (e.g. from Melbourne to Sydney)

- Refer to page 11 to reset data.

Weak signal appears on one channel but not the other, but these channels have the same logical number

- Please make sure that you do not keep duplicate channels (i.e. channels with the same logical channel number but different physical numbers, see page 13). If you do, please delete the duplicate ones and keep only one channel with the best signal strength.

Program Timer and/or Alarm do not operate properly.

- Check the antenna connections.
- Weak signal may cause inaccurate time information.

Forget Password

- Please contact to the local dealer.

APPENDIX

AUSTRALIAN PARENTAL GUIDANCE CODES (Normative)

Recommended On-Screen-Display for parental guidance codes transmitted within DVB-SI EIT information using the DVB parental_rating_descriptor.

			Receiver Menu Set-up and Suggested OSD wording for Setting Blocking (Restriction of access)							
			Block All	Block G and above (optional)	Block PG and above	Block M and above	Block MA and above	Block AV and above	Block R and above	No Block
Transmitted rating hex code	Australian parental guide code	On-Screen-Display	Resultant receiver action to received hex code ✓ is show program - ✗ is block until PIN entered							
0 × 00	Not Classified	–	✗	✓	✓	✓	✓	✓	✓	✓
0 × 01		–	✗	✓	✓	✓	✓	✓	✓	✓
0 × 02	P Pre school	P	✗	✓	✓	✓	✓	✓	✓	✓
0 × 03		P	✗	✓	✓	✓	✓	✓	✓	✓
0 × 04	C Children's	C	✗	✓	✓	✓	✓	✓	✓	✓
0 × 05		C	✗	✓	✓	✓	✓	✓	✓	✓
0 × 06	G General	G	✗	✗	✓	✓	✓	✓	✓	✓
0 × 07		G	✗	✗	✓	✓	✓	✓	✓	✓
0 × 08	PG Parental Guidance Recommended	PG	✗	✗	✗	✓	✓	✓	✓	✓
0 × 09		PG	✗	✗	✗	✓	✓	✓	✓	✓
0 × 0A	M Mature Audience 15+	M	✗	✗	✗	✗	✓	✓	✓	✓
0 × 0B		M	✗	✗	✗	✗	✓	✓	✓	✓
0 × 0C	MA Mature Adult Audience 15+	MA	✗	✗	✗	✗	✗	✓	✓	✓
0 × 0D		MA	✗	✗	✗	✗	✗	✓	✓	✓
0 × 0E	AV Adult Audience, Strong violence 15+	AV	✗	✗	✗	✗	✗	✗	✓	✓
0 × 0F	R Restricted 18+	R	✗	✗	✗	✗	✗	✗	✗	✓

Broadcast system

Broadcast transmission systems of each country or region

Asia M.E.

Country or region	Color	Sound
Bahrain, Kuwait, Israel, Oman, Qatar, United Arab Emirates, Yemen, etc. Indonesia, Malaysia, Singapore, Thailand, etc.	PAL	B/G
China	PAL	D/K
China Hong Kong	PAL	I
Iraq, Islamic Republic of Iran, Lebanon, Saudi Arabia, etc.	SECAM	B/G
Russian Federation, etc.	SECAM	D/K
Myanmar, etc.	NTSC	M

Oceania

Country or region	Color	Sound
Australia, New Zealand, etc.	PAL	B/G

Africa

Country or region	Color	Sound
Republic of South Africa, etc.	PAL	I

South America

Country or region	Color	Sound
Argentina, Paraguay, Uruguay, etc.	PAL	N
Brazil	PAL	M
Chile, Colombia, etc.	NTSC	M

Note:

PAL, SECAM and NTSC 3.58 (MHz) are different color signal broadcast transmission systems applicable to different countries or region. NTSC 4.43 (MHz) is used in special VCRs to playback NTSC recorded video tapes through PAL television equipment.

Specifications

Integrated Digital LCD TV

Model

37X3000A, 42X3000A, 46X3000A, 52X3000A

Power source

220 V-240 V AC, 50 Hz

Power consumption

37X3000A: 188 W, <1.0 W (standby)
 42X3000A: 269 W, <1.0 W (standby)
 46X3000A: 304 W, <1.0 W (standby)
 52X3000A: 344 W, <1.0 W (standby)

Dimensions

37X3000A: 916 mm (W) 637 mm (H) 298 mm (D)
 42X3000A: 1020 mm (W) 699 mm (H) 352 mm (D)
 46X3000A: 1132 mm (W) 763 mm (H) 352 mm (D)
 52X3000A: 1280 mm (W) 847 mm (H) 390 mm (D)

Mass (Weight)

37X3000A: 22.8 kg
 42X3000A: 30.0 kg
 46X3000A: 35.1 kg
 52X3000A: 44.7 kg

Analog TV system (Antenna input)

Channel coverage:

PAL	B/G	(CCIR)	VHF	2 - 12
			UHF	21 - 69
			CATV	X - Z+2, S1 - S41
PAL	I	(UK)	VHF	-
			UHF	21 - 69
			CATV	-
PAL	D/K	(CHINA)	VHF	1 - 12
			UHF	13 - 57
			CATV	Z1 - Z38
SECAM	B/G	(CCIR)	VHF	2 - 12
			UHF	21 - 69
			CATV	X - Z+2, S1 - S41
SECAM	D/K	(OIRT)	VHF	1 - 12
			UHF	21 - 69
			CATV	X1 - X19
NTSC	M	(US)	VHF	2 - 13
			UHF	14 - 69
			CATV	A6 - A1, A - W, AA - ZZ, AAA, BBB
NTSC	M	(JAPAN)	VHF	1 - 12
			UHF	13 - 62
			CATV	M1 - M10, S1 - S41

Special RF signal:

NTSC 4.43 color system 5.5/6.0/6.5 MHz sound system
 PAL 60 Hz color system 5.5/6.0/6.5 MHz sound system

Digital TV System

Compliant Standard	DVB-T
Video Decoding	MP @ ML & MP @ HL
Audio Decoding	Dolby® Digital, MPEG (I & II)
Audio Sampling Rate	32, 44.1, 48 kHz

Digital TV Terrestrial Tuner / Demodulator

Frequency	51~858 MHz
Loop Through	51~858 MHz
Bandwidth	6, 7, 8 MHz
Demodulator	COFDM
FFT Mode	2K, 8K
Constellation	QPSK, 16QAM, 64 QAM
Guard Interval	1/4, 1/8, 1/16, 1/32
Inner Coding Rate	1/2, 2/3, 3/4, 5/6, 7/8

COMPONENT VIDEO INPUT terminals (the signal format)

480i, 480p, 576i, 576p, 720p (50/60 Hz), 1080i (50/60 Hz)
 (These signal formats are converted to match the number of pixels of the LCD panel.)

Color system (analog TV system)

PAL, SECAM, NTSC 3.58/4.43

Aspect ratio

16 : 9

Visible size (diagonal)

37X3000A: 94.0 cm
 42X3000A: 106.7 cm
 46X3000A: 116.8 cm
 52X3000A: 132.1 cm

Number of pixels

37X3000A, 42X3000A, 46X3000A, 52X3000A:
 1,920 (H) dots × 1,080 (V) dots

Audio power

10 W + 10 W (10 % THD)

Speakers

Main: Ø 100 mm 2 pcs.

Input/Output terminals

⊖ (1)	Input	
	Component video	Y, P _B /C _B , P _R /C _R
	Phono jacks	A/V
⊖ (2)	Input	
	4 pin	S-video
	Phono jacks	A/V
⊕ AV OUTPUT	Output	
	Phono jacks	A/V
⊖ RGB/PC	Input	
	Mini D-sub 15 pin	Analog RGB
⊖ PC/HDMI1 (AUDIO)	Input	
	Phono jacks	Audio L+R
⊖ HDMI1	Input(type A)	
	19 pin	A/V Digital
⊖ HDMI2	Input(type A)	
	19 pin	A/V Digital
⊕ Digital Audio (optical + coaxial)	Output	
	Bitstream/PCM	
Headphone jack	3.5 mm (Diameter) stereo	

Operating condition

Temperature 0 °C - 35 °C
 Humidity 20 % - 80 % (No moisture condensation)

Supplied accessories

Owner's manual (1), Remote control (1), Batteries (2),
 Clip (1)



This is used to fix the TV to a wall, pillar, etc. (see page 4).

- Design and specifications are subject to change without notice.
- Never service or remodel the TV by yourself. It may expose you to a fire hazard or dangerous voltages.

Note

TOSHIBA CORPORATION