

# SHARP®

MODEL

## LC-32AX3X

## LC-37AX3X

LCD COLOUR TELEVISION

OPERATION MANUAL

# AQUOS



**HDMI™**  
HIGH-DEFINITION MULTIMEDIA INTERFACE

# LC-32AX3X LC-37AX3X

## LCD COLOUR TELEVISION

### OPERATION MANUAL

## Contents

<b>Contents</b> .....	<b>1</b>	AV mode selection .....	25
<b>Trademarks</b> .....	<b>2</b>	OPC (Optical Picture Control) setting .....	25
<b>Dear SHARP customer</b> .....	<b>3</b>	Picture adjustments .....	26
<b>Important Safety Precautions</b> .....	<b>3</b>	Advanced .....	27
<b>Supplied accessories</b> .....	<b>5</b>	Colour temperature .....	27
<b>Preparation</b> .....	<b>6</b>	Black .....	27
Inserting the batteries .....	6	3D-Y/C .....	27
Using the remote control unit .....	6	Monochrome .....	28
Cautions regarding remote control unit .....	6	Film mode .....	28
Setting the TV .....	7	I/P setting .....	28
Protection against overturning .....	8	AV mode selection .....	28
Basic connection .....	9	Audio adjustment .....	28
Connecting to an antenna .....	9	Surround .....	29
Connecting to the power outlet .....	9	Power control .....	29
Setting the TV on the wall .....	10		
Removing the stand .....	10		
<b>Part names</b> .....	<b>11</b>		
TV (Front) .....	11		
TV (Rear) .....	12		
Remote control unit .....	13		
<b>Watching TV</b> .....	<b>14</b>		
Turning on the power .....	14		
Turning off the power .....	14		
Simple button operations for changing channels .....	15		
Using Flashback (\$) on the remote control unit .....	15		
Using MPX on the remote control unit .....	16		
Simple button operation for changing volume/sound .....	17		
Sleep timer .....	17		
Still image .....	17		
<b>Basic adjustment settings</b> .....	<b>18</b>		
Menu operation buttons .....	18		
On-Screen Display .....	18		
Menu items .....	19		
Auto installation .....	20		
Programme setup .....	20		
Auto search .....	20		
Manual setting for each channel .....	21		
Search tuning .....	21		
Fine tuning .....	21		
Colour system .....	22		
Sound system (Broadcasting system) .....	22		
Labelling channels .....	22		
Skipping channels .....	23		
Setting the child lock .....	23		
Password setting for child lock (for TV input mode) See page 30.			
Sort .....	23		
Erase Programme .....	24		

## Contents

---

<b>Useful adjustment settings</b> .....	<b>30</b>
Password setting for child lock (for TV input mode) .....	30
Input Label .....	31
Image position .....	31
Wide Screen Signalling (WSS) .....	32
Picture aspect ratio .....	32
WIDE mode .....	33
Rotate .....	34
Language setting for on-screen display .....	34
Audio Only .....	35
DNR (Digital Noise Reduction) .....	35
HDMI Setup .....	35
Input Select .....	36
Quick Shoot .....	36
Colour system setting .....	37
Demo .....	37
<b>Useful features</b> .....	<b>38</b>
Teletext language setting .....	38
Teletext function .....	39
<b>Using external equipment</b> .....	<b>41</b>
Displaying an external equipment image .....	41
Displaying a DVD image (Example) .....	41
Connecting a VCR .....	41
Connecting a DVD player .....	42
Connecting a game console or camcorder .....	42
Connecting an HDTV tuner .....	43
<b>Appendix</b> .....	<b>44</b>
Troubleshooting .....	44
Specifications .....	45
Optional accessory .....	45
<b>Dimensional drawings</b> .....	<b>46</b>

## Trademarks

---

- “HDMI, the HDMI logo and High-Definition Multimedia Interface are trademarks or registered trademarks of HDMI Licensing LLC.”

# Dear SHARP customer

---

Thank you for your purchase of the SHARP LCD colour TV product. To ensure safety and many years of trouble-free operation of your product, please read the Important Safety Precautions carefully before using this product.

## Important Safety Precautions

---

Electricity is used to perform many useful functions, but it can also cause personal injuries and property damage if improperly handled. This product has been engineered and manufactured with the highest priority on safety. However, improper use can result in electric shock and/or fire. In order to prevent potential danger, please observe the following instructions when installing, operating and cleaning the product. To ensure your safety and prolong the service life of your LCD colour TV product, please read the following precautions carefully before using the product.

1. Read instructions—All operating instructions must be read and understood before the product is operated.
2. Keep this manual in a safe place—These safety and operating instructions must be kept in a safe place for future reference.
3. Observe warnings—All warnings on the product and in the instructions must be observed closely.
4. Follow instructions—All operating instructions must be followed.
5. Attachments—Do not use attachments not recommended by the manufacturer. Use of inadequate attachments can result in accidents.
6. Power source—This product must operate on a power source specified on the specification label. If you are not sure of the type of power supply used in your home, consult your dealer or local power company.
7. AC cord protection—The AC cords must be routed properly to prevent people from stepping on them or objects from resting on them. Check the cords at the plugs and product.
8. Overloading—Do not overload AC outlets or extension cords. Overloading can cause fire or electric shock.
9. Entering of objects and liquids—Never insert an object into the product through vents or openings. High voltage flows in the product, and inserting an object can cause electric shock and/or short internal parts. For the same reason, do not spill water or liquid on the product.
10. Servicing—Do not attempt to service the product yourself. Removing covers can expose you to high voltage and other dangerous conditions. Request a qualified service person to perform servicing.
11. Repair—If any of the following conditions occurs, unplug the AC cord from the AC outlet, and request a qualified service person to perform repairs.
  - a. When the AC cord or plug is damaged.
  - b. When a liquid was spilled on the product or when objects have fallen into the product.
  - c. When the product has been exposed to rain or water.
  - d. When the product does not operate properly as described in the operating instructions.  
Do not touch the controls other than those described in the operating instructions. Improper adjustment of controls not described in the instructions can cause damage, which often requires extensive adjustment work by a qualified technician.
  - e. When the product has been dropped or damaged.
  - f. When the product displays an abnormal condition. Any noticeable abnormality in the product indicates that the product needs servicing.
12. Replacement parts—In case the product needs replacement parts, make sure that the service person uses replacement parts specified by the manufacturer, or those with the same characteristics and performance as the original parts. Use of unauthorized parts can result in fire, electric shock and/or other danger.
13. Safety checks—Upon completion of service or repair work, request the service technician to perform safety checks to ensure that the product is in proper operating condition.
14. Wall or ceiling mounting—When mounting the product on a wall or ceiling, be sure to install the product according to the method recommended by the manufacturer.

## Important Safety Precautions

- **Cleaning**—Unplug the AC cord from the AC outlet before cleaning the product. Use a damp cloth to clean the product. Do not use liquid cleaners or aerosol cleaners.

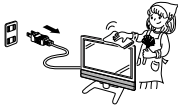

- **Water and moisture**—Do not use the product near water, such as bathtub, washbasin, kitchen sink, laundry tub, swimming pool and in a wet basement.



- Do not place vases or any other water-filled containers on this product. The water may spill onto the product causing fire or electric shock.

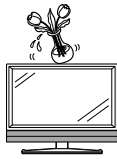

- **Stand**—Do not place the product on an unstable cart, stand, tripod or table. Doing so can cause the product to fall, resulting in serious personal injuries as well as damage to the product. Use only a cart, stand, tripod, bracket or table recommended by the manufacturer or sold with the product. When mounting the product on a wall, be sure to follow the manufacturer's instructions. Use only the mounting hardware recommended by the manufacturer.



- When relocating the product placed on a cart, it must be moved with utmost care. Sudden stops, excessive force and uneven floor surface can cause the product to fall from the cart.



- **Ventilation**—The vents and other openings in the cabinet are designed for ventilation. Do not cover or block these vents and openings since insufficient ventilation can cause overheating and/or shorten the life of the product. Do not place the product on a bed, sofa, rug or other similar surface, since they can block ventilation openings. This product is not designed for built-in installation; do not place the product in an enclosed place such as a bookcase or rack, unless proper ventilation is provided or the manufacturer's instructions are followed.

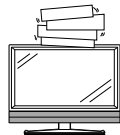

- The LCD panel used in this product is made of glass. Therefore, it can break when the product is struck forcefully or with a sharp object. If the LCD panel is broken, be careful not to be injured by broken glass.



- **Heat sources**—Keep the product away from heat sources such as radiators, heaters, stoves and other heat-generating products (including amplifiers).



- To prevent fire, never place any type of candle or naked flames on the top or near the TV set.

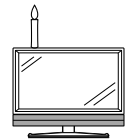

- To prevent fire or shock hazard, do not place the AC power cord under the TV set or other heavy items.



- Do not place heavy objects on this product or stand on it. Doing so could cause injury if the product overturns. Take special care near children and pets.

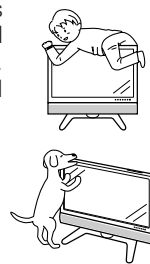

The LCD panel is a very high technology product with 3,147,264 thin film transistors, giving you fine picture details. Due to the very large number of pixels, occasionally a few non-active pixels may appear on the screen as a fixed point of blue, green or red. This is within product specifications and does not constitute a fault.

### Precautions when transporting the TV

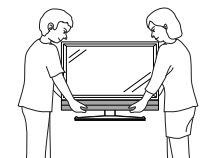

When transporting the TV, never carry it by holding onto the speakers. Be sure to always carry the TV by two people holding it with two hands—one hand on each side of the TV.



- Do not display a still picture for a long time, as this could cause an afterimage to remain.

# Supplied accessories

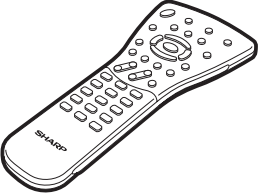
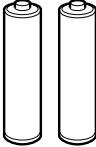
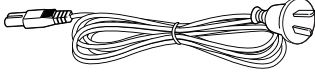
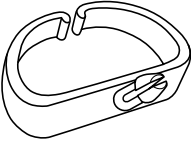
Make sure the following accessories are provided with the product.

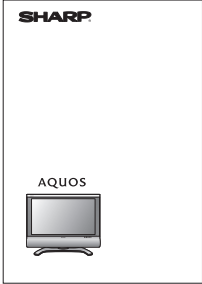
Remote control unit	“AAA” size battery (× 2)	AC cord
 <p data-bbox="309 707 400 739">Page 13</p>	 <p data-bbox="756 707 836 739">Page 6</p>	 <p data-bbox="1190 707 1270 739">Page 7</p>
Cable clamp	Safety restraints	
 <p data-bbox="316 1182 395 1214">Page 7</p>	 <p data-bbox="676 1048 799 1099">Restraining band</p> <p data-bbox="863 1048 954 1099">Screw for band</p> <p data-bbox="1086 1048 1177 1077">Clamps</p> <p data-bbox="1270 1048 1393 1099">Screws for clamps</p> <p data-bbox="970 1182 1050 1214">Page 8</p>	
Operation manual		
		

**NOTE**

- Always use the AC cord supplied with the TV.
- The illustrations and on-screen displays in this operation manual are for explanation purposes and may vary slightly from the actual operations.
- The examples used throughout this manual are based on LC-32AX3X.

# Preparation

## Inserting the batteries

Before using the TV for the first time, insert two “AAA” size batteries (supplied). When the batteries become depleted and the remote control fails to operate, replace the batteries with new “AAA” size batteries.

**1** Open the battery cover.

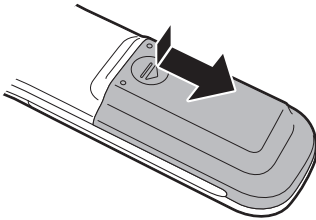

**2** Insert two supplied “AAA” size batteries.

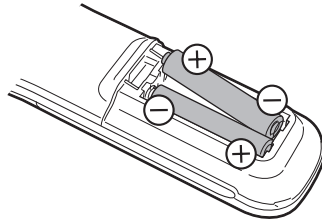

**3** Close the battery cover.

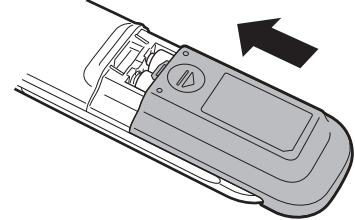

- Place batteries with their terminals corresponding to the (+) and (-) indications in the battery compartment.

## CAUTION

Improper use of batteries can result in chemical leakage or explosion. Be sure to follow the instructions below.

- Do not mix batteries of different types. Different types of batteries have different characteristics.
- Do not mix old and new batteries. Mixing old and new batteries can shorten the life of new batteries or cause chemical leakage in old batteries.
- Remove batteries as soon as they have worn out. Chemicals that leak from batteries can cause a rash. If you find any chemical leakage, wipe thoroughly with a cloth.
- The batteries supplied with this product may have a shorter life expectancy due to storage conditions.
- If you will not be using the remote control unit for an extended period of time, remove the batteries from it.

## Using the remote control unit

Use the remote control unit by pointing it towards the remote sensor window.

Objects between the remote control unit and sensor window may prevent proper operation.

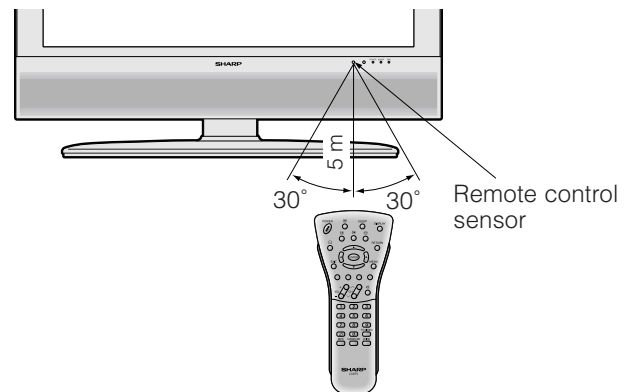

## Cautions regarding remote control unit

- Do not subject the remote control unit to shock. In addition, do not soak the remote control unit with liquids, or place it in an area with high humidity.
- Do not install or place the remote control unit under direct sunlight. The heat may cause deformation of the unit.
- The remote control unit may not work properly if the remote sensor window of the TV is under direct sunlight or strong lighting. In such case, change the angle of the lighting or TV, or operate the remote control unit closer to the remote sensor window.

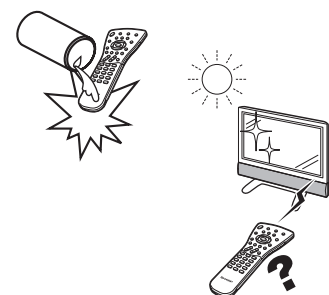

## Setting the TV

### Notes on installing the TV

- Avoid direct sunlight and place the TV in a well-ventilated location.
- Place the TV in a level location.

#### 1 Removing the terminal cover

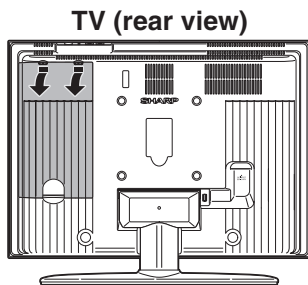

Press down the hooks to remove the cover toward you.

#### 2 Connecting the AC cord, antenna, and external equipment to the TV

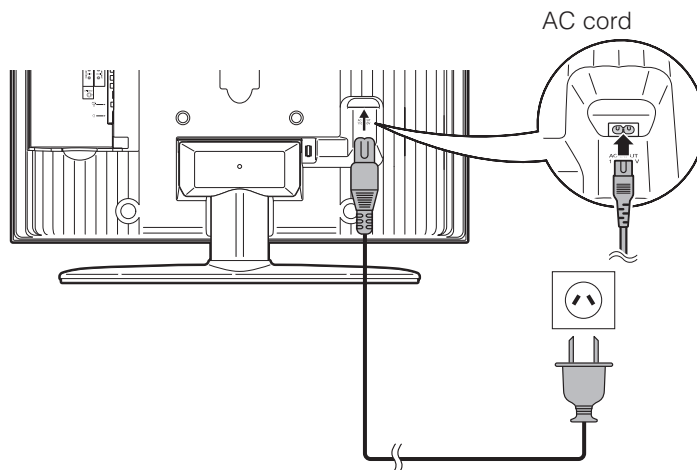

See pages 9 and 41–43 for connecting antennas and external equipment, such as VCR and DVD player.

#### 3 Bundling the cables and closing the terminal cover

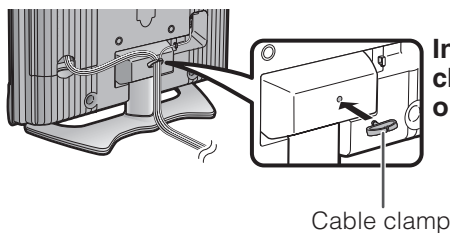

Insert the cable clamp in the hole on the TV as shown.

Cable clamp

#### CAUTION

- TO PREVENT RISK OF ELECTRIC SHOCK, DO NOT TOUCH UN-INSULATED PARTS OF ANY CABLES WITH THE AC CORD CONNECTED.

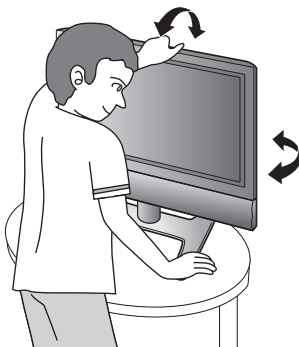

#### CAUTION

**Adjust the screen with both hands. Put one hand on the TV and tilt the screen while steadying the stand with your other hand.**

To change the vertical angle of the TV, tilt the screen up to 2 degrees forward or 6 degrees backward. The TV can also be rotated up to 10 degrees to the right or left.



## Preparation

### Protection against overturning

There is a danger of the product overturning in the case of a disaster or sudden collision. Carry out the following tip-resistant measurement for your safety.

#### Anchoring the TV to the wall or a pillar

- 1 Fix the product with the 2 clamps (supplied), using the screws (supplied).
- 2 Fix the TV to the wall using extra strong ties (commercially available).

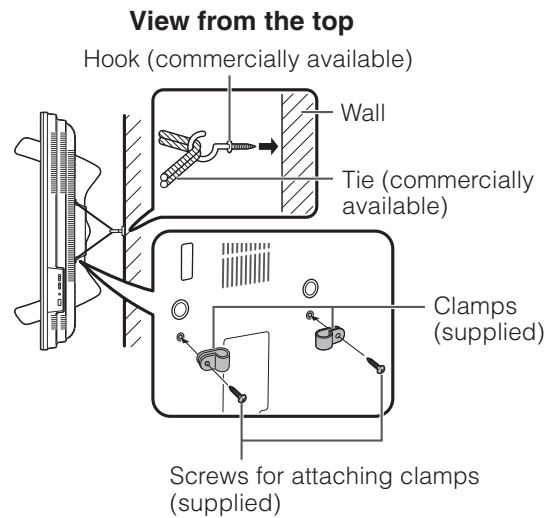

#### Fixing the TV to the table

- 1 Lay the TV down on cushioning (such as a blanket) over a table.
- 2 Attach the band (supplied) to the bottom of the stand using the screw (supplied).
- 3 Transfer the product to the table where you intend to fix the TV.
- 4 Fix the TV to the table by the band with a screw (commercially available).
  - Use a screw (commercially available) whose shape is compatible with the band.

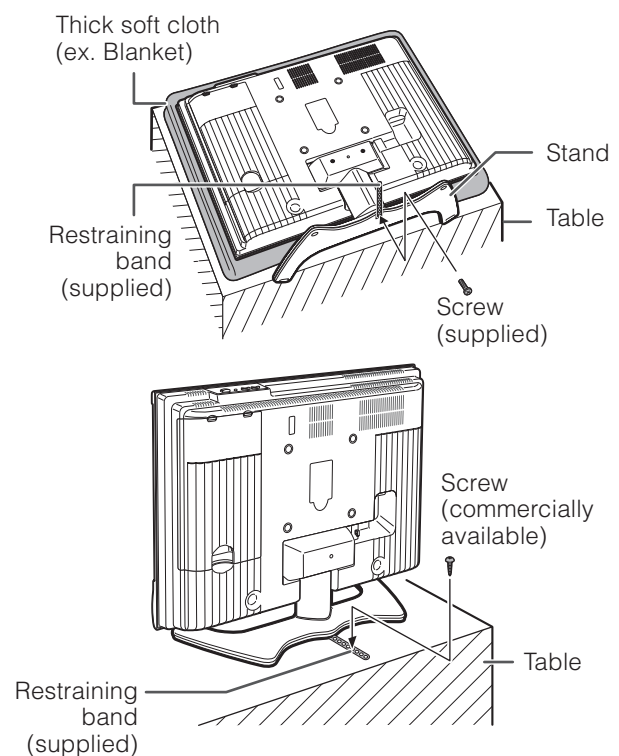

### CAUTION

- As this product is heavy, use a table that is wide enough to support the product and capable of withstanding the product's weight. The table should be set where it will not be overturned.

## Preparation

Simple operations for watching a TV programme

### Basic connection

#### Connecting to an antenna

To enjoy a clearer picture, use an outdoor antenna. The following is a brief explanation of the types of connections that are used for coaxial cable.

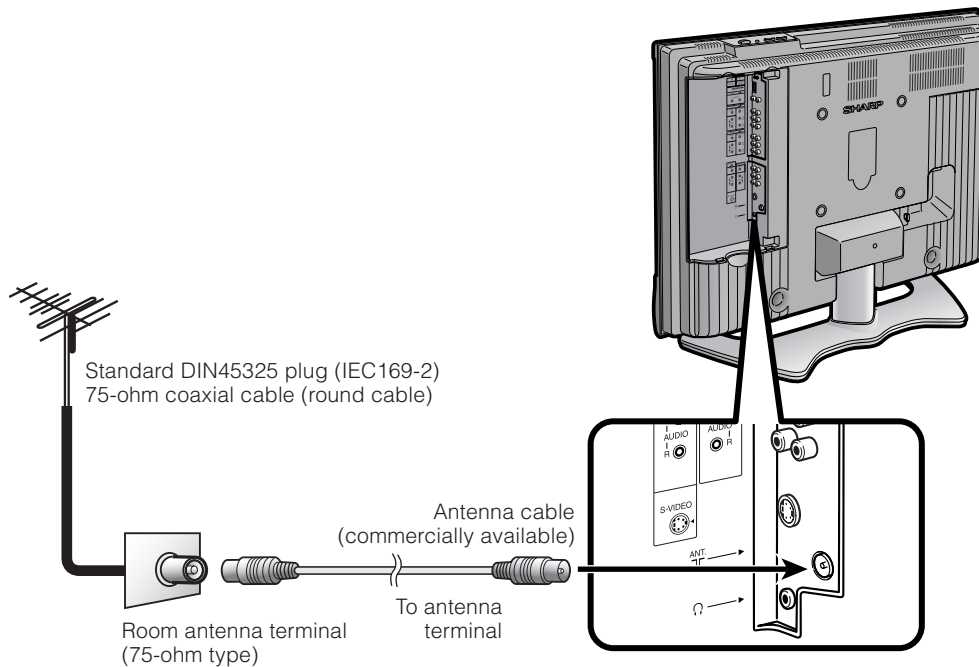

#### Connecting to the power outlet

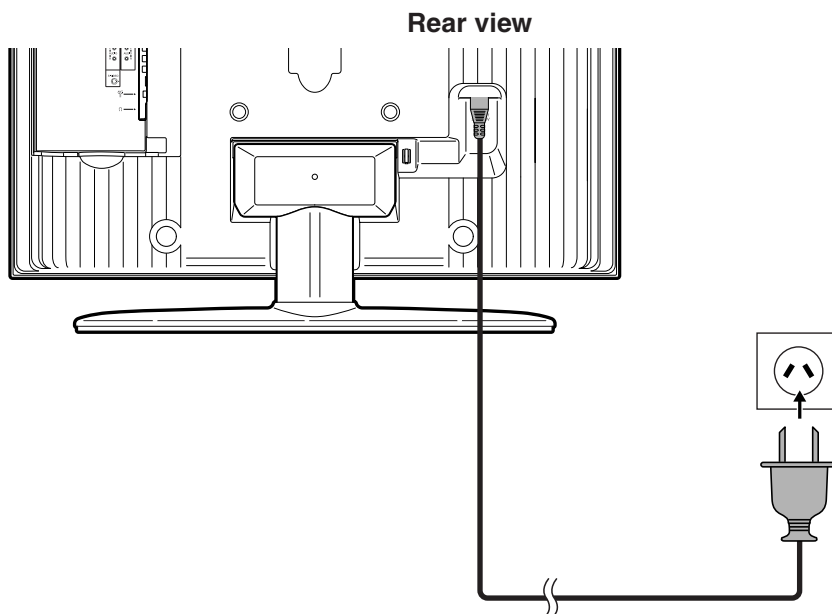

#### NOTE

- Always turn off the power of the TV when connecting the AC cord.
- Disconnect the AC cord from the AC outlet if the TV will not be used for a long period of time.

## Preparation

### Setting the TV on the wall

- You can mount the TV on the wall, using the optional AN-37AG2 bracket for LC-32AX3X/LC-37AX3X.
- For details, refer to the instructions supplied with the optional bracket.

#### CAUTION

- **Installing the Liquid Crystal Television requires special skill that should only be performed by qualified service personnel. Customers should not attempt to do the work themselves. SHARP bears no responsibility for improper mounting or mounting that results in accident or injury.**

#### <Example>

##### Hanging on the wall

Wall mount bracket. (See the bracket instructions for details.)

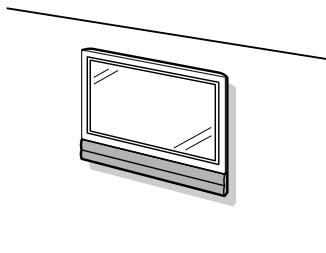

##### Regarding the angle when mounting the TV on the wall

- The maximum angle to which you can tilt the wall-mounted TV is as follows. Do not tilt it more than the maximum angle.

LC-32AX3X	Up to 10°
LC-37AX3X	Up to 5°

- Tilt the wall-mounted TV slowly when adjusting its angle.

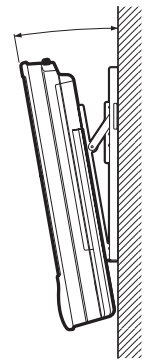

### Removing the stand

For wall mounting with the optional bracket, remove the stand.

#### Before attaching/detaching stand

- Before detaching (or attaching) stand, unplug the AC cord from the AC outlet.
- Remove all terminal covers and connected cables.
- Lay the TV down on cushioning (such as a blanket) over a table.
- Make sure two or more people perform the operation.

#### CAUTION

- **Do not remove the stand from the TV unless using an optional bracket to mount it.**

1

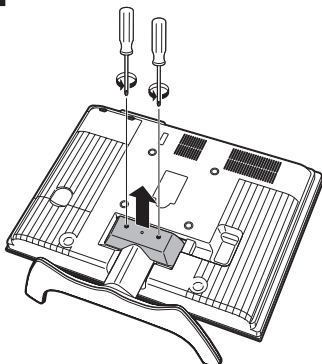

Unfasten the two screws used to secure the cover in place.

2

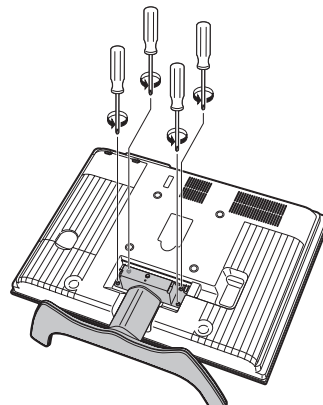

Unfasten the four screws used to secure the stand in place.

3

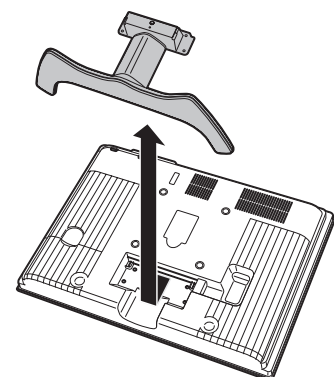

Detach the stand from the TV. (Hold the stand so it will not drop from the edge of the base area.)

#### NOTE

- To attach the stand, perform the above steps in reverse order.

# Part names

## TV (Front)

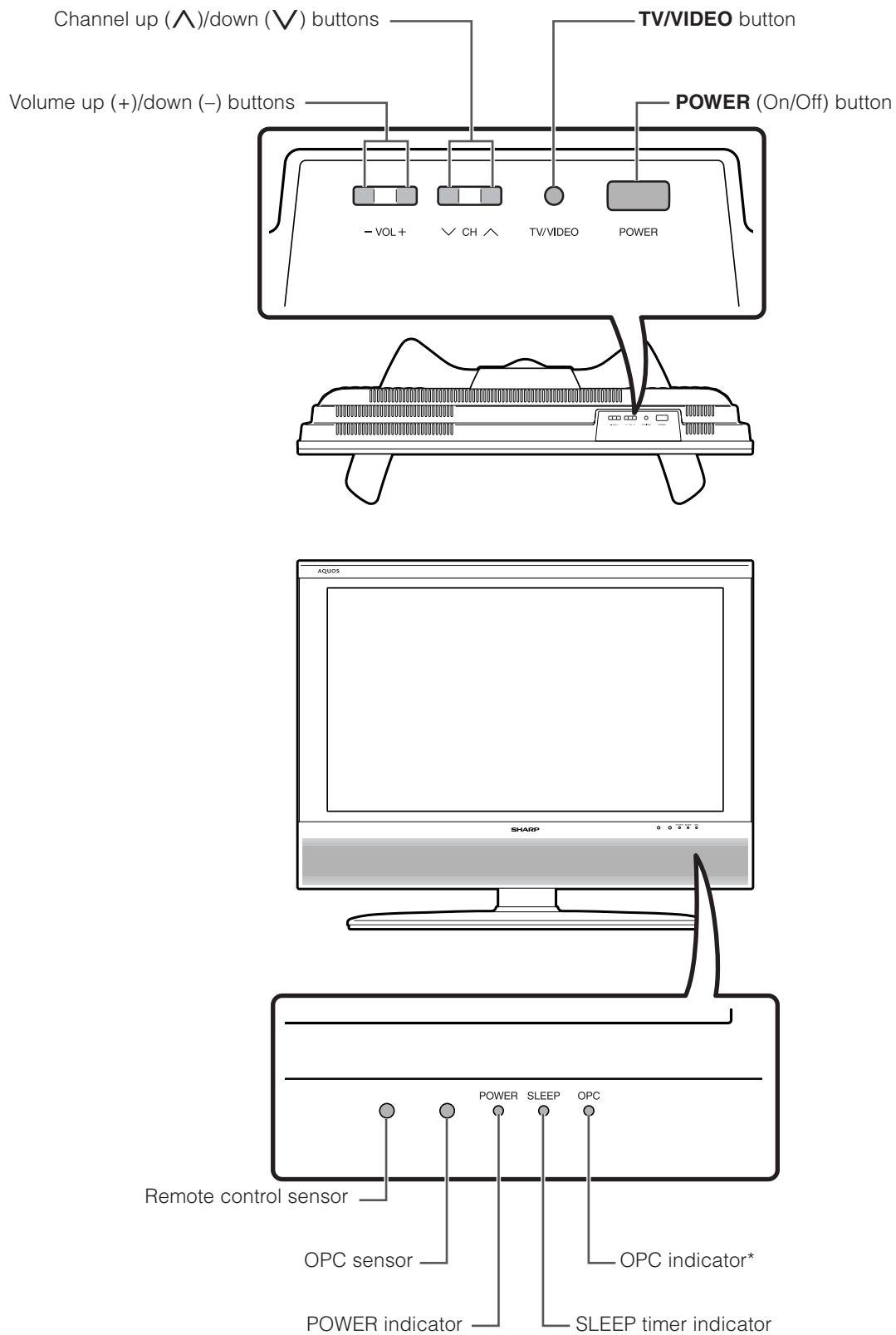

\*OPC: Optical Picture Control  
(See page 25.)

## Part names

### TV (Rear)

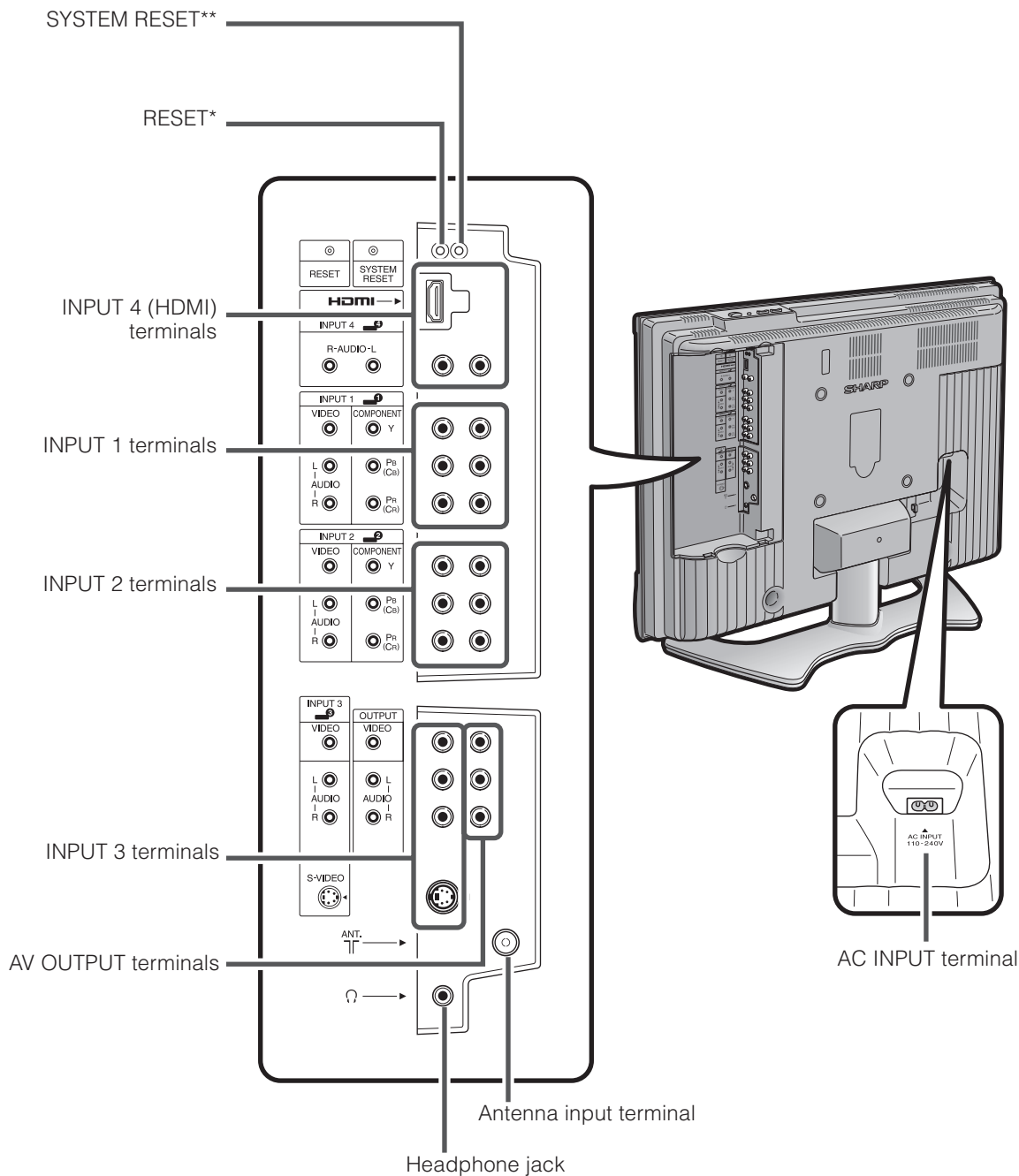

\* Press **RESET** if the TV cannot return to its original state after performing various operations. This will reset the TV as shown below.

- "AV MODE" resets to "USER".
- TV channel resets to channel 1.
- Sound volume is initialised.
- Image position is initialised.
- Still image mode deactivates.
- Teletext mode resets to normal.
- "Audio Only" setting resets to "Off".
- "Rotate" resets to "Normal".

\*\* Press **SYSTEM RESET** if the TV does not operate after starting up.

#### NOTE

- Pressing **RESET** will not work if the TV is in standby mode (indicator lights red).
- Pressing **RESET** will not delete channel preset and password. See page 30 for resetting the password. See page 47 for initialising to the factory preset values in case you forget your password.

## Part names

### Remote control unit

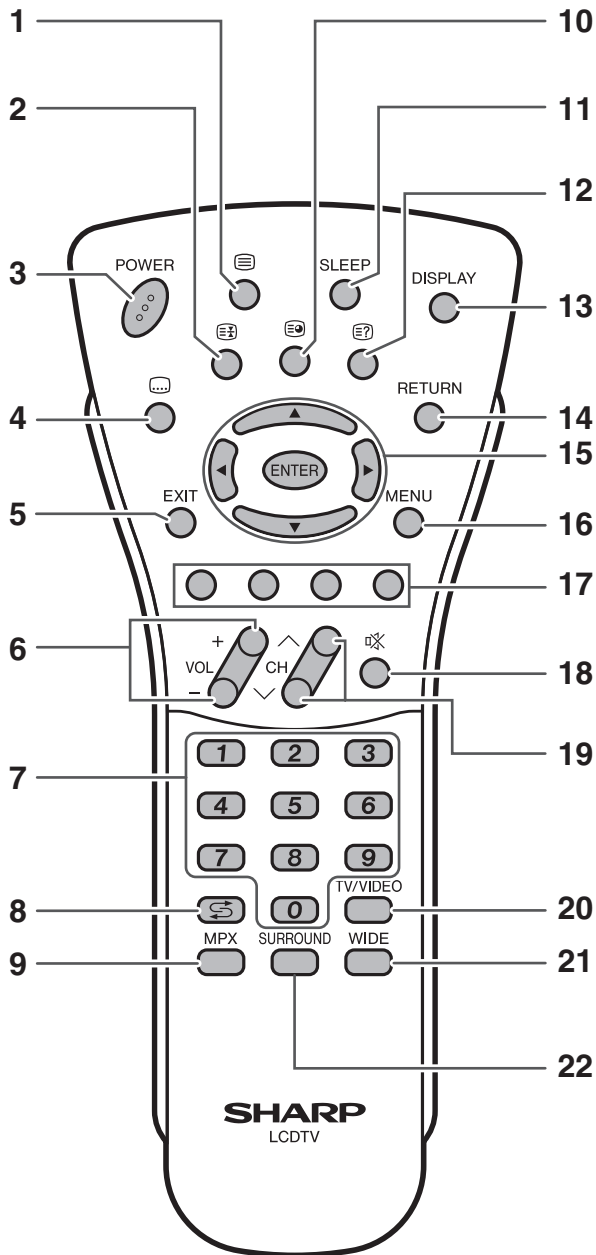

- 1 **☰ (TELETEXT)**  
Select the TELETEXT mode. (all TV image, all TEXT image, TV/TEXT image) (See pages 39 and 40.)
- 2 **⏸ (Freeze/Hold)**  
Freeze a motion picture on the screen. (See page 17.)  
TELETEXT mode: Stop updating Teletext pages automatically. Press **⏸** again to release the hold mode. (See page 39.)
- 3 **POWER (STANDBY/ON)**  
To switch the power on and off. (See page 14.)
- 4 **☰ (SUBTITLE for TELETEXT)**  
To turn the subtitles on and off. (See page 40.)
- 5 **EXIT**  
Turn off the On Screen Display.
- 6 **VOL - /VOL +**  
Set the volume. (See page 17.)
- 7 **0 - 9**  
Set the channel. (See page 15.)  
TELETEXT mode: Set the page. (See page 39.)
- 8 **↶ (Flashback)**  
Press to return to the previous image in normal viewing mode. (See page 15.)
- 9 **MPX**  
Select the sound multiplex mode. (See page 16.)
- 10 **☰ (Subpage)**  
Reveal or hide subpages. (See page 40.)
- 11 **SLEEP**  
Set the Sleep timer. (See page 17.)
- 12 **☰ (Reveal hidden for TELETEXT)**  
TELETEXT mode: Display hidden characters. (See page 39.)
- 13 **DISPLAY**  
Display the programme information.  
TELETEXT mode: Display the time information included in the Teletext broadcast. (See page 40.)
- 14 **RETURN**  
MENU mode: Return to the previous menu screen. (See page 18.)
- 15 **▲/▼/◀/▶ (Cursor)**  
Select a desired item on the setting screen. (See page 18.)
- 16 **ENTER**  
Execute a command.
- 17 **MENU**  
Display the menu screen. (See page 18.)
- 18 **Colour (RED/GREEN/YELLOW/BLUE)**  
TELETEXT mode: Select a page. (See page 39.)
- 19 **⏸ (MUTE)**  
Mute the sound. (See page 17.)
- 20 **CH^/CHv**  
TV input mode: Select the channel. (See page 15.)  
TELETEXT mode: Select the page. (See page 39.)
- 21 **TV/VIDEO (INPUT SOURCE)**  
Select an input source. (TV, INPUT 1, INPUT 2, INPUT 3, INPUT 4) (See pages 31, 36 and 41.)
- 22 **WIDE**  
Change the wide image mode. (See page 33.)  
TELETEXT mode: Set the area of magnification. (full/upper half/lower half) (See page 39.)
- 23 **SURROUND**  
Select Surround settings. (See page 29.)

#### NOTE

- When using the remote control unit, point it at the TV.

# Watching TV

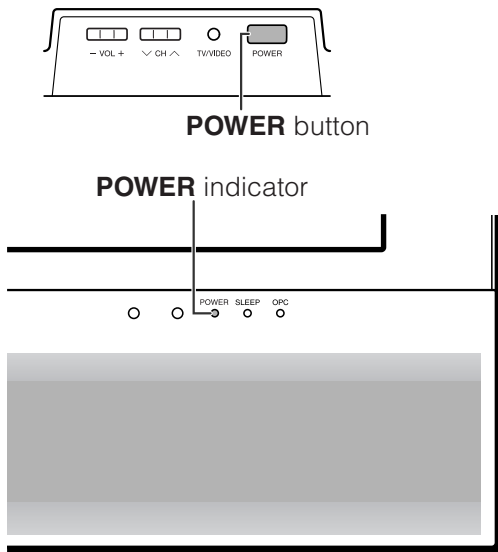

## Turning on the power

Press **POWER** on the TV.

- **POWER indicator (Green):** The TV is on. (After a few seconds, an image appears with sound.)
- After turning the power "ON" by pressing **POWER** on the TV, you can turn the power ON/OFF by pressing **POWER** on the remote control.

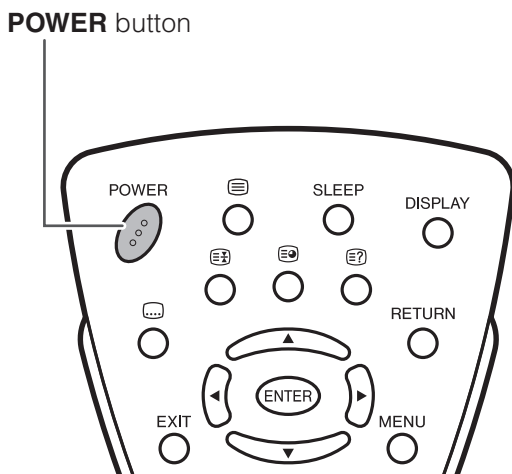

## Turning off the power

Press **POWER** on the remote control.

- The TV enters standby mode and the image on the screen disappears.
- The **POWER indicator** on the TV changes from green to red.

Press **POWER** on the TV.

- The **POWER indicator** on the TV turns off.
- When the TV is turned off by **POWER**, you cannot turn on the power by pressing **POWER** on the remote control.

### POWER indicator

Off	Power off
Red	The TV is in standby mode.
Green	The TV is on.

### NOTE

- If you are not going to use this TV for a long period of time, be sure to remove the AC cord from the power outlet.
- Minor power is consumed when the unit is in standby mode.

## Watching TV

### Simple button operations for changing channels

You can change channels in several ways.

#### Using CH $\wedge$ / $\vee$ on the remote control unit

- Press **CH $\wedge$**  to increase the channel number.
- Press **CH $\vee$**  to decrease the channel number.

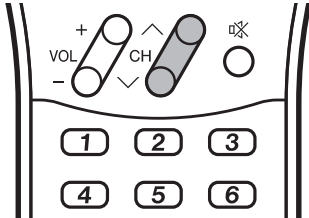

#### NOTE

- **CH $\wedge$ / $\vee$**  on the TV operates the same as  $\wedge$ / $\vee$  on the remote control unit.

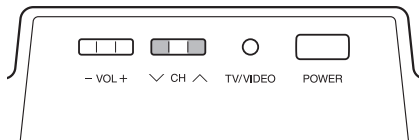

#### Using 0 – 9 on the remote control unit

Select the channels directly by pressing buttons **0** to **9**.

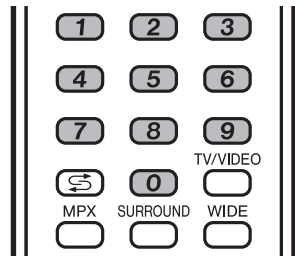

#### EXAMPLE

To select a 1-digit channel (e.g. channel 2):

- Press **0**, followed by **2**.

To select a 2-digit channel (e.g. channel 12):

- Press **1**, followed by **2**.

#### When viewing Teletext information

View a page directly which is 3-digit page number from 100 to 899 by pressing buttons **0** to **9**.

#### Channel display

Channel display changes approximately after 3 seconds as shown below.

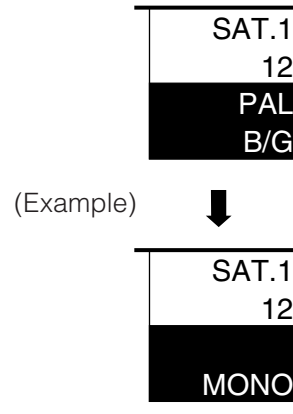

#### Using Flashback ( $\$$ ) on the remote control unit

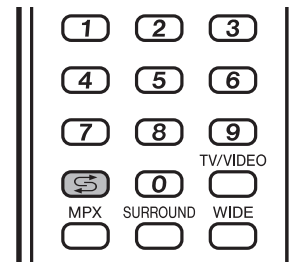

Press  $\$$  to switch the currently tuned channel to the previously tuned channel.

Press  $\$$  again to switch back to the currently tuned channel.

Press  $\$$  to toggle between the currently selected input source and the previously selected one.

Press  $\$$  to return to the previous page in TELETEXT mode.



## Watching TV

### Using MPX on the remote control unit

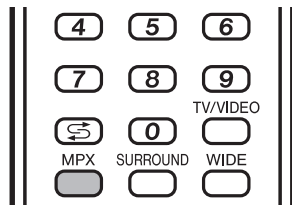

#### In the NICAM TV broadcasts

##### When receiving a stereo signal

Each time you press **MPX**, the mode switches between NICAM STEREO and MONO.

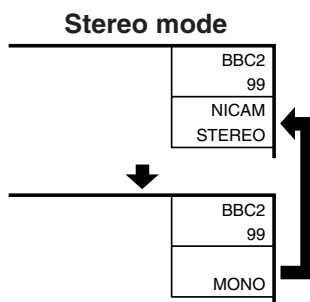

##### When receiving a bilingual signal

Each time you press **MPX**, the mode switches among NICAM CH A, NICAM CH B, NICAM CH AB and MONO.

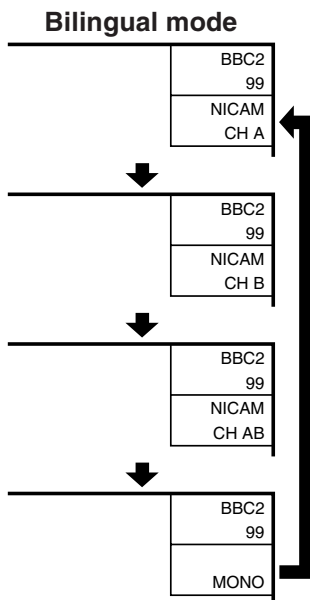

##### When receiving a monaural signal

Each time you press **MPX**, the mode switches between NICAM MONO and MONO.

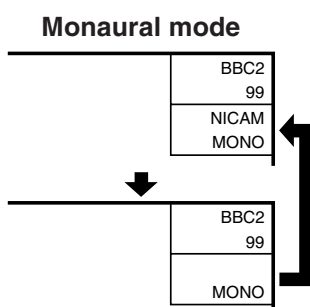

#### In the TV mode of A2 TV broadcasts

##### When receiving a stereo signal

Each time you press **MPX**, the mode switches between STEREO and MONO.

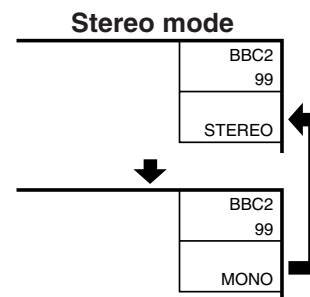

##### When receiving a bilingual signal

Each time you press **MPX**, the mode switches among CH A, CH B and CH AB.

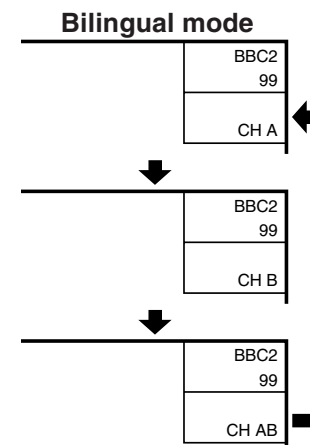

##### When receiving a monaural signal

When you press **MPX**, "MONO" displays.

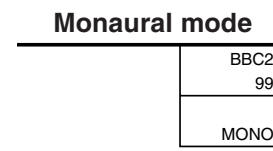

#### NOTE

- "BBC2" and "99" are tentative network name and channel.

## Watching TV

### Simple button operation for changing volume/sound

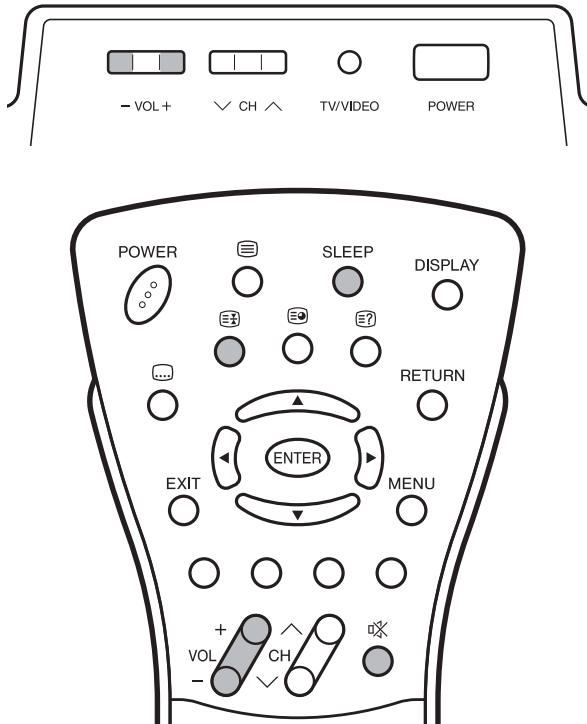

### Changing the volume

You can change the volume on the TV or on the remote control unit.

- To increase the volume, press **VOL +**.
- To decrease the volume, press **VOL -**.



#### NOTE

- "TV", "INPUT1", "INPUT2", "INPUT3" and "INPUT4" modes can store volume adjustment values separately.

### Using (Mute) on the remote control unit

 mutes the current sound output.

1



Press .

- The sound is silenced.
- "" has been displayed on the screen for 30 minutes.

**Mute**



#### NOTE

- Within 30 minutes after pressing , press one of the buttons below to cancel the mute.  
—VOL - /VOL +  
—
- **Mute will be cancelled after 30 minutes. However, the TV will not suddenly output loud sound as the volume level will be set to 0 automatically. Increase the volume level by pressing VOL +.**

2

Press  again within 30 minutes to cancel the mute.

- Before 30 minutes, the volume level returns to the previous setting.

### Sleep timer

Allows you to set a time when the TV automatically switches to standby.

1

Press **SLEEP**.

- Remaining time displays when sleep timer has been set.

Sleep Timer: Remain 2 hr. 00 min.

2

Each time you press **SLEEP**, the remaining time switches as shown below.

0 hr. 30 min. → 1 hr. 00 min. → 1 hr. 30 min.

↑ Off ← 2 hr. 30 min. ← 2 hr. 00 min. ↓

#### NOTE

- When the time has been set, countdown automatically starts.
- Five minutes before the preset of time expires, the remaining time displays each minute.
- Select "Off" by pressing **SLEEP** to cancel the sleep timer.

### Still image

You can freeze a motion picture on the screen.

1

Press .

2

Press  again to exit still image.

#### NOTE

- When this function is not available, "No still image display available." will display.
- The still image automatically goes out after 30 minutes.
- When you freeze the picture, an icon is displayed at the lower left corner of the screen.

# Basic adjustment settings

## Menu operation buttons

Use the following buttons on the remote control to operate the menu.

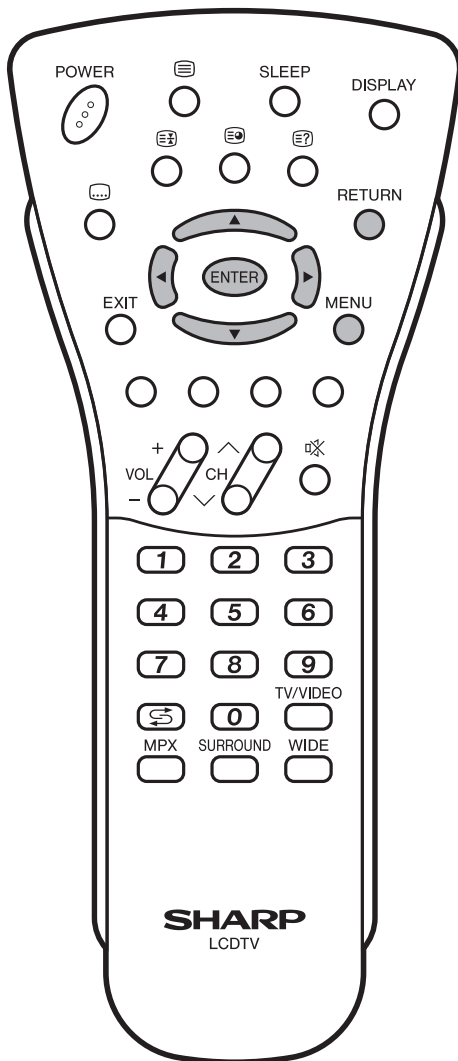

**MENU:** Press to open or close the menu screen.

**▲/▼/◀/▶:** Press to select a desired item on the screen or adjust a selected item.

**ENTER:** Press to go to the next step or complete the setting.

**RETURN:** Press to return to the previous step.

## On-Screen Display

### Example

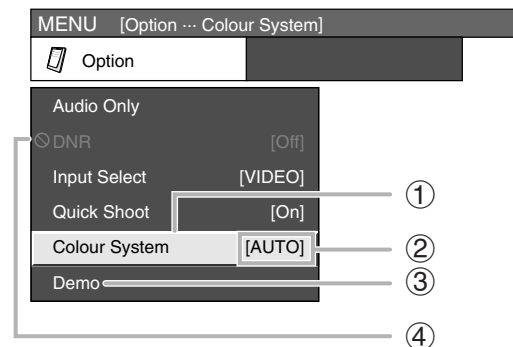

- ① Item displayed in yellow
  - This indicates the item currently selected.
  - Press **ENTER** to go to the adjustment screen for this item.
- ② Item in brackets
  - This indicates the current setting for the item.
- ③ Item displayed in white
  - This indicates an item can be selected.
- ④ Item displayed in grey
  - This indicates that the item cannot be selected.
  - \*There are various reasons why items cannot be selected, but the main reasons are as follows:
    1. Nothing is connected to the selected input terminal.
    2. The function is not compatible with the current input signal.

### NOTE

- Menu options differ in the selected input modes, but the operating procedures are the same.
- The screens in the operation manual are for explanation purposes (some are enlarged, others cropped) and may vary slightly from the actual screens.

## Basic adjustment settings

### Menu items

List of menu items to help you with operations

#### Picture

AV Mode .....	Page 25
OPC .....	Page 25
Backlight .....	Page 26
Contrast .....	Page 26
Brightness .....	Page 26
Colour .....	Page 26
Tint .....	Page 26
Sharpness .....	Page 26
Advanced	
Colour Temp. ....	Page 27
Black .....	Page 27
3D-Y/C .....	Page 27
Monochrome .....	Page 28
Film Mode .....	Page 28
I/P Setting .....	Page 28

#### Audio

AV Mode .....	Page 28
Treble .....	Page 28
Bass .....	Page 28
Balance .....	Page 28
Surround .....	Page 29

#### Power Control

No Signal Off .....	Page 29
No Operation Off .....	Page 29

#### Setup

Auto Installation .....	Page 20
Programme Setup .....	Pages 20-24
Child Lock .....	Page 30
Input Label .....	Page 31
Position .....	Page 31
WSS .....	Page 32
4:3 Mode .....	Page 32
Rotate .....	Page 34
Language .....	Page 34
Text Language .....	Page 38

#### Option

Audio Only .....	Page 35
DNR .....	Page 35
HDMI Setup .....	Page 35
Input Select .....	Page 36
Quick Shoot .....	Page 36
Colour System .....	Page 37
Demo .....	Page 37

## Basic adjustment settings

### Auto installation

You can run auto installation again, even after setting up the preset channels.

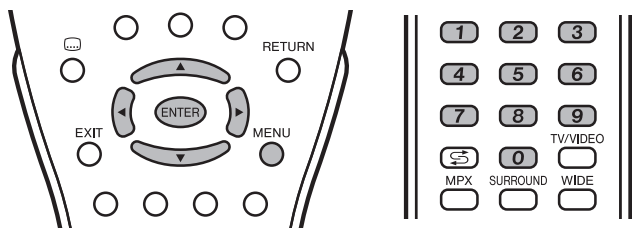

**1** Press **MENU** and the MENU screen displays.

**2** Press **◀/▶** to select "Setup".

**3** Press **▲/▼** to select "Auto Installation", and then press **ENTER**.

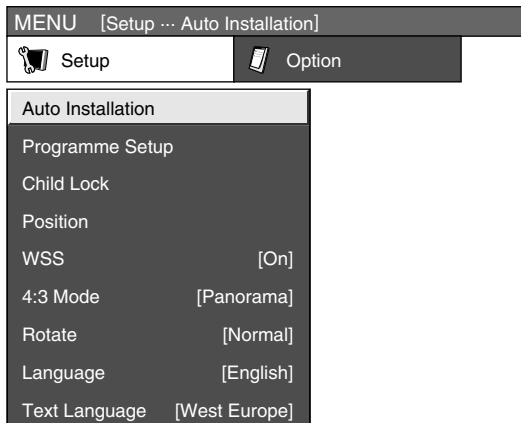

**4** If you have already set the password, enter it here.

- See page 30 for setting a password.

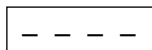

**5** Press **◀/▶** to select "Yes", and then press **ENTER**.

**6** Press **▲/▼** to select the desired language listed on the screen, and then press **ENTER**. After this setting, auto search starts with the following order.

- ① Programme auto search
- ② Auto labelling
- ③ Auto sorting

You do not need to do anything during the auto search.

#### NOTE

- After performing step 6, the menu screen shown in step 3 will reappear. Do not turn off the TV before then, because the TV is saving the data found.

### Programme setup

You can run the auto search procedure again at any time by accessing the Setup menu and Programme Setup. Channels can be tuned automatically or manually.

#### Auto search

You can also automatically search by performing the procedure below. This is the same function as programme auto search in auto installation.

**1** Press **MENU** and the MENU screen displays.

**2** Press **◀/▶** to select "Setup".

**3** Press **▲/▼** to select "Programme Setup", and then press **ENTER**.

If you have already set the password, enter it here.

- See page 30 for setting a password.

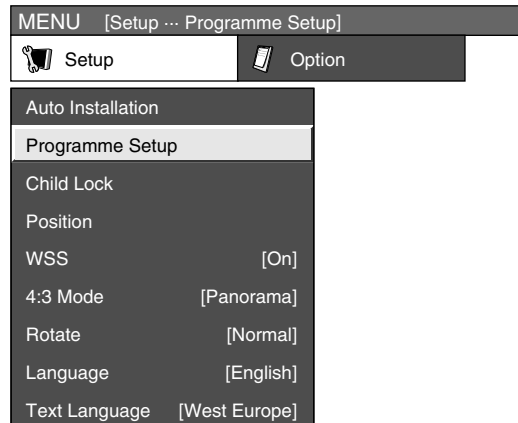

**4** Press **▲/▼** to select "Auto Search", and then press **ENTER**.

**5** Press **◀/▶** to select "Yes", and then press **ENTER**.

- Auto search starts with the following order.
  - ① Programme auto search
  - ② Auto labelling
  - ③ Auto sorting

#### NOTE

- After performing step 5, the menu screen shown in step 3 will reappear. Do not turn off the TV before then, because the TV is saving the data found.

## Basic adjustment settings

### Manual setting for each channel

You can set some channel items manually. They are Search, Fine (TV frequency), Colour sys., Sound sys., Label (Network name), Skip and Lock (Child Lock).

**1** Press **MENU** and the MENU screen displays.

**2** Press **◀/▶** to select "Setup".

**3** Press **▲/▼** to select "Programme Setup", and then press **ENTER**.  
If you have already set the password, enter it here.  
• See page 30 for setting a password.

**4** Press **▲/▼** to select "Manual Adjust", and then press **ENTER**.

**5** Press **◀/▶** to select "Yes", and then press **ENTER**.

#### Programme Setup "Manual Adjust" menu

01 SAT.1	02 PR07	03 KABEL		

Next

You can select one of the following settings.

- ① **Search** (See page 21.)
- ② **Fine** (See page 21.)
- ③ **Colour system** (See page 22.)
- ④ **Sound system** (See page 22.)
- ⑤ **Label** (See page 22.)
- ⑥ **Skip** (See page 23.)
- ⑦ **Lock** (See page 23.)

### Search tuning

**1** Press **▲/▼/◀/▶** to select the channel you want to edit, and then press **ENTER**.  
• The selected channel information displays.

**2** Press **▲/▼** to select "Search", and then press **ENTER**.

MENU [Setup ... Programme Setup]	
Search	
Fine	[179.25] 179.25 MHz
Colour sys.	[AUTO] NEXT
Sound sys.	[B/G] STORE
Label	[SAT.1] CANCEL
Skip	[Off]
Lock	[Off]

**3** Press **▲/▼** to select item and press **ENTER**.  
• **NEXT**: Search the next channel.  
• **STORE**: Memorise the current display channel.  
• **CANCEL**: Return to the previous screen. (The search result will not be stored.)

### Fine tuning

**1** Press **▲/▼/◀/▶** to select the channel you want to edit, and then press **ENTER**.  
• The selected channel information displays.

**2** Press **▲/▼** to select "Fine", and then press **ENTER**.

**3** Press **◀/▶** to adjust the frequency, and then press **ENTER**.  
• Adjust while checking the background picture as a reference.

Search	
Fine	[179.25] 179.25 MHz
Colour sys.	[AUTO]
Sound sys.	[B/G]
Label	[SAT.1]
Skip	[Off]
Lock	[Off]

• Instead of the method above, you can also set by directly entering the frequency number of the channel with **0 - 9**.

#### EXAMPLE

- 179.25 MHz: Press **1** → **7** → **9** → **2** → **5**.
- 49.25 MHz: Press **4** → **9** → **2** → **5** → **ENTER**.

## Basic adjustment settings

### Manual setting for each channel (continued)

#### Colour system

- 1 Press ▲/▼/◀/▶ to select the channel you want to edit, and then press **ENTER**.
  - The selected channel information displays.

- 2 Press ▲/▼ to select “Colour sys.”, and then press **ENTER**.
  - Receivable colour systems are listed.

#### Colour system menu

MENU [Setup -- Programme Setup]	
Search	
Fine [179.25]	
Colour sys. [AUTO]	AUTO
Sound sys. [B/G]	PAL
Label [SAT.1]	SECAM
Skip [Off]	NTSC 3.58
Lock [Off]	NTSC 4.43
	PAL-60

- 3 Press ▲/▼ to select the optimum colour system, and then press **ENTER**.

#### Sound system (Broadcasting system)

- 1 Press ▲/▼/◀/▶ to select the channel you want to edit, and then press **ENTER**.
  - The selected channel information displays.

- 2 Press ▲/▼ to select “Sound sys.”, and then press **ENTER**.
  - Receivable sound systems (Broadcasting systems) are listed.

#### Sound system menu

Search	
Fine [179.25]	
Colour sys. [AUTO]	
Sound sys. [B/G]	B/G
Label [SAT.1]	D/K
Skip [Off]	I
Lock [Off]	M

- 3 Press ▲/▼ to select the optimum sound system, and then press **ENTER**.

#### NOTE

- Check the colour system (see above) if the sound output were not correct.

#### Labelling channels

When a TV channel sends its Network Name, the auto installation detects the information and assigns a name to it. However, you can change individual channel names.

- 1 Press ▲/▼/◀/▶ to select the channel you want to edit, and then press **ENTER**.
  - The selected channel information displays.

- 2 Press ▲/▼ to select “Label”, and then press **ENTER**.
  - Alphabets and numbers are listed.

#### Labelling menu

Search	
Fine [179.25]	
Colour sys. [AUTO]	A B C D E F G H I J CLEAR
Sound sys. [B/G]	K L M N O P Q R S T BACK
Label [SAT.1]	U V W X Y Z + - . _
Skip [Off]	0 1 2 3 4 5 6 7 8 9 END
Lock [Off]	

- 3 Press ▲/▼/◀/▶ to select each character of the new name for the channel, and then press **ENTER**.

- 4 Repeat until the name is fully spelt out.
  - The name can be 5 characters or less.
  - When you want to set a channel name of less than 5 characters, select “END”, then press **ENTER** to exit from the labelling menu.

## Basic adjustment settings

### Manual setting for each channel (continued)

#### Skipping channels

Channels with “Skip” set to “On” are passed over when using **CH**  $\wedge$   $\vee$  even if selected while watching the image from the TV.

- 1 Press  $\blacktriangle$ / $\blacktriangledown$ / $\blacktriangleleft$ / $\blacktriangleright$  to select the channel you want to edit, and then press **ENTER**.
  - The selected channel information will be displayed.

- 2 Press  $\blacktriangle$ / $\blacktriangledown$  to select “Skip”, and then press **ENTER**.
  - Skip menu displays.

**Skip menu**

MENU [Setup ... Programme Setup]	
Search	
Fine [179.25]	Off
Colour sys. [AUTO]	
Sound sys. [B/G]	On
Label [SAT.1]	
Skip [Off]	
Lock [Off]	

- 3 Press  $\blacktriangle$ / $\blacktriangledown$  to set “Skip” to “On”, and then press **ENTER**.

#### Setting the child lock

You can block the viewing of any channel.

- 1 Press  $\blacktriangle$ / $\blacktriangledown$ / $\blacktriangleleft$ / $\blacktriangleright$  to select the channel you want to edit, and then press **ENTER**.
  - The selected channel information will be displayed.

- 2 Press  $\blacktriangle$ / $\blacktriangledown$  to select “Lock”, and then press **ENTER**.
  - Child lock menu will be displayed.

**Lock menu**

Search	
Fine [179.25]	Off
Colour sys. [AUTO]	
Sound sys. [B/G]	On
Label [SAT.1]	
Skip [Off]	
Lock [Off]	

- 3 Press  $\blacktriangle$ / $\blacktriangledown$  to set “Lock” to “On”, and then press **ENTER**.

#### NOTE

- You need to set a password when using the child lock function. See page 30 for setting a password.
- If “Lock” is set to “On” for a channel, “Child lock has been activated.” is displayed when you select the channel, and the image and sound of the channel is blocked.
- When pressing **ENTER** while “Child lock has been activated.” is displayed, password input menu will be displayed. Inputting the correct password lifts the child lock temporarily until the power is turned off.

### Sort

Channel positions can be sorted freely.

- 1 Press **MENU** and the MENU screen displays.

- 2 Press  $\blacktriangleleft$ / $\blacktriangleright$  to select “Setup”.

- 3 Press  $\blacktriangle$ / $\blacktriangledown$  to select “Programme Setup”, and then press **ENTER**.
  - If you already set the password, enter it here.
  - See page 30 for setting a password.

- 4 Press  $\blacktriangle$ / $\blacktriangledown$  to select “Sort”, and then press **ENTER**.

- 5 Press  $\blacktriangleleft$ / $\blacktriangleright$  to select “Yes”, and then press **ENTER**.

- 6 Press  $\blacktriangle$ / $\blacktriangledown$ / $\blacktriangleleft$ / $\blacktriangleright$  to select the channel you want to move, and then press **ENTER**.

- 7 Move it to the desired position by pressing  $\blacktriangle$ / $\blacktriangledown$ / $\blacktriangleleft$ / $\blacktriangleright$ , and then press **ENTER**.

- 8 Repeat the steps 6 and 7 until all desired channels are sorted.

#### Sort menus

01 SAT.1 $\leftrightarrow$				
01 SAT.1	02 KABEL	03	04	05
06				
Next				



01 SAT.1 $\leftrightarrow$ 02 KABEL				
01 SAT.1	02 KABEL			
Next				



01 KABEL $\leftrightarrow$				
01 KABEL	02 SAT.1			
Next				



## Basic adjustment settings

### Erase Programme

The individual programme can be erased.

- 1 Press **MENU** and the MENU screen displays.
- 2 Press **◀/▶** to select "Setup".
- 3 Press **▲/▼** to select "Programme Setup", and then press **ENTER**.  
If you already set the password, enter it here.
  - See page 30 for setting a password.
- 4 Press **▲/▼** to select "Erase Programme", and then press **ENTER**.
- 5 Press **◀/▶** to select "Yes", and then press **ENTER**.
- 6 Press **▲/▼/◀/▶** to select the channel you want to erase, and then press **ENTER**.
  - A message screen pops up.
- 7 Press **◀/▶** to select "Yes", and then press **ENTER** to erase the selected programme. All the subsequent programmes move up.
- 8 Repeat the steps 6 and 7 until all desired channels are erased.

#### Erase programme menus

01 SAT.1				
01 SAT.1	02 Pro7	03 KABEL	04	05
06	07	08	09	10
11	12	13	14	15
16	17	18	19	20
Next				



02 Pro7				
01 SAT.1	02 Pro7	03 KABEL	04	05
06	07	08	09	10
11	12	13	14	15
16	17	18	19	20
Next				



02 KABEL				
01 SAT.1	02 KABEL	03	04	05
06	07	08	09	10
11	12	13	14	15
16	17	18	19	20
Next				

## Basic adjustment settings

### AV mode selection

AV mode gives you five viewing options to choose from to best match the system environment, which can vary due to factors like room-brightness, type of programme watched or the type of image input from external equipment.

- 1 Press **MENU** and the MENU screen displays.
- 2 Press **◀/▶** to select "Picture" or "Audio".
- 3 Press **▲/▼** to select "AV Mode", and then press **ENTER**.
- 4 Press **▲/▼/◀/▶** to select the desired item, and then press **ENTER**.

Selected item	Description
<b>STANDARD</b>	For a highly defined image in a normally bright room
<b>MOVIE</b>	For a movie
<b>GAME</b>	Lowers image brightness for easier viewing.
<b>USER</b>	Allows the user to customise settings as desired. You can set the mode for each input source.
<b>DYNAMIC</b>	For a clear-cut image emphasising high contrast for sports viewing

#### NOTE

- You can select a different AV MODE item for each input mode. (For example, select STANDARD for TV input and DYNAMIC for VIDEO input.)

### OPC (Optical Picture Control) setting

You can set the TV to automatically adjust the screen to suitable backlight brightness according to the lighting conditions.

- 1 Press **MENU** and the MENU screen displays.
- 2 Press **◀/▶** to select "Picture".
- 3 Press **▲/▼** to select "OPC", and then press **ENTER**.
- 4 Press **▲/▼** to select "On", and then press **ENTER**.

Selected item	Description
<b>Off</b>	The brightness is fixed at the value set in "Backlight" (See page 26).
<b>On</b>	Automatically adjusts
<b>On (Display)</b>	Displays the OPC effect on the screen while adjusting the brightness of the screen.

#### NOTE

- Make sure no object obstructs the OPC sensor, which could affect its ability to sense surrounding light.

## Basic adjustment settings

### Picture adjustments

You can adjust the picture to your preference.

Follow the steps to adjust the picture.

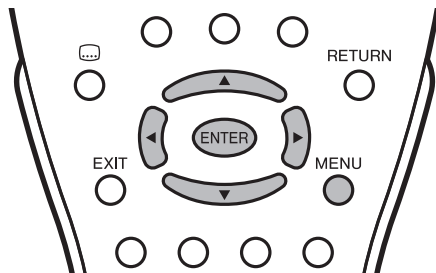

**1** Press **MENU** and the MENU screen displays.

**2** Press ◀▶ to select “Picture”.

**3** Press ▲/▼ to select a specific adjustment item.

**4** Press ◀▶ to adjust the item to your desired position.

#### NOTE

- For resetting all adjustment items to factory preset values, press ▲/▼ to select “Reset”, press **ENTER**, press ◀▶ to select “Yes”, and then press **ENTER**.

### Adjustments items

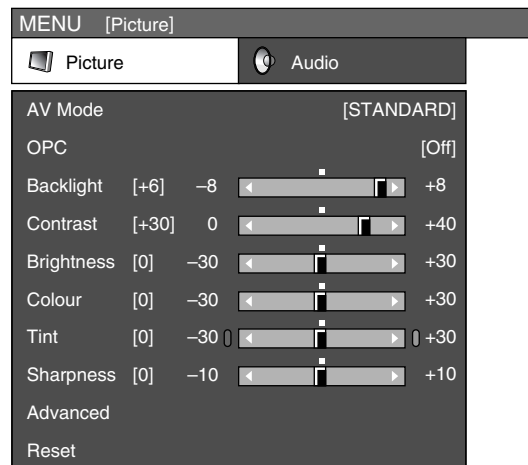

Selected item	◀ button	▶ button
<b>Backlight</b>	The screen dims	The screen brightens
<b>Contrast</b>	For less contrast	For more contrast
<b>Brightness</b>	For less brightness	For more brightness
<b>Colour</b>	For less colour intensity	For more colour intensity
<b>Tint</b>	Skin tones become purplish	Skin tones become greenish
<b>Sharpness</b>	For less sharpness	For more sharpness

#### NOTE

- Select “Advanced” and then press **ENTER** to set “Colour Temp.”, “Black”, “3D-Y/C”, “Monochrome”, “Film Mode” or “I/P Setting”. See pages 27 and 28.

## Basic adjustment settings

### Advanced

Advanced setting enables you to set the picture adjustment in more detail. There are six options you can choose from.

#### Colour temperature

Adjusts the colour temperature to give the best white image.

**1** Press **MENU** and the MENU screen displays.

**2** Press **◀/▶** to select "Picture".

**3** Press **▲/▼** to select "Advanced", and then press **ENTER**.

**4** Press **▲/▼** to select "Colour Temp.", and then press **ENTER**.

**5** Press **▲/▼** to select the desired level, and then press **ENTER**.

Selected item	Description
<b>High</b>	White with bluish tone ↑ ↓ White with reddish tone
<b>Mid-High</b>	
<b>Middle</b>	
<b>Mid-Low</b>	
<b>Low</b>	

### Black

For easier viewing, change the viewing depth by selecting a level for automatically adjusting the dark portion of an image.

**1** Repeat steps 1 to 3 in **Colour temperature**.

**2** Press **▲/▼** to select "Black", and then press **ENTER**.

**3** Press **◀/▶** to select "On", and then press **ENTER**.



Selected item	Description
<b>Off</b>	No adjustment
<b>On</b>	For high detail in black portions

### 3D-Y/C

Provides high quality images with minimal dot crawl and cross colour noise.

**1** Repeat steps 1 to 3 in **Colour temperature**.

**2** Press **▲/▼** to select "3D-Y/C", and then press **ENTER**.



**3** Press **▲/▼** to select the desired level, and then press **ENTER**.

Selected item	Description
<b>Off</b>	3D-Y/C off
<b>Standard</b>	Normal adjustment
<b>Fast</b>	For movie image
<b>Slow</b>	For still image

#### NOTE

- "3D-Y/C" is not selectable depending on the input signal type.
- 3D-Y/C may not operate depending on the input signal type or noisy input signal.

## Basic adjustment settings

### Monochrome

For viewing a video in monochrome.

- 1 Press **MENU** and the MENU screen displays.
- 2 Press **◀/▶** to select "Picture".
- 3 Press **▲/▼** to select "Advanced", and then press **ENTER**.
- 4 Press **▲/▼** to select "Monochrome", and then press **ENTER**.
- 5 Press **◀/▶** to select "On", and then press **ENTER**.

### Film mode

Automatically detects a film-based source (originally encoded at 24/25 frames/second, depending on the vertical frequency), analyses it then recreates each still film frame for high-definition picture quality.

- 1 Repeat steps 1 to 3 in **Monochrome**.
- 2 Press **▲/▼** to select "Film Mode", and then press **ENTER**.
- 3 Press **◀/▶** to select "On", and then press **ENTER**.

### I/P setting

Adjusting the image and input signal can give you a more beautiful picture.

- 1 Repeat steps 1 to 3 in **Monochrome**.
- 2 Press **▲/▼** to select "I/P Setting", and then press **ENTER**.
- 3 Press **◀/▶** to select "Interlace" or "Progressive", and then press **ENTER**.

#### NOTE

- The picture is progressive scan when Film Mode is "On".

### AV mode selection

This option links to "AV Mode" in the Picture menu. (See page 25.)

### Audio adjustment

For each AV position, you can adjust the following three items: Treble, Bass, and Balance; to your preferred setting.

After choosing the AV position you want to adjust, next carry out audio adjustment.

- 1 Press **MENU** and the MENU screen displays.

- 2 Press **◀/▶** to select "Audio".

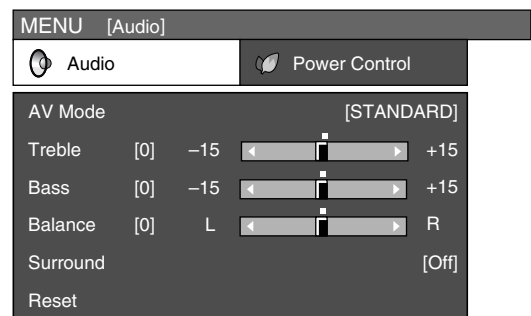

- 3 Press **▲/▼** to select a specific adjustment item.

- 4 Press **◀/▶** to adjust the item to your desired position.

Selected item	◀ button	▶ button
<b>Treble</b>	For weaker treble	For stronger treble
<b>Bass</b>	For weaker bass	For stronger bass
<b>Balance</b>	Decrease audio from the right speaker	Decrease audio from the left speaker

#### NOTE

- For resetting all adjustment items to factory preset values, press **▲/▼** to select "Reset", press **ENTER**, press **◀/▶** to select "Yes", and then press **ENTER**.
- Audio menu items other than "AV Mode" are greyed out when headphones are in use.

## Basic adjustment settings

### Surround

When you set to On, you can enjoy surround sound, the same as if you were in a movie theatre.

#### Using SURROUND on the remote control unit

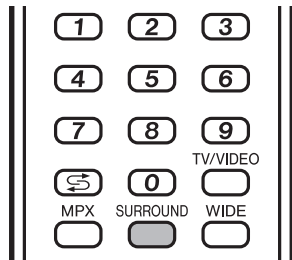

Press **SURROUND** to switch the Surround function on and off.

Selected item	Description
<b>On</b>	Makes it possible to enjoy natural, realistic surround sound.
<b>Off</b>	Outputs the normal sound.

#### Using Surround on the menu screen

You can produce Surround effects from the "Audio" setting.

**1** Press **MENU** and the MENU screen displays.

**2** Press **◀/▶** to select "Audio".

**3** Press **▲/▼** to select "Surround", and then press **ENTER**.

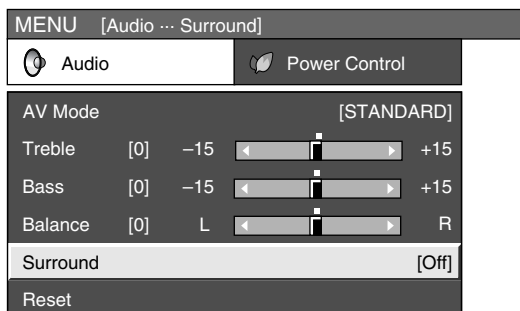

**4** Press **◀/▶** to select "On", and then press **ENTER**.

#### NOTE

- Audio menu items other than "AV Mode" are greyed out when headphones are in use.

### Power control

Power control setting allows you to save energy.

#### No Signal off

When set to "Enable", the power will automatically shut down if no signal inputs for 15 minutes.

**1** Press **MENU** and the MENU screen displays.

**2** Press **◀/▶** to select "Power control".  
• Power control menu displays.

**3** Press **▲/▼** to select "No Signal Off", and then press **ENTER**.

**4** Press **◀/▶** to select "Enable", and then press **ENTER**.  
• Five minutes before the power shuts down, remaining time displays every minute.

#### NOTE

- "Disable" is factory preset value.
- When a TV programme finishes, this function may not operate.

#### No Operation off

When set to "Enable", the power will automatically shut down if there is no operation for 3 hours.

**1** Press **MENU** and the MENU screen displays.

**2** Press **◀/▶** to select "Power control".  
• Power control menu displays.

**3** Press **▲/▼** to select "No Operation Off", and then press **ENTER**.

**4** Press **◀/▶** to select "Enable", and then press **ENTER**.  
• Five minutes before the power shuts down, remaining time displays every minute.

#### NOTE

- "Disable" is factory preset value.

# Useful adjustment settings

## Password setting for child lock (for TV input mode)

Allows you to use a password to protect certain settings from being accidentally changed.

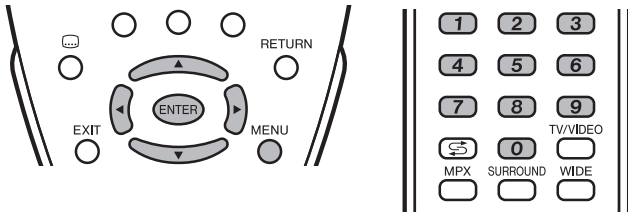

### Setting a password

Register a 4-digit password number to use the Child Lock function.

- 1 Press **MENU** and the MENU screen displays.
- 2 Press **◀/▶** to select "Setup".
- 3 Press **▲/▼** to select "Child Lock", and then press **ENTER**.
- 4 If you already set the password, enter it here.
- 5 Press **▲/▼** to select "Change password", and then press **ENTER**.

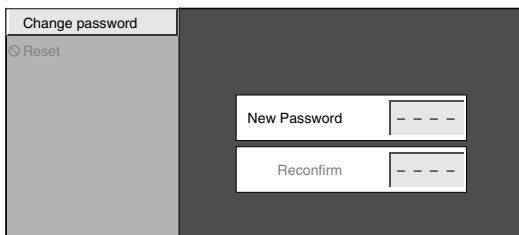

- 6 Enter the 4-digit number as a password using **0 – 9**.

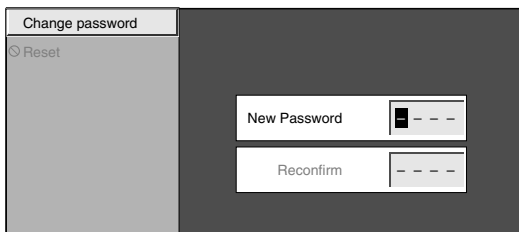

7

Enter the same 4-digit number as in step 6 to confirm.

- "The new password was registered." displays.

### NOTE

- To view a locked channel (Lock setting in Programme Setup "Manual Adjust" is set to "On"), you must enter a password. (See page 23.) When you select a locked channel, a password prompt message pops up. Press **ENTER** to display the password input window.

### Resetting the password

Allows you to reset your password.

- 1 Press **MENU** and the MENU screen displays.
- 2 Press **◀/▶** to select "Setup".
- 3 Press **▲/▼** to select "Child Lock", and then press **ENTER**.
- 4 Enter the password.
- 5 Press **▲/▼** to select "Reset", and then press **ENTER**.
- 6 Press **◀/▶** to select "Yes", and then press **ENTER**.

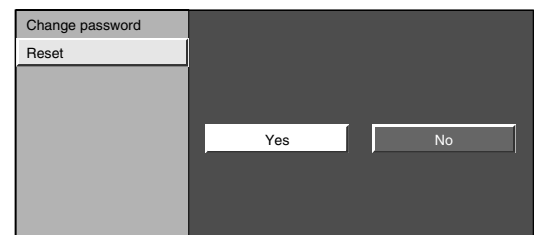

### NOTE

- **As a precautionary measure, make a note of your password and keep it in a familiar place. If you lose or forget your password, initialise the TV to return all settings except for the TV channel settings to factory preset values. (See page 47.)**
- This function is only available for TV input mode.
- To relock a channel which has been temporarily unlocked by inputting the correct password, turn power off and then on again.

## Useful adjustment settings

### Input Label

You can assign each input source a label you like.

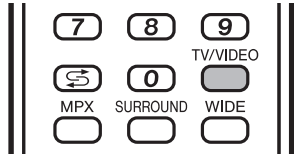

**1** Press **TV/VIDEO** to select the desired input source.

**2** Press **MENU** and the MENU screen displays.

**3** Press **◀/▶** to select “Setup”.

**4** Press **▲/▼** to select “Input Label”, and then press **ENTER**.

**5** Press **▲/▼/◀/▶** to select each character of the new name for the input source, and then press **ENTER**.

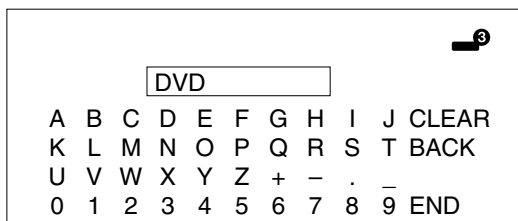

(Example)

**6** Repeat the above until the name is fully spelt out, and then press **ENTER**.

- The name can be 6 characters or less.
- When you want to set an input source name of less than 6 characters, select “END”, then press **ENTER** to exit from the labelling menu.

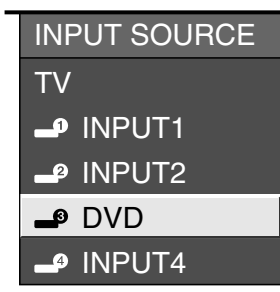

(Example)

#### NOTE

- You cannot change labels if the INPUT SOURCE is TV.

### Image position

For adjusting a picture's horizontal and vertical position.

**1** Press **MENU** and the MENU screen displays.

**2** Press **◀/▶** to select “Setup”.

**3** Press **▲/▼** to select “Position”, and then press **ENTER**.

**4** Press **▲/▼** to select “H-Pos.” or “V-Pos.”.

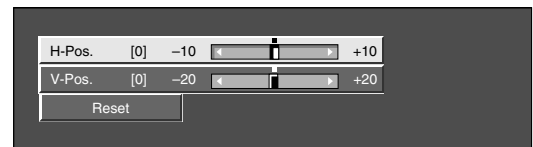

**5** Press **◀/▶** to adjust the item to your desired position.

Selected item	Description
H-Pos.	Centres the image by moving it to the left or right.
V-Pos.	Centres the image by moving it up or down.

#### NOTE

- For resetting all adjustment items to the factory preset values, press **▲/▼** to select “Reset”, and then press **ENTER**.
- **Adjustments are stored separately according to input source.**



## Useful adjustment settings

### Wide Screen Signalling (WSS)

WSS allows a television to switch automatically among the different screen formats.

**1** Press **MENU** and the MENU screen displays.

**2** Press **◀/▶** to select "Setup".

**3** Press **▲/▼** to select "WSS", and then press **ENTER**.

**4** Press **◀/▶** to select "On" or "Off", and then press **ENTER**.

#### NOTE

- Try to set WIDE mode if an image does not switch to the correct screen format. When the broadcast signal contains no WSS information, the function will not work even if enabled.

### Picture aspect ratio

The WSS signal has 4:3 auto-switching that allows you to select between Normal and Panorama.

**1** Press **MENU** and the MENU screen displays.

**2** Press **◀/▶** to select "Setup".

**3** Press **▲/▼** to select "4:3 Mode", and then press **ENTER**.

**4** Press **◀/▶** to select "Normal" or "Panorama", and then press **ENTER**.

#### WSS signal 4:3 screen

4:3 mode "Normal"



4:3 mode "Panorama"



Selected item	Description
<b>Normal</b>	Normal range keeping 4:3 or 16:9 aspect ratio
<b>Panorama</b>	Wide image without side bars

## Useful adjustment settings

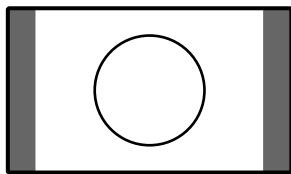
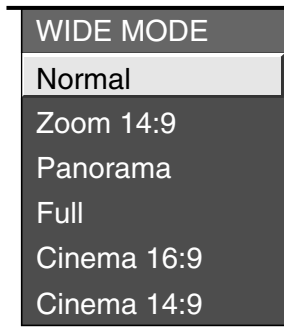
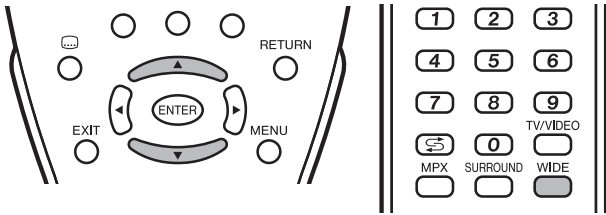

4:3 Mode set to "Normal"

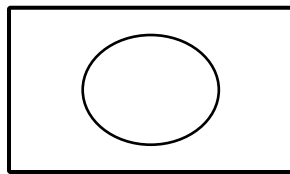

4:3 Mode set to "Panorama"

### WIDE mode

#### Manual Selection

1

Press **WIDE**.

- The WIDE MODE menu displays.
- The menu lists the wide mode options selectable for the type of video signal currently received.

2

Press **WIDE** or **▲/▼** while the WIDE MODE menu displays on the screen.

- As you toggle down the options, each is immediately reflected on the TV. No need to press **ENTER**.

#### Auto Selection

If you set "WSS" and "4:3 Mode" in the Setup menu on page 32, the optimum WIDE mode is automatically chosen for every broadcast containing the WSS information.

#### "WSS" menu

To enable Auto Selection, set "WSS" in the Setup menu to "On". (See page 32.)

#### "4:3 Mode" menu

To set the type of the wide screen, select "Normal" or "Panorama" in the 4:3 Mode menu. (See page 32.)

#### NOTE

- If the broadcast signal contains no WSS information, Auto Selection will not function even when the WSS option is enabled.

Selected item	Description
<b>Normal</b>	For 4:3 "standard" pictures. A side bar appears on each side.
<b>Zoom 14:9</b>	For 14:9 letterbox pictures. A thin side bar appears on each side, and you may also see bars on the top and bottom with some programmes.
<b>Panorama</b>	In this mode the picture is progressively stretched toward each side of the screen.
<b>Full</b>	For 16:9 squeeze pictures.
<b>Cinema 16:9</b>	For 16:9 letterbox pictures. Bars may appear on the top and bottom with some programmes.
<b>Cinema 14:9</b>	For 14:9 letterbox pictures. Bars may appear on the top and bottom with some programmes.

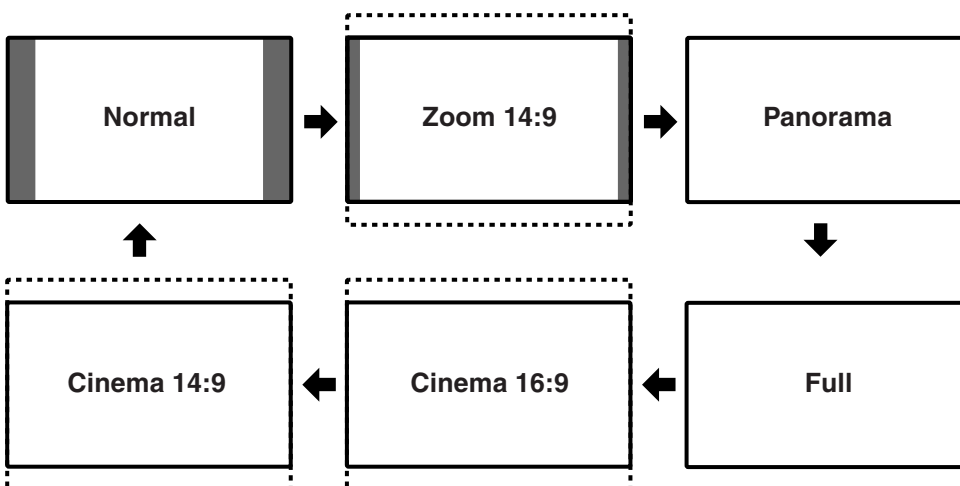

## Useful adjustment settings

### Rotate

You can set the image orientation to Mirror, Rotated or Upside down image.

[Normal]: normal image. [Mirror]: mirror image.

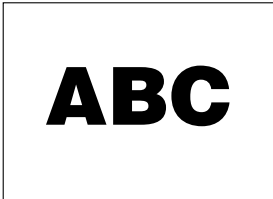

[Rotate]: rotated image. [Upside Down]: upside down image.

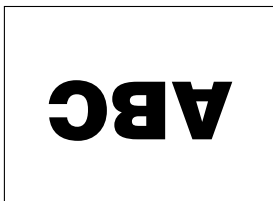

1 Press **MENU** and the MENU screen displays.

2 Press ◀/▶ to select "Setup".

3 Press ▲/▼ to select "Rotate", and then press **ENTER**.

4 Press ▲/▼ to select the desired mode, and then press **ENTER**.

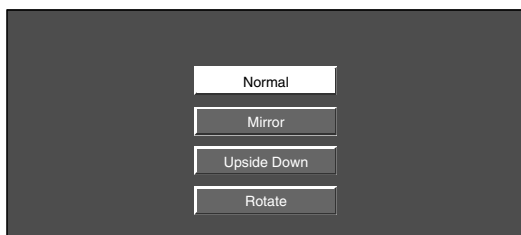

### Language setting for on-screen display

You can also select a language from setup menu. Select from among 3 languages: English, Chinese and Arabic.

1 Press **MENU** and the MENU screen displays.

2 Press ◀/▶ to select "Setup".

3 Press ▲/▼ to select "Language", and then press **ENTER**.

4 Press ▲/▼ to select the desired language listed on the screen, and then press **ENTER**.

## Useful adjustment settings

### Audio Only

When listening to music from a music programme, you can set the display off and enjoy audio only.

**1** Press **MENU** and the MENU screen displays.

**2** Press ◀/▶ to select "Option".

**3** Press ▲/▼ to select "Audio Only", and then press **ENTER**.

**4** Press ◀/▶ to select "On", and then press **ENTER**.

Selected item	Description
On	Audio is output without screen image.
Off	Both screen images and audio are output.

#### NOTE

- When you make operations that change the picture on the TV such as by changing the input source, the Audio Only function is set to "Off".

### DNR (Digital Noise Reduction)

Produces a clearer video image.

**1** Press **MENU** and the MENU screen displays.

**2** Press ◀/▶ to select "Option".

**3** Press ▲/▼ to select "DNR", and then press **ENTER**.

**4** Press ▲/▼ to select the desired level, and then press **ENTER**.



### HDMI Setup

HDMI (High-Definition Multimedia Interface) terminal selection.

**1** To watch an HDMI equipment image, select "INPUT4" from "INPUT SOURCE" menu using **TV/VIDEO** on the remote control unit or on the TV.

**2** Press **MENU** and the MENU screen displays.

**3** Press ◀/▶ to select "Option".

**4** Press ▲/▼ to select "HDMI Setup", and then press **ENTER**.

- The HDMI Setup menu is displayed only when "INPUT4" is selected from the INPUT SOURCE menu.

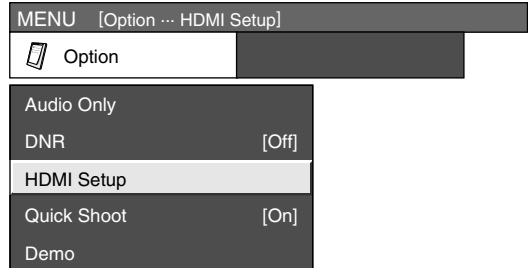

**5** Press ▲/▼ to select the desired item or setting, and then press **ENTER**.

HDMI Setup items	Selectable items	Description
<b>Signal Type</b>	RGB/YCbCr 4:4:4/ YCbCr 4:2:2	Select the video signal type from the HDMI terminal.
<b>Colour Matrix</b>	ITU601/ITU709	Select the internal colour space conversion method when an RGB signal is input.
<b>Dynamic Range</b>	Normal/ Enhanced	Select the signal amplitude range. Usually, select "Normal".
<b>Auto View</b>	Enable/Disable	Set whether or not to use WIDE MODE based on signal recognition, including an HDMI signal.
<b>Audio Select</b>	Digital/Analogue	Select "Digital" for audio signal via the HDMI terminal. Select "Analogue" for audio signal via the AUDIO jack.

#### NOTE

- Refer to your external equipment operation manual for the signal type.
- Items under "Signal Type", "Colour Matrix", and "Dynamic Range" can be selected when the equipment is connected with a DVI-HDMI conversion cable.
- When the equipment is connected with an HDMI cable, items are automatically set and cannot be selected.

## Useful adjustment settings

### Input Select

#### Selecting input source

Can use for selecting the input source.



**1** Press **TV/VIDEO** on the remote control unit or **TV/VIDEO** on the TV.

**2** Press **TV/VIDEO** on the remote control unit or **TV/VIDEO** on the TV to select the input source.

- An image from the selected source automatically displays.
- You can also select the input source by pressing **▲/▼**.

#### Selecting input signal type

For setting the signal type of external equipment.

**1** Press **MENU** and the MENU screen displays.

**2** Press **◀/▶** to select "Option".

**3** Press **▲/▼** to select "Input Select", and then press **ENTER**.

**4** Press **▲/▼** to select a signal type you want to set, and then press **ENTER**.

Input source	Selectable item
<b>INPUT 1</b>	AUTO, COMPONENT, VIDEO
<b>INPUT 2</b>	AUTO, COMPONENT, VIDEO
<b>INPUT 3</b>	AUTO, S-VIDEO, VIDEO

#### NOTE

- **If no (colour) image displays, try to change the other signal type.**
- Check the operation manual of the external equipment for the signal type.
- When the signal type is set to "AUTO", the input terminal where cable is connected is automatically selected.
- When the signal type is set to "AUTO" and multiple video signal cables are connected, the signal type is selected in the following prioritised order:  
Input 1/Input 2: COMPONENT → VIDEO  
Input 3: S-VIDEO → VIDEO

### Quick Shoot

Improves LCD response when viewing fast-moving images. The effect is greater at low room temperatures (at or below 15°C/59°F).

**1** Press **MENU** and the MENU screen displays.

**2** Press **◀/▶** to select "Option".

**3** Press **▲/▼** to select "Quick Shoot", and then press **ENTER**.

**4** Press **◀/▶** to select "On", and then press **ENTER**.

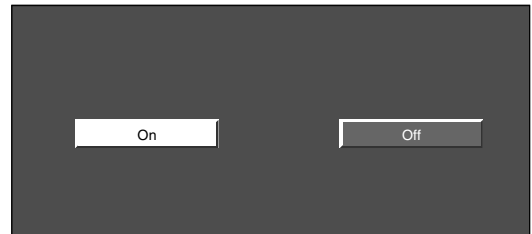

#### NOTE

- Quick Shoot may cause image noise. If this occurs, turn the function "Off".

## Useful adjustment settings

### Colour system setting

You can change the colour system to one that is compatible with the image on the screen.

**1** Press **MENU** and the MENU screen displays.

**2** Press **◀/▶** to select "Option".

**3** Press **▲/▼** to select "Colour System", and then press **ENTER**.

**4** Press **▲/▼** to select a compatible video signal system of your equipment, and then press **ENTER**.

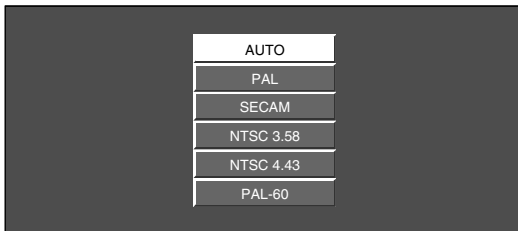

#### NOTE

- Factory preset value is "AUTO".
- If "AUTO" is selected, colour system for each channel is automatically set. If an image does not display clearly, select another colour system (e.g. PAL, NTSC 4.43).

### Demo

Demo shows some of the functions of the TV on the screen.

The demonstration items are as follows.

- Setting Demo to "On" or "Off".
- Selecting input source to use for Demo. (Demo, Skip [TV, INPUT1, INPUT2, INPUT3, INPUT4])
- Selecting Freeze setting for Demo. (On/Off)
- Selecting Menu setting for Demo. (On/Off)
- Selecting Interval setting for Demo. (10 Sec., 15 Sec., 30 Sec.)

#### NOTE

- The demo show can be activated from the option menu. After switching on this demo function, it takes 70 seconds approximately, before the TV-set starts the demo show. The selected functions are shown in a self-repeating sequence. Return to normal television-mode is possible only by deactivating the demo-function.

# Useful features

## Teletext language setting

If Teletext information does not display correctly, perform the setting procedure below.

Select from among 4 kinds of language tables: West Europe, East Europe, Greek/Turkish, Cyrillic.

Each table is compatible with the Teletext languages listed below.

**1** Press **MENU** and the MENU screen displays.

**2** Press ◀/▶ to select "Setup".

**3** Press ▲/▼ to select "Text Language", and then press **ENTER**.

**4** Press ▲/▼ to select receivable teletext broadcasting language in your country.

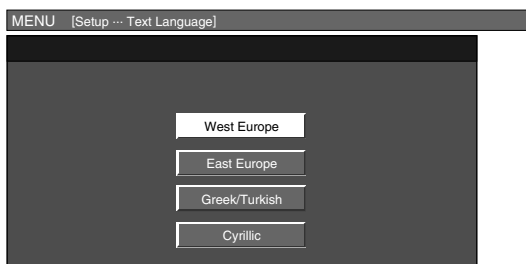

- West Europe - English, French, Scandinavian, Czech, German, Spanish, Italian
- East Europe - Polish, French, Scandinavian, Czech, German, Slovenian/Croatian, Italian, Rumanian
- Greek/Turkish - English, French, Scandinavian, Turkish, German, Spanish, Italian, Greek
- Cyrillic - English, Russian, Estonian, Czech, German, Spanish, Ukrainian, Lettish

### NOTE

- Teletext can display only when it is sent by a network. Not used to convert between languages.

## Useful features

### Teletext function

#### What is Teletext?



Teletext broadcasts pages of information and entertainment to specially equipped television sets. Your TV receives Teletext signals broadcast by a TV network, and decodes them into graphical format for viewing. News, weather reports, sports information, stock exchange prices and programme previews are among the many services available.

#### Teletext mode

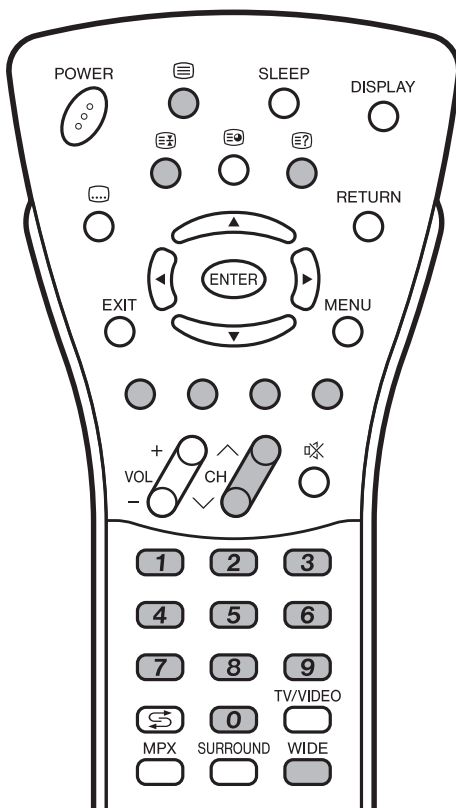
Teletext is turned on/off with  on the remote control unit. You can operate your TV in Teletext mode directly by inputting commands with the remote control unit.



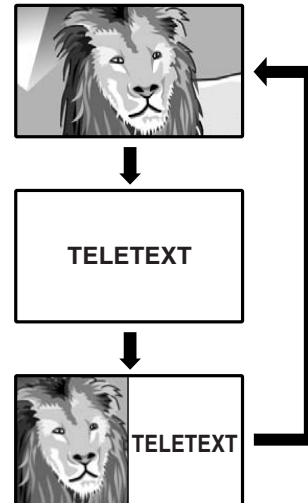

#### Turning on and off Teletext

- 1** Select a TV channel or external input source providing the Teletext programme.
- 2** Press  to display the Teletext.
- 3** Press  again to display the Teletext on the right screen and normal image on the left screen.
  - Each time you press , the screen switches as shown upper right.
  - If you select a programme with no Teletext signal, "No Teletext available." is displayed.
  - The same message displays during other modes if no Teletext signal is available.



#### When viewing the Teletext information

- Press **CH**  to increase the page number.
- Press **CH**  to decrease the page number.

#### Button functions

##### Colour (RED/GREEN/YELLOW/BLUE):

You can select a group or block of pages displayed in the coloured brackets at the bottom of the screen by pressing the corresponding **Colour (RED/GREEN/YELLOW/BLUE)** on the remote control unit.

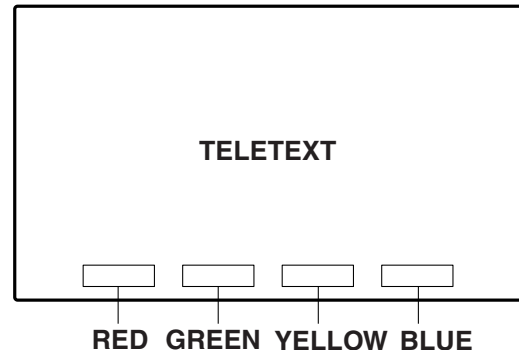

##### 0 - 9:

Directly select any page from 100 to 899 by using **0 - 9**.

##### WIDE:

Each time you press **WIDE**, the TELETEXT image switches as shown below.

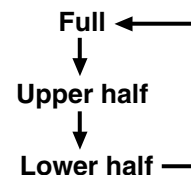

##### :

To reveal hidden information such as an answer to a quiz, press .

- Press  again to hide the information.

##### :

To stop updating Teletext pages automatically, press .

- Press  again to release the hold mode.



## Useful features

### Displaying Subtitle

You can display several subtitles as they are transmitted.

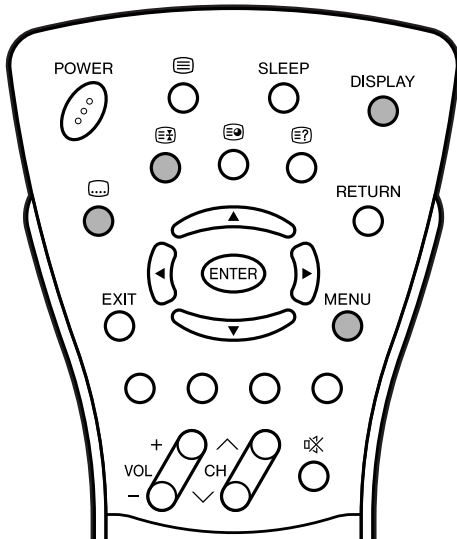

- 1 Press to display the subtitle.
  - Subtitle is updated by information sent by the broadcasting station.
  - To stop updating subtitle automatically, press .

- 2 Press to exit the subtitle screen.

#### NOTE

- Subtitle will not be displayed when the service does not contain the subtitle information.

### Time display

You can display the time information included in the Teletext broadcast.

- 1 Select a TV channel providing Teletext information. (The time information is automatically captured.)
- 2 Press **DISPLAY**. The channel display will appear on the display.
- 3 Press **DISPLAY** again within the three-second interval the channel display is on the screen. Time information will display on the lower left of the screen for about three seconds.
- 4 Even when you change the TV channel, you can display the time information with steps 2 to 3 above.

#### NOTE

- The time display cannot be stored once the power is turned off. When you turn on the power, perform steps 1 to 4 again.
- If acquired successfully the time information will appear in the upper-right corner of the screen by pressing **MENU**.

### Displaying Subpages

You can display several subpages as they are transmitted.

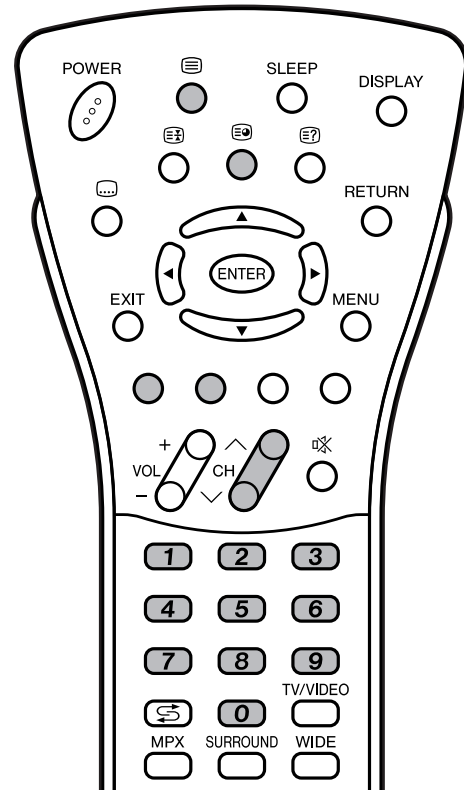

- 1 Press to display Teletext.

- 2 Press to display the subpage as shown below.

#### Subpage screen

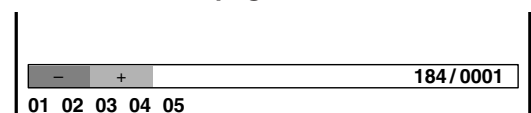

- 3 Select the desired subpage by using **CH**/**^**/**CH**/**∇**, **RED** or **GREEN**.
  - **0 – 9** directly selects the desired subpage.
- 4 Press to exit the subpage screen.

# Using external equipment

You can connect many types of external equipment to your TV, like a VCR, DVD player, HDTV tuner, game console and camcorder. To view external source images, select the input source from **TV/VIDEO** on the remote control unit or **TV/VIDEO** on the TV.

## Displaying an external equipment image

Explanation here is for the setting when connecting DVD to INPUT1 terminal.

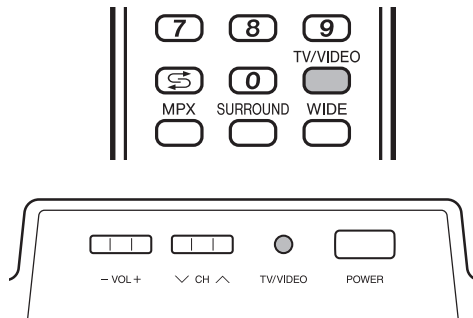

## Displaying a DVD image (Example)

1

To watch a DVD image, select "INPUT1" from "INPUT SOURCE" menu using **TV/VIDEO** on the remote control unit or **TV/VIDEO** on the TV.

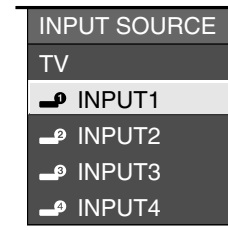

### CAUTION

- To protect all equipment, always turn off the TV before connecting to a VCR, DVD player, HDTV tuner, game console, camcorder or other external equipment.

### NOTE

- See pages 41 to 43 for external equipment connection.
- Please refer to the relevant operation manual (VCR, DVD player, etc.) carefully before making connections.
- Each time **TV/VIDEO** is pressed, the input source toggles.
- If the image does not come in clearly, you may need to change the input signal type setting on the "Input Select" menu.
- Refer to your external equipment operation manual for the signal type.

2

Select the desired signal type on "Input Select" in the "Option" menu. (See page 36.)

### For INPUT1 signal

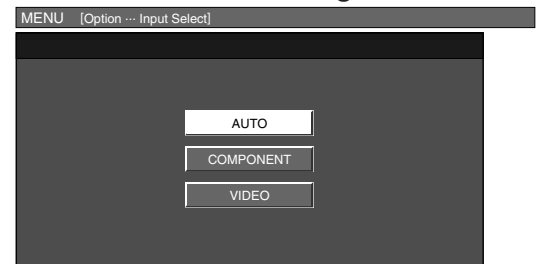

The setting is stored and can be selected on the "INPUT SOURCE" menu.

## Connecting a VCR

You can use the INPUT 3 terminal when connecting a VCR and other audiovisual equipment.

To watch an image from this input terminal, you need to select the input source (see page 41) and the input signal type (see page 36).

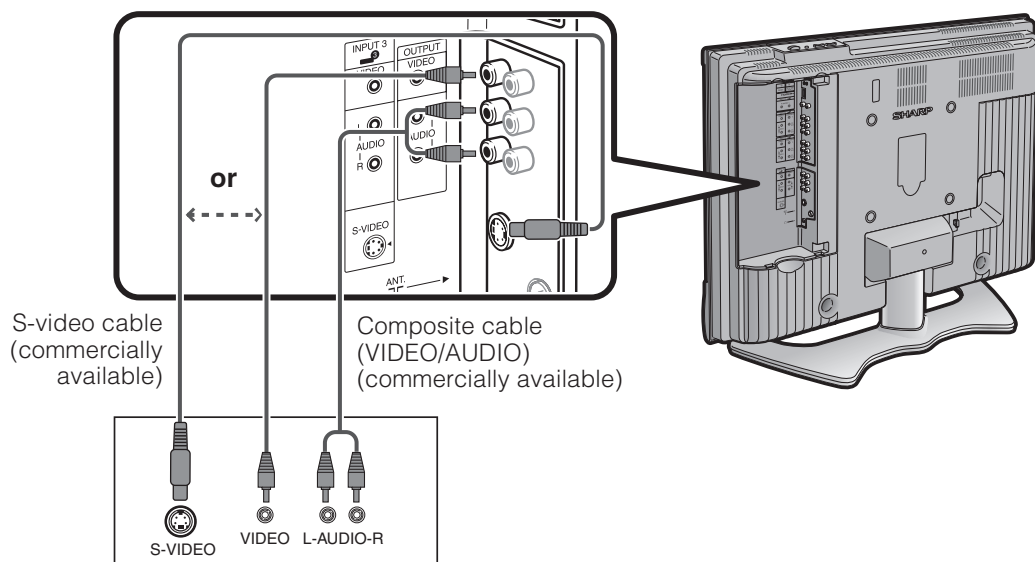

VCR

## Using external equipment

### Connecting a DVD player

You can use the INPUT 1 or INPUT 4 (HDMI) terminal when connecting to a DVD player and other audiovisual equipment.

#### NOTE

- When using an HDMI-DVI conversion adapter, input the Audio Signal from the AUDIO terminal of INPUT 4.

To watch an image from this input terminal, you need to select the input source (see page 41) and the input signal type (see page 36).

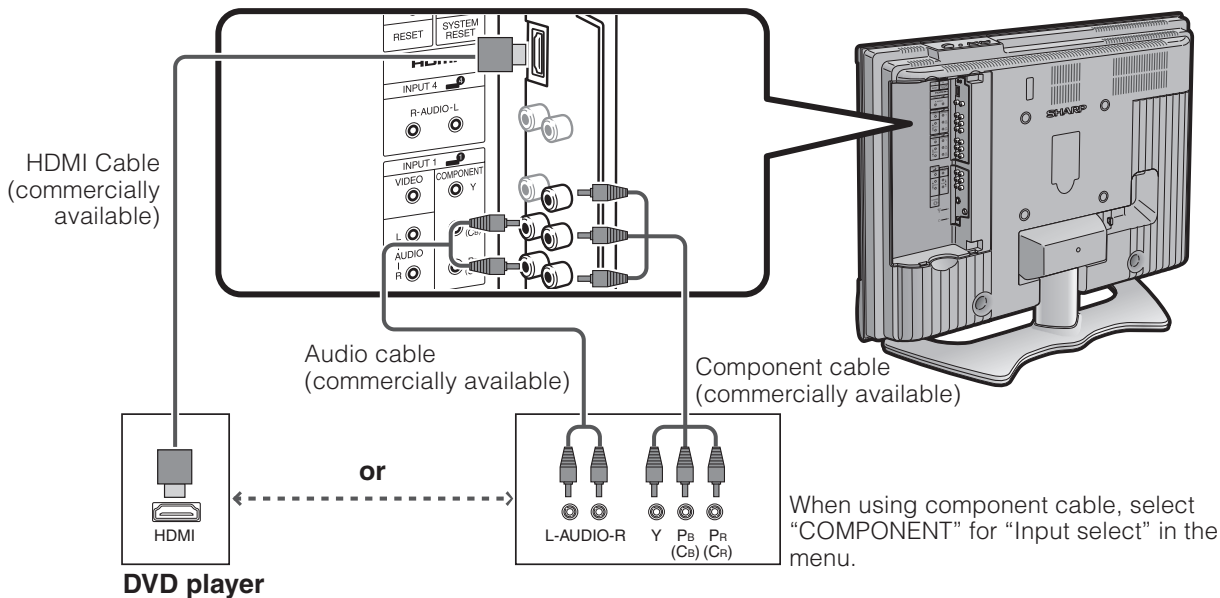

### Connecting a game console or camcorder

A game console, camcorder and some other audiovisual equipment are conveniently connected using the INPUT 3 terminals.

#### NOTE

- The S-video terminal has priority over the video terminals.
- You can also connect the game console to INPUT 1 or 2 terminals to enjoy clearer picture.

To watch an image from this input terminal, you need to select the input source (see page 41) and the input signal type (see page 36).

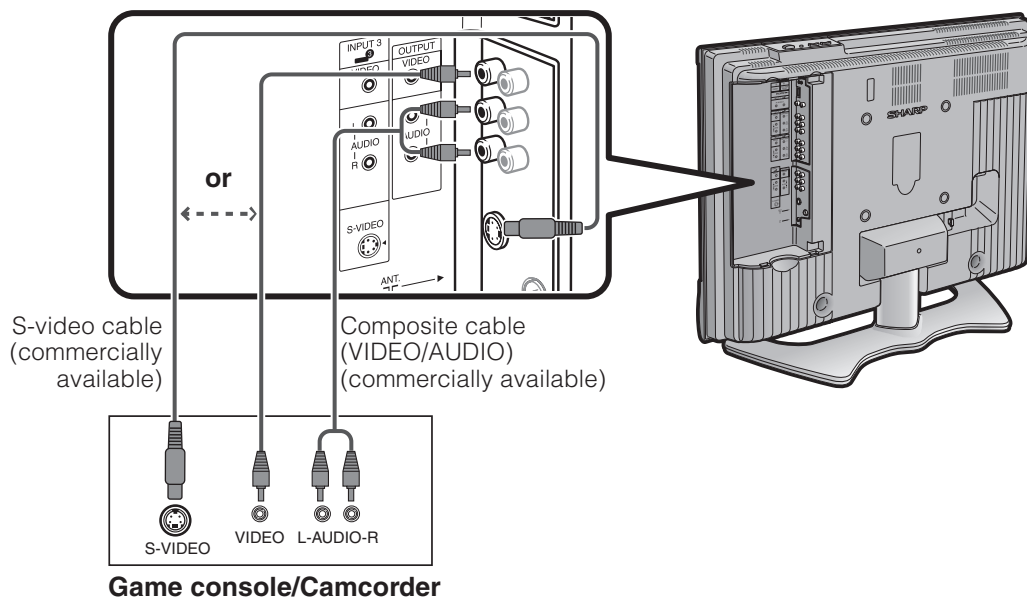

## Using external equipment

### Connecting an HDTV tuner

You can use the INPUT 2 terminal when connecting to an HDTV tuner and other audiovisual equipment.

To watch an image from this input terminal, you need to select the input source (see page 41) and the input signal type (see page 36).

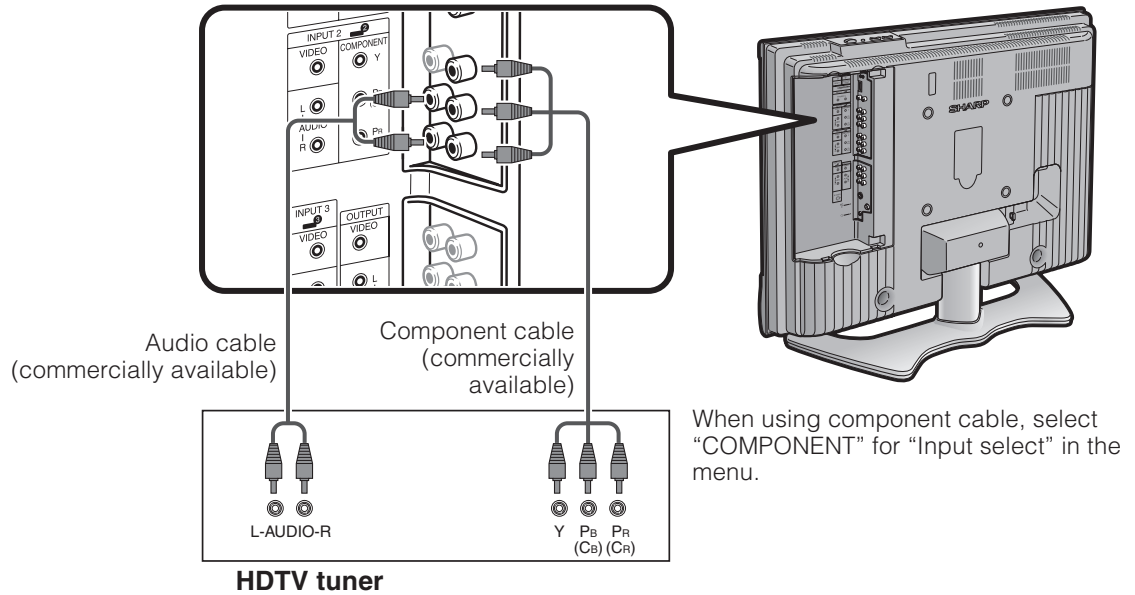

# Appendix

## Troubleshooting

Problem	Possible Solution
<ul style="list-style-type: none"> <li>No power.</li> </ul>	<ul style="list-style-type: none"> <li>Check if you pressed <b>POWER</b> on the remote control unit. (See page 14.) If the indicator on the TV lights up red, press <b>POWER</b>.</li> <li>Is the AC cord disconnected? (See page 7.)</li> <li>Has the power been turned on? (See page 14.)</li> </ul>
<ul style="list-style-type: none"> <li>Unit cannot be operated.</li> </ul>	<ul style="list-style-type: none"> <li>External influences such as lightning, static electricity, etc., may cause improper operation. In this case, operate the unit after first turning the power off the TV or unplugging the AC cord and re-plugging it in after 1 or 2 minutes.</li> </ul>
<ul style="list-style-type: none"> <li>Remote control unit does not operate.</li> </ul>	<ul style="list-style-type: none"> <li>Are batteries inserted with polarity (+, -) aligned? (See page 6.)</li> <li>Are batteries worn out? (Replace with new batteries.)</li> <li>Are you using it under strong or fluorescent lighting?</li> <li>Is a fluorescent light illuminated to remote control sensor?</li> </ul>
<ul style="list-style-type: none"> <li>Picture is cut off.</li> </ul>	<ul style="list-style-type: none"> <li>Is the image position correct? (See page 31.)</li> <li>Are screen mode adjustments such as picture size made correctly? (See pages 32 and 33.)</li> </ul>
<ul style="list-style-type: none"> <li>Strange colour, light colour, or dark, or colour misalignment.</li> </ul>	<ul style="list-style-type: none"> <li>Adjust the picture tone. (See pages 26 to 28 and 35.)</li> <li>Is the room too bright? The picture may look dark in a room that is too bright.</li> <li>Check the colour system setting. (See pages 22 and 37.)</li> <li>Check the input signal setting. (See page 36.)</li> </ul>
<ul style="list-style-type: none"> <li>Power is suddenly turned off.</li> </ul>	<ul style="list-style-type: none"> <li>The unit's internal temperature has increased. Remove any objects blocking vent or clean.</li> <li>Check the power control setting. (See page 29.)</li> <li>Is sleep timer set? (See page 17.)</li> </ul>
<ul style="list-style-type: none"> <li>No picture.</li> </ul>	<ul style="list-style-type: none"> <li>Is connection to other equipment correct? (See pages 41 to 43)</li> <li>Has input signal setup been done correctly after connection? (See page 36.)</li> <li>Is the correct input selected? (See page 36.)</li> <li>Is picture adjustment correct? (See pages 26 to 28.)</li> <li>Is the antenna connected properly? (See page 9.)</li> <li>Is "On" selected in "Audio Only"? (See page 35.)</li> </ul>
<ul style="list-style-type: none"> <li>No sound.</li> </ul>	<ul style="list-style-type: none"> <li>Is the volume too low? (See page 17.)</li> <li>Make sure that headphones are not connected. (See page 12.)</li> </ul>

### Cautions regarding use in high and low temperature environments

- When the unit is used in a low temperature space (e.g. room, office), the picture may leave trails or appear slightly delayed. This is not a malfunction, and the unit will recover when the temperature returns to normal.
- Do not leave the unit in a hot or cold location. Also, do not leave the unit in a location exposed to direct sunlight or near a heater, as this may cause the cabinet to deform and the LCD panel to malfunction.  
Storage temperature: -20°C to +60°C.

## Appendix

### Specifications

Item		Model	LC-32AX3X	LC-37AX3X
LCD panel			32" (80 cm) Advanced Super View & BLACK TFT LCD	37" (94 cm) Advanced Super View & BLACK TFT LCD
Number of dots			3,147,264 dots (1366 × 768 × 3 dots)	
Video Colour System			PAL/SECAM/NTSC 3.58/NTSC 4.43/PAL 60	
TV Function	TV-Standard		PAL: B/G, D/K, I SECAM: B/G, D/K, K/K <sub>1</sub> NTSC: M	
	Receiving Channel	VHF/UHF	44.25-863.25 MHz	
		CATV	S1-S41ch (including Hyperband)	
	TV-Tuning System		Auto Preset 99 ch	
STEREO/BILINGUAL			NICAM: B/G, I, D/K A2 stereo: B/G	
Brightness			450 cd/m <sup>2</sup>	
Backlight life			60,000 hours (at Backlight Standard position)	
Viewing angles			H : 170° V : 170°	
Audio amplifier			10W × 2	
Speakers			Ø 8 cm 2pcs	
Terminals	ANTENNA IN		UHF/VHF 75 Ω Din type	
	INPUT 1		VIDEO in, AUDIO in, COMPONENT in	
	INPUT 2		VIDEO in, AUDIO in, COMPONENT in	
	INPUT 3		VIDEO in, AUDIO in, S-VIDEO in	
	INPUT 4		HDMI (HDMI input), AUDIO in	
	AV OUTPUT		VIDEO out, AUDIO out	
	Headphones		Ø 3.5mm jack (Audio output)	
OSD language			English/Chinese/Arabic	
Power Requirement			AC 110-240 V, 50 Hz	
Power Consumption			123 W (0.6 W Standby) (Method IEC60107)	147 W (0.6 W Standby) (Method IEC60107)
Weight			15.7 kg (without stand) 21.5 kg (with stand)	19.0 kg (without stand) 24.8 kg (with stand)
Operating Temperature			0°C - 40°C	

- As a part of policy of continuous improvement, SHARP reserves the right to make design and specification changes for product improvement without prior notice. The performance specification figures indicated are nominal values of production units. There may be some deviations from these values in individual units.

### Optional accessory

The listed optional accessory is available for the LCD colour TV. Please purchase it at your nearest shop.

- Additional optional accessories may be available in the near future. When purchasing, please read the newest catalogue for compatibility and check the availability.

Part name	Part number
Wall mount bracket (for LC-32AX3X/ LC-37AX3X)	AN-37AG2

# Dimensional drawings

LC-32AX3X, LC-37AX3X

Unit: mm

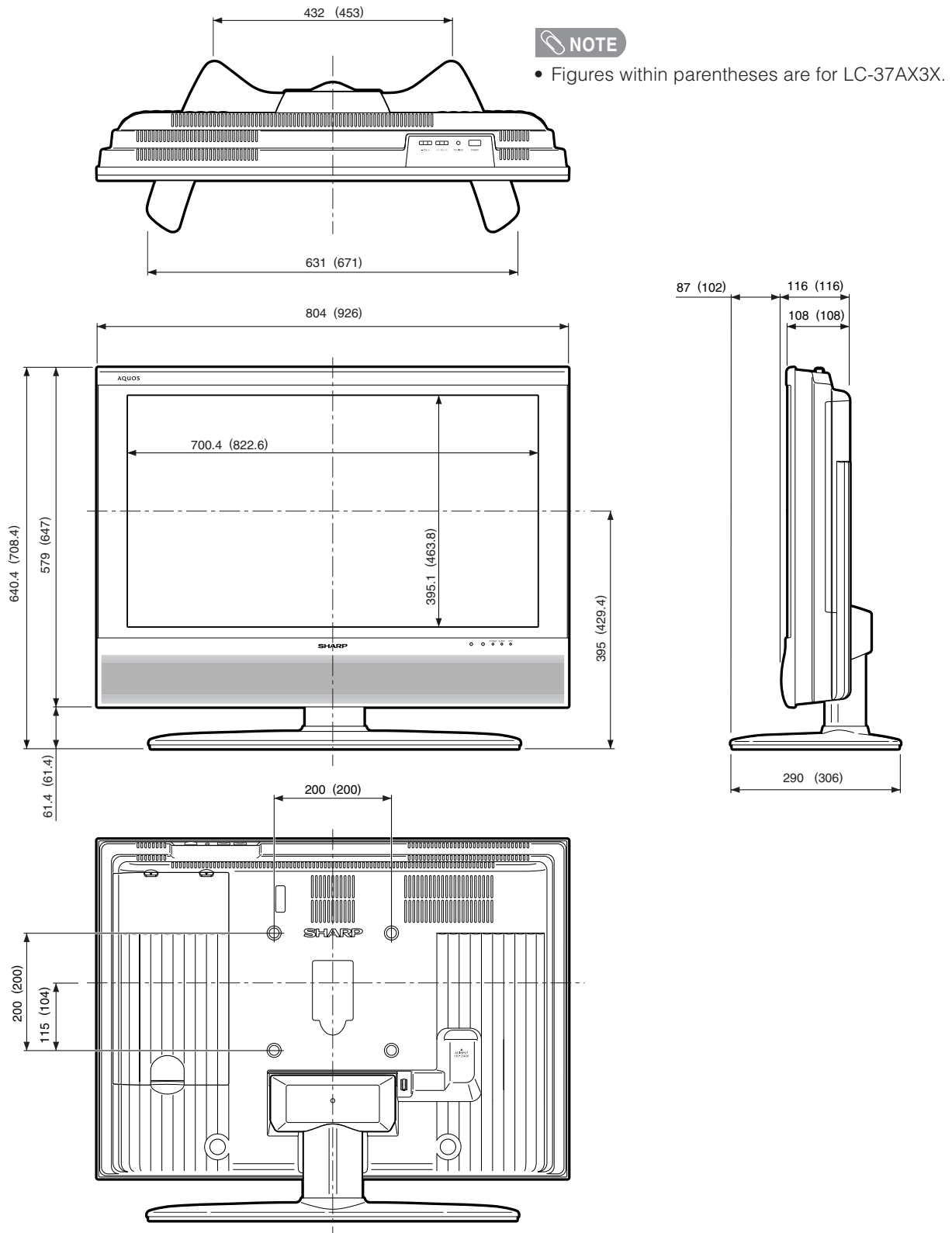

## HOW TO SET THE FACTORY PRESETS

Turn off the TV by pressing **POWER** on the TV.

After waiting for about 1 minute, press and hold down **RESET** and press **POWER** on the TV to turn on the TV. All setting items (except TV channel) return to the factory presetting.

### NOTE

- Password will be cleared after running the factory presetting operation.

You can run the Auto Installation again by using the following steps.

- 1** Turn on the power of the TV.
- 2** Press **MENU**. (Make sure the menu screen displays.)
- 3** Press ◀/▶ to select "Setup".
- 4** Press ▲/▼ to select "Auto Installation", and then press **ENTER**.
- 5** Press ◀/▶ to select "Yes", and then press **ENTER**.



The Password is

--	--	--	--

### NOTE

- As a precautionary measure, make a note of your password above, scissor it from this manual, and keep it in a familiar place.



**SHARP**

FOR LOCATION ENQUIRIES WITHIN

**AUSTRALIA**

REGARDING YOUR LOCAL

**SHARP APPROVED SERVICE CENTRE**

VISIT OUR WEBSITE AT

**[www.sharp.net.au](http://www.sharp.net.au)**

OR CALL SHARP CUSTOMER CARE

**1300 135 022**

(LOCAL CALL COST APPLY WITHIN AUSTRALIA)

SHARP CORPORATION OF AUSTRALIA PTY LTD

**SHARP**

FOR LOCATION ENQUIRIES WITHIN

**NEW ZEALAND**

REGARDING YOUR LOCAL

**SHARP APPROVED SERVICE CENTRE**

VISIT OUR WEBSITE AT

**[www.sharp.net.nz](http://www.sharp.net.nz)**

CONTACT YOUR SELLING DEALER/RETAILER

OR CALL

**SHARP CUSTOMER SERVICES**

TELEPHONE: 09 573 0111

FACSIMILE: 09 573 0113

SHARP CORPORATION OF NEW ZEALAND LIMITED

# SHARP

## WARRANTY

### *Consumer Electronic Products*

#### Congratulations on Your Purchase!

This Sharp product is warranted against faults in materials and manufacture for a period of twelve (12) months from the date of original purchase.

If service is required during the warranty period, please contact your nearest Sharp Approved Service Centre. These repairs would be carried out at no charge to the owner, subject to the conditions specified herein.

The owner is responsible for any transportation and insurance costs if the product has to be returned for repair.

This warranty does not extend to accessories or defects or injuries caused by or resulting from causes not attributable to faulty parts or the manufacture of the product, including but not limited to, defect or injury caused by or resulting from misuse, abuse, neglect, accidental damage, improper voltage, liquid spillage, vermin infestation, software, or any alterations made to the product which are not authorised by Sharp.

Please retain your sales documentation, as this should be produced to validate a warranty claim.

This warranty is in addition to and in no way limits, varies or excludes any express and implied rights and remedies under any relevant legislation in the country of sale.

#### IMPORTANT

#### DO NOT RETURN THIS DOCUMENT TO SHARP

For your reference, please enter the particulars of your purchase below and retain, with your purchase documentation.

Model No. \_\_\_\_\_

Serial No. \_\_\_\_\_

Date of Purchase \_\_\_\_\_

Retailer \_\_\_\_\_

# SHARP

SHARP CORPORATION OF  
AUSTRALIA PTY. LIMITED  
ABN 40 035 039 405  
1 Huntingwood Drive  
Huntingwood NSW2148

SHARP CORPORATION OF  
NEW ZEALAND LIMITED  
59 Hugo Johnston Drive  
Penrose, Auckland

SPform030 (JUNE 2004)

IMPORTANT NOTICE: This warranty applies only to products sold in Australia & New Zealand

# SHARP®

## SHARP CORPORATION



Printed on 100% post-consumer recycled paper.

Printed in Japan  
TINS-C159WJZZ  
05P12-JA-MG