



Illustrated Parts List

Model Series

217800

TYPE NUMBER
0111 through 0665.

TABLE OF CONTENTS

Air Cleaner	7
Alternator	10
Blower Housing	7
Camshaft	3
Carburetor	5, 6
Controls	9
Crankshaft	3
Cylinder	2
Cylinder Head	4
Electric Starter	8
Engine Sump	2
Exhaust System	7
Flywheel	8
Fuel System	9
Gasket Set - Engine	4
Gasket Set - Valve	4
Governor Spring	9
Ignition	9
Intake Manifold	4
Kit - Carburetor Overhaul	5
Lubrication	3
Operator's Manual	2
Piston, Rings, Connecting Rod	3
Rewind Starter	8
Valves	4
Warning Label	2

PRINTED IN U.S.A.



COPYRIGHT by BRIGGS & STRATTON CORPORATION
All rights reserved. No part of this material may be reproduced or transmitted,
in any form or by any means, electronic or mechanical, including photocopying,
recording or by any information storage and retrieval system, without permission
in writing from Briggs & Stratton Corporation.

1058 OPERATOR'S MANUAL

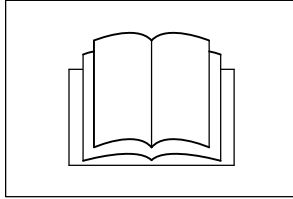

1319 WARNING LABEL

WARNING

- Read and follow Operating Instructions before running engine.
- Gasoline is flammable. Allow engine to cool at least 2 minutes before refueling.
- Engines emit carbon monoxide, **DO NOT** run in enclosed area.
- Muffler area temperature may exceed 150°F. Do not touch hot parts.

REQUIRED when replacing parts with warning labels affixed.

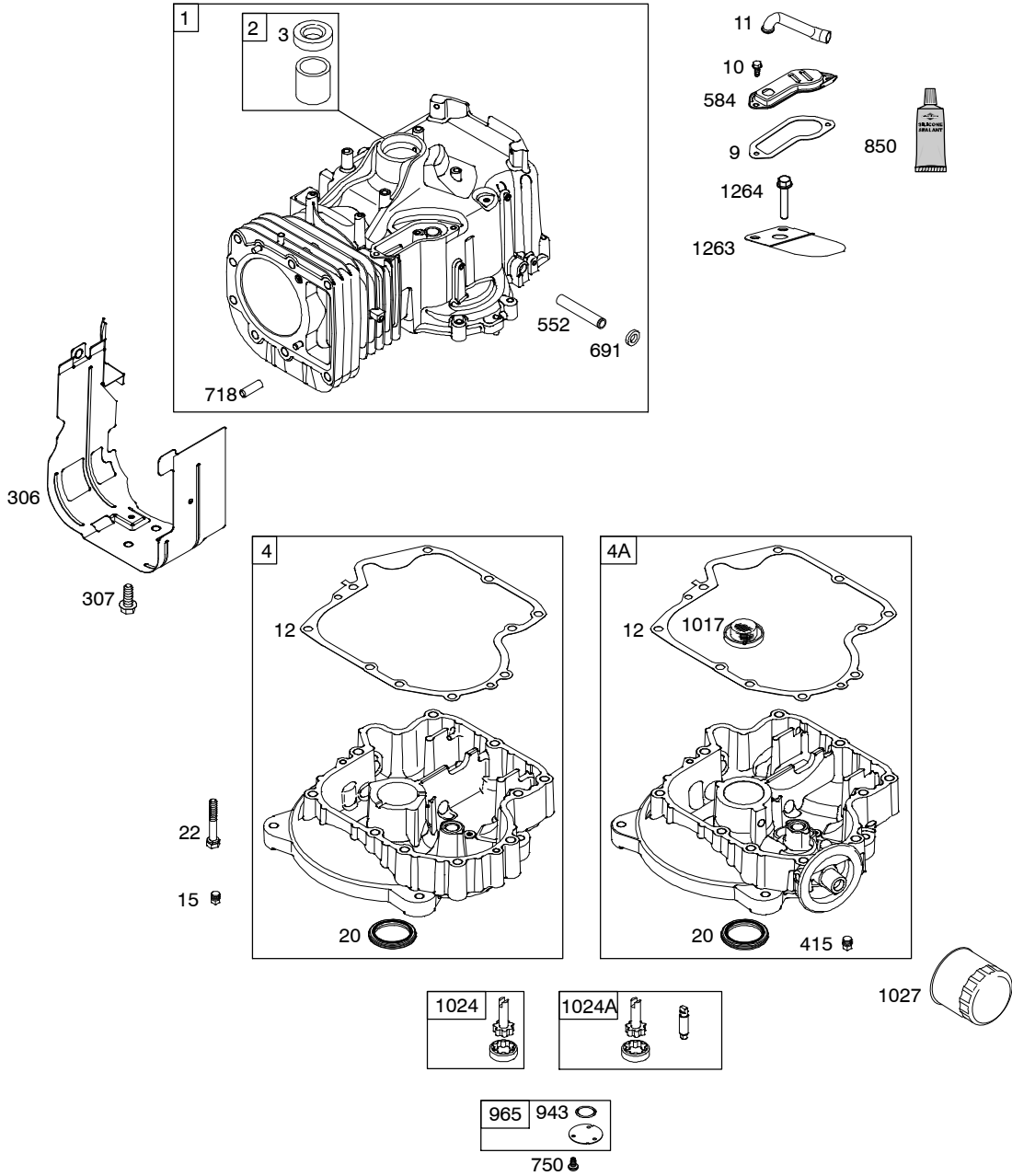

Illustrations cover a range of engines. Parts shown without corresponding text may not be used on your specific engine.

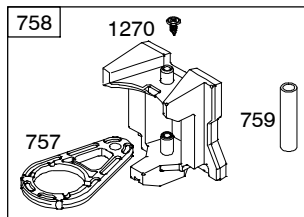
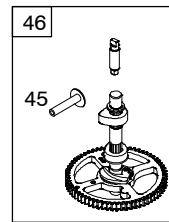
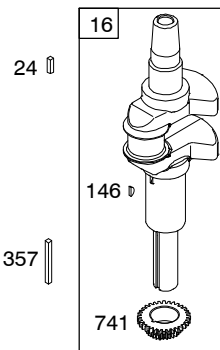
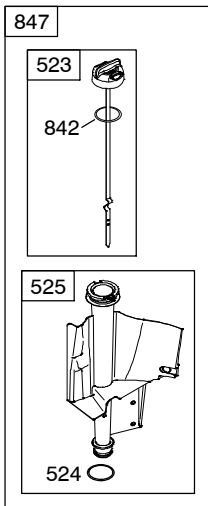
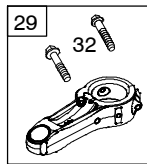
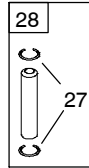
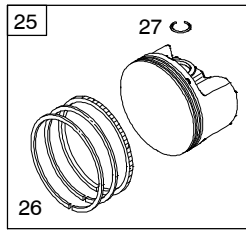

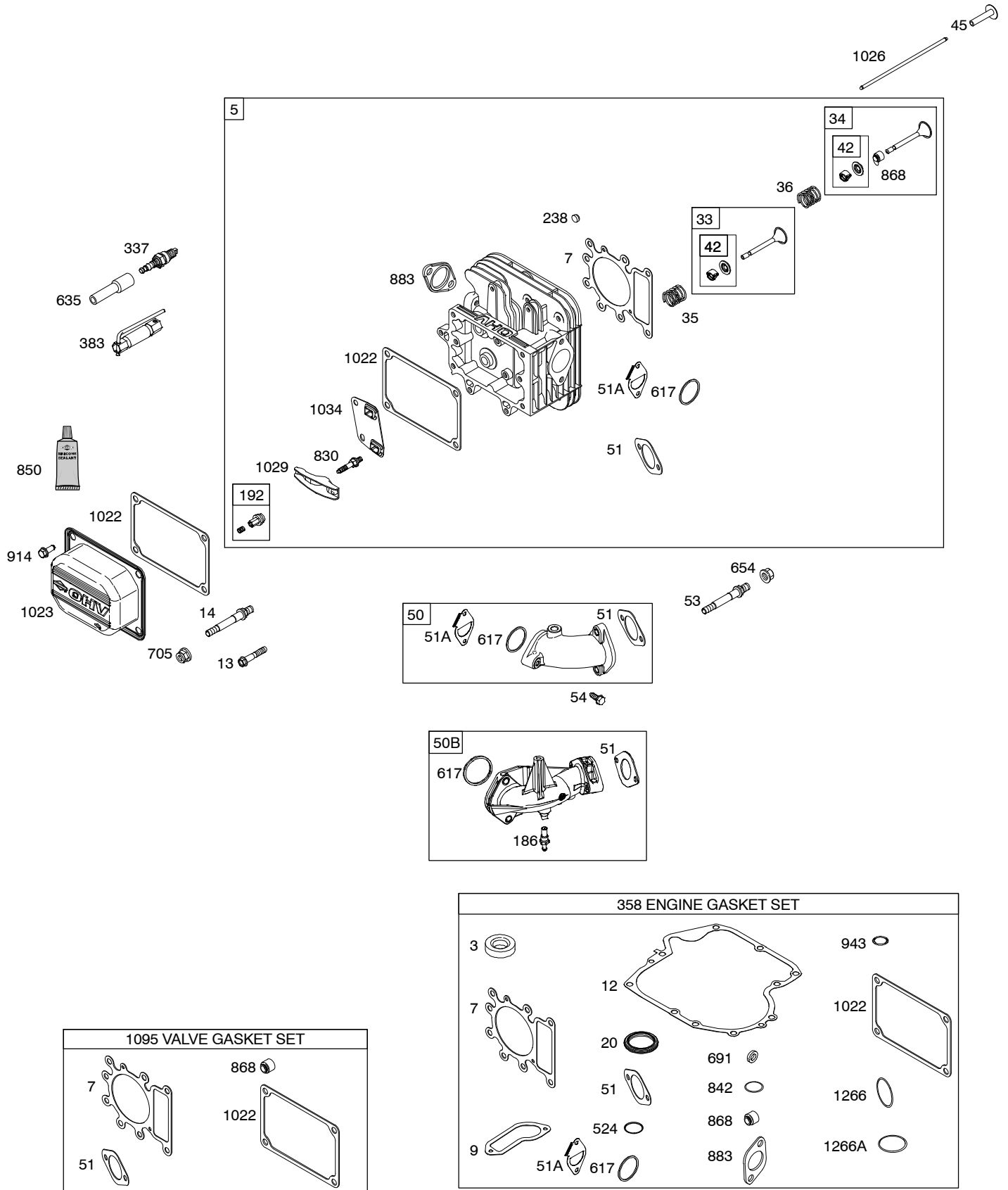

Illustrations cover a range of engines. Parts shown without corresponding text may not be used on your specific engine.

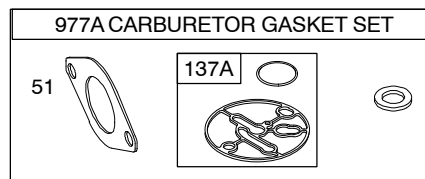
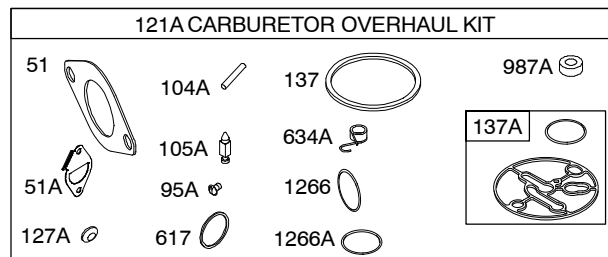
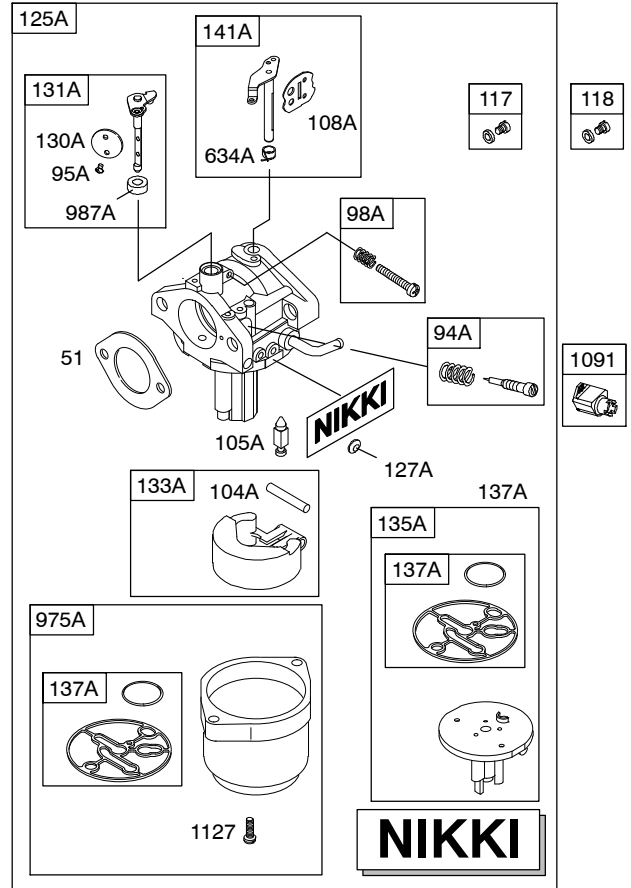

Illustrations cover a range of engines. Parts shown without corresponding text may not be used on your specific engine.

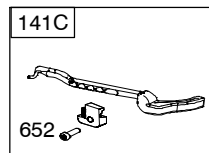
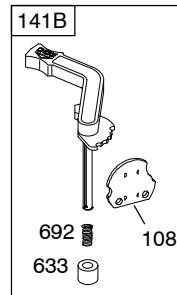
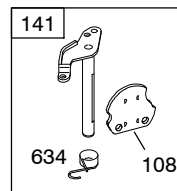
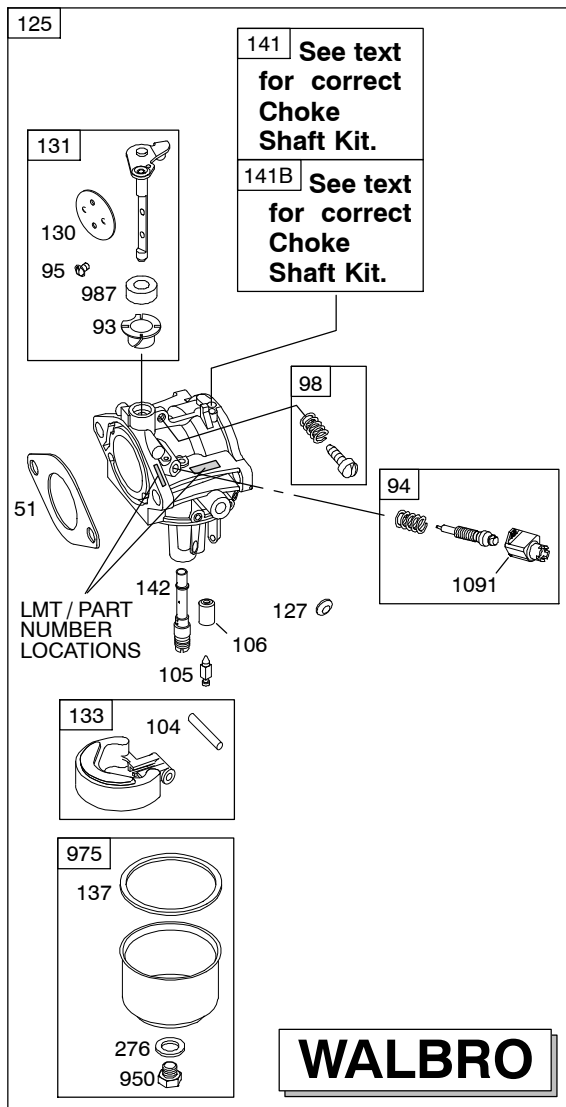
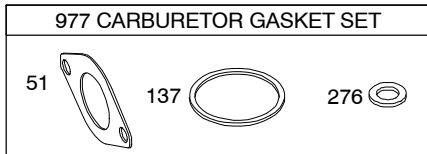
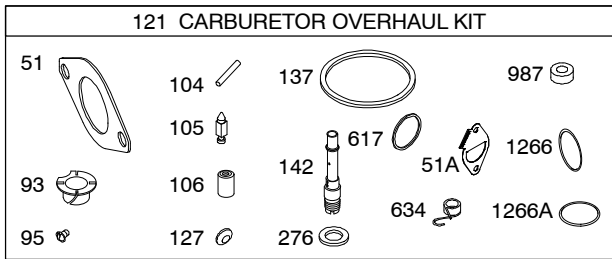

Illustrations cover a range of engines. Parts shown without corresponding text may not be used on your specific engine.

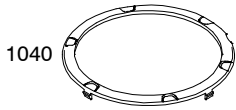

1036 EMISSIONS LABEL

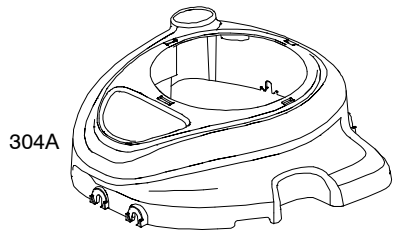
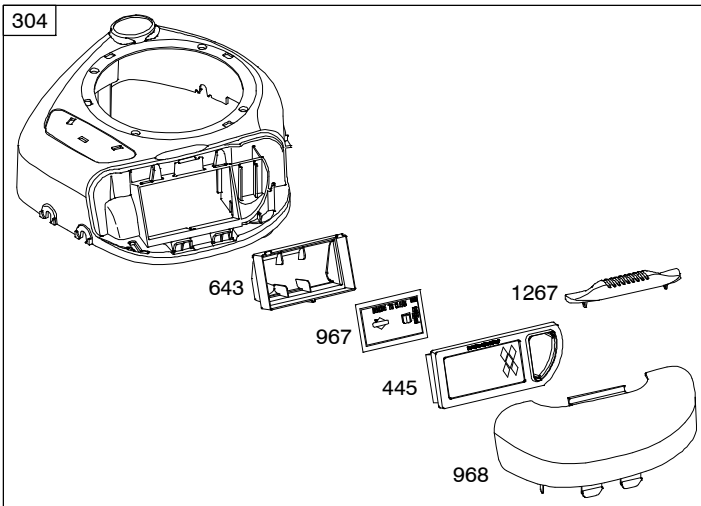

305A
305

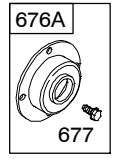
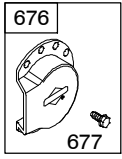
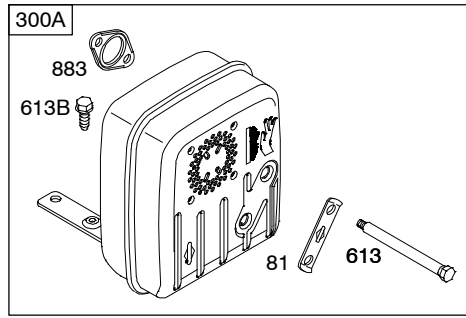
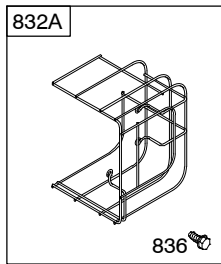
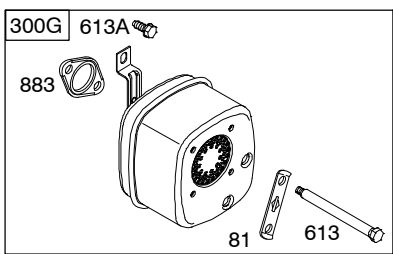
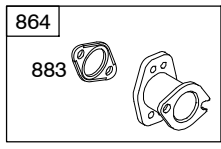
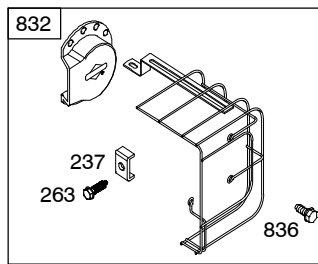
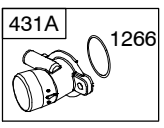
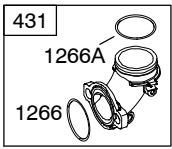
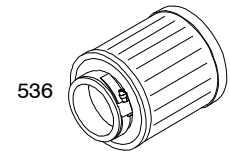



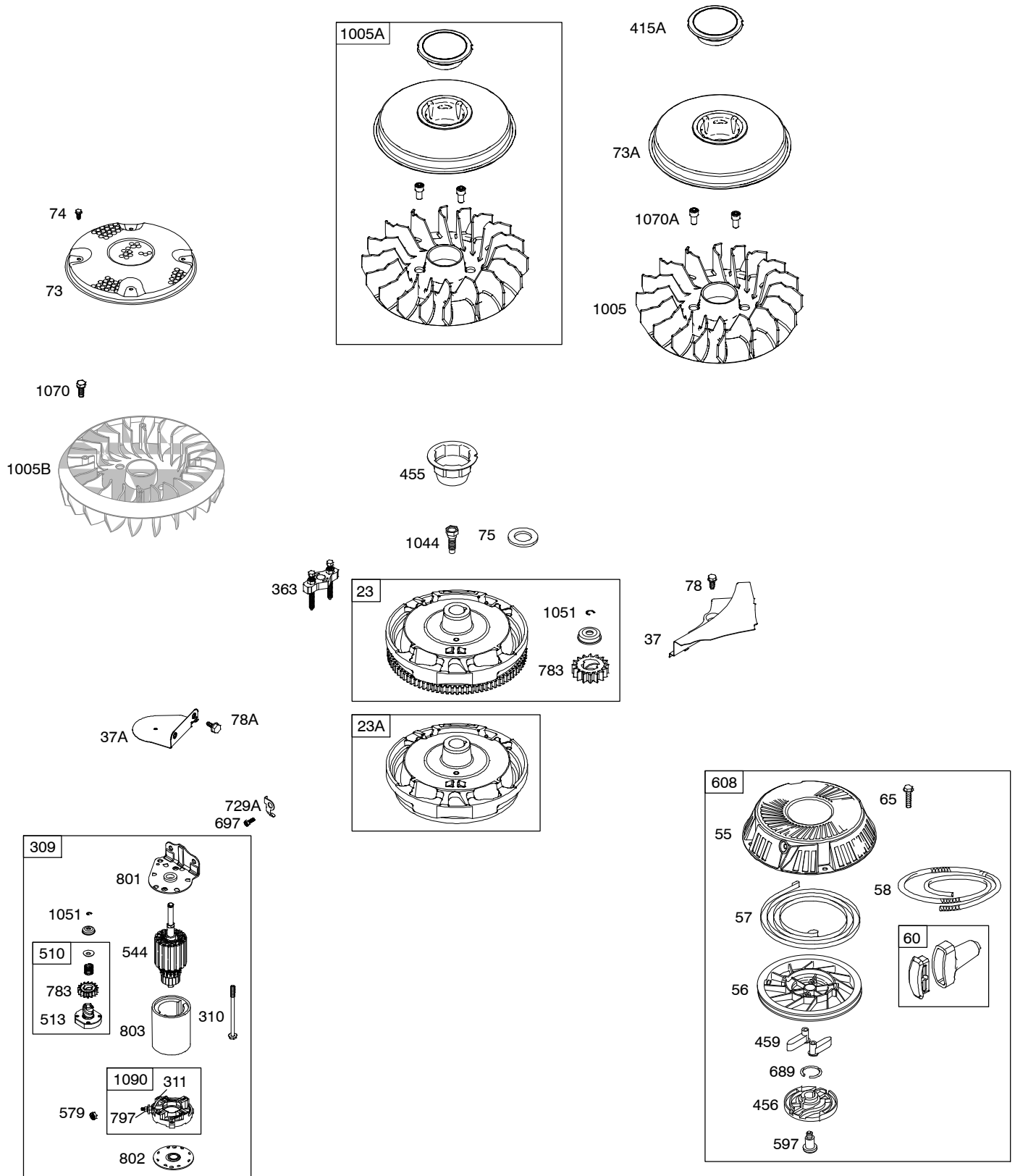

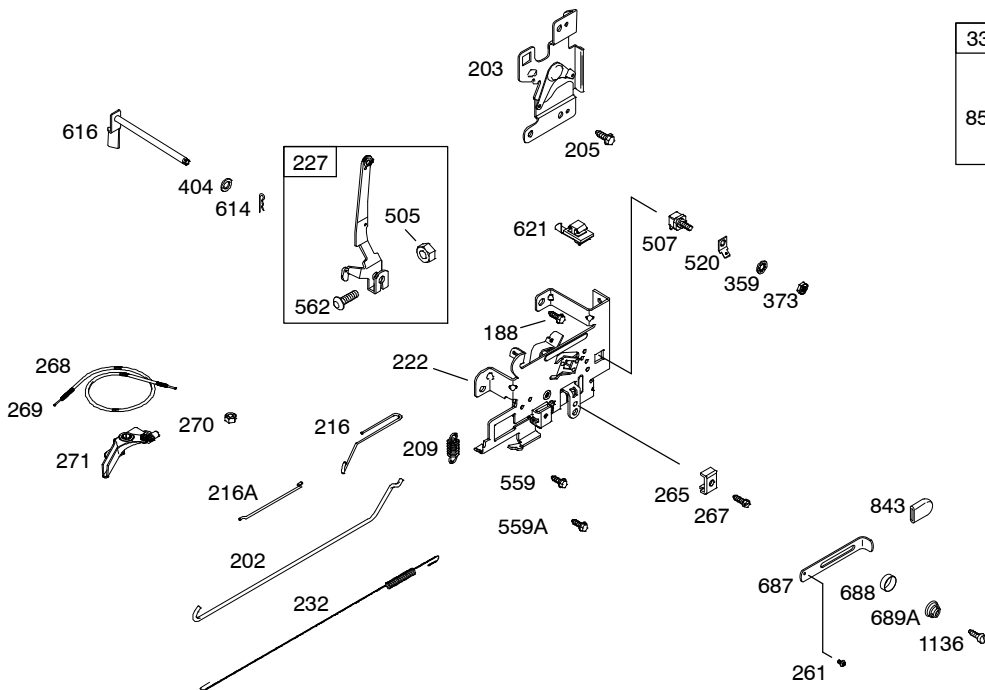
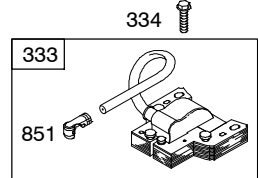
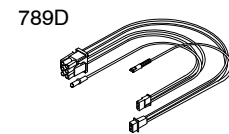
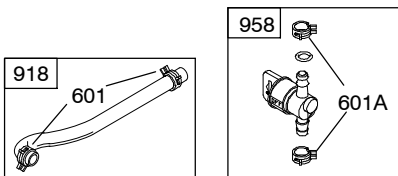
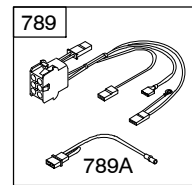
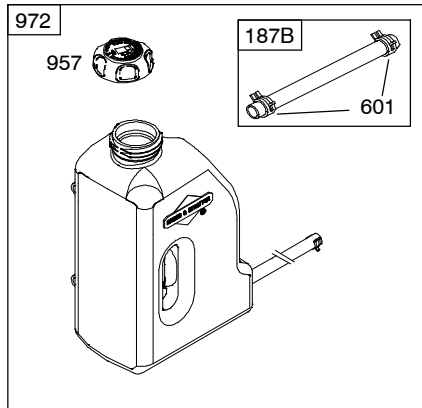
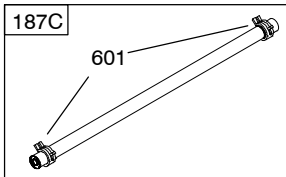
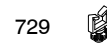
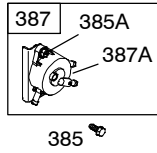
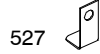
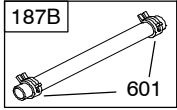
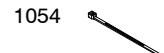
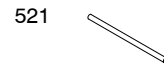
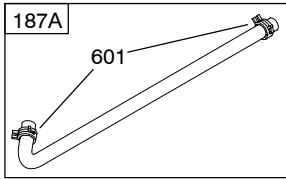
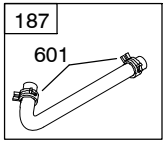

Illustrations cover a range of engines. Parts shown without corresponding text may not be used on your specific engine.
5498-7 Assemblies include all parts shown in frames. 06/09/2008



Illustrations cover a range of engines. Parts shown without corresponding text may not be used on your specific engine.

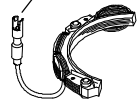

Illustrations cover a range of engines. Parts shown without corresponding text may not be used on your specific engine.

DC ONLY		DUAL CIRCUIT	
474A	1059	474B	1059
877A		877	
			
			

NOTE: All stators use a No. 1119 mounting screw. 

NOTE: The proper flywheel part number and/or the alternator magnet size will determine the alternator type or output. See repair instruction manual for additional information.

REF. NO.	PART NO.	DESCRIPTION	REF. NO.	PART NO.	DESCRIPTION	REF. NO.	PART NO.	DESCRIPTION
1	697377	Cylinder Assembly	14	790560	Stud (Cylinder Head) Used on Type No(s). 0114, 0115, 0117, 0118, 0119, 0121, 0145.	24	222698S	Key-Flywheel
2	399265	Kit-Bushing/Seal (Magneto Side)				25	698767	Piston Assembly (Standard) Used on Type No(s). 0111, 0117, 0127, 0142, 0143, 0381, 0382, 0426, 0542.
3	★391086S	Seal-Oil (Magneto Side)						----- Note -----
4	697106	Sump-Engine (Used After Code Date 05100200). ----- Note ----- 795940 Sump-Engine (Used Before Code Date 05100200). Must Use Kit 795940, Includes Sump And Counterweight.	15	690946	Plug-Oil Drain (Square Head)			698769 Piston Assembly (.020" Oversize) Used on Type No(s). 0111, 0117, 0127, 0142, 0143, 0381, 0382, 0426, 0542.
4A	697188	Sump-Engine (Used After Code Date 05100200). Used on Type No(s). 0111. ----- Note ----- 795957 Sump-Engine (Used Before Code Date 05100200). Used on Type No(s). 0111. Must Use Kit 795957, Includes Sump And Counterweight.	16	698382	Crankshaft Used on Type No(s). 0111, 0117, 0142, 0143, 0145, 0381, 0382, 0426, 0542. ----- Note ----- 697390 Crankshaft Used on Type No(s). 0113, 0114, 0115, 0118, 0119, 0121, 0125, 0129, 0138, 0144, 0393, 0439, 0665. 792907 Crankshaft Used on Type No(s). 0127.			792305 Piston Assembly (Standard) Used on Type No(s). 0113, 0114, 0115, 0118, 0119, 0121, 0125, 0129, 0138, 0144, 0145, 0393, 0439, 0665.
5	792964	Head-Cylinder	20	★791892	Seal-Oil (PTO Side)			792728 Piston Assembly (.020" Oversize) Used on Type No(s). 0113, 0114, 0115, 0118, 0119, 0121, 0125, 0129, 0138, 0144, 0145, 0393, 0439, 0665.
7	★△273280S	Gasket-Cylinder Head	22	692125	Screw (Crankcase Cover/Sump)			
9	★697109	Gasket-Breather (Used Before Code Date 07071900). (After Date Code Use Liquid Sealant Reference 850)	23	693557	Flywheel Used on Type No(s). 0119, 0125, 0127, 0129. ----- Note ----- 698281 Flywheel Used on Type No(s). 0111, 0118, 0142, 0144, 0381, 0382, 0393, 0426, 0439, 0542, 0665.			
10	697157	Screw (Breather Assembly)	23A	693555	Flywheel Used on Type No(s). 0113, 0114, 0115, 0117, 0121, 0138, 0143, .0145.			
11	794683	Tube-Breather (Used After Code Date 07071800). ----- Note ----- 697113 Tube-Breather (Used Before Code Date 07071900).						
12	★697110	Gasket-Crankcase (.015" Thick) (Standard)						
13	690360	Screw (Cylinder Head)						

★ Included in Engine Gasket Set-Ref. No. 358.

● Included in Carburetor Overhaul Kit-Ref. No. 121 or 121A.

◆ Included in Carburetor Gasket Set-Ref. No. 977 or 977A.

△ Included in Valve Gasket Set-Ref. No. 1095.

Illustrations cover a range of engines. Parts shown without corresponding text may not be used on your specific engine.

217800

REF. NO.	PART NO.	DESCRIPTION	REF. NO.	PART NO.	DESCRIPTION	REF. NO.	PART NO.	DESCRIPTION
26	698375	Ring Set (Standard) Used on Type No(s). 0111, 0117, 0127, 0142, 0143, 0381, 0382, 0426, 0542. ----- Note ----- 697120 Ring Set (.020" Oversize) Used on Type No(s). 0111, 0117, 0127, 0142, 0143, 0381, 0382, 0426, 0542. 792306 Ring Set (Standard) Used on Type No(s). 0113, 0114, 0115, 0118, 0119, 0121, 0125, 0129, 0138, 0144, 0145, 0393, 0439, 0665. 792643 Ring Set (.020" Oversize) Used on Type No(s). 0113, 0114, 0115, 0118, 0119, 0121, 0125, 0129, 0138, 0144, 0145, 0393, 0439, 0665.	34	791935	Valve-Intake (Used After Code Date 06120300). ----- Note ----- 695761 Valve-Intake (Used Before Code Date 06120400).	73	697133	Screen-Rotating (Used Before Code Date 07040900).
			35	691279	Spring-Valve (Intake)	73A	7794437	Screen-Rotating (Used After Code Date 07040800).
			36	691279	Spring-Valve (Exhaust)	74	697897	Screw (Rotating Screen) (Used Before Code Date 07040900).
			37	697352	Guard-Flywheel	75	690582	Washer (Flywheel)
			37A	697626	Guard-Flywheel Used on Type No(s). 0113, 0114, 0115, 0117, 0121, 0138, 0143, 0145.	78	691003	Screw (Flywheel Guard)
			42	499586	Keeper-Valve	78A	690364	Screw (Flywheel Guard)
			43	691968	Slinger-Governor/Oil	81	691178	Lock-Muffler Screw
			45	690564	Tappet-Valve	93	690602	Bushing-Throttle Shaft
			46	793880	Camshaft	94	498030	Kit-Idle Mixture (Walbro)
			50	697361	Manifold-Intake	94A	695425	Kit-Idle Mixture (Nikki)
			50B	795756	Manifold-Intake Used on Type No(s). 0129G1.	95	691636	Screw (Throttle Valve) (Walbro)
			51★◆△	692137	Gasket-Intake	95A	690718	Screw (Throttle Valve)
			51A★◆△	794312	Gasket-Intake	98	495800	Kit-Idle Speed (Walbro)
27	698469	Lock-Piston Pin (Used After Code Date 02100300). ----- Note ----- 698138 Lock-Piston Pin (Used Before Code Date 02100400).	53	690227	Stud (Carburetor)	98A	695408	Kit-Idle Speed (Nikki)
28	697099	Pin-Piston	54	691148	Screw (Intake Manifold)	104	690525	Pin-Float Hinge (Walbro)
29	791633	Rod-Connecting (Standard)	55	695130	Housing-Rewind Starter	104A	694918	Pin-Float Hinge (Nikki)
32	791118	Screw (Connecting Rod)	56	695129	Pulley-Starter	105	231855S	Valve-Float Needle (Walbro)
33	791934	Valve-Exhaust (Used After Code Date 06120300). ----- Note ----- 695760 Valve-Exhaust (Used Before Code Date 06120400).	57	695131	Spring-Rewind Starter	105A	696136	Valve-Float Needle (Nikki)
			58	695132	Rope-Starter	106	690577	Seat-Inlet (Walbro)(Gravity Feed) ----- Note ----- 691780 Seat-Inlet (Walbro)(Pump Feed)
			60	493926	Grip-Starter Rope	108	691227	Valve-Choke (Walbro)
			65	690759	Screw (Rewind Starter) (Used After Code Date 07040800). ----- Note ----- 697725 (Rewind Starter) (Used Before Code Date 07040900).	108A	698773	Valve-Choke (Nikki)

★ Included in Engine Gasket Set-Ref. No. 358.

● Included in Carburetor Overhaul Kit-Ref. No. 121 or 121A.

◆ Included in Carburetor Gasket Set-Ref. No. 977 or 977A.

△ Included in Valve Gasket Set-Ref. No. 1095.

Illustrations cover a range of engines. Parts shown without corresponding text may not be used on your specific engine.

REF. NO.	PART NO.	DESCRIPTION	REF. NO.	PART NO.	DESCRIPTION	REF. NO.	PART NO.	DESCRIPTION
117	794258	Jet–Main (Standard)(Carburetor 793362) ----- Note ----- 699897 Jet–Main (Standard)(Carburetor 698944 and 698945)	127	●694524	Plug–Welch (Walbro)	187C	791745	Line–Fuel (23 Inches Long)(Cut To Required Length)
118	791405	Jet–Main (High Altitude) (Carburetor 793362) ----- Note ----- 699898 Jet–Main (High Altitude) (Carburetor 698944 and 698945)	127A	●690727	Plug–Welch (Nikki)	188	691693	Screw (Control Bracket)
118		Jet–Main (High Altitude) (Carburetor 698944 and 698945)	130	790024	Valve–Throttle (Walbro)	192	691986	Adjuster–Rocker Arm
121	790031	Kit–Carburetor Overhaul (Walbro)	130A	698774	Valve–Throttle (Nikki)	202	691841	Link–Mechanical Governor
121A	698787	Kit–Carburetor Overhaul (Nikki)	131	790901	Kit–Throttle Shaft (Walbro)	203	691381	Crank–Bell Used on Type No(s). 0119.
125	793227	Carburetor (Walbro)(Gravity Feed)(Manual Choke) Used on Type No(s). 0127. ----- Note ----- 793227 Carburetor (Used Before Code Date 07122600). Used on Type No(s). 0114.	131A	698776	Kit–Throttle Shaft (Nikki)	205	691693	Screw (Bell Crank)
125A	794653	Carburetor (Nikki)(Gravity Feed) ----- Note ----- 794653 Carburetor (Nikki)(Gravity Feed) (Used After Code Date 07122507). Used on Type No(s). 0111, 0114, 0115, 0117, 0118, 0119, 0121, 0143. 791266 Carburetor (Nikki)(Pump Feed) (Used Before Code Date 07122600). Used on Type No(s). 0111, 0115, 0117, 0118, 0119, 0121, 0143.	133	494381	Float–Carburetor (Walbro)	209	792813	Spring–Governor (Brown) Used on Type No(s). 0111, 0113, 0114, 0118, 0125, 0129. 0145. ----- Note ----- 792602 Spring– Governor (Red) Used on Type No(s). 0115, 0119, 0121, 0127, 0382, 0393, 0439, 0542. 692208 Spring– Governor (Green) Used on Type No(s). 0144, 0665. 691278 Spring– Governor (Platinum) Used on Type No(s). 0117. 690576 Spring– Governor (Gold) Used on Type No(s). 0142. 260902 Spring– Governor Used on Type No(s). 0138, 0381, 0426.
			133A	694914	Float–Carburetor (Nikki)	216	691840	Link–Choke
			135A	698780	Tube–Fuel Transfer (Nikki)(Gravity Feed) ----- Note ----- 792022 Tube–Fuel Transfer (Nikki)(Pump Feed)	216A	691281	Link–Choke Used on Type No(s). 0119.
			137●♦281165S		Gasket–Float Bowl (Walbro)	222	694042	Bracket–Control ----- Note ----- 694335 Bracket– Control Used on Type No(s). 0127.
			137A	♦♦698781	Gasket–Float Bowl (Nikki)			
			141	790902	Kit–Choke Shaft (Walbro)			
			141A	698778	Kit–Choke Shaft (Nikki)			
			141B	790903	Kit–Choke Shaft (Walbro) Used on Type No(s). 0114.			
			141C	793386	Choke Rod (Manual Choke) Used on Type No(s). 0145.			
			142	●790025	Nozzle–Carburetor (Standard)			
			143	790028	Nozzle–Carburetor (High Altitude)			
			146	691639	Key–Timing			
			187	791805	Line–Fuel (Formed)(10–1/4 Inches Long)(Cut to Required Length)			
			187A	791806	Line–Fuel (Formed)(21 Inches Long)(Cut To Required Length)			
			187B	791766	Line–Fuel (15 Inches Long)(Cut To Required Length)			

★ Included in Engine Gasket Set–Ref. No. 358.

● Included in Carburetor Overhaul Kit–Ref. No. 121 or 121A.

♦ Included in Carburetor Gasket Set–Ref. No. 977 or 977A.

△ Included in Valve Gasket Set–Ref. No. 1095.

Illustrations cover a range of engines. Parts shown without corresponding text may not be used on your specific engine.

217800

REF. NO.	PART NO.	DESCRIPTION	REF. NO.	PART NO.	DESCRIPTION	REF. NO.	PART NO.	DESCRIPTION
227	691374	Lever-Governor Control ----- Note ----- 694339 Lever-Governor Control Used on Type No(s). 0127.	270	691027	Nut (Control Wire Casing)	307	691003	Screw (Cylinder Shield)
232	691842	Spring-Governor Link	271	691028	Lever-Control	309	693551	Motor-Starter Used on Type No(s). 0111, 0118, 0119, 0125, 0127, 0129, 0142, 0144, 0381, 0393, 0426, 0439, 0542, 0665.
237	690409	Retainer-Muffler Guard Used on Type No(s). 0114, 0117, 0119, 0125, 0129, 0143, 0145.	276	◆692255	Washer-Sealing Used on Type No(s). 0127.	310	690323	Screw (Starter Motor)
238	691843	Cap-Valve	300A	697349	Muffler Used on Type No(s). 0118, 0119, 0138.	311	497608	Brush Set
240	394358S	Filter-Fuel (White, 75 Microns) Used on Type No(s). 0113, 0125, 0129, 0138, 0142, 0144, 0381, 0382, 0426, 0542, 0665. ----- Note ----- 298090S Filter-Fuel (Red, 150 Microns) Used on Type No(s). 0393, 0439.	300G	794660	Muffler Used on Type No(s). 0111, 0114, 0115, 0117, 0121, 0125, 0129, 0143, 0145. ----- Note ----- 792901 Muffler Used on Type No(s). 0127.	333	795315	Armature-Magneto
240A	691035	Filter-Fuel (Clear, 40 Microns) Used on Type No(s). 0111, 0114, 0115, 0117, 0118, 0119, 0121, 0127, 0143, 0145.	304	698473	Housing-Blower (Black) Used on Type No(s). 0113, 0114, 0115, 0117, 0118, 0121, 0138, 0143, 0145. ----- Note ----- 699085 Housing-Blower (Red) Used on Type No(s). 0111, 0119, 0125, 0129, 0142, 0144, 0381, 0382, 0426, 0542, 0665. 792908 Housing-Blower (Black) Used on Type No(s). 0127.	334	691061	Screw (Magneto Armature)
261	697176	Screw (Control Slide)	304A		Housing-Blower (See OEM for Service) Used on Type No(s). 0393, 0439.	337	491055S	Plug-Spark Used on Type No(s). 0113, 0114, 0115, 0117, 0118, 0121, 0127, 0143, 0145. ----- Note ----- 691043 Plug-Spark Used on Type No(s). 0111, 0119, 0125, 0129, 0138, 0142, 0144, 0381, 0382, 0393, 0542. 792015 Plug-Spark Used on Type No(s). 0426, 0439, 0665.
263	691083	Screw (Muffler Guard Retainer)	305	697102	Screw (Blower Housing)	346	690661	Screw (Spark Arrester)
265	691024	Clamp-Casing	305A	697103	Screw (Blower Housing)	356	697397	Wire-Stop ----- Note ----- 792910 Wire-Stop Used on Type No(s). 0127.
267	794904	Screw (Casing Clamp)	306	697359	Shield-Cylinder ----- Note ----- 792911 Shield-Cylinder Used on Type No(s). 0127.	356A	398808	Wire-Stop
268	691025	Casing-Control Wire (Cut To Required Length)				357	691483	Key-Drive Pulley Used on Type No(s). 0138.
269	691026	Wire-Control (Cut To Required Length)				358	697151	Gasket Set-Engine
						359	691077	Washer (Ground Terminal)
						363	19203	Puller-Flywheel
						373	691612	Nut (Ground Terminal)
						383	89838S	Wrench-Spark Plug

★ Included in Engine Gasket Set-Ref. No. 358.

● Included in Carburetor Overhaul Kit-Ref. No. 121 or 121A.

◆ Included in Carburetor Gasket Set-Ref. No. 977 or 977A.

△ Included in Valve Gasket Set-Ref. No. 1095.

Illustrations cover a range of engines. Parts shown without corresponding text may not be used on your specific engine.

REF. NO.	PART NO.	DESCRIPTION	REF. NO.	PART NO.	DESCRIPTION	REF. NO.	PART NO.	DESCRIPTION
385	694476	Screw (Fuel Pump)	505	691251	Nut (Governor Control Lever)	584	794682	Cover-Breather Passage (Use With Liquid Sealant Reference 850).
385A	690297	Screw (Fuel Pump)	510	693699	Drive-Starter	597	691696	Screw (Pawl Friction Plate)
387	697090	Pump-Fuel (Includes Mounting Bracket) Used on Type No(s). 0111, 0114, 0115, 0117, 0118, 0121, 0125, 0129, 0143, 0144, 0145.	513	692024	Clutch-Drive	601	791850	Clamp-Hose (Zinc Plate)(Spring Wire)
387A	808656	Pump-Fuel Used on Type No(s). 0111, 0114, 0115, 0117, 0118, 0119, 0121, 0125, 0127, 0129, 0143, 0144, 0145.	520	691084	Terminal-Ground	601A	691038	Clamp-Hose (Black)(Spring Steel)
404	691691	Washer (Governor Crank)	521	690581	Shield-Cable	608	695058	Starter-Rewind Used on Type No(s). 0113, 0114, 0115, 0117, 0119, 0121, 0125, 0127, 0129, 0138, 0143, 0145.
415	690283	Plug (Sump) Used on Type No(s). 0111.	523	699908	Dipstick	613	691416	Screw (Muffler)
415A	794129	Plug (Cover/Retainer)	524	★691032	Seal-Dipstick Tube	613A	691678	Screw (Muffler)
431	697122	Elbow-Intake	525	697184	Tube-Dipstick Used on Type No(s). 0113, 0125, 0129, 0138, 0142, 0144, 0381, 0382, 0393, 0426, 0439, 0542, 0665. ----- Note ----- 697085 Tube-Dipstick Used on Type No(s). 0111, 0114, 0115, 0117, 0118, 0119, 0121, 0127, 0143, 0145.	613B	690297	Screw (Muffler)
431A	698937	Elbow-Intake Used on Type No(s). 0393, 0439.	527	792167	Clamp-Tube Used on Type No(s). 0114, 0115, 0117, 0118, 0119, 0121, 0143, 0145.	614	691620	Pin-Cotter
445	698413	Filter-Air Cleaner Cartridge (Non Washable)	536	698973	Cleaner-Air Used on Type No(s). 0393, 0439.	616	692012	Crank-Governor
445	695113	Cup-Flywheel Used on Type No(s). 0113, 0114, 0115, 0117, 0119, 0121, 0125, 0127, 0129, 0138, 0143, 0145.	544	692034	Armature-Starter	617	★692138	Seal-O Ring (Intake Manifold)
456	695128	Plate-Pawl Friction	552	697144	Bushing-Governor Crank	621	692310	Switch-Stop Used on Type No(s). 0114, 0117, 0119, 0143, 0145.
459	281505S	Pawl-Ratchet	559	697561	Screw (Remote Choke Stop)	633	690597	Seal-Choke/Throttle Shaft Used on Type No(s). 0114, 0145.
474A	696578	Alternator (DC Only) Used on Type No(s). 0118, 0393, 0439.	559A	693675	Screw (Remote Choke Stop)			
474B	696459	Alternator (Dual Circuit) Used on Type No(s). 0111, 0119, 0125, 0129, 0142, 0144, 0381, 0382, 0426, 0542, 0665.	562	691119	Bolt (Governor Control Lever)			
			578	692306	Wire Assembly			
			579	691029	Nut (Starter Cable)			

★ Included in Engine Gasket Set-Ref. No. 358.

● Included in Carburetor Overhaul Kit-Ref. No. 121 or 121A.

◆ Included in Carburetor Gasket Set-Ref. No. 977 or 977A.

△ Included in Valve Gasket Set-Ref. No. 1095.

Illustrations cover a range of engines. Parts shown without corresponding text may not be used on your specific engine.

217800

REF. NO.	PART NO.	DESCRIPTION	REF. NO.	PART NO.	DESCRIPTION	REF. NO.	PART NO.	DESCRIPTION
634	●690802	Spring/Seal Assembly (Walbro)	741	697128	Gear-Timing	836	690367	Screw (Muffler Guard)
634A	●698779	Spring/Seal Assembly (Nikki)	750	790832	Screw (Oil Pump Cover)	842	★691031	Seal-O Ring (Dipstick Tube)
635	691909	Boot-Spark Plug	757	793242	Link-Counterweight Used on Type No(s). 0111, 0113, 0114, 0115, 0118, 0119, 0121, 0125, 0129, 0138, 0144, 0145, 0393, 0439, 0665.	843	697158	Sleeve-Lever
643	697155	Retainer-Air Filter ----- Note ----- 792909 Retainer-Air Filter Used on Type No(s). 0127.	758	697391	Counterweight (Used After Code Date 05100200). ----- Note ----- 795940 Counterweight (Used Before Code Date 05100300). Must Use Kit 795940, Includes Sump And Counterweight. 795957 Counterweight (Used Before Code Date 05100300). Used on Type No(s). 0111. Must Use Kit 795957, Includes Sump And Counterweight.	847	790442	Dipstick/Tube Assembly Used on Type No(s). 0113, 0125, 0129, 0138, 0142, 0144, 0381, 0382, 0393, 0426, 0439, 0542, 0665. ----- Note ----- 790443 Dipstick/Tube Assembly Used on Type No(s). 0111, 0114, 0115, 0117, 0118, 0119, 0121, 0127, 0143, 0145.
652	793380	Screw (Choke Shaft)	759	697392	Pin-Counterweight	850	100100	Sealant-Liquid (Rocker Cover Gasket and Breather Gasket).
654	690958	Nut (Carburetor)	783	693713	Gear-Pinion	851	692424	Terminal-Spark Plug
676	393761	Deflector-Muffler (Side Out) Used on Type No(s). 0114, 0117, 0119, 0125, 0129, 0143, 0145.	788	699347	Bracket-Fuel Pump Used on Type No(s). 0119, 0127.	864	697346	Adapter-Muffler Used on Type No(s). 0111, 0114, 0115, 0117, 0118, 0119, 0121, 0125, 0127, 0129, 0138, 0143, 0145.
676A	396903	Deflector-Muffler (Direct Out) Used on Type No(s). 0111.	789	698329	Harness-Wiring	868	★△690968	Seal-Valve
676B	397630	Deflector-Muffler (Louvered) Used on Type No(s). 0127.	789A	790544	Harness-Wiring	877	393456	Wire/Connector-Alternator (Dual Circuit)
677	690661	Screw (Muffler Deflector)	789D	693050	Harness-Wiring Used on Type No(s). 0114, 0145.	877A	393814	Wire/Connector-Alternator (DC Only)
687	697175	Slide-Control	797	693167	Nut (Brush Retainer)	878	398661	Harness-Alternator (Dual Circuit)
688	690395	Cap-Friction	801	691283	Cap-Drive	883	★692236	Gasket-Exhaust
689	691855	Spring-Friction	802	691286	Cap-End	914	691108	Screw (Rocker Cover)
689A	690529	Spring-Friction	803		Housing-Starter (Not Serviced Separately, Order Motor 693551)	918	791851	Hose-Vacuum (Molded)
691	★692407	Seal-Governor Shaft	823	698941	Screw (Muffler Adapter)	943	★690589	Seal-O Ring (Oil Pump Cover)
692	691301	Spring-Detent	830	691095	Stud-Rocker Arm	950	691657	Screw-Float Bowl (Bottom Of Bowl)
697	690372	Screw (Drive Cap)	832	692361	Guard-Muffler Used on Type No(s). 0114, 0117, 0119, 0125, 0129, 0143, 0145.			
705	790561	Nut (Fuel Tank)	832A	790293	Guard-Muffler Used on Type No(s). 0127.			
718	690959	Pin-Locating						
729	691335	Clip-Wire (Wire Retainer)						
729A	691224	Clip-Wire (Starter Motor)						

★ Included in Engine Gasket Set-Ref. No. 358.

● Included in Carburetor Overhaul Kit-Ref. No. 121 or 121A.

◆ Included in Carburetor Gasket Set-Ref. No. 977 or 977A.

△ Included in Valve Gasket Set-Ref. No. 1095.

Illustrations cover a range of engines. Parts shown without corresponding text may not be used on your specific engine.

REF. NO.	PART NO.	DESCRIPTION	REF. NO.	PART NO.	DESCRIPTION	REF. NO.	PART NO.	DESCRIPTION
957	792647	Cap-Fuel Tank (Plastic)	1017	690770	Screen-Oil Pump Used on Type No(s). 0111.	1070	690372	Screw (Flywheel Fan) (Used Before Code Date 07040900).
958	698183	Valve-Fuel Shut Off (Plastic) Used on Type No(s). 0111, 0138.	1022★△272475S		Gasket-Rocker Cover (Used Before Code Date 07091000). (After Date Code Use liquid Sealant Reference 850)	1070A	690363	Screw (Flywheel Fan) (Used After Code Date 07040800).
965	499613	Cover-Oil Pump Used on Type No(s). 0111.	1023	791079	Cover-Rocker	1090	691293	Retainer-Brush
967	697292	Filter-Pre Cleaner	1024	499054	Pump-Oil Used on Type No(s). 0111. (Used Before Code Date 07051700).	1091	691333	Cap-Limiter
968	697420	Cover-Air Cleaner (Black) ----- Note ----- 697422 Cover-Air Cleaner (Red)	1024A	794644	Pump-Oil Used on Type No(s). 0111. (Used After Code Date 07051600).	1095	691581	Gasket Set-Valve
972	792168	Tank-Fuel (Plastic) Used on Type No(s). 0114, 0115, 0117, 0118, 0119, 0121, 0143, 0145.	1026	794573	Rod-Push (Exhaust) ----- Note ----- 697394 Rod-Push (Intake)	1119	691183	Screw (Alternator)
975	495933	Bowl-Float (Walbro)	1027	492932S	Filter-Oil Used on Type No(s). 0111.	1127	695407	Screw (Float Bowl)(Nikki)
975A	698783	Bowl-Float	1029	691751	Arm-Rocker	1136	690278	Screw (Control Bracket)(High Speed Control)
977	690192	Gasket Set-Carburetor (Walbro)	1034	690822	Guide-Push Rod	1263	697124	Reed-Breather
977A	790032	Gasket Set-Carburetor (Nikki)	1036		Label-Emissions (Available From A Briggs & Stratton Authorized Dealer)	1264	697104	Screw (Breather Reed)
987	691326	Seal-Throttle Shaft (Walbro)	1040	698368	Plate-Trim Used on Type No(s). 0111, 0118, 0142, 0144, 0381, 0382, 0426, 0542, 0665.	1266	★691917	Seal-O Ring (Intake Elbow)
987A	698777	Seal-Throttle Shaft (Nikki)	1044	698139	Screw (Flywheel)	1266A	★697123	Seal-O Ring (Intake Elbow)
994	392390	Arrestor-Spark Used on Type No(s). 0127.	1051	691265	Ring-Retaining	1267	697419	Latch-Blower Housing (Black)
1005	794439	Fan-Flywheel (Used After Code Date 07040800).	1054	280275	Tie-Cable	1270	793243	Plug-AVS Counterweight
1005A	794440	Fan-Flywheel (Used Before Code Date 07040900).	1058	276344	Manual-Operator's	1319	794467	Label-Warning
1005B		Fan-Flywheel (No Longer Available) (See Reference 1005A For Service Flywheel Fan).	1059	698516	Kit-Screw/Washer			

★ Included in Engine Gasket Set-Ref. No. 358.

● Included in Carburetor Overhaul Kit-Ref. No. 121 or 121A.

◆ Included in Carburetor Gasket Set-Ref. No. 977 or 977A.

△ Included in Valve Gasket Set-Ref. No. 1095.

Illustrations cover a range of engines. Parts shown without corresponding text may not be used on your specific engine.