

X9C-Naga V

User's Manual

FCC Compliance Statement

This device complies with part 15 of the FCC Rules. Operation is subject to the following two conditions:

1. This device may not cause harmful interference, and
2. This device must accept any interference received, including interference that may cause undesired operation.

FCC WARNING

This equipment has been tested and found to comply with the limits for a Class B digital device, pursuant to Part 15 of the FCC Rules. These limits are designed to provide reasonable protection against harmful interference in a residential installation.

This equipment generates uses and can radiate radio frequency energy and, if not installed and used in accordance with the instructions, may cause harmful interferences to radio communications.

However, there is no guarantee that interference will not occur in a particular installation. If this equipment does cause harmful interference to radio or television reception, which can be determined by turning the equipment off and on, the user is encouraged to try to correct the interference by one or more of the following measures:

- Reorient or relocate the receiving antenna.
- Increase the separation between the equipment and the receiver.
- Connect the equipment into an outlet different from that to which the receiver is connected.
- Consult the dealer or an experienced radio/TV technician for help.

Caution:

To comply with the limits for an FCC Class B computing device, always use the shielded signal cord supplied with this unit.

The Federal Communications Commission warns that changes or modifications of the unit not expressly approved by the party responsible for compliance could void the user's authority to operate the equipment.

CE mark for Class B ITE (Following European standard EN55022/1998; EN61000-3-2/1995; EN61000-3-3/1995, EN55024/1998, EN60950/1992+A1+A2+A3+A4+A11)

Radio Frequency Interference Statement

Warning:

This is a Class B product. In a domestic environment, this product may cause radio interference in which case the user may be required to take adequate measures.

Canadian Doc Notice

For Class B Computing Devices

This digital apparatus does not exceed the Class B limits for radio noise emissions from digital apparatus as set out in the Radio Interference Regulation of the Canadian Department of Communications.

“Le présent appareil numérique n'émet pas de bruits radioélectriques dépassant les limites applicables aux appareils numériques de la class B prescrites dans le Règlement sur le brouillage radioélectrique édicté par le ministère des Communications du Canada.”

TABLE OF CONTENTS

TABLE OF CONTENTS	III
Your New LCD Monitor	1
Unpacking	1
Identifying Components	3
Adjusting the Tilting Angle	5
Connecting AC Power and Video Cable	6
Power Management System	6
The LCD Monitor's Control Panel	7
Adjusting the Monitor's Display	8
TFT LCD Monitor Specifications	14
Supported Timing	16
Troubleshooting	17

The LCD Monitor

Your New LCD Monitor

Your LCD Monitor has been designed to be versatile, ergonomic and user-friendly. The LCD Monitor is capable of displaying most standards, from 640x400 VGA to 1280x1024 SXGA. The digital controls located on the front panel allow the user to easily adjust the Monitor's display parameters, and the LCD Monitor's small footprint gives you more room in your workspace for other peripherals. Lightweight and compact, the LCD Monitor is the perfect solution for users on the go. You can use the LCD Monitor for everything from making business presentations to playing computer games. The Monitor also has a VESA wall-mount function for added convenience.

The architecture of the LCD Monitor incorporates an LCD panel that produces a clear display with low radiation emission. And with its low power consumption, the LCD Monitor helps you reduce your power bill.

Unpacking

Before unpacking your LCD Monitor, prepare a suitable workspace for your LCD Monitor and computer. Look for a stable, level and clean surface near a wall outlet. Even though the LCD Monitor uses very little power, you should put it in a location which allows sufficient airflow to ensure that the LCD Monitor and your computer do not overheat. Set up your LCD Monitor so that the panel is not facing a window where sunlight often comes in. The glare caused by sunlight reflecting off of the LCD Monitor's screen will make it difficult to use the Monitor for viewing.

Note: *Using a computer for an extended period of time with a poor workstation set-up and incorrect working habits can cause health problems. The science of ergonomics studies the relationship between health and a suitable working environment. There is a section on ergonomics at the end of this chapter. For more information on ergonomics, contact your nearest computer bookstore, or local library. The Internet also has information on this and other subjects.*

After unpacking your LCD monitor, make sure the following items are included in the box and are in good condition:

- LCD monitor
- Power Cord
- Monitor-To-PC Analog signal cable 15pin
- Monitor-To-PC DVI signal cable
- 1.5M stereo Jack Audio Cable
- User's manual

If you find that any item to be missing or appear to be damaged, contact your dealer immediately. Do not throw away the packing material or shipping carton in case you need to ship or store the LCD monitor in the future.

Identifying Components

A. The LCD Monitor — Front View

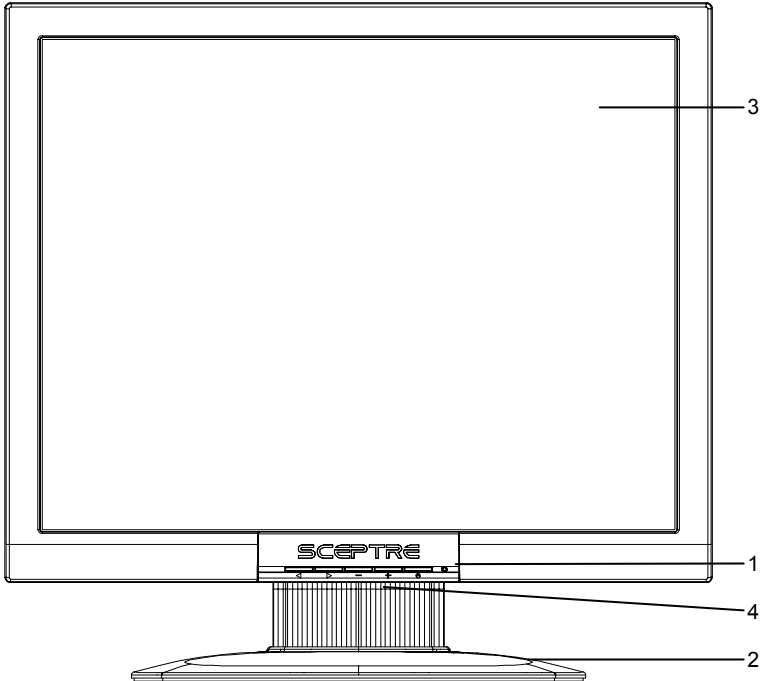

Figure 1-1: The LCD Monitor Front View

- 1. Power-On Indicator**
This Circular LED indicator green lit when the power is on and orange lit when the LCD monitor is in power-saving mode.
- 2. Monitor Stand**
- 3. LCD Screen**
The LCD monitor screen is a 19-inch TFT 1280 x 1024 screen.
- 4. LCD Monitor Control Panel**
Refer to Chapter 2 for more details.

B. "Hot Keys" for Quick Adjustment of Monitor Settings



Figure 1-2: "Hot Keys"

1. Volume Adjustment "hot key":

Press this + button to allow you to adjust the volume of the LCD Monitor directly

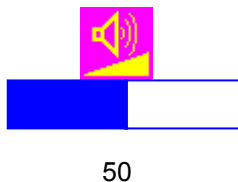

2. Contrast Adjustment " Hot key"

Press this - button to allow you to adjust the contrast of the LCD Monitor directly

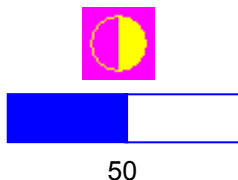

3. Auto adjustment " Hot Key "

Press this  to allow you to do the auto adjustment to get the optimized view

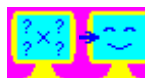

(For VGA port only, DVI port can't adjustment)

Adjusting the Tilting Angle

The LCD Monitor's angle settings range from 0° to 10°.

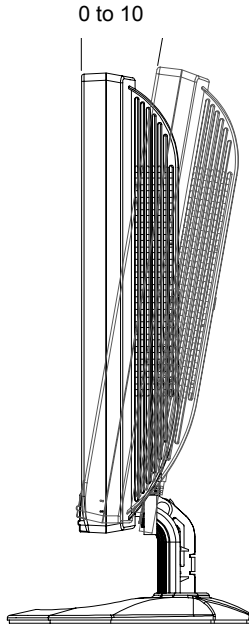

Figure 1-3: Tilting the Monitor

Connecting AC Power and Video Cable

Note: Turn off your PC and the LCD monitor before connecting your LCD monitor to the computer.

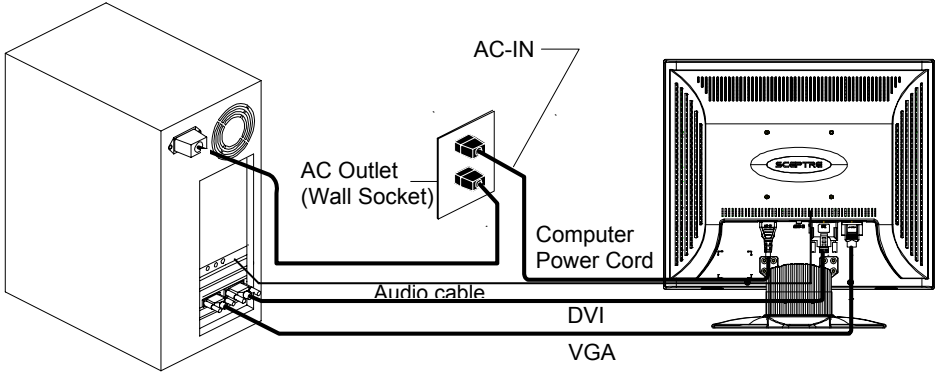

Figure 1-4: The AC Adapter

Power Management System

This LCD Monitor complies with the VESA DPMS power management proposal.

When the LCD Monitor is in power-saving mode or detects an incorrect timing, the monitor screen will be blank and the power LED indicator from green lit change to orange lit.

The Display Controls

The LCD Monitor's Control Panel

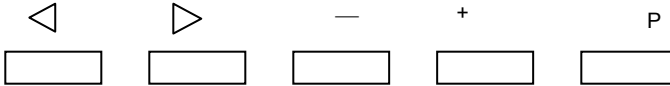

Figure 2-1: The Control Panel

1. ◀ : Enable the OSD Menu button or
/ Move the cursor to the left (when OSD is enabled)
2. ▶ : Move the cursor to the Right (When OSD is enabled)
/ Auto-adjustment hot key
3. - : Enter into the sub-menu or decrease the value
/ Contrast hot key
4. + : Enter into the sub-menu or increase the value
/ Volume hot key
5. ⏻ : Power Switch
This button lets you turn power for the LCD monitor ON or OFF.

Adjusting the Monitor's Display

OSD Main Menu

1. Pressing the ◀ button causes the screen below to appear.
2. Use the ◀ & ▶ key to select the desired group, then press – or + key to enter into sub-menu
3. Repeat step 2 to select the changed item, then – or + to change the value.



The OSD Main Menu

OSD Main SCREEN

Auto Adjust Option



The Auto Adjust option lets the monitor determine and select the settings that are most appropriate for your system requirements.

Note: it only apply for Analog RGB input



Provides you with the current display timing information.



Brightness and Contrast Adjustment



Adjusts the Brightness value



Adjusts the Contrast value



Execute the white balance function



Return to the previous Menu



Audio Function



Volume : Adjust the speaker volume



Mute : Mute the speaker



Return



Color Temperature Adjustment



Set up the color temperature value



User Mode



Sets the color temperature to 6500K



Sets the color temperature to 9300K



Red change Red gain for the color temperature
(only valid when color temperature set at user mode)



Green change Green gain for the color temperature
(only valid when color temperature set at user mode)



Blue change Blue gain for the color temperature
(only valid when color temperature set at user mode)



Return to the previous Menu



Display Quality Adjustment



Auto Adjust: use this option to apply automatically setting



Changes the screen viewing size



Adjusts phase tracking to reduce display flicker



Moves the whole screen right or left



Moves the whole screen up or down



Return to the previous Menu



OSD Adjustment



Restores settings to factory default values



Sets the OSD timer



Moves the OSD menu horizontally



Moves the OSD menu vertically



Set the graphic mode or text mode



Return to the previous Menu



Port Select



Set analog port for PC signal input



Set DVI port for PC signal input



Return to the previous Menu



Exit the OSD screen

Note:

1) No video

When the monitor is ON and there is no video signal received, the following message will be displayed



2) Signal out of range

When the frequency range of the signal is out of the Monitor's specifications, (over 85HZ) the display will show the following message

Out of Range

Appendix A

TFT LCD Monitor Specifications

Item	Specification	
LCD Panel	19" SXGA	
Control Functions Power	Software Power switch with LED indicator (ON/OFF)	
On-Screen Display (OSD)	Main Menu	Submenu
	Information	
	Brightness /Contrast Control	Brightness/Contrast/White balance/Exit
	Audio Control	Volume/Mute/Exit
	Color temperature Control	User mode, 9300K, 6500K R,G,B, gain value
	Display Quality	Auto Adjustment/Phase adjustment/Screen Size/ Screen Horizontal position/Screen Vertical position/Exit
	OSD adjustment	Restore to the default/OSD timer/OSD Horizontal Position/OSD Vertical Position/640&720/Exit
	Source	D-SUB / DVI / Exit
	Exit	
Display Area (mm)	376.32 x 301.056 (19" diagonal)	
Display Colors	16 M	
Video Interface	VGA Compatible Analog RGB Digital DVI interface	

Item	Specificaliton
Scanning Frequency H/V, Hz	24-80K 50-75
Power Management	Meets VESA DPMS
Power Consumption (ON/OFF, W)	37W/1W Max.
Dimensions WxHxD	16.54 x 16.4 x 6.81 in. (420.2 x 416.5 x 173mm)
Net Weight (approx.)	11 lbs (5 Kg)
Power Supply	Universal Input AC Socket
Environment	Operating Temperature: 32 to 104°F (0 to 40° C) Relative Humidity: 10% to 90%
Regulatory	FCC B DoC,UL/cUL,Energy star

Appendix B

Supported Timing

Item	Standards	Resolution	Dot Clock (MHz)	Vertical Scanning Frequency (Hz)	Horizontal Scanning Frequency (kHz)
1	NEC PC98	640x400	21.05	56.42	24.83
2	MAC 13" mode	640x480	30.24	66.67	35.00
3	MAC 16" mode	832x624	57.28	74.55	49.73
4	MAC 17" mode	1024x768	80.00	75.02	60.24
5	VGA	640x350	25.18	70.09	31.47
6	VGA	640x400	25.18	70.09	31.47
7	VGA	640x480	25.18	59.94	31.47
8	VESA	640x480	31.50	72.81	37.86
9	VESA	640x480	31.50	75.00	37.50
10	VESA	800x600	36.00	56.25	35.16
11	SVGA	800x600	40.00	60.32	37.88
12	VESA	800x600	50.00	72.19	48.08
13	VESA	800x600	49.50	75.00	46.88
14	VGA	720x400	28.32	70.09	31.47
15	XGA	1024x768	65.00	60.00	48.36
16	VESA	1024x768	75.00	70.07	56.48
17	VESA	1024x768	78.75	75.03	60.02
18	VESA	1280X1024	108	60	63.98
19	VESA	1280X1024	135	75	80

*Once a mode is optimized, there is no need to make any further adjustment as long as the VGA card remains unchanged.

*Specifications are subject to change without notice.

Appendix C

Troubleshooting

This LCD monitor comes pre-adjusted with standard VGA timing. Due to output timing differences among various VGA cards, you may initially experience an unstable or unclear display when a new display mode or new VGA card is selected.

Before applying any of the following troubleshooting procedures, you should first apply the Auto Adjust option in the OSD menu.

PROBLEM: Display is unclear and unstable

To stabilize and clarify your display, open the OSD and adjust the clock and phase to obtain a clear display

PROBLEM: There is no LCD display

If there is no display on the LCD, refer to the following:

1. Make sure that the power indicator on the LCD monitor is lit, that all connections are secure, and that the system is running on the correct timing. Refer to Appendix B for information on timing.
2. Turn off the LCD monitor and then turn it back on again. Press the OSD Menu button (refer to Chapter 2) once and then press one of the Adjustment Control buttons several times. If there is still no display, press the other Adjustment Control button several times.
3. If step 2 does not work, connect your PC system to another external CRT. If your PC system functions properly with a CRT monitor but it does not function with the LCD monitor, and the LCD monitor's power LED is blinking, the output timing of the PC's VGA card may be out of the LCD's synchronous range. Change to one of the alternate modes listed in Appendix B, or replace the VGA card and repeat steps 1 and 2.

4. If the power LED is not lit, check that the AC power connector is securely connected, and verify that the AC adapter LED is lit. If the AC adapter LED is not lit, please contact your dealer for assistance.

PROBLEM: The LCD displays “signal out of range” error message

1. If you have a CRT monitor, please connect the CRT monitor to the computer and change the refresh rate down to 60 Hz via your video card's display settings menu. After the setting of 60 Hz has been change you can then use the LCD on the computer.
2. If you do NOT have a CRT monitor, please make sure both the X9C-NagaV and your computer is turned off. Afterwards turn on the LCD and the computer.
3. While the computer is turned on, press the “F8” key on your keyboard continuously until a selection menu appears and select the “Safe Mode” option.
4. When you've entered Safe Mode please uninstall any video card driver and monitor driver by using either the “Add / Remove Programs” icon or going into “System Properties” and manually removing anything under “Monitors” and “Display Adapters”.
5. After removing all the drivers, please reboot your computer and you should be able to see windows. Please then proceed to install your monitor driver first, then your video card driver. Please remember to make sure your refresh rate should be at 60 Hz.