

SAMSUNG

COLOUR TELEVISION

SP43L2HX

SP50L2HX

SP61L2HX

SP46L5HX

SP56L5HX

Owner's Instructions

Before operating the unit,
please read this manual thoroughly,
and retain it for future reference.

**ON-SCREEN MENUS
PICTURE IN PICTURE (PIP)
TELETEXT**

 **DOLBY SURROUND**
PRO • LOGIC

 **DNIe™**

Safety Instructions

- ◆ Do not expose the television to extreme temperature conditions or to extreme humidity conditions.
- ◆ Do not expose the television to direct sunlight and other sources of heat.
- ◆ Do not expose the television to any liquids.
- ◆ Never put objects of any kind into the television, and do not place a water-containing vessel on the television.
- ◆ During a storm conditions (especially when there is lightning) unplug the television from the mains socket and aerial.
- ◆ Do not step on or twist the power cord.
- ◆ Do not overload wall outlets or extension cords as this can result in a risk of fire or electric shock.
- ◆ Please use a soft and dry cloth (not containing volatile matter) when you clean the TV.
- ◆ If the television is broken, do not try to repair it yourself. Contact qualified service personnel.
- ◆ If the remote control is not used for a long period of time, remove the batteries and store it in a cool, dry place.
- ◆ Do not drop the remote control.

This device is not for use in industrial environments.

Caution

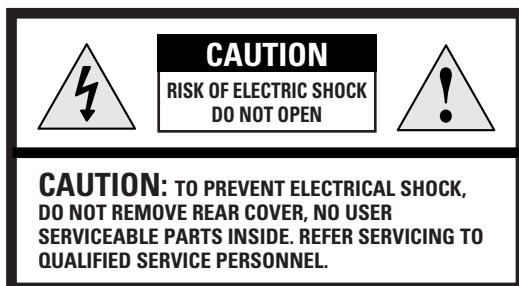

WARNING: TO PREVENT DAMAGE WHICH MAY RESULT IN FIRE OR SHOCK HAZARD. DO NOT EXPOSE THIS APPLIANCE TO RAIN OR MOISTURE.

The lightning flash and arrow head within the triangle is a warning sign alerting you of "dangerous voltage" inside the product.

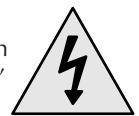

The exclamation point within the triangle is a warning sign alerting you of important instructions accompanying the product.



 **The main voltage is indicated on the rear of the TV set and the frequency is 50 or 60Hz.**

Contents

◆ FOREWORD	
■ Safety Instructions	2
■ Caution	2
■ Replacing the Lamp.....	5~6
◆ CONNECTING AND PREPARING YOUR TELEVISION	
■ Control Panel of Your Television	7~8
■ Connection Panel of Your Television	9
■ Connecting to an Aerial or Cable Television Network	10
■ Connecting a Satellite Receiver or Decoder.....	10
■ Connecting Additional Speakers	11
■ Inserting the Batteries in the Remote Control.....	11
■ Infrared Remote Control	12
■ Switching Your Television On and Off.....	13
■ Placing Your Television in Standby Mode	13
■ Becoming Familiar with the Remote Control	14
■ Plug & Play Feature.....	15~16
■ Choosing Your Language.....	16
◆ SETTING THE CHANNELS	
■ Storing Channels Automatically.....	17
■ Storing Channels Manually.....	18~19
■ Skipping Unwanted Channels	20
■ Sorting the Stored Channels	21
■ Assigning Names to Channels	22
■ Activating the Child Lock	23
■ Selecting a Channel by Information.....	24
◆ USING YOUR TELEVISION (continued)	
■ Changing the Picture Standard	25
■ Adjusting the Picture Settings.....	26
■ Adjusting the Picture Settings (PC or DVI Mode)	27
■ Setting the Picture (PC Mode).....	28
■ Using the Fine Tune	29
■ Viewing the Channel Scan Picture	30
■ Freezing the Current Picture	30
■ Using the LNA (Low Noise Amplifier) Feature.....	31
■ Selecting the Picture Size.....	32
■ Using the Digital NR (Digital Noise Reduction) Feature	33
■ DNie™ (Digital Natural Image engine) DNie™	34
■ Setting the Blue Screen.....	35
■ Selecting the Film Mode	35
■ Changing the Sound Standard	36

Contents (continued)

◆ USING YOUR TELEVISION	
■ Adjusting the Sound Settings	37
■ Adjusting the Volume Automatically	37
■ Setting the Dolby Pro Logic	38
■ Adjusting Your Dolby Preferences.....	39
■ Setting the External Sound.....	40
■ Selecting the Sound Mode (depending on the model)	41
■ Setting the Melody Sound	42
■ Setting the Sleep Timer	43
■ Setting and Displaying the Current Time	44
■ Switching the Television On and Off Automatically	45
■ Viewing an External Signal Source	46
■ Viewing the Picture In Picture (PIP)	47-48
■ Listening to the Sound of the Sub Picture (PC or DVI Mode).....	49
◆ USING THE TELETEXT FEATURE	
■ Teletext Feature	50
■ Displaying the Teletext Information	51
■ Selecting Display Options.....	52
■ Selecting a Teletext Page.....	53
◆ ADDITIONAL INFORMATION AND CONNECTIONS	
■ Connecting to the External Input/Output	54
■ Connecting to the DVD Input.....	55
■ Connecting to the Audio Outputs.....	55
■ Connecting to the Audio/Video Input.....	56
■ Connecting to the S-Video Input.....	56
■ Connecting to the DVI Input	57
■ Connecting to the PC Input	57
■ Setting up Your PC Software (Windows only)	58
■ Input Mode (PC/DVI)	59
■ Pin Configurations	60
■ Programming the Remote Control for Other Components	61
– VCR Remote Control Codes	62-63
– Cable Box (CATV) Remote Control Codes	63
– DVD Remote Control Codes	63
◆ RECOMMENDATIONS FOR USE	
■ Troubleshooting: Before Contacting Service Personnel.....	64
■ Technical Specifications	65

Symbols



Press



Important



Note

Replacing the Lamp (SP43L2HX/SP50L2HX/SP61L2HX)

ENG

- 1 Use a screwdriver to remove the screw.
- 2 Remove the Lamp cover.
- 3 Use a screwdriver to remove the screws securing the Lamp. There are 2 screws: one on the up and one on the down. When the screws have been completely unfastened, they will still be connected to the body of the Lamp.
- 4 Separate the Lamp from the engine by holding the handle and pulling it out.
- 5 To reinstall the Lamp, follow these steps in reverse order.

☛ A Projection TV lamp is a consumable item, and should be replaced from time to time for best projector operation. If the screen image becomes dark, or timer, lamp and Temp LEDs flicker off at the same time, you may have to replace the lamp. When changing the lamp, you should first verify the type/model, and then use only the correct lamp replacement. The code for lamp regulation and usage is marked on the label. If you remove the lamp, you can identify this replacement code. You should only replace the lamp with the one of the same regulation code.

- ◆ If you wish to buy a new lamp, please phone your Service Center or a nearby TV dealer, and tell them the model of your projection unit.
- ◆ You can identify the lamp type on the left side of TV and the lamp cover.
- ◆ The TV will be damaged if you use a lamp that is different from the original supplied by the manufacturer. Be sure the replacement lamp is the same model.
- ◆ Please don't remove the lamp except when replacing with a new one.
- ◆ Please turn off TV power before changing a lamp and then unplug after waiting 1 minute.
- ◆ The cooling fan will help cool the lamp so you can safely remove it. The surface of the Lamp is very hot. Please wait for 30 minutes after turning off your projection TV to handle the lamp.
- ◆ Please keep the old lamp away from flammable articles and children. Dispose of properly.
- ◆ Don't allow dirt or dust to accumulate inside the lamp cover or on the Lamp.
- ◆ A dirty cover or lamp can catch fire, explode and cause electric shock.
- ◆ Please don't touch the front glass of a new lamp or the glass of the lamp container.
- ◆ If a new lamp is improperly handled, the quality of the screen image can be affected and the expected life span of the lamp can be reduced.
- ◆ Be sure to tighten the lamp cover on the TV after changing the lamp. Note that the TV will not function if the lamp cover is not securely attached. Please tighten the holding screw on the lamp cover after it has been attached to the TV.

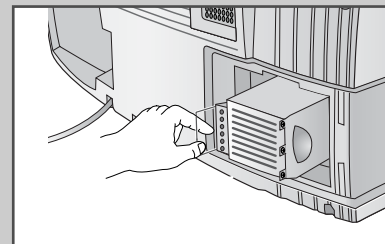
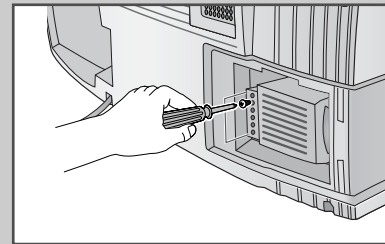
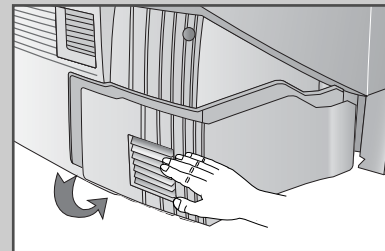
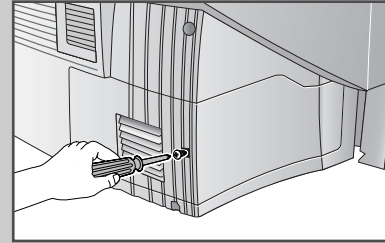

Replacing the Lamp (SP46L5HX/SP56L5HX)

ENG

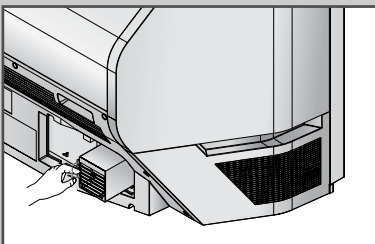
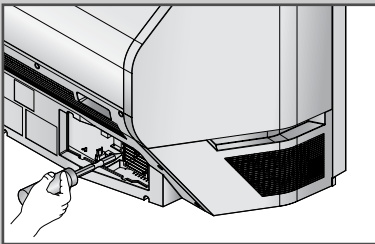
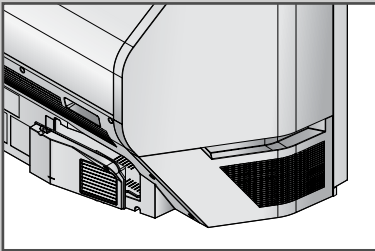
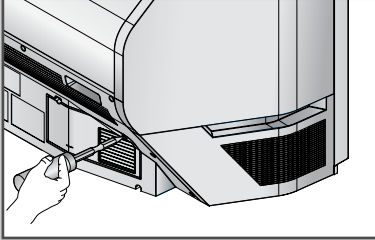

- 1 Use a screwdriver to remove the screw.
- 2 Remove the Lamp cover.
- 3 Use a screwdriver to remove the screws securing the Lamp. There are 2 screws: one on the up and one on the down. When the screws have been completely unfastened, they will still be connected to the body of the Lamp.
- 4 Separate the Lamp from the engine by holding the handle and pulling it out.
- 5 To reinstall the Lamp, follow these steps in reverse order.

☛ A Projection TV lamp is a consumable item, and should be replaced from time to time for best projector operation. If the screen image becomes dark, or timer, lamp and Temp LEDs flicker off at the same time, you may have to replace the lamp. When changing the lamp, you should first verify the type/model, and then use only the correct lamp replacement. The code for lamp regulation and usage is marked on the label. If you remove the lamp, you can identify this replacement code. You should only replace the lamp with the one of the same regulation code.

- ◆ If you wish to buy a new lamp, please phone your Service Center or a nearby TV dealer, and tell them the model of your projection unit.
- ◆ You can identify the lamp type on the left side of TV and the lamp cover.
- ◆ The TV will be damaged if you use a lamp that is different from the original supplied by the manufacturer. Be sure the replacement lamp is the same model.
- ◆ Please don't remove the lamp except when replacing with a new one.
- ◆ Please turn off TV power before changing a lamp and then unplug after waiting 1 minute.
- ◆ The cooling fan will help cool the lamp so you can safely remove it. The surface of the Lamp is very hot. Please wait for 30 minutes after turning off your projection TV to handle the lamp.
- ◆ Please keep the old lamp away from flammable articles and children. Dispose of properly.
- ◆ Don't allow dirt or dust to accumulate inside the lamp cover or on the Lamp.
- ◆ A dirty cover or lamp can catch fire, explode and cause electric shock.
- ◆ Please don't touch the front glass of a new lamp or the glass of the lamp container.
- ◆ If a new lamp is improperly handled, the quality of the screen image can be affected and the expected life span of the lamp can be reduced.
- ◆ Be sure to tighten the lamp cover on the TV after changing the lamp. Note that the TV will not function if the lamp cover is not securely attached. Please tighten the holding screw on the lamp cover after it has been attached to the TV.

Control Panel of Your Television

➤ The actual configuration on your TV may be different, depending on your model.

ENG

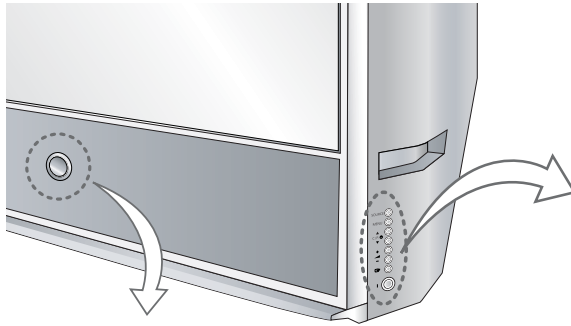

LED Indicators

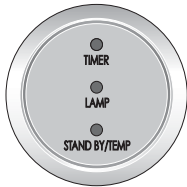

SP46L5/56L5HX

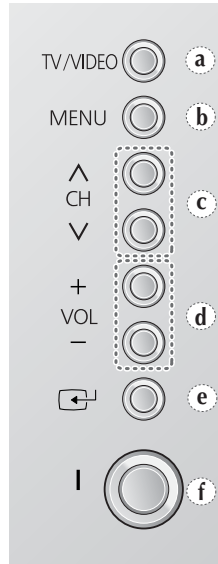

SP43L2/50L2HX

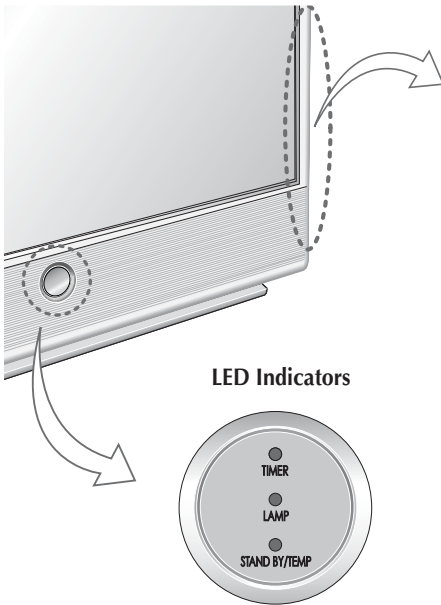

LED Indicators

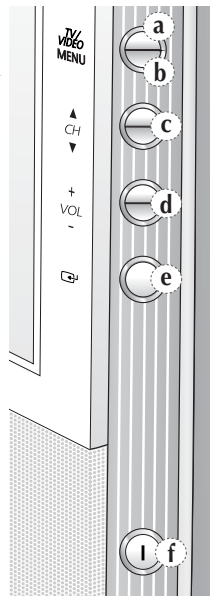
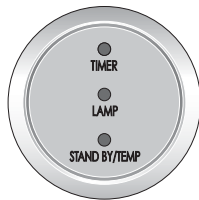

SP61L2HX



- (a) Input Source Selection
- (b) Menu Display
- (c) Channel Selection

- (d) Volume Adjustment
- (e) Confirm your choice (Store or Enter)
- (f) Power On/Off

Control Panel of Your Television (continued)

ENG

(●:On, ◐:Blinking, ○:Off)

TIMER	LAMP	STAND BY/TEMP	Indication
○	○	●	Standby mode.
●	○	○	A timer pilot lights when Timer Auto On or Off is selected.
○	●	○	Normal operation.
●	●	○	Normal operation (when Timer Auto On or Off is selected).
○	◐	○	Lamp is warming up. The normal picture comes on after 25 seconds.
●	◐	○	The normal picture comes on after 25 seconds. (when Timer Auto On or Off is selected)
○	◐	◐	Air vent cover in the rear of the TV is not properly installed.
○	○	◐	Inside temperature of the TV is over normal. Clean the air vent cover in the rear of the TV. Turn the TV back on after 1 hour.
◐	◐	◐	The lamp does not work, please contact an authorized Service Center for assistance.

➤ Using the Buttons on the Panel

If the remote control no longer works or you have lost it, you can use controls on the panel of the TV to:

- ◆ Switch on the TV when it is in Standby mode and select channels (▲ CH ▼ or ^ CH v).
- ◆ Access the menu (MENU).
- ◆ Adjust the volume (- VOL+).
- ◆ Switch among Video input modes (TV/VIDEO).

Connection Panel of Your Television

➤ The actual configuration on your TV may be different, depending on your model.

ENG

Side of the TV

SP43L2HX/50L2HX/61L2HX

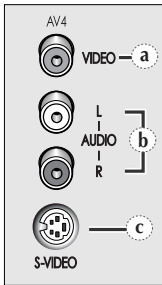

SP46L5HX/56L5HX



- (a) Video Input
- (b) Audio Inputs
- (c) S-Video Input

Rear of the TV

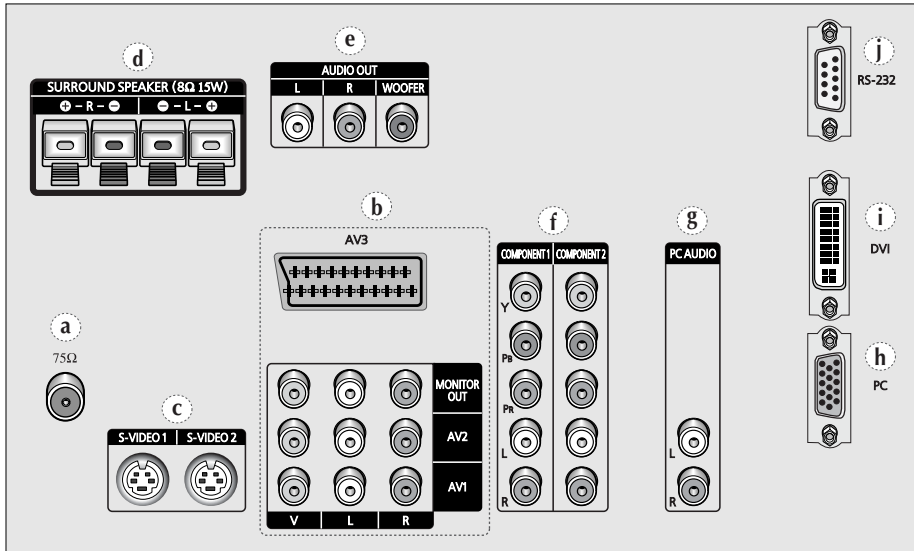

- a) **75Ω**
Coaxial connector for Aerial or Cable Network.
- b) **MONITOR OUT / AV1 / AV2 / AV3**
Inputs or outputs for external devices, such as VCR, DVD, video game device or video disc players.
- c) **S-VIDEO 1 / S-VIDEO 2**
Video input for external devices with an S-Video output, such as a camcorder or VCR.
- d) **SURROUND SPEAKER (8Ω 15W)**
Connectors for external rear speakers.
- e) **AUDIO OUT**
Amplifier (L/R) or powered speaker (**WOOFER**) connection to take full advantage of the surround sound effect.
- f) **COMPONENT 1 / COMPONENT 2**
Video (Y/PB/PR) and audio (L/R) inputs for Component. (480i/480p, 576i/576p, 720p, 1080i)
- g) **PC AUDIO (L/R)**
PC or DVI Audio inputs.
- h) **PC (15 Pin)**
PC Video input.
- i) **DVI (24 Pin)**
Video input for device with DVI input.
- j) **RS-232** (only for service)

➤ For further details about connection, refer to pages 54~60.

Connecting to an Aerial or Cable Television Network

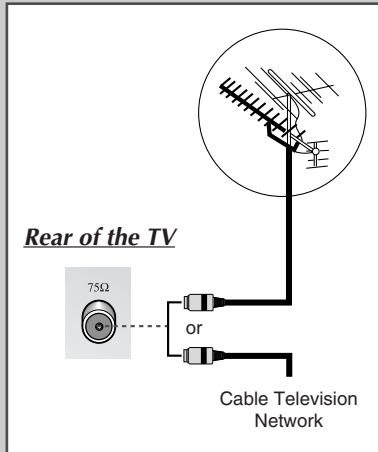

To view television channels correctly, a signal must be received by the set from one of the following sources:

- ◆ An outdoor aerial
- ◆ A cable television network
- ◆ A satellite network

- 1 In the first three cases, connect the aerial or network input cable to the 75Ω coaxial socket on the rear of the television.
- 2 If you are using an indoor aerial, you may need to turn it when tuning your television until you obtain a picture that is both sharp and clear.
For further details, refer to:
 - ◆ "Storing Channels Automatically" on page 17.
 - ◆ "Storing Channels Manually" on page 18.

Connecting a Satellite Receiver or Decoder

In order to watch television programmes broadcast via a satellite network, you must connect a satellite receiver to the rear of TV. Also, in order to descramble a coded transmission signal, you must connect a decoder to the rear of TV.

- ◆ **Using a SCART cable**
Connect the receiver (or decoder) SCART cable to one of the SCART connectors on the rear of the television.
- ◆ **Using a coaxial cable**
Connect a coaxial cable to the:
 - Receiver (or Decoder) output socket.
 - Television aerial input socket.
- If you wish to connect both a satellite receiver (or decoder) and a VCR, you should connect the:
 - ◆ Receiver (or Decoder) to the VCR
 - ◆ VCR to the television
 Otherwise, connect the receiver (or decoder) directly to the television.

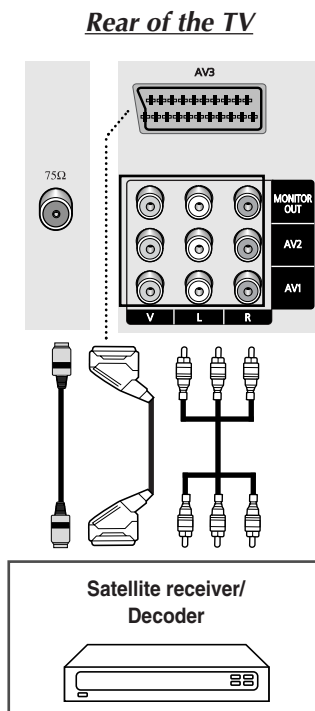

Connecting Additional Speakers

To take advantage of the surround sound system, connect additional speakers.

The speaker terminals are located on the rear of the television:

- ◆ Two for the left-hand surround speaker (marked **L**)
- ◆ Two for the right-hand surround speaker (marked **R**)

- To improve the quality of the sound, connect the:
 - ◆ Red wire to the red terminal
 - ◆ Black wire to the black terminal

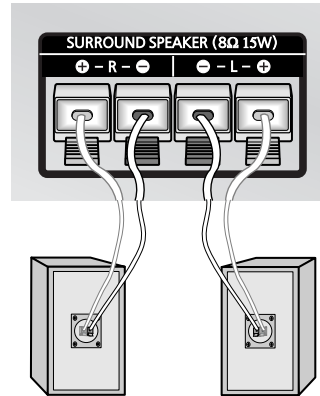

Inserting the Batteries in the Remote Control

You must insert or replace the batteries in the remote control when you:

- ◆ Purchase the television
- ◆ Find that the remote control is no longer operating correctly

- 1 Remove the cover on the rear of the remote control by pressing the symbol (▼) downwards and then pulling firmly to remove it.
- 2 Insert two R03, UM4, "AAA" 1.5V or equivalent batteries taking care to respect the polarities:
 - ◆ - on the battery against - on the remote control
 - ◆ + on the battery against + on the remote control
- 3 Replace the cover by aligning it with the base of the remote control and pressing it back into place.

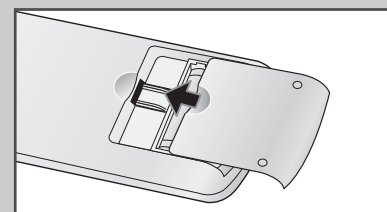
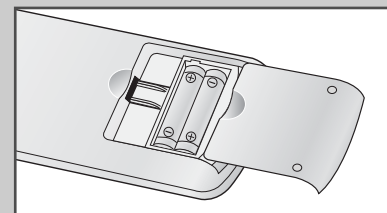
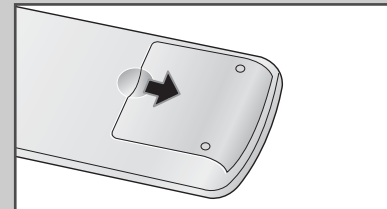

Infrared Remote Control

ENG

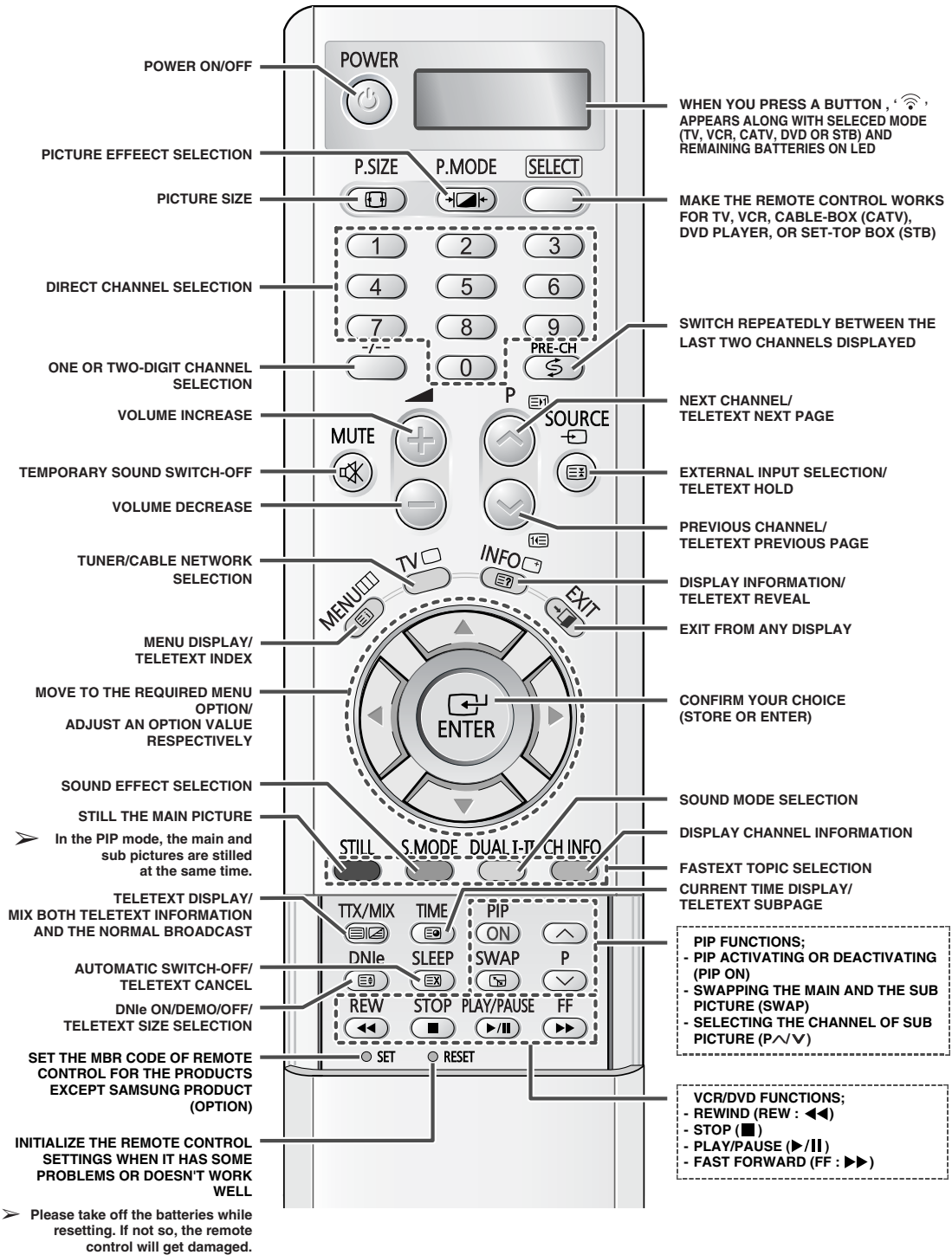

➤ The performance of the remote control may be affected by bright light.

Switching Your Television On and Off

ENG

The mains lead is attached to the rear of your television.

- 1 Plug the mains lead into an appropriate socket.
 - The main voltage is indicated on the rear of the television and the frequency is 50 or 60Hz.
- 2 Press the "I" button (On/Off) on the side of the television.
Result: The Standby indicator on the side of the television lights up.
- 3 Press the **POWER** (⏻) button on the remote control to switch the television on.
Result: The programme that you were watching last is re-selected automatically.
 - If you have not yet stored any channels, No clear picture appears. Refer to "Storing Channels Automatically" on page 17 or "Storing Channels Manually" on page 18.
- 4 To switch your television off, press the "I" button (On/Off) again.

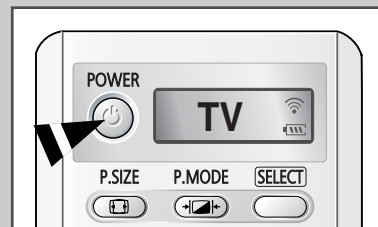

Placing Your Television in Standby Mode

Your television can be placed in Standby mode, in order to reduce the Power consumption.

The Standby mode can be useful when you wish to interrupt viewing temporarily (during a meal, for example).

- 1 Press the **POWER** (⏻) button on the remote control.
Result: The screen is turned off and the Standby indicator on the front of the television lights.
- 2 To switch the television back on, simply press the **POWER** (⏻) button again or a numeric button.
 - You can also switch on by pressing the **P** (⏻) or (⏻) button.

👉 Do not leave your television in Standby mode for long periods of time (when you are away on holiday, for example). Turn your television off by pressing the "I" button (On/Off) on the side of the television. It is best to unplug the set from the mains and aerial.

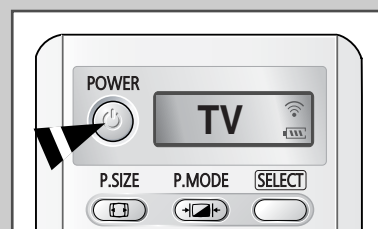

Becoming Familiar with the Remote Control

ENG

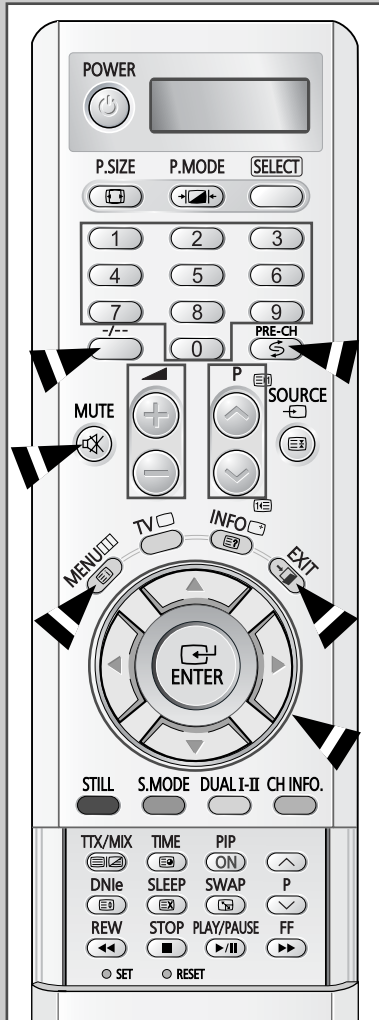

The remote control is used mainly to:

- ◆ Change channels and adjust the volume
- ◆ Display the on-screen menu system

The following table presents the most frequently used buttons and their functions.

Button	Viewing Function	Menu Function
	Used to display the next stored channel.	-
	Used to display the previous stored channel.	-
	Used to display the corresponding channels. ➤ For double digit channels, the second digit must be pushed immediately after the first. Failure to do this will result in a single digit channel being displayed.	
	Used to select a channel numbered ten or over. Press this button, and the "--" symbol is displayed. Enter the two-digit channel number.	
PRE-CH ()	Used to switch repeatedly between the last two channels displayed.	
	Used to increase the volume.	-
	Used to decrease the volume.	-
MUTE ()	Used to switch the sound off temporarily. ➤ To turn the sound back on, press this button again, or press the or button.	
MENU ()	Used to display the on-screen menu system.	Used to return to the previous menu or normal viewing.
	-	Used to: ◆ Display a submenu containing selections for the current menu option ◆ Increase/decrease a menu option value
	-	Used to confirm your choice.
EXIT ()	-	Used to exit from the menu system and return to normal viewing directly.

Plug & Play Feature

ENG

When the television is initially powered ON, several basic customer settings proceed automatically and subsequently. The following settings are available.

- 1 If the television is in Standby mode, press the **POWER** (⏻) button on the remote control.
Result: The message **Plug & Play** is displayed. It flickers for a little while, and then the **Language** menu is automatically displayed.
- 2 Select the appropriate language by pressing the ▼ or ▲ button.
- 3 Press the **ENTER** (↵) button to confirm your choice.
Result: The message **Antenna Input Check** is displayed.
- 4 Make sure that the antenna is connected to the TV, and then press the **ENTER** (↵) button.
Result: The **Area** menu is displayed.
- 5 Select your area by pressing the ▼ or ▲ button.
- 6 Press the **ENTER** (↵) button to confirm your choice.
Result: The **Auto Store** menu is displayed.
- 7 To start the search, select the **Start** and press the **ENTER** (↵) button.
Result: The search will end automatically. Channels are sorted and stored in an order which reflects their position in the frequency range, (with lowest first and highest last). The programme originally selected is then displayed.
➤ To stop the search before it has finished or return to normal viewing, press the **EXIT** (⏻) or **ENTER** (↵) button.
- 8 When it has finished, the message **Enjoy your watching** is displayed, and then the channel which has been stored will be activated.

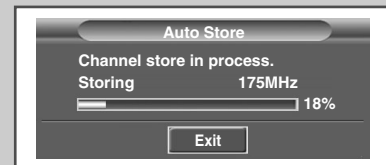
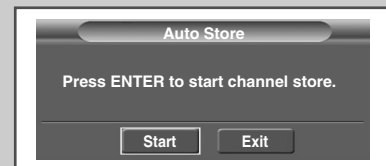
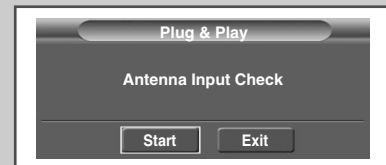

Enjoy your watching

Plug & Play Feature (continued)

ENG

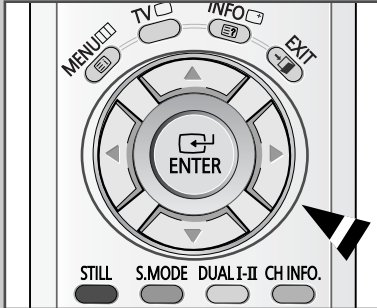

If you want to reset this feature...

- 1 Press the **MENU** () button.
Result: The main menu is displayed.
- 2 Press the **▼** or **▲** button to select **Setup**.
Result: The options available in the **Setup** group are displayed.
- 3 Press the **ENTER** () button.
- 4 Press the **▼** or **▲** button to select **Plug & Play**. Press the **ENTER** () button.
Result: The message **Plug & Play** is displayed.
- 5 For further details on how to set, refer to the opposite page.

Choosing Your Language

When you start using your television for the first time, you must select the language which will be used for displaying menus and indications.











- 1 Press the **MENU** () button.
Result: The main menu is displayed.
- 2 Press the **▼** or **▲** button to select **Setup**.
Result: The options available in the **Setup** group are displayed.
- 3 Press the **ENTER** () button.
- 4 Press the **▼** or **▲** button to select **Language**. Press the **ENTER** () button.
Result: The languages available are listed.
- 5 Select the appropriate language by pressing the **▼** or **▲** button.
- 6 Press the **ENTER** () button to confirm your choice.
- 7 When you are satisfied with your choice, press the **EXIT** () button to return to normal viewing.

Storing Channels Automatically

ENG

You can scan for the frequency ranges available to you, (availability depends on your country). Automatically allocated programme numbers may not correspond to actual or desired programme numbers. However you can sort numbers manually and clear any channels you do not wish to watch.

- 1 Press the **MENU** () button.
Result: The main menu is displayed.
- 2 Press the **▼** or **▲** button to select **Channel1**.
Result: The options available in the **Channel** group are displayed.
- 3 Press the **ENTER** () button.
- 4 Press the **▼** or **▲** button to select **Area**. Press the **ENTER** () button.
Result: The areas available are listed.
- 5 Select your country (or area) by pressing the **▼** or **▲** button.
- 6 Press the **ENTER** () button to confirm your choice
- 7 Press the **▼** or **▲** button to select **Auto Store**. Press the **ENTER** () button.
Result: The **Auto Store** menu is displayed.
- 8 Select the **Start** and press the **ENTER** () button to start the search.
Result: The search will end automatically. Channels are sorted and stored in an order which reflects their position in the frequency range, (with lowest first and highest last). The programme originally selected is then displayed.
➤ To stop the search before it has finished, press the **EXIT** () or **ENTER** () button.
- 9 When the channels have been stored, you can:
 - ◆ Sort them in the order required (see page 21)
 - ◆ Clear a channel (see page 20)
 - ◆ Fine-tune channel reception if necessary (see page 29)
 - ◆ Assign a name to the stored channels (see page 22)
 - ◆ Activate/deactivate the Digital Noise Reduction feature (see page 33)

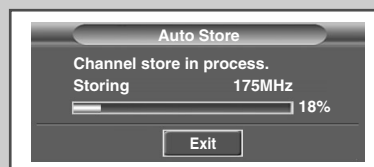
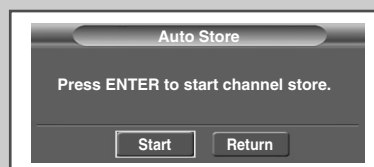

Storing Channels Manually

ENG



You can store up to television channels, including those received via cable networks.

When storing channels manually, you can choose:

- ◆ Whether or not to store each of the channels found
- ◆ The programme number of each stored channel which you wish to identify

- 1 Press the **MENU** () button.
Result: The main menu is displayed.
- 2 Press the **▼** or **▲** button to select **Channel**.
Result: The options available in the **Channel** group are displayed.
- 3 Press the **ENTER** () button.
- 4 Press the **▼** or **▲** button to select **Manual Store**. Press the **ENTER** () button.
Result: The **Manual Store** menu is displayed.
- 5 If necessary, select the broadcasting standard required. Press the **◀** or **▶** button to select **Color System** and press the **▼** or **▲** button. The colour standards are displayed in the following order. (depending on the model).
 - ◆ **AUTO - PAL - SECAM**
 - ◆ **AUTO - NTSC3.58 - NTSC4.43 - PAL60**
- 6 Press the **◀** or **▶** button to select **Sound System** and press the **▼** or **▲** button. The sound standards are displayed in the following order. (depending on the model).
 - ◆ **BG - DK - I - M**

Storing Channels Manually (continued)

ENG

- 7** If you know the number of the channel to be stored, see the following steps.
- ◆ Press the ◀ or ▶ button to select **Channel1**.
 - ◆ Press the ▼ or ▲ button to select **C** (Air channel) or **S** (Cable channel).
 - ◆ Press the ▶ button.
 - ◆ Press the numeric buttons (0~9) to select indicate the required number.
- If no sound or abnormal sound, re-select the sound standard required.

- 8** If you do not know the channel numbers, select the **Search** by pressing the ◀ or ▶ button. Press the ▼ or ▲ button to start the search.

Result: The tuner scans the frequency range until the first channel or the channel that you selected is received on your screen.

- 9** To assign a programme number to a channel, select the **Prog.** by pressing the ◀ or ▶ button. Press the ▼ or ▲ button until you find the correct number.

- 10** To store the channel and associated programme number, select the **Store** by pressing the ◀ or ▶ button. Press the **ENTER** (↵) button.

Result: The ? will be changed to **OK**.

- 11** Repeat Steps 7 to 10 for each channel to be stored.



Channel mode

- ◆ **P** (Programme mode): When completing tuning, the broadcasting stations in your area have been assigned to position numbers from P00 to max P99. You can select a channel by entering the position number in this mode.
- ◆ **C** (Real channel mode): You can select a channel by entering the assigned number to each air broadcasting station in this mode.
- ◆ **S** (Cable channel mode): You can select a channel by entering the assigned number for each cable channel in this mode.

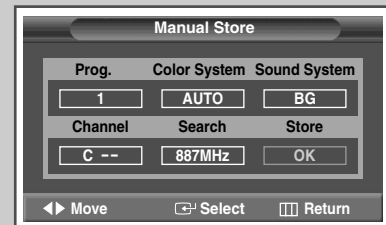
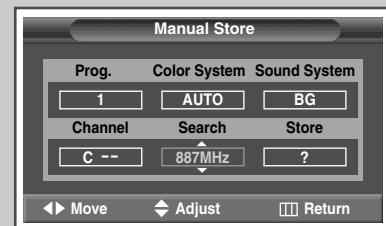
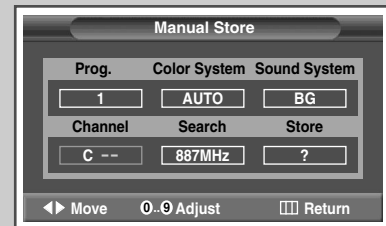
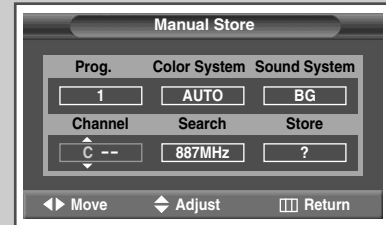

Skipping Unwanted Channels

ENG

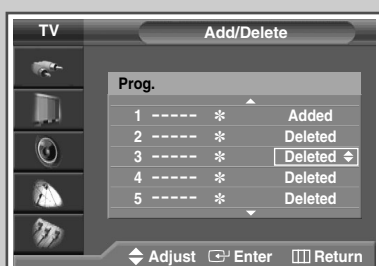
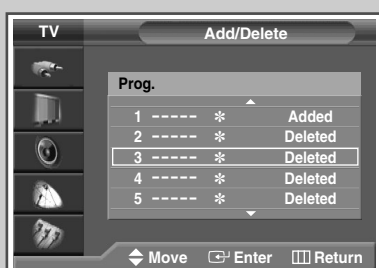

◆ *Skipping unwanted channels*

You can exclude the channels of your choice from the channel scan operation. When you scan through the stored channels, those that you have chosen to skip are thus not displayed. All channels that you do not specifically choose to skip are displayed during scanning.

- 1 Press the **MENU** () button.
Result: The main menu is displayed.

- 2 Press the **▼** or **▲** button to select **Channel1**.
Result: The options available in the **Channel1** group are displayed.

- 3 Press the **ENTER** () button.

- 4 Press the **▼** or **▲** button to select **Edit**. Press the **ENTER** () button.
Result: The **Edit** menu is displayed.

- 5 Press the **▼** or **▲** button to select **Add/Delete**. Press the **ENTER** () button.
Result: The **Add/Delete** menu is displayed with the current channel automatically selected.

- 6 Press the **▼** or **▲** button to select the channel to be deleted.

- 7 Press the **ENTER** () button to **Add/Delete**. To add or delete the channel, select **Added** or **Deleted** by pressing the **▼** or **▲** button. Press the **ENTER** () button to confirm.

Sorting the Stored Channels

ENG

This operation allows you to change the programme numbers of stored channels. This operation may be necessary after using ATM. You can delete those channels you do not want to keep.

- 1 Press the **MENU** () button.
Result: The main menu is displayed.

- 2 Press the **▼** or **▲** button to select **Channel1**.
Result: The options available in the **Channel1** group are displayed.

- 3 Press the **ENTER** () button.

- 4 Press the **▼** or **▲** button to select **Edit**. Press the **ENTER** () button.
Result: The **Edit** menu is displayed.

- 5 Press the **▼** or **▲** button to select **Sort**. Press the **ENTER** () button.
Result: The **Sort** menu is displayed.

- 6 Select the channel that you wish to move by pressing the **▼** or **▲** button. Press the **ENTER** () button.

- 7 Select the number of the programme to which the channel is to be moved by pressing the **▼** or **▲** button. Press the **ENTER** () button.
Result: The channel is moved to its new position and all other channels are shifted accordingly.

- 8 Repeat Steps 6 to 7 until you have moved all the channels to the required programme numbers.

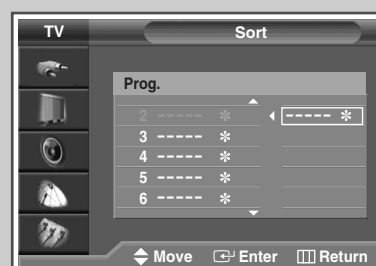
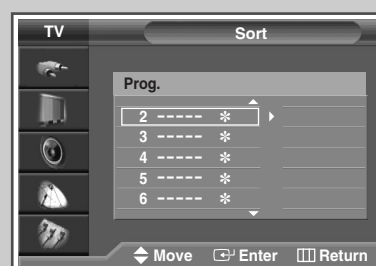

Assigning Names to Channels

ENG

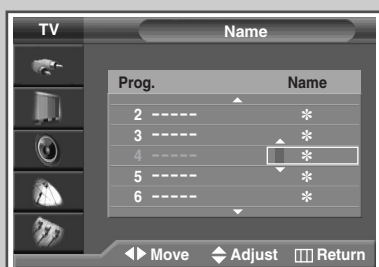

Channel names will be assigned automatically when channel information is broadcast. These names can be changed, allowing you to assign new names.

- 1 Press the **MENU** () button.
Result: The main menu is displayed.

- 2 Press the **▼** or **▲** button to select **Channel**.
Result: The options available in the **Channel** group are displayed.

- 3 Press the **ENTER** () button.

- 4 Press the **▼** or **▲** button to select **Edit**. Press the **ENTER** () button.
Result: The **Edit** menu is displayed.

- 5 Press the **▼** or **▲** button to select **Name**. Press the **ENTER** () button.
Result: The **Name** menu is displayed with the current channel automatically is selected.

- 6 If necessary, select the channel to be assigned a new name by pressing the **▼** or **▲** button. Press the **ENTER** () button.
Result: Arrow indications are displayed around the name box.

- 7 Press the **▼** or **▲** button to select a letter (A-Z), a number (0-9) or a symbol (-, space). Move on the previous or next letter by pressing the **◀** or **▶** button.







- 8 When you have finished entering the name, press the **ENTER** () button to confirm the name.

Activating the Child Lock

ENG

◆ Activating the child lock

This feature allows you to lock the television so that it cannot be switched on via the front panel. It can, however, still be switched on via the remote control. Thus, by keeping the remote control away from unauthorised users, such as children, you can prevent them from watching unsuitable programme.

- 1 Press the **MENU** () button.
Result: The main menu is displayed.
- 2 Press the **▼** or **▲** button to select **Channel**.
Result: The options available in the **Channel** group are displayed.
- 3 Press the **ENTER** () button.
- 4 Press the **▼** or **▲** button to select **Edit**. Press the **ENTER** () button.
Result: The **Edit** menu is displayed.
- 5 Press the **▼** or **▲** button to select **Child Lock**. Press the **ENTER** () button.
Result: The **Child Lock** menu is displayed with the current channel automatically is selected.
- 6 Press the **▼** or **▲** button to select the channel to be locked.
- 7 Press the **ENTER** () button. To lock the channel, select **Locked** by pressing the **▼** or **▲** button (to unlock the channel, select **Unlocked**). Press the **ENTER** () button to confirm.

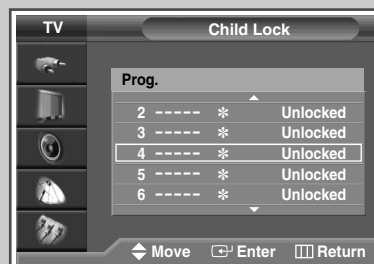

Selecting a Channel by Information

ENG

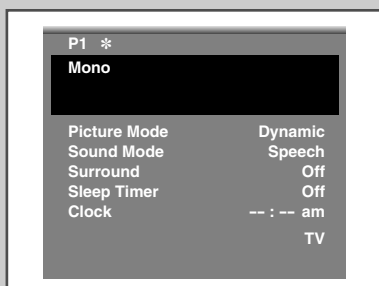
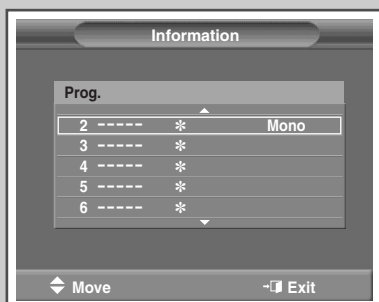
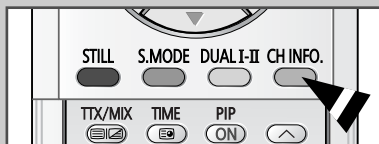

You can display the list of stored channels.

- 1 Press the **CH INFO.** button.

Result: A list is displayed with the first 5 channels. Two text boxes to the right of the list indicate:

- ◆ Whether the Teletext feature is available.
- ◆ Which sound mode is being used.

- 2 To scroll through the stored channels, press the ▼ or ▲ button.

Result: The corresponding channel is displayed.

- 3 Press the **EXIT** (→) button to select a specific channel.





Result: The corresponding channel is displayed and the **Information** box disappears.

- ◆ External inputs can be displayed and scrolled through in the same way.
- ◆ You can display the name of the channel or input by pressing the **INFO** (□+) button.

Changing the Picture Standard

ENG

You can select the type of picture which best corresponds to your viewing requirements.

- 1 Press the **MENU** () button.
Result: The main menu is displayed.
- 2 Press the **▼** or **▲** button to select **Picture**.
Result: The options available in the **Picture** group are displayed.
- 3 Press the **ENTER** () button.
Result: The **Mode** is selected.
- 4 Press the **ENTER** () button again.
Result: The options available are listed.
- 5 Select the option by pressing the **▼** or **▲** button.
Result: The following modes are available depending on the input source.
 - ◆ **Dynamic - Standard - Movie - Custom**
 - ◆ **High - Middle - Low - Custom** (PC or DVI Mode).
- 6 Press the **ENTER** () button to confirm.

➤ You can also set these options simply by pressing the **P.MODE** (Picture Mode) button.

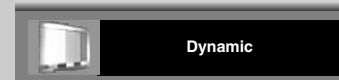
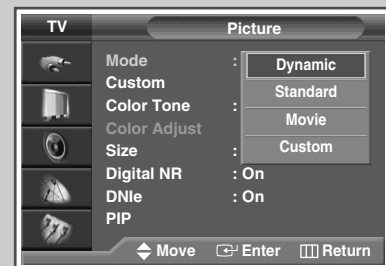
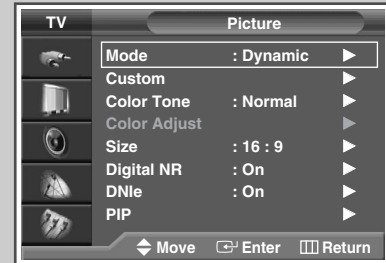

Adjusting the Picture Settings

ENG

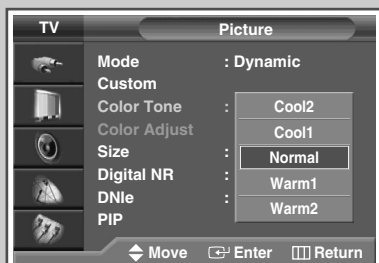
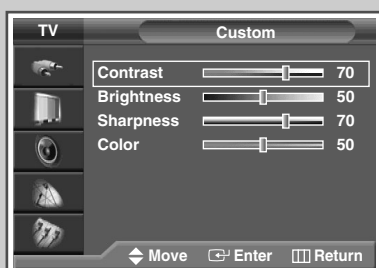
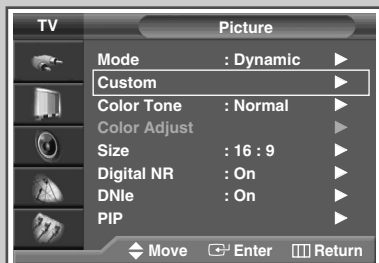

Your television has several settings which allow you to control picture quality.

- 1 Press the **MENU** () button.
Result: The main menu is displayed.

- 2 Press the **▼** or **▲** button to select **Picture**.
Result: The options available in the **Picture** group are displayed.

- 3 Press the **ENTER** () button.

- 4 Select the required option (**Custom**, **Color Tone**) pressing the **▼** or **▲** button.

- 5 Press the **▼** or **▲** button to select **Custom**. Press the **ENTER** () button.
Result: The **Custom** menu is displayed.

- 6 Press the **ENTER** () button to change the setting. The options are displayed in the following order.
 - ◆ **Custom** : **Contrast**, **Brightness**, **Sharpness**, **Color**
 - The horizontal bar is displayed. Move the horizontal bar's cursor left or right by pressing the **◀** or **▶** button.
 - When the picture mode is set to **Custom**, the value of these option may vary be changed depending on the input source (ex. RF, Video, Component, PC or DVI).
 - If you make any changes to these settings, the picture standard is automatically switched to the **Custom**
 - ◆ **Color Tone** : **Cool2**, **Cool1**, **Normal**, **Warm1**, **Warm2**

- 7 When you are satisfied with the settings, press the **EXIT** () button to return to normal viewing.

Adjusting the Picture Settings (PC or DVI Mode)

➤ Preset to the PC or DVI mode by using the **SOURCE** button.

- 1 Press the **MENU** () button.
Result: The main menu is displayed.

- 2 Press the **▼** or **▲** button to select **Picture**.
Result: The options available in the **Picture** group are displayed.

- 3 Press the **ENTER** () button.

- 4 Press the **▼** or **▲** button to select **Custom**. Press the **ENTER** () button.
Result: The **Custom** menu is displayed.

- 5 Press the **▼** or **▲** button to select the option (**Contrast**, **Brightness**) to be adjusted. Press the **ENTER** () button.
Result: The horizontal bar is displayed. Move the horizontal bar's cursor left or right by pressing the **◀** or **▶** button.

- 6 Press the **ENTER** () button to confirm.

- 7 Press the **MENU** () button.
Result: The options available in the **Picture** group are displayed again.

- 8 Press the **▼** or **▲** button to select **Color Tone**. Press the **ENTER** () button.
Result: The options available are listed.

- 9 Select the option by pressing the **▼** or **▲** button. The following colour tones are displayed.

Cool - Normal - Warm - Custom

- 10 Press the **ENTER** () button to confirm your choice

- 11 Press the **▼** or **▲** button to select **Color Adjust**. Press the **ENTER** () button.
Result: The **Color Adjust** menu is displayed.

- 12 Press the **▼** or **▲** button to select the option (**Red**, **Green**, **Blue**) to be adjusted. Press the **ENTER** () button.
Result: The horizontal bar is displayed. Move the horizontal bar's cursor left or right by pressing the **◀** or **▶** button.

- 13 Press the **ENTER** () button to confirm your choice

- 14 When you are satisfied with the settings, press the **EXIT** () button to return to normal viewing.

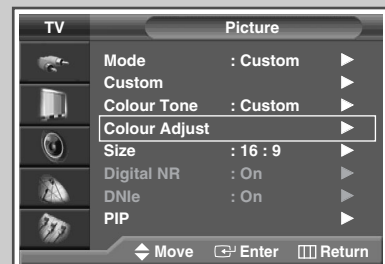
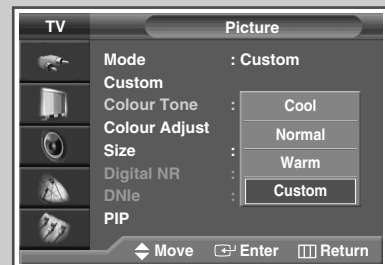
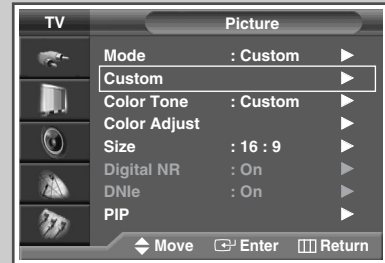





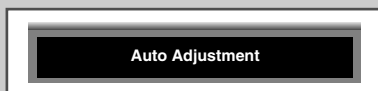
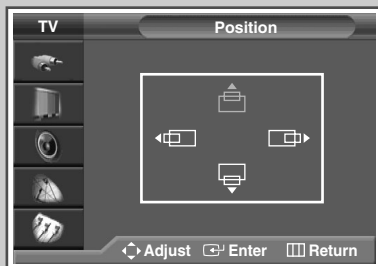
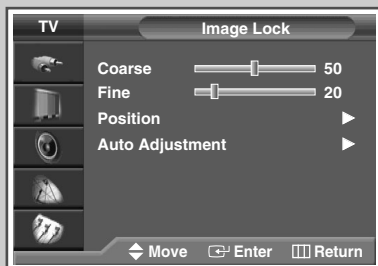





ENG

Setting the Picture (PC Mode)





➤ Preset to the PC mode by using the **SOURCE** button.

- 1 Press the **MENU** () button.
Result: The main menu is displayed.
- 2 Press the **▼** or **▲** button to select **Setup**.
Result: The options available in the **Setup** group are displayed.
- 3 Press the **ENTER** () button.
- 4 Press the **▼** or **▲** button to select **Image Lock**.
Press the **ENTER** () button.
- 5 Press the **▼** or **▲** button to select the option (**Coarse**, **Fine**) to be adjusted. Press the **ENTER** () button.
Result: The horizontal bar is displayed. Move the horizontal bar's cursor left or right by pressing the **◀** or **▶** button.
- 6 Press the **ENTER** () button to confirm your choice
- 7 Press the **MENU** () button.
Result: The options available in the **Image Lock** group are displayed again.
- 8 Press the **▼** or **▲** button to select **Position**.
Press the **ENTER** () button.
Result: The options available in the **Position** group are displayed.
- 9 Adjust the position by using the **▼**, **▲**, **◀**, or **▶** button.
- 10 Press the **MENU** () button.
Result: The options available in the **Image Lock** group are displayed again.
- 11 To adjust the screen quality and position automatically, select the **Auto Adjustment** by pressing the **▼** or **▲** button.
Press the **ENTER** () button.
Result: The **Auto Adjustment** is displayed. The screen quality and position are automatically adjusted.
- 12 When you are satisfied with the settings, press the **EXIT** () button to return to normal viewing.

Using the Fine Tune

ENG

If reception is weak, you can fine tune a channel manually.

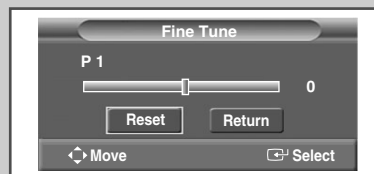
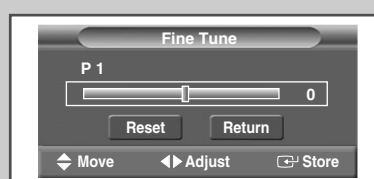

- 1 Press the **MENU** () button.
Result: The main menu is displayed.
- 2 Press the **▼** or **▲** button to select **Channel1**.
Result: The options available in the **Channel1** group are displayed.
- 3 Press the **ENTER** () button.
- 4 Press the **▼** or **▲** button to select **Fine Tune**. Press the **ENTER** () button.
Result: The horizontal bar is displayed. Move the horizontal bar's cursor left or right by pressing the **◀** or **▶** button to reach the required setting.
- 5 Press the **◀** or **▶** button until the picture and sound are both clear and sharp.

➤ If you are unable to fine tune a channel, check that the **Color System** and **Sound System** settings are correct.

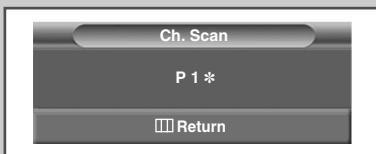

Viewing the Channel Scan Picture



- 1 Press the **MENU** () button.
Result: The main menu is displayed.
- 2 Press the **▼** or **▲** button to select **Channel**.
Result: The options available in the **Channel** group are displayed.
- 3 Press the **ENTER** () button.
- 4 Press the **▼** or **▲** button to select **Ch. Scan**. Press the **ENTER** () button.
Result: You can view every memorized channel in order.

Freezing the Current Picture

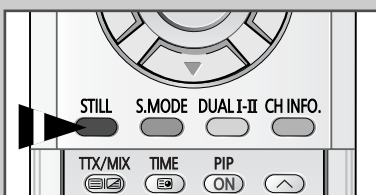

You can freeze the picture when watching a television programme simply by pressing the "STILL" button. To return to normal viewing, press it again.





- In the PIP mode, the main and sub pictures are stilled at the same time.

Using the LNA (Low Noise Amplifier) Feature

ENG

This function is very useful in the situation that the TV is used in weak signal. LNA amplifies the TV signal in the weak signal area, but not noise.

This feature is working only weak signal condition, and that is memorized on current channel, additional.

- 1 Press the **MENU** () button.
Result: The main menu is displayed.
- 2 Press the **▼** or **▲** button to select **Channel1**.
Result: The options available in the **Channel1** group are displayed.
- 3 Press the **ENTER** () button.
- 4 Press the **▼** or **▲** button to select **LNA**. Press the **ENTER** () button.
Result: The options available are listed.
- 5 Select the required channel by pressing the **▼** or **▲** button. Press the **ENTER** () button.
- 6 Select **On** or **Off** by pressing the **▼** or **▲** button. Press the **ENTER** () button to confirm.

-
- ◆ If the picture is noisy with the **LNA** set to **On**, select **Off**.
 - ◆ LNA setting is to be made for each channel.



Selecting the Picture Size

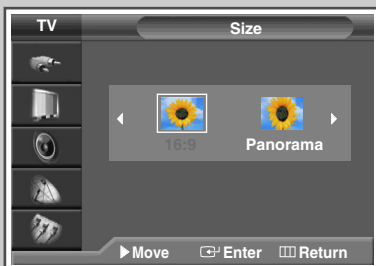
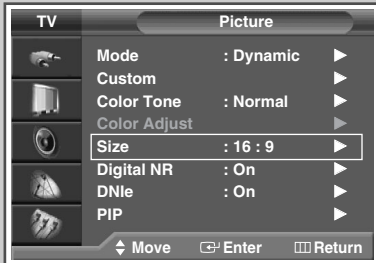

ENG

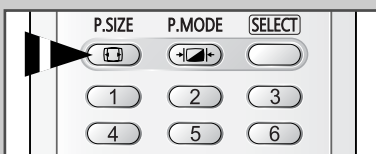
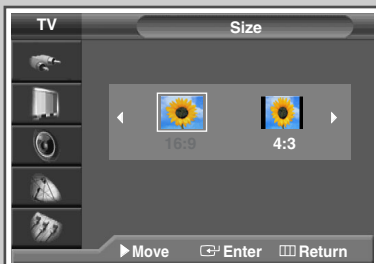

PC Mode



You can select the picture size which best corresponds to your viewing requirements.

- 1 Press the **MENU** () button.
Result: The main menu is displayed.
- 2 Press the **▲** or **▼** button until the **Picture** is selected.
Result: The options available in the **Picture** group are displayed.
- 3 Press the **ENTER** () button.
- 4 Press the **▲** or **▼** button until the **Size** is selected. Press the **ENTER** () button.

Result: The following modes are available: (depending on the model)

- ◆ **16:9 - Panorama - Zoom 1 - Zoom 2 - Stretch - 14:9 - 4:3**
- ◆ **16:9 - 4:3 (PC Mode)**





16:9	Sets the picture to 16:9 wide mode.
Panorama	Use this mode for the wide aspect ratio of a panoramic picture.
Zoom1	Magnify the size of the picture vertically on screen.
Zoom2	Magnify the size of the picture more than Zoom1 .
Stretch	Using this mode, magnify the picture vertically and horizontally to be bigger than the picture in Zoom2 .
14:9	Magnify the size of the picture more than 4:3.
4:3	Normal 4:3 ratio picture.

- 5 Press the **ENTER** () button to confirm.

- ◆ You can select these options by simply pressing the **P.SIZE** () button on the remote control. At this time, lifting is available in the **Zoom1** or **Zoom2** mode by pressing the **▲** or **▼** button.
- ◆ The picture size can not be changed in the PIP mode.

Using the Digital NR (Digital Noise Reduction) Feature

If the signal received by your television is weak, you can activate this feature to help reduce any static and ghosting that may appear on the screen.

- 1 Press the **MENU** () button.
Result: The main menu is displayed.
- 2 Press the **▲** or **▼** button until the **Picture** is selected.
Result: The options available in the **Picture** group are displayed.
- 3 Press the **ENTER** () button.
- 4 Press the **▲** or **▼** button until the **Digital NR** is selected. Press the **ENTER** () button.
- 5 Select **off** or **On** by pressing the **▲** or **▼** button. Press the **ENTER** () button to confirm.

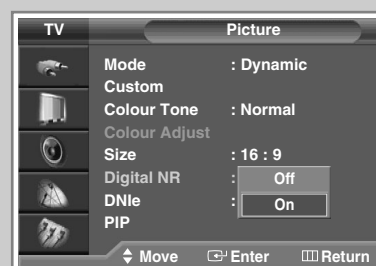
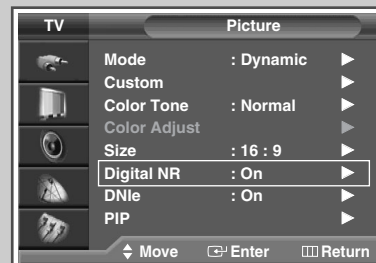



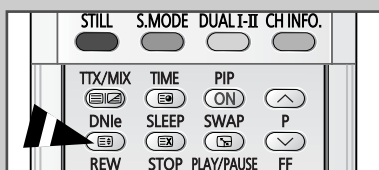
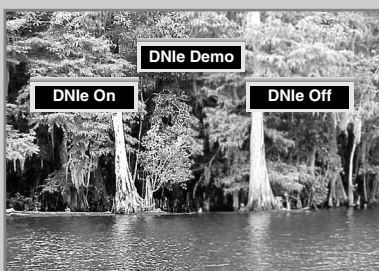
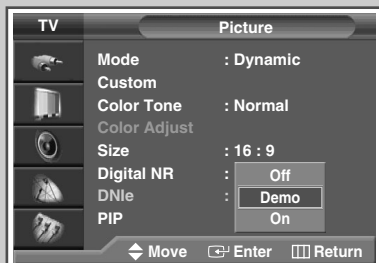

ENG

DNle™ (Digital Natural Image engine) DNle™

ENG





This feature bring you more detailed image with 3D noise reduction, detail enhancement, contrast enhancement and white enhancement. New image compensation Algorithm gives brighter, clearer, much detailed image to you. DNle™ technology will fit every signals into your eyes..

- 1 Press the **MENU** () button.
Result: The main menu is displayed.
- 2 Press the **▼** or **▲** button to select **Picture**.
Result: The options available in the **Picture** group are displayed.
- 3 Press the **ENTER** () button.
- 4 Press the **▼** or **▲** button to select **DNle**. Press the **ENTER** () button.
- 5 Press the **▼** or **▲** button to change the setting. Press the **ENTER** () button to confirm.
 - ◆ **On:** Switches on the DNle mode.
 - ◆ **Demo (Option):** The screen before applying DNle appears on the right and the screen after applying DNle appears on the left.
 - ◆ **Off:** Switches off the DNle mode.

➤ You can also set these options simply by pressing the **DNle** button.

Setting the Blue Screen



If no signal is being received or the signal is very weak, a blue screen automatically replaces the noisy picture background. If you wish to continue viewing the poor picture, you must set the "Blue Screen" mode to "Off".

- 1 Press the **MENU** () button.
Result: The main menu is displayed.
- 2 Press the **▼** or **▲** button to select **Setup**.
Result: The options available in the **Setup** group are displayed.
- 3 Press the **ENTER** () button.
- 4 Press the **▼** or **▲** button to select **Blue Screen**. Press the **ENTER** () button.
- 5 Press the **▼** or **▲** button to change the setting. (**On** or **Off**).



Selecting the Film Mode

You can automatically sense and process film signals from all sources and adjust the picture for optimum quality.

- 1 Press the **MENU** () button.
Result: The main menu is displayed.
- 2 Press the **▼** or **▲** button to select **Setup**.
Result: The options available in the **Setup** group are displayed.
- 3 Press the **ENTER** () button.
- 4 Press the **▼** or **▲** button to select **Film Mode**. Press the **ENTER** () button.
- 5 Press the **▼** or **▲** button to change the setting. (**Off** or **On**).
 - ◆ **On** : Automatically senses and processes film signals from all sources and adjusts the picture for optimum quality.
 - ◆ **Off** : Switches off the **Film Mode**.





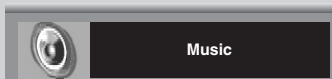
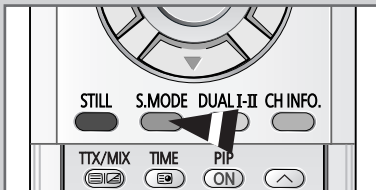
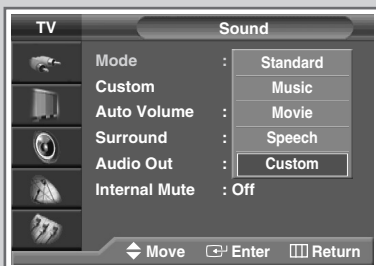
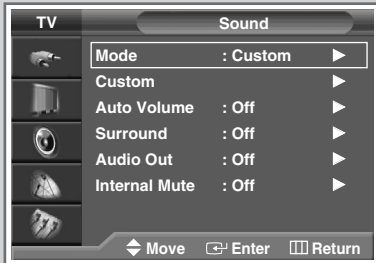

➤ Not available in TV, PC or DVI modes.

Changing the Sound Standard

ENG





You can select the type of special sound effect to be used when watching a given broadcast.

- 1 Press the **MENU** () button.
Result: The main menu is displayed.
- 2 Press the **▼** or **▲** button to select **Sound**.
Result: The options available in the **Sound** group are displayed.
- 3 Press the **ENTER** () button.
Result: The **Mode** is selected.
- 4 Press the **ENTER** () button again.
- 5 Select the option by pressing the **▼** or **▲** button. The sound effects are displayed in the following order.
Standard - Music - Movie - Speech - Custom.
- 6 Press the **ENTER** () button to confirm.

➤ You can also set these options simply by pressing the **S.MODE** (Sound Mode) button.

Adjusting the Sound Settings

The sound settings can be adjusted to suit your personal preferences.

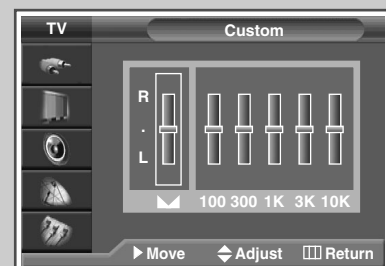
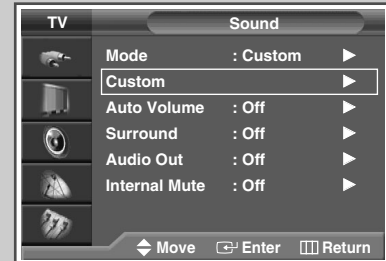

- 1 Press the **MENU** () button.
Result: The main menu is displayed.
- 2 Press the **▼** or **▲** button to select **Sound**.
Result: The options available in the **Sound** group are displayed.
- 3 Press the **ENTER** () button.
- 4 Press the **▼** or **▲** button to select **Custom**. Press the **ENTER** () button.
Result: The **Custom** menu is displayed with the current option.
- 5 Select the option to be adjusted by pressing the **◀** or **▶** button. Press the **▼** or **▲** button to reach the required setting.

➤ If you make any changes to the equalizer settings, the sound standard is automatically switched to the **Custom**.



Adjusting the Volume Automatically

Each broadcasting station has its own signal conditions, and so it is not easy for you to adjust the volume every time the channel is changed. This feature lets you automatically adjust the volume of the desired channel by lowering the sound output when the modulation signal is high or by raising the sound output when the modulation signal is low.

- 1 Press the **MENU** () button.
Result: The main menu is displayed.
- 2 Press the **▼** or **▲** button to select **Sound**.
Result: The options available in the **Sound** group are displayed.
- 3 Press the **ENTER** () button.
- 4 Press the **▼** or **▲** button to select **Auto Volume**. Press the **ENTER** () button.
- 5 Select the option (**Off** or **On**) by pressing the **▼** or **▲** button.

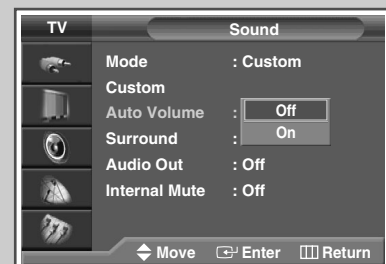
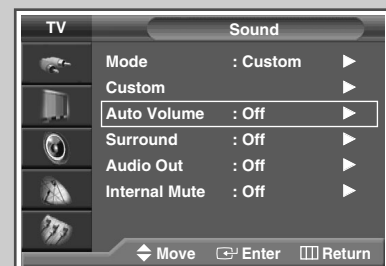

Setting the Dolby Pro Logic

ENG

Rear of the TV

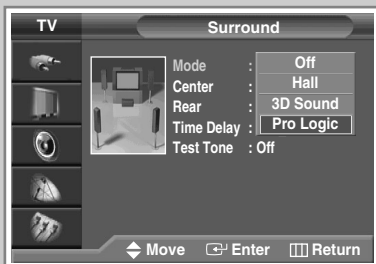
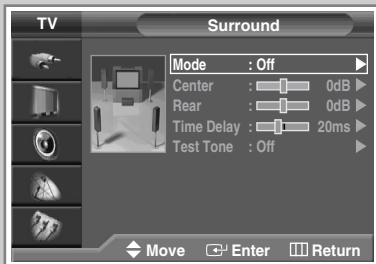
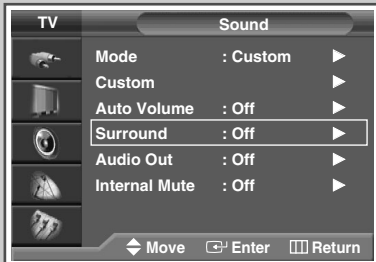
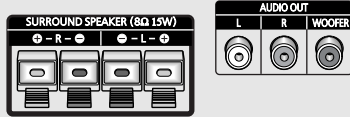

This mode allows you enjoy Dolby Pro Logic Surround effect fully with only surround speakers are connected to TV. This allows various modes for the main, center and rear speakers to be selected.

Surround Mode	Input Signal	Speakers		
		Main	Centre	Rear
Pro Logic	Stereo	✓	✓	✓
	Mono		✓	
3D Sound	Stereo	✓		
	Mono	✓		
Hall	Stereo	✓		
	Mono	✓		
Off	Stereo	✓		
	Mono	✓		

➤ ✓ ; Sound

1 Press the **MENU** () button.

Result: The main menu is displayed.

2 Press the **▼** or **▲** button to select **Sound**.

Result: The options available in the **Sound** group are displayed.

3 Press the **ENTER** () button.

4 Press the **▼** or **▲** button to select **Surround**. Press the **ENTER** () button.

Result: The **Surround** menu is displayed with the **Mode** is selected.

5 Press the **ENTER** () button.

Result: The options available are listed.

6 Select the option by pressing the **▼** or **▲** button. The surround modes are displayed in the following order.

Off - Hall - 3D Sound - Pro Logic

➤ Woofer sound is not available in **Hall** mode.

7 If you select the **Pro Logic**, the options available are displayed.





➤ Manufactured under license from Dolby Laboratories. "Dolby", "Pro Logic", and the double-D symbol are trademarks of Dolby Laboratories.

Adjusting Your Dolby Preferences

ENG

The following Dolby settings can be adjusted to suit your personal preferences.

- ◆ *Volume of the centre and rear speakers*
- ◆ *Pro Logic delay time for the rear speakers (between 15 and 30 ms)*
- ◆ *Activation/deactivation of the test tone to simulate the volume on each speaker*

- 1 Press the **MENU** () button.
Result: The main menu is displayed.
- 2 Press the **▼** or **▲** button to select **Sound**.
Result: The options available in the **Sound** group are displayed.
- 3 Press the **ENTER** () button.
- 4 Press the **▼** or **▲** button to select **Surround**. Press the **ENTER** () button.
Result: The **Surround** menu is displayed with the current option.
- 5 Select the option (**Center**, **Rear**, **Time Delay**, **Test Tone**) by pressing the **▼** or **▲** button. Press the **◀** or **▶** button to reach the required setting.
- 6 When you are satisfied with the settings, press the **EXIT** () button to return to normal viewing.

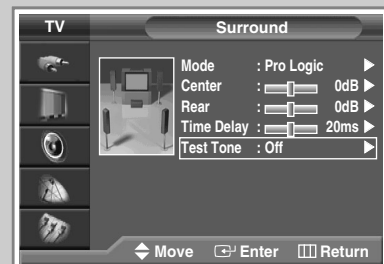
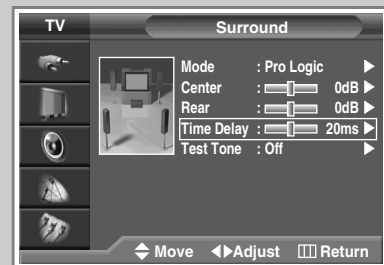
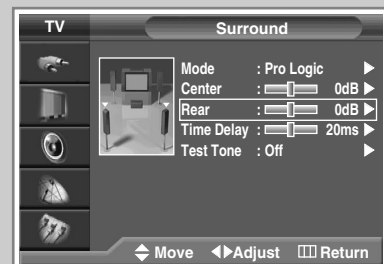
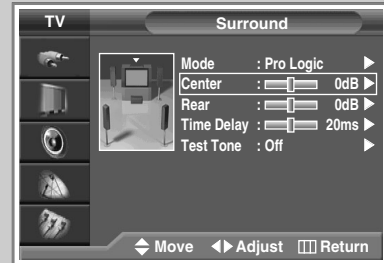





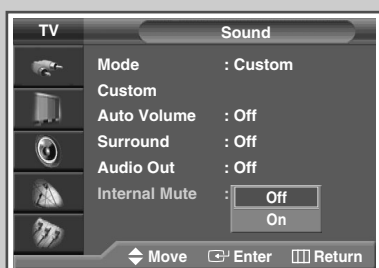
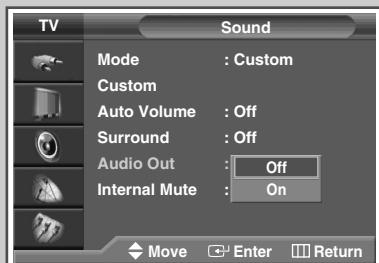

Setting the External Sound

ENG



This feature allows you can adjust to suit your personal preferences when the equipment with output is connected to the television.

- 1 Press the **MENU** () button.
Result: The main menu is displayed.
- 2 Press the **▼** or **▲** button to select **Sound**.
Result: The options available in the **Sound** group are displayed.
- 3 Press the **ENTER** () button.
- 4 Press the **▼** or **▲** button to select **Audio Out**. Press the **ENTER** () button.
- 5 Select the required option (**Off** or **On**) by pressing the **▼** or **▲** button.
 - ◆ If you want to adjust the volume level with the volume control on the TV or external amplifier, set to **Off**.
 - ◆ If you set to **On**...
 - You can adjust the volume level with the volume control on the audio amplifier. And the **Internal Mute** is set to **On** automatically, and you can not select it.
 - The volume control buttons (**MUTE**, , ) of the television and remote control do not work.
- 6 Press the **ENTER** () button to confirm.
- 7 Press the **▼** or **▲** button to select **Internal Mute**.
If you set to **On**, no sound outputs of all internal and external speakers.
 - When the **Audio Out** is set to **Off**, you can select the **Internal Mute** and control it.

Selecting the Sound Mode (depending on the model)

ENG

The “DUAL I-II” button displays/controls the processing and output of the audio signal. When power is switched on, the mode is automatically preset to either “Dual-I ” or “Stereo”, depending on the current transmission.

	Type of broadcast	On-screen indication
NICAM Stereo	Regular broadcast (Standard audio)	Mono (Normal use)
	Regular + NICAM Mono	NICAM Mono ↔ Mono
	NICAM Stereo	NICAM Stereo ↔ Mono (Forced mono)
	NICAM Dual-I/II	NICAM Dual-I → NICAM Dual-II → Mono
A2 Stereo	Regular broadcast (Standard audio)	Mono
	Bilingual or Dual-I/II	Dual-I ↔ Dual-II
	Stereo	Stereo ↔ Mono (Forced mono)

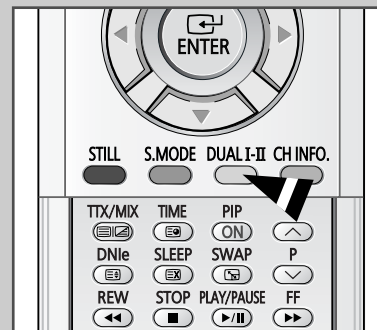



- ◆ If the receiving conditions deteriorate, listening will be easier if the mode is set to the **Mono**.
- ◆ If the stereo signal is weak and an automatic switching occurs, then switch to the **Mono**.
- ◆ When receiving a mono sound in the AV mode, connect to the “AUDIO-L” input connector on the side of the television. If the mono sound comes out only from left speaker, press the **DUAL I-II** button.

Setting the Melody Sound

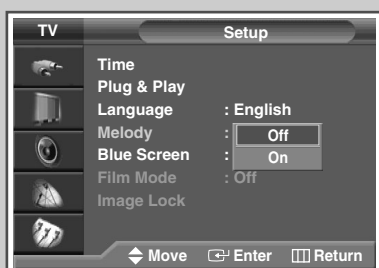
ENG







You can hear clear melody sound when the television is powered on or off.

- 1 Press the **MENU** () button.
Result: The main menu is displayed.
- 2 Press the **▼** or **▲** button to select **Setup**.
Result: The options available in the **Setup** group are displayed.
- 3 Press the **ENTER** () button.
- 4 Press the **▼** or **▲** button to select **Melody**. Press the **ENTER** () button.
- 5 Select the option (**Off** or **On**).

Setting the Sleep Timer

You can select a time period of between 30 and 180 minutes after which the television automatically switches to Standby mode.

- 1 Press the **MENU** () button.
Result: The main menu is displayed.
- 2 Press the **▼** or **▲** button to select **Setup**.
Result: The options available in the **Setup** group are displayed.
- 3 Press the **ENTER** () button.
- 4 Press the **▼** or **▲** button to select **Time**. Press the **ENTER** () button..
Result: The options available in the **Time** group are displayed.
- 5 Press the **▼** or **▲** button to select **Sleep Timer**. Press the **ENTER** () button.
Result: The **Sleep Timer** menu is displayed with the **Min.** is selected.
- 6 Select the preset time intervals (**Off**, **30**, **60**, **90**, **120**, **150**, **180**) by pressing the **▼** or **▲** button.
- 7 When you are satisfied with the settings, select **Activation** to **Yes** or **No** by pressing the **▼** or **▲** button.
- 8 Press the **ENTER** () button to confirm your selection.

- ◆ You can also set these options simply by pressing the **SLEEP** button.
- ◆ If the sleep timer is not yet set, **Off** is displayed. If the sleep timer is already set, the remaining time before which the television switches to Standby mode is displayed.
- Power Off : TV automatically turns off when it receives no input signal for 15 minutes or longer.

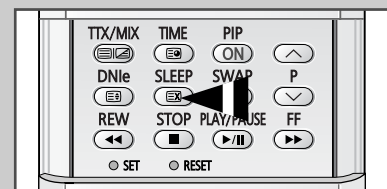

ENG







Setting and Displaying the Current Time

ENG



You can set the television's clock so that the current time is displayed by pressing the "INFO ()" button. You must also set the time if you wish to use the automatic on or off timers.

➤ When pressing the "I" button (On/Off) on the front of the television, the clock setting will be reset.







- 1 Press the **MENU** () button.
Result: The main menu is displayed.
- 2 Press the ▼ or ▲ button to select **Setup**.
Result: The options available in the **Setup** group are displayed.
- 3 Press the **ENTER** () button.
- 4 Press the ▼ or ▲ button to select **Time**. Press the **ENTER** () button.
Result: The options available in the **Time** group are displayed with **Clock** is selected.
- 5 Press the **ENTER** () button.
- 6 Press the ◀ or ▶ button to move to the **Hour**, **Min** (Minute) or **am/pm**. Set the hour or minute by pressing the ▼ or ▲ button.
- 7 When you have finished, press the **ENTER** () button to exit.
- 8 Press the **INFO** () button to display the current time.

Switching the Television On and Off Automatically

ENG

You can set the television's clock and set the On or Off timers so that the television will:

- ◆ Switch on automatically and tune to the channel of your choice at the time you select
 - ◆ Switch off automatically at the time you select
- The first step is to set the television's clock (refer to "Setting and Displaying the Current Time" on the previous page).

- 1 Press the **MENU** () button.
Result: The main menu is displayed.
- 2 Press the **▼** or **▲** button to select **Setup**.
Result: The options available in the **Setup** group are displayed.
- 3 Press the **ENTER** () button.
- 4 Press the **▼** or **▲** button to select **Time**. Press the **ENTER** () button.
Result: The options available in the **Time** group are displayed.
- 5 Press the **▼** or **▲** button to select **On Timer**. Press the **ENTER** () button.
Result: The options available in the **On Timer** group are displayed.
- 6 Select the **Hour**, **Min.**, **Prog.**, **Volume** by pressing the **◀** or **▶** button.
Set these by pressing the **▼** or **▲** button.
- 7 When you are satisfied with the settings, select **Activation** to **Yes** or **No** by pressing the **▼** or **▲** button.
- 8 Press the **MENU** () button.
Result: The options available in the **Time** group are displayed again.
- 9 Press the **▼** or **▲** button to select **Off Timer**. Press the **ENTER** () button.
Result: The **Off Timer** menu is displayed.
- 10 Select the **Hour**, **Min.** or **Activation** by pressing the **◀** or **▶** button.
Set these by pressing the **▼** or **▲** button.

➤ When pressing the "I" button (On/Off) on the side of the television, the clock setting will be reset.

➤ Absent Power Off

When you set the timer "On", your television will eventually be turned off, if you do not operate any controls during the 3 hours after the TV is turned on by timer. This function is available in only the timer "On" mode and will prevent a leakage accident or overheating, caused by your TV left on for a long time due to the timer "On" (when you are away on holiday, for example).

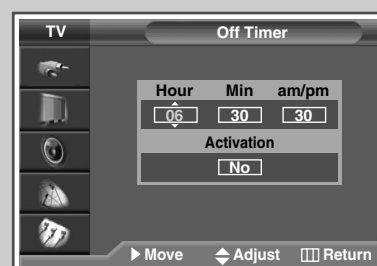

Viewing an External Signal Source

ENG

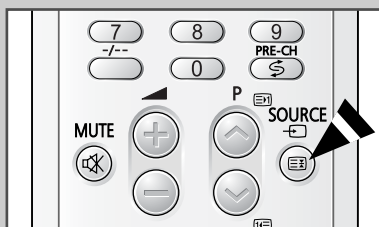
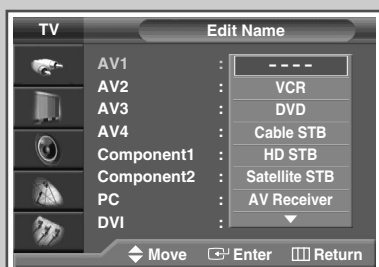
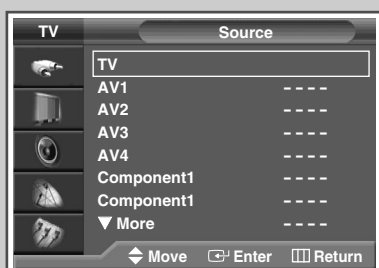



Use the remote control to switch between viewing signal from connected equipment, such as VCR, DVD, Set-Top-boxes and the TV source (broadcast or cable)



- 1 Press the **MENU** () button.
Result: The main menu is displayed.

- 2 Press the **▼** or **▲** button to select **Input** .
Result: The options available in the **Input** group are displayed.

- 3 Press the **ENTER** () button.

- 4 Press the **▼** or **▲** button to select **Source**.
Press the **ENTER** () button.
Result: The options available in the **Source** group are displayed.

- 5 Press the **▼** or **▲** button to select signal source, then press the **ENTER** () button.
➤ When you connect equipment to the TV, you can choose between the following sets of jacks : **AV1, AV2, AV3, Component1, Component2, PC** or **DVI** on the TV's rear panel, and **AV4** or **S-Video** on the TV's side panel.

- 6 Press the **MENU** () button and select **Input**.
Press the **ENTER** () button.

- 7 Press the **▼** or **▲** button to select **Edit Name** . Press the **ENTER** () button.
Result: The options available in the **Edit Name** group are displayed.

- 8 Press the **▼** or **▲** button to select external device :
AV1 - AV2 - AV3 - AV4 - Component1 - Component2 - PC - DVI.

- 9 Press the **ENTER** () button.
Result: The **Edit Name** available are listed.

- 10 Select the name by pressing the **▼** or **▲** button.
Press the **ENTER** () button.

- 11 Set other signal sources (**AV1, AV2, AV3, AV4, Component1, Component2, PC** or **DVI**) using the same method as listed above.

➤ You can also set these options simply by pressing the **SOURCE** () button. If you change the external source while viewing, pictures might take a short period of time to be switched.

Viewing the Picture In Picture (PIP)

ENG

You can display a sub picture within the main picture of TV program or external A/V devices. In this way you can watch TV program or monitor the video input from any connected devices while watching TV or other video input.

- 1 Press the **MENU** () button.
Result: The main menu is displayed.

- 2 Press the **▼** or **▲** button to select **Picture**.
Result: The options available in the **Picture** group are displayed.





- 3 Press the **▼** or **▲** button to select **PIP**. Press the **ENTER** () button.
Result: The options available in the **PIP** group are displayed.

- 4 To activate, set the **PIP** to **on** by pressing the **▼** or **▲** button.

- 5 Press the **ENTER** () button.

- 6 Press the **▼** or **▲** button to select **Source**. Select a source of the sub picture by pressing the **ENTER** () button.
Result: The sources are displayed in the following order:
TV - AV1 - AV2 - AV3 - AV4 - Component1 - Component2 - PC - DVI

- 7 Press the **▼** or **▲** button to select **Swap**. Press the **ENTER** () button.
Result: The main picture and sub picture are interchanged.

- 8 Press the **▼** or **▲** button to select **Size**. Select a size of the sub picture by pressing the **ENTER** () button.
Result: The sizes are displayed in the following order:
   
(Large) – (Small) – (Double1) – (Double2)

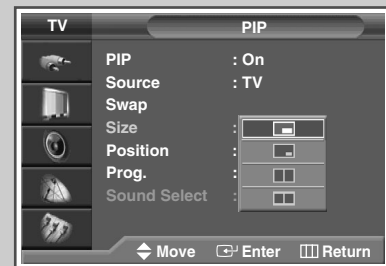
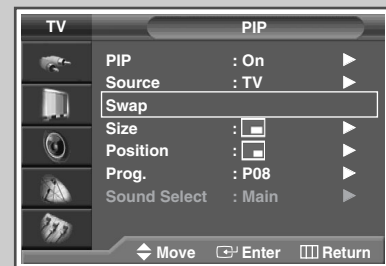
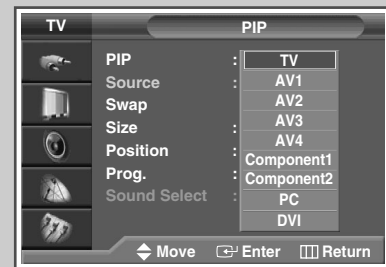
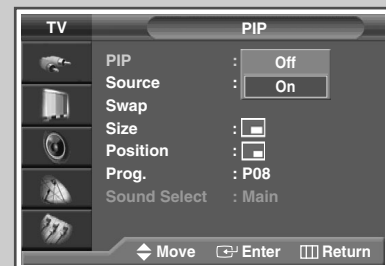
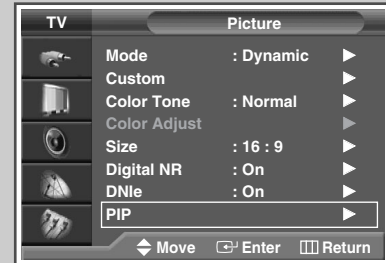

Viewing the Picture In Picture (PIP) (continued)

ENG

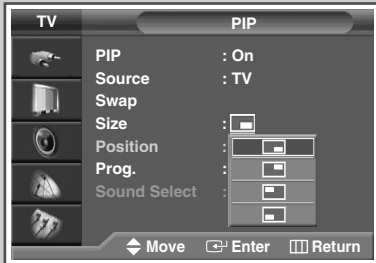

PC or DVI Mode

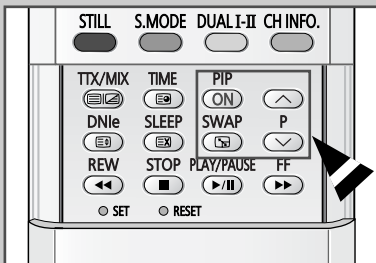
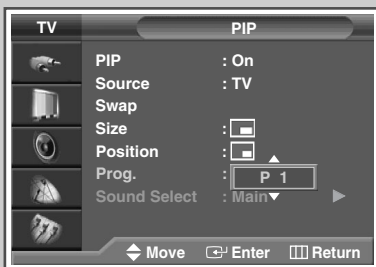
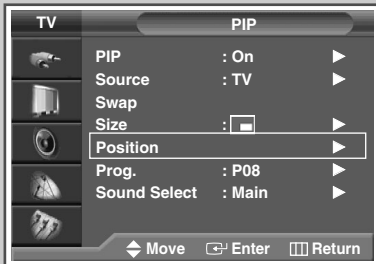

- 9 Press the **▼** or **▲** button to select **Position**. Press the **ENTER** (**↵**) button.

Result: The positions available are displayed.

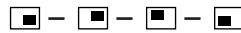

- 10 Press the **▼** or **▲** button to select **Prog.**. Select the channel that you want to view through sub picture by pressing the **ENTER** (**↵**) button.

➤ If the sub picture is no signal and the main picture is output from a Component, PC or DVI signal, the sub picture will be blue. If the main picture is output from a Video signal, the sub picture will be black.

Easy functions of remote control.

Buttons	Feature
PIP ON	Used to activate or deactivate the PIP function directly.
SWAP	Used to interchange the main picture and the sub picture.





➤ When the main picture is in the Video mode and the sub picture is in the TV mode, you might not hear the sound of main picture when pressing the **SWAP** (**↔**) button after changing the sub picture channel. At this time, reselect the channel of main picture.

P ▲ / ▼ Used to select the channel of sub picture.

Listening to the Sound of the Sub Picture (PC or DVI Mode)

➤ Preset to the **PC** or **DVI** mode by using the **SOURCE** button.

During the PIP feature is activating, you can listen to the sound of the sub picture.

- 1 Press the **MENU** () button.
Result: The main menu is displayed.
 - 2 Press the **▼** or **▲** button to select **Picture**.
Result: The options available in the **Picture** group are displayed.
 - 3 Press the **▼** or **▲** button to select **PIP**. Press the **ENTER** () button.
Result: The options available in the **PIP** group are displayed.
 - 4 To activate, set the **PIP** to **on** by pressing the **▼** or **▲** button.
 - 5 Press the **ENTER** () button.
 - 6 Press the **▼** or **▲** button to select **Sound Select**. Press the **ENTER** () button.
 - 7 Set to **Sub** by pressing the **▼** or **▲** button.
Result: You can listen to the sound of the sub picture.
- To listen the sound of current main picture, set to **Main**.

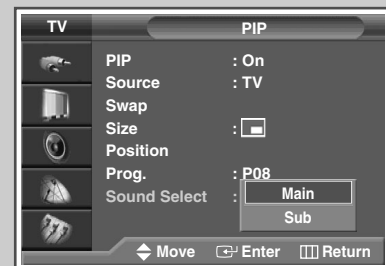
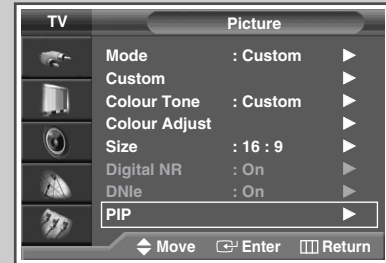

ENG

Teletext Feature

ENG

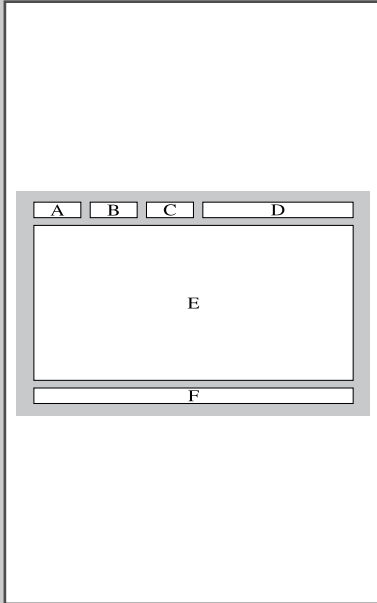

Most television channels provide written information services via teletext. Information provided includes:

- ◆ *Television programme times*
- ◆ *News bulletins and weather forecasts*
- ◆ *Sports results*
- ◆ *Travel information*

This information is divided into numbered pages (see diagram).

Part	Contents
A	Selected page number.
B	Broadcasting channel identity.
C	Current page number or search indications.
D	Date and time.
E	Text.
F	Status information. FASTEXT information.

- Teletext information is often divided between several pages displayed in sequence, which can be accessed by:
- ◆ Entering the page number
 - ◆ Selecting a title in a list
 - ◆ Selecting a coloured heading (FASTEXT system)

Displaying the Teletext Information

ENG

You can display Teletext information at any time on your television

- ☞ For Teletext information to be displayed correctly, channel reception must be stable; otherwise:
 - ◆ Information may be missing
 - ◆ Some pages may not be displayed

- 1 Select the channel providing the Teletext service by pressing the **P** or **P** button.
- 2 Press the **TTX/MIX** (📺) button to activate the teletext mode.
Result: The contents page is displayed. It can be redisplayed at any time by pressing the (📺) (index) button.
- 3 Press the **TTX/MIX** (📺) button again.
Result: The screen will be split into two. This Double Teletext feature lets you view the actual broadcast and teletext information separately on the screen.
- 4 If you wish to display the teletext information on a single screen, press the **TTX/MIX** (📺) button again.
- 5 To exit from the teletext display, press the **TV** (📺) button.

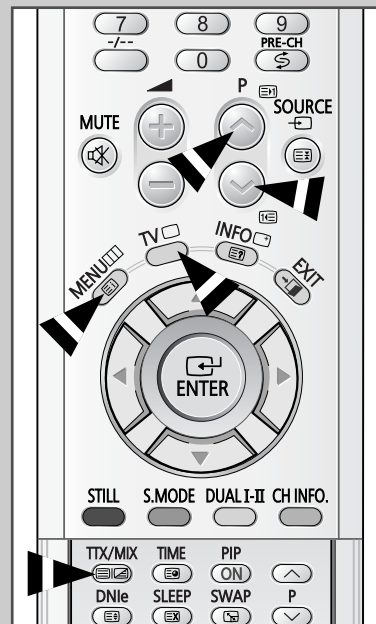

Selecting Display Options

ENG

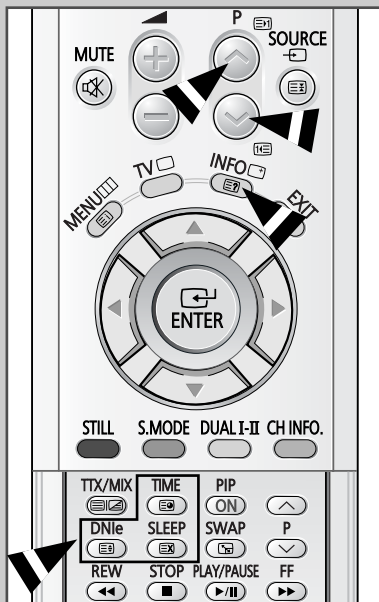

When you have displayed a Teletext page, you can select various options to suit your requirements.

To display...	Press the...
◆ Hidden text (answers to quiz games, for example)	[REVEAL] (reveal)
◆ The normal screen	[REVEAL] (reveal) again
◆ A secondary page by entering its number	[SUB-PAGE] (sub-page)
◆ The broadcast when searching for a page	[CANCEL] (cancel)
◆ The next page	[PAGE UP] (page up)
◆ The previous page	[PAGE DOWN] (page down)
◆ Double-size letters in the: <ul style="list-style-type: none"> • Upper half of the screen • Lower half of the screen 	[SIZE] (size) <ul style="list-style-type: none"> • Once • Twice
◆ The normal screen	[REVEAL] (size) <ul style="list-style-type: none"> • Three times



Selecting a Teletext Page

You can enter the page number directly by pressing the numeric buttons on the remote control.

- 1 Enter the three-digit page number given in the content by pressing the corresponding numeric buttons.

Result: The current page counter is incremented and the page is then displayed. If the selected page is linked with several secondary pages, the secondary pages are displayed in sequence. To freeze the display on a given page, press the  (hold) button. Press the it again to resume.
- 2 If the FASTEXT system is used by the broadcasting company, the different topics covered on a Teletext page are colour-coded and can be selected by pressing the coloured buttons on the remote control. Press the coloured button corresponding to the topic that you wish to select; the available topics are given on the status line.

Result: The page is displayed with other coloured information that can be selected in the same way.
- 3 To display the previous or next page, press the corresponding coloured button.
- 4 To display the subpage, see the following steps.
 - ◆ Press the  (sub-page) button.

Result: The available subpages appear.
 - ◆ Select the required sub-page. Sub-pages can be scrolled by pressing the  or  button.

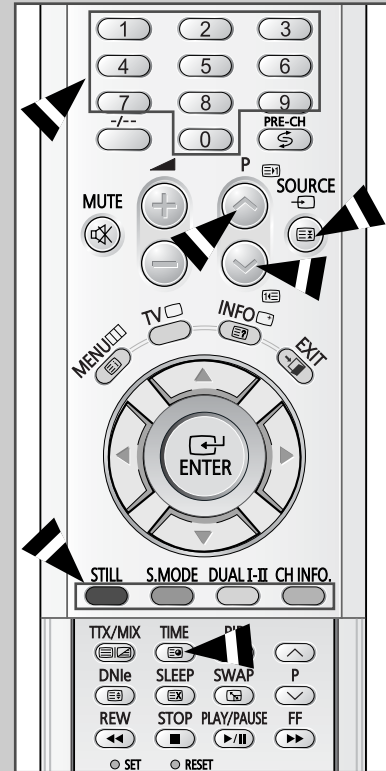

ENG

Connecting to the External Input/Output

ENG

“AV3” is used for the equipment with an RGB output, such as video game devices or video disc players.

Rear of the TV

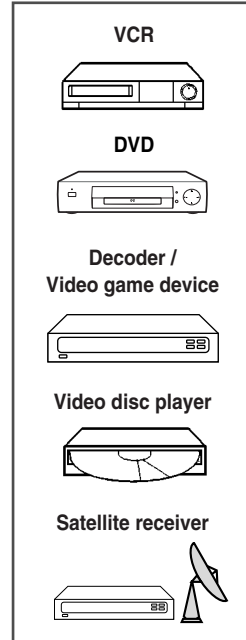
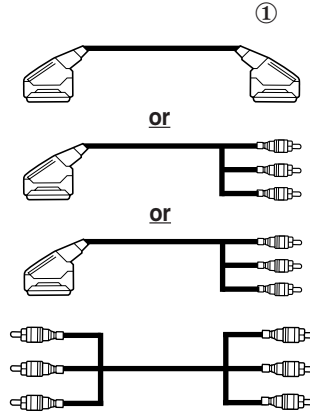
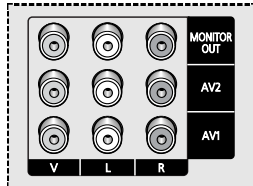
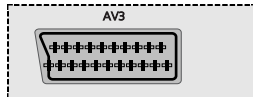

- ① This end can be fitted with:
- ◆ A SCART connector
 - ◆ An S-Video connector and two audio RCA connectors (L+R)
 - ◆ Three RCA connectors (VIDEO + AUDIO-L/R)

Input/Output Specification

Connector	Input				Output
	Video	Audio (L/R)	S-Video	RGB	Video + Audio (L/R)
AV1	✓	✓	✓		
AV2	✓	✓	✓		
AV3	✓	✓	✓	✓	Only TV output is available.
MONITOR OUT					Output you are viewing.



Whenever you connect an audio or video system to your television, ensure that all elements are switched off.

Refer to the documentation supplied with your equipment for detailed connection instructions and associated safety precautions.

Connecting to the DVD Input

ENG

The RCA connectors are used for equipment with a DVD output.

Rear of the TV

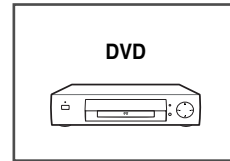
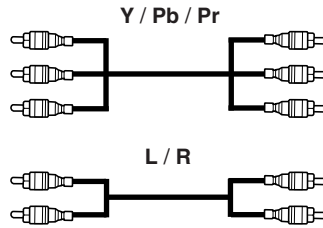
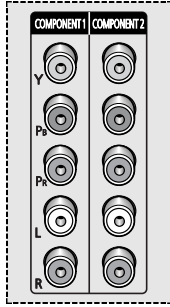

Connecting to the Audio Outputs

The "AUDIO OUT" connectors are used for equipment, such as an audio system or external amplifier (to take full advantage of the Surround sound effect).

Rear of the TV

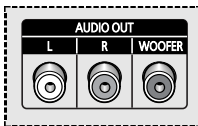

Audio System/ External Amplifier



Connecting to the Audio/Video Input

The RCA (VIDEO + L-AUDIO-R) connectors are used for equipment such as camcorders, video disc players and some video game devices.

Side of the TV

**SP46L5HX/
SP56L5HX**



**SP43L2HX/
SP50L2HX/
SP61L2HX**

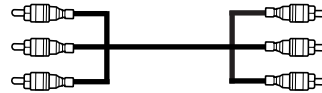
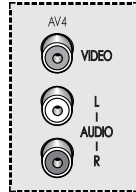

Camcorder

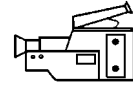

Video disc player

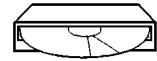

Video game device

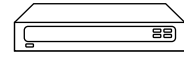

Connecting to the S-Video Input

The S-VIDEO and RCA (AUDIO-L/R) connectors are used for equipment with an S-Video output, such as a camcorder or VCR.

Rear of the TV

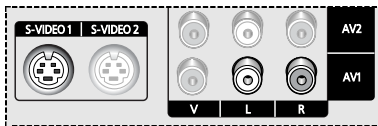

or

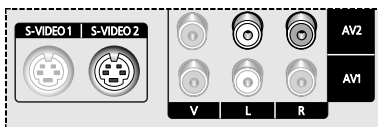

Side of the TV

**SP46L5HX/
SP56L5HX**

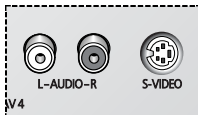

**SP43L2HX/SP50L2HX/
SP61L2HX**

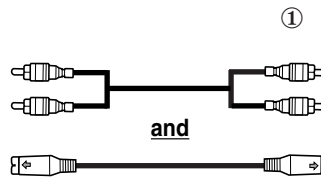
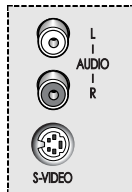

Camcorder

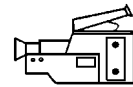

VCR

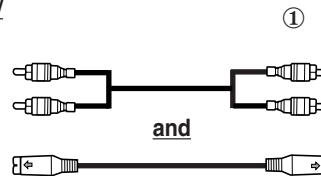
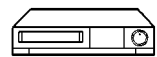

① To play picture and sound, both the S-VIDEO and RCA connectors must be used.

Connecting to the DVI Input

The “DVI” (video) and “PC AUDIO (L+R)” connectors are used for equipment with a DVI output.

Rear of the TV

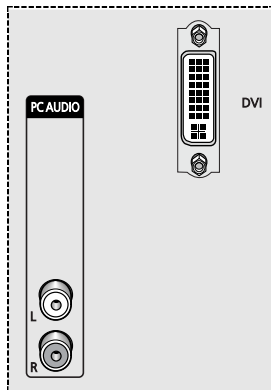

and



Personal Computer



- The “DVI” does not support the Analog R (red), G (green) and B (blue) signals.

Connecting to the PC Input

The “PC” (video) and “PC AUDIO (L+R)” connectors are used for interfacing with your PC.

Rear of the TV

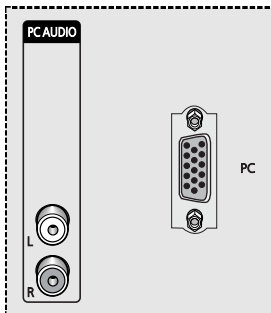

and

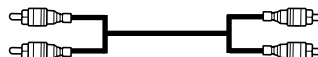

Personal Computer



Setting up Your PC Software (Windows only)

ENG

The Windows display-settings for a typical computer are shown below. But the actual screens on your PC will probably be different, depending upon your particular version of Windows and your particular video card. But even if your actual screens look different, the same, basic set-up information will apply in almost all cases. (If not, contact your computer manufacturer or Samsung Dealer.)



On the windows screen, select in the following sequence: **Start → Settings → Control Panel.**

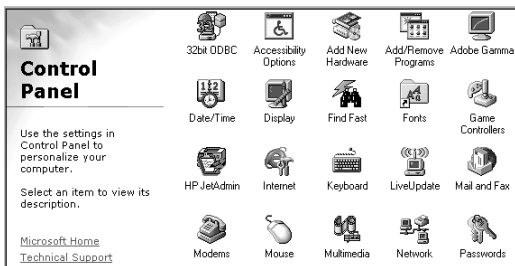

When the control panel screen appears, click on **Display** and a display dialog-box will appear.

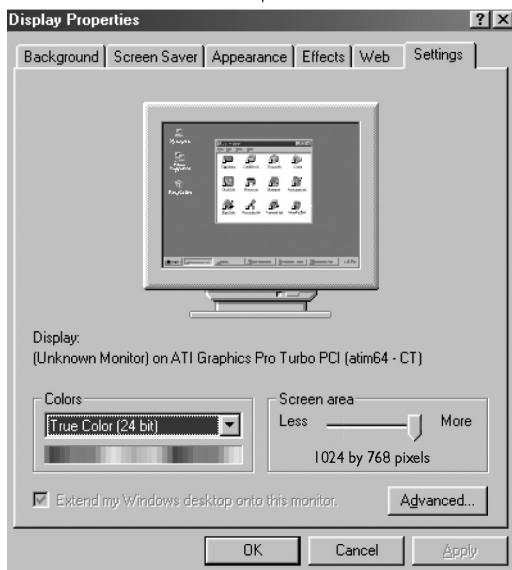

Select the **Settings** tab in the display dialog-box.

The two key variables that apply the television-PC interface are "Resolution" and "Colours". The correct settings for these two variables are:

- ◆ Size (sometimes called "Resolution")
1024 x 768 pixels.
- ◆ Colour
24-bit colour (might also be expressed as "16 million colours")
Shown at left is a typical screen for "Display" dialog box.

If a vertical-frequency option exists on your display settings dialog box, the correct value is **60 Hz**. Otherwise, just click **OK** and exit the dialog box.

Input Mode (PC/DVI)

ENG

Both screen position and size will vary depending on the type of PC monitor and its resolution. The table below shows all of the display modes that are supported:

Standard	Dot x Line	Vertical frequency (Hz)	Horizontal frequency (kHz)	Vertical polarity	Horizontal polarity
VGA	640 x 480	75.0	37.5	N	N
		72.8	37.9	N	N
		59.9	31.5	N	N
	720 x 400	70.1	31.5	P	N
SVGA	800 x 600	75.0	46.9	P	P
		72.2	48.1	P	P
		60.3	37.9	P	P
		56.3	35.2	P	P
XGA	1024 x 768	75.0	60.0	P	P
		70.1	56.5	N	N
		60.0	48.3	N	N
WVGA	848 x 480	75	37.5	N	P
		72	36.1	N	P
		70	35.0	N	P
		60	29.8	N	P

(N: Negative / P: Positive)

- ◆ The interlace mode is not supported.
- ◆ The television might operate abnormally if a non-standard video format is selected.
- ◆ The 4:3 mode does not work with input signals from "720 x 400".
- ◆ The DVI mode does not support "1024 x 768" (85Hz).

Notes

- ◆ **The text quality of PC screen is optimum in the XGA mode (1024 x 768), the full size displayed PC mode is optimum in the SVGA mode (800 x 600).**
- ◆ When this television is used as a PC display, 24-bit colour is supported (over 16 million colours).
- ◆ Your PC display screen might appear different depending on the manufacturer (and your particular version of Windows). Check your PC instruction book for information about connecting your PC to a television.
- ◆ If a vertical and horizontal frequency-select mode exists, select 60Hz (vertical) and 31.5kHz (horizontal). In some cases, abnormal signals (such as stripes) might appear on the screen when the PC power is turned off (or if the PC is disconnected). If so, press the **SOURCE** () button to enter the Video mode. Also, make sure that the PC is connected.
- ◆ When connecting a notebook PC to the television, make sure that the PC screen is displayed through only the television (Otherwise, random signals might appear).
- ◆ When horizontal synchronous signals seem irregular in PC mode, check PC power saving mode or cable connections.

Pin Configurations

ENG

SCART Connector (AV1/AV2/AV3)

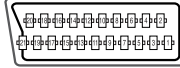

Pin	Signal
1	Audio output R
2	Audio input R
3	Audio output L
4	Audio chassis return
5	Video chassis return (RGB blue)
6	Audio input L
7	RGB blue input
8	Switching voltage
9	Video chassis return (RGB green)
10	-
11	RGB green input
12	-
13	Video chassis return (RGB red)
14	-
15	RGB red input
16	Blanking signal (RGB switching)
17	Video chassis return
18	Blanking signal ground
19	Video output
20	Video input
21	Screening/chassis return

➤ Pins 5, 7, 9, 11, 13, 15 and 16 are used for RGB processing and are only wired on the **AV1** or **AV3** connector.

DVI Input Connector (24Pin)

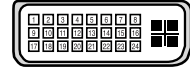

Pin	Signal
1	T.M.D.S. Data2-
2	T.M.D.S. Data2+
3	T.M.D.S. Data2/4 Shield
4	T.M.D.S. Data4-
5	T.M.D.S. Data4+
6	Clock (DDC)
7	Data (DDC)
8	Not Connected
9	T.M.D.S. Data1-
10	T.M.D.S. Data1+
11	T.M.D.S. Data1/3 Shield
12	T.M.D.S. Data3-
13	T.M.D.S. Data3+
14	+5V Power
15	5V Grounding
16	Hot Plug Detect
17	T.M.D.S. Data0-
18	T.M.D.S. Data0+
19	T.M.D.S. Data0/5 Shield
20	T.M.D.S. Data5-
21	T.M.D.S. Data5+
22	T.M.D.S. Clock Shield
23	T.M.D.S. Clock+
24	T.M.D.S. Clock-

PC Input Connector (15Pin)

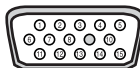

Pin	PC IN
1	Red (R)
2	Green (G)
3	Blue (B)
4	Grounding
5	Grounding (DDC)
6	Red (R) Grounding
7	Green (G) Grounding
8	Blue (B) Grounding
9	Reserved
10	Sync Grounding
11	Grounding
12	Data (DDC)
13	Horizontal sync.
14	Vertical sync.
15	Clock (DDC)

RS-232 Connector (9Pin)

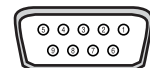

Pin	Signal
1	Carrier Detect
2	Receive Data
3	Transmit Data
4	Data Terminal Ready
5	System Ground
6	Data Set Ready
7	Request to Send
8	Clear to Send
9	Ring Indicator

Programming the Remote Control for Other Components

ENG

This TV's remote control can operate VCR, CATV, DVD, or Set-top box (STB), in addition to controlling the TV.

- The remote control might not be compatible with the TV manufactured by another company.

- 1 Turn off your VCR, Cable box, DVD or STB.
- 2 Press the **SELECT** button. Mode is changed whenever **SELECT** button is pressed. (new mode is displayed on LED screen.)
- 3 Press the **SET** button.
- 4 Use the numeric buttons to enter the code by manufacturer. Each code must be three digits long.
Example: To enter the code "6", press 0, 0, and 6.
To enter the code "76", press 0, 7, and 6.
 - See the remote control code tables to find the appropriate code for your particular component. If more than one code is listed, try each one separately until you find the one that works.
- 5 Press the **POWER** (⏻) button on the remote control. The component you select should turn on. If it turns on, your remote control is now set correctly.
 - If it does not turn on, repeat steps above, but try one of the other codes listed for the brand of particular yours.
- 6 Once your remote control is set up, press the **SELECT** button any time you want to use the remote control to operate your VCR, Cable box, DVD or STB.
 - ◆ When your remote control is in the **VCR, CATV, DVD** or **STB** mode, the volume buttons still control your television's volume.
 - ◆ When your remote control is in the **TV** or **CATV** mode, the VCR or DVD control buttons (PLAY, PAUSE, etc.) still operate your VCR or DVD.

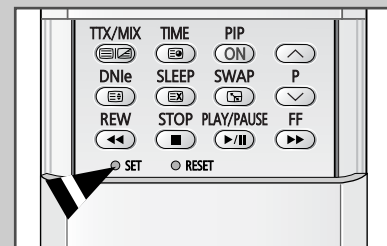
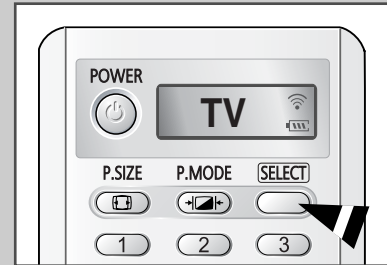

Programming the Remote Control for Other Components

ENG

VCR Remote Control Codes

Admiral	020	Marantz	007, 008, 018, 021, 026, 036, 037, 062
Aiwa	025	Marta	006
Akai	004, 027, 032	MEI	021
Audio Dynamics	007, 026	Memorex	006, 021, 024, 025
Bell&Howell	018	MGA	034
Broksonic	022	Midland	005
Candle	002, 003, 006, 008, 015, 055	Minolta	019, 041
Canon	021, 056	Mitsubishi	019, 034, 041, 046
Citizen	002, 003, 006, 008, 015, 055	Montgomery Ward	020
Colortyme	007	MTC	002, 025
Craig	002, 024	Multitech	002, 005, 025, 038
Curtis Mathes	002, 007, 008, 017, 021, 025, 056, 064, 066	NEC	007, 008, 018, 026, 037, 062, 064
		Optimus	020
Daewoo	003, 010, 011, 012, 013, 014, 015, 016	Panasonic	021, 056, 071, 072
DBX	007, 026	Pentax	019, 041
Dimensia	017	Pentex Research	008
Dynatech	034	Philco	021, 036, 056, 059
Emerson	001, 003, 006, 021, 022, 025, 030, 032, 034, 040, 047, 050, 052, 060, 063, 065, 066, 067, 069	Philips	021, 036
		Pioneer	019, 026, 039, 053
		Portland	015, 049, 055
Fisher	018, 024, 028, 029, 048, 051, 061	PROSCAN	017
Funai	025	Quartz	018
General Electric	002, 005, 017, 021, 056	Quasar	021, 056
Go Video	002	Radio Shack/Realistic	006, 018, 020, 021, 024, 025, 029, 034, 048, 056
LG (Goldstar)	006, 007, 008, 009, 010		
Harman Kardon	007	RCA	002, 017, 019, 021, 035, 041, 043, 057, 068
Hitachi	019, 025, 041, 042		
Instant Replay	021	Samsung	000, 001, 002, 003, 004, 005
JC Penney	002, 007, 018, 019, 021, 026, 037, 041, 054, 056	Sansui	026
		Sanyo	018, 024
JVC	007, 008, 018, 021, 026, 037	Scott	003, 047, 052, 067
Kenwood	007, 008, 018, 026, 037	Sears	006, 018, 019, 024, 028, 029, 041, 048, 051
KLH	070		
Lloyd	025	Sharp	020, 034, 045, 015
Logik	038	Shimom	027, 033, 038, 058
LXI	025	Signature	025
Magnavox	021, 036, 056, 059	Sony	027, 033, 044

Programming the Remote Control for Other Components

ENG

VCR Remote Control Codes (continued)

Sylvania	021, 025, 036, 056, 059	Totevision	002, 006
Symphonic	025	Unitech	002
Tandy	018, 025	Vector Research	007, 026
Tashika	006	Victor	026
Tatung	037	Video Concepts	007, 026
Teac	025, 037, 068	Videosonic	002
Technics	021	Wards	002, 003, 006, 019, 020, 021, 024, 025,
Teknika	006, 021, 025, 031		034, 038, 041
TMK	066	Yamaha	007, 008, 018, 026, 037
Toshiba	003, 019, 029, 051, 052	Zenith	023, 027, 033, 073

Cable Box (CATV) Remote Control Codes

Anvision	017, 018	Regency	015, 023
GI	041	SA	042, 043
Hamlin	003, 024, 031	Samsung	000, 001, 002, 003, 004, 005, 006, 007
Hitachi	025, 030	Scientific Atlanta	042, 043
Jerrold	038, 039	Sprucer	022
Macom	025, 030	Stargate 2000	036
Magnavox	019, 023, 028	Sylvania	016
Oak	026	Texscan	016
Panasonic	003, 022, 027, 037, 044	Tocom	032
Philips	019, 021, 023, 028	Universal	033, 034
Pioneer	004, 018, 020, 044	Viewstar	019, 021, 023, 028
RCA	014, 022, 040	Wamer amex	046
Regal	003	Zenith	017, 029, 035, 037, 045

DVD Remote Control Codes

Samsung	000, 001	LG (Goldstar)	006
JVC	002	Sony	007
PROSCAN/RCA	003	Denon	008
Panasonic	005	Curtis Mathes	009

Troubleshooting: Before Contacting Service Personnel

ENG

Before contacting Samsung after-sales service, perform the following simple checks.

If you cannot solve the problem using the instructions below, note the model and serial number of the television and contact your local dealer.

No sound or picture	<ul style="list-style-type: none">◆ Check that the mains lead has been connected to a wall socket.◆ Check that you have pressed the "I" button (On/Off) and the POWER (⏻) button.◆ Check the picture contrast and brightness settings.◆ Check the volume.
Normal picture but no sound	<ul style="list-style-type: none">◆ Check the volume.◆ Check whether the volume MUTE (🔇) button on the remote control has been pressed.
No picture or black and white picture	<ul style="list-style-type: none">◆ Adjust the colour settings.◆ Check that the broadcast system selected is correct.
Sound and picture interference	<ul style="list-style-type: none">◆ Try to identify the electrical appliance that is affecting the television, then move it further away.◆ Plug your television into a different mains socket.
Blurred or snowy picture, distorted sound	<ul style="list-style-type: none">◆ Check the direction, location and connections of your aerial. This interference often occurs due to the use of an indoor aerial.
Remote control malfunctions	<ul style="list-style-type: none">◆ Replace the remote control batteries.◆ Clean the upper edge of the remote control (transmission window).◆ Check the battery terminals.

Technical Specifications

ENG

The descriptions and characteristics in this booklet are given for information purposes only and are subject to modification without notice.

Model name	SP43L2HX	SP50L2HX	SP61L2HX	SP46L5HX	SP56L5HX
Tube type	16:9	16:9	16:9	16:9	16:9
Screen size	43 inch (953/535.5 mm)	50 inch (1107/623 mm)	61 inch (1351/760 mm)	46 inch (1018/573 mm)	56 inch (1240/697 mm)
Color systems	PAL, SECAM, NTSC4.43, NTSC3.58				
TV standards	BG, DK, I, M				
Sound	A2 Stereo, NICAM Stereo, Dolby Prologic				
Audio output power	15 W x 4				
Sockets	Rear	External input/outputs (RCA (AV1 / AV2), Scart (AV3), MONITOR OUT) Surround speaker outputs (+ R - / - L +) Audio outputs (L / R / WOOFER) S-Video inputs (S-VIDEO 1 / S-VIDEO 2) Component inputs (Component1, Component2 (Y / PB / PR / L / R)) PC audio inputs (PC AUDIO - L / R) PC video input (PC - 15Pin) DVI video input (DVI - 24Pin) RS-232 input (RS-232 - 9Pin)			
	Side	Video/Audio inputs (VIDEO + L-AUDIO-R) S-Video Input (S-VIDEO)			
Dimensions (H x W x D mm)	1029 x 755 x 399	1184 x 859 x 444	1436 x 1021 x 489	1030 x 760 x 410	1268 x 924 x 461
Weight	27.6 kg	32.7 kg	44.5 kg	33.5 kg	41.5 kg
Accessories	Remote control, 2 Batteries (AAA), RCA cable, Owner's manual, Warranty card, Service network list				

Memo

ENG

Empty rectangular box for memo content.

Memo

ENG

Large empty rectangular box for writing the memo content.

– AFTER SALES SERVICE

- Do not hesitate to contact your retailer or service agent if a change in the performance of your product indicates that a faulty condition may be present.

