

The Samsung logo, consisting of the word "SAMSUNG" in white, bold, uppercase letters inside a black, horizontally-oriented oval.

PDP-TELEVISION

(PLASMA DISPLAY PANEL)

Owner's Instructions

Before operating the unit,
please read this manual thoroughly,
and retain it for future reference.

This device is a Class B digital apparatus.
Register your product at www.samsung.com/global/register

User Instructions

◆ Screen Image retention

Do not display a still image (such as on a video game or when hooking up a PC to this PDP) on the plasma monitor panel for more than 2 hours as it can cause screen image retention. This image retention is also known as "screen burn". To avoid such image retention, reduce the degree of brightness and contrast of the screen when displaying a still image.

◆ Height

The PDP can normally operate only under 2000m in height. It might abnormally function at a place over 2000m in height so do not install and operate there.

◆ Heat on the top of the PDP TV

The top side of the product may be hot after long periods of use as heat dissipates from the panel through the vent hole in the upper part of the product. This is normal and does not indicate any defect or operation failure of the product. However, children should be prevented from touching the upper part of the product.

◆ The product is making a 'cracking' noise.

A 'cracking' noise may occur when the product contracts or expands due to a change of surrounding environment such as temperature or humidity. This is normal and not a defect of the unit.

◆ Cell Defects

The PDP uses a panel consisting of 1,230,000(SD-level) to 3,150,000(HD-level) pixels which require sophisticated technology to produce. However, there may be few bright or dark pixels on the screen. These pixels will have no impact on the performance of the product.

◆ Avoid operating the TV at temperatures below 5°C(41°F)

◆ A still image displayed too long may cause permanent damage to the PDP Panel.



Watching the PDP TV in 4:3 format for a long period of time may leave traces of borders displayed on the left, right and centre of the screen caused by the difference of light emission on the screen.

Playing a DVD or a game console may cause similar effect to the screen. Damages caused by the above effect are not covered by the Warranty.

◆ Afterimage on the Screen.

Displaying still images from Video games and PC for longer than a certain period of time may produce partial afterimages. To prevent this effect, reduce the 'brightness' and 'contrast' when displaying still images.

◆ Warranty

- Warranty does not cover any damage caused by image retention.
- Burn-in is not covered by the warranty.

◆ Installation

Be sure to contact an authorized service centre, when installing your set in a location with heavy dust, high or low temperatures, high humidity, chemical substance and where it operates continually such as the airport, the train station etc. Failure to do so may cause a serious damage to your set.

Checking Parts

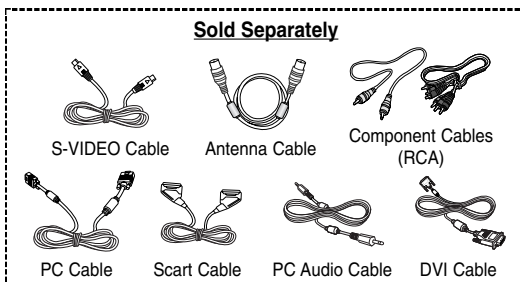
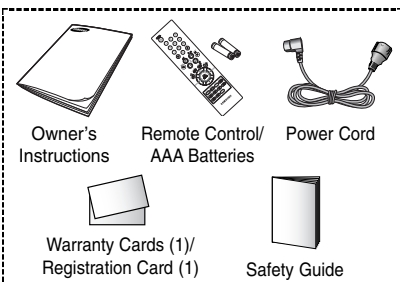

Contents

◆	GENERAL INFORMATION	
■	User Instructions	2
■	Checking Parts	2
■	Using the Stand-Base	4
■	Control Panel (depending on the model)	4
■	Connection Panel (depending on the model)	5
■	Viewing the Remote Control (depending on the model)	6
■	Installing Batteries in the Remote Control	6
◆	OPERATION	
■	Switching Your Television On and Off	7
■	Viewing the Menus	7
■	Freezing the Current Picture	7
■	Plug & Play Feature	8
■	Viewing an External Signal Source	9
■	Editing Device Names	9
◆	CHANNEL CONTROL	
■	Storing Channels Automatically	9
■	Storing Channels Manually	10
■	Skipping Unwanted Channels	11
■	Sorting the Stored Channels	11
■	Assigning Names to Channels	11
◆	PICTURE CONTROL	
■	Changing the Picture Standard	12
■	Customizing the Picture Settings	12
■	Selecting the Picture Size	13
■	Digital NR	13
■	Dynamic Contrast	13
■	Viewing the Picture in Picture (PIP) (Available in PC mode)	14
◆	SOUND CONTROL	
■	Sound Features	15
◆	FUNCTION DESCRIPTION	
■	Time Features	16
■	Language	17
■	Blue Screen	17
■	Melody	17
■	Energy Saving	17
■	Screen Burn Protection	18
◆	PC DISPLAY	
■	Setting up Your PC Software (Windows only)	19
■	Input Mode (PC)	19
■	Setting the PC	20
■	Teletext Feature (depending on the model)	21
◆	APPENDIX	
■	Installing the Display on the Wall Attachment Panel	22
■	Troubleshooting	23

Symbols



Press



Important



Note

Using the Stand-Base

- Two or more people should carry the PDP. Never lay the PDP on the floor because of possible damage to the screen. Always store the PDP upright.
- Pull the folded stand in the direction of the arrow.

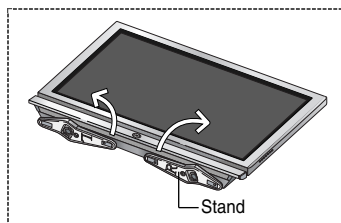

Control Panel (depending on the model)

- The actual configuration of your TV may be different, depending on your model.

Front (or Side) Panel

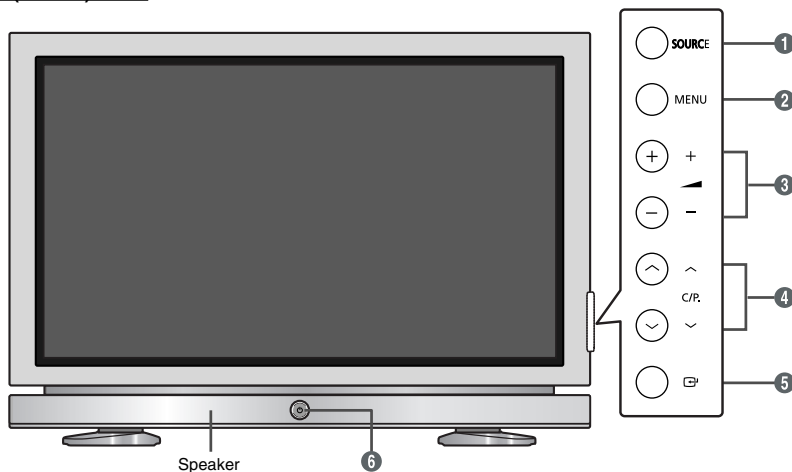

- 1 SOURCE**
Displays a menu of all of the available input sources (TV, Ext.1, Ext.2, AV, S-Video, Component, PC, DVI).
- 2 MENU**
Press to see the on-screen menu of your TV's features.
- 3 -▲ +**
Press to decrease or increase the volume. In the on-screen menu, use the -▲ + buttons as you use the ◀ and ▶ buttons on the remote control.
- 4 ▼ C/P. ▲**
Press to change channels. In the on-screen menu, use the ▼ C/P. ▲ buttons as you use the ▲ and ▼ buttons on the remote control.
- 5 [ENTER]**
Press to confirm a selection.
- 6 [Power] button**
Press to turn the TV on and off.

Power Indicator

- Power Off: Red
- Power On: Off

Remote Control Sensor

Aim the remote control towards this spot on the TV.

Connection Panel (depending on the model)

➤ The actual configuration of your TV may be different, depending on your model.

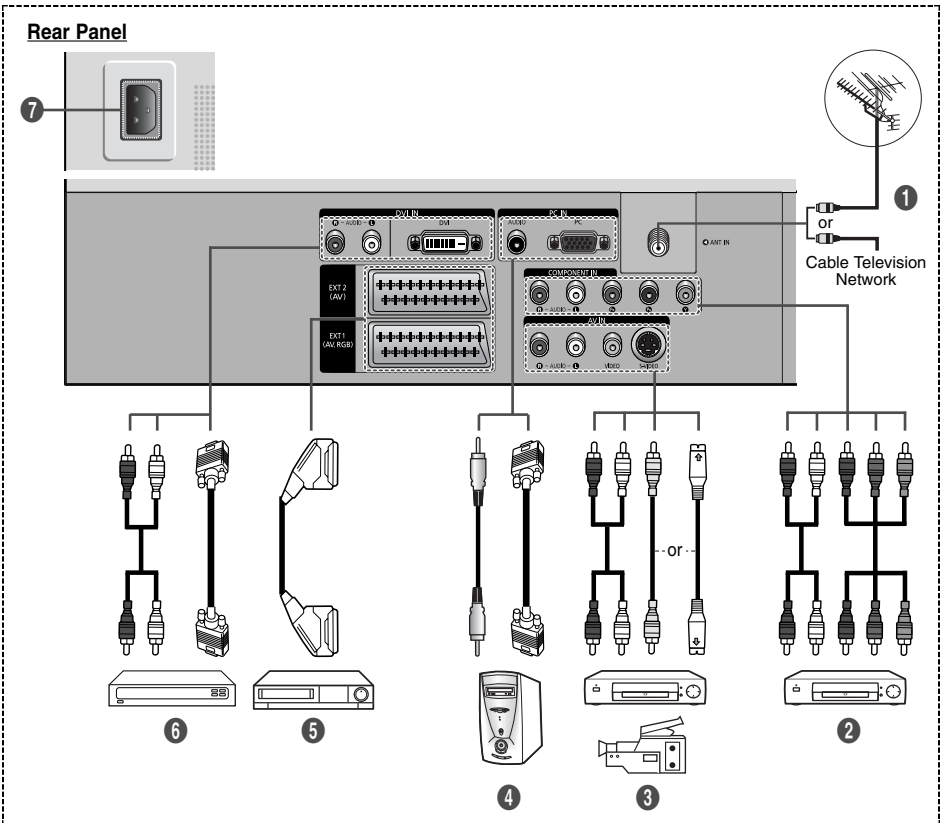

- ☛ Whenever you connect an audio or video system to your set, ensure that all elements are switched off.
- ☛ When connecting an external device, match the colour of the connection terminal to the cable.

1 Connecting an Aerial or Cable Television Network

2 Connecting Component Devices (DTV/DVD)

- Connect component video cables to component connector ("PR", "PB", "Y") on the rear of your set and the other ends to corresponding component video out connectors on the DTV or DVD.
- This PDP displays the optimum picture in 720p mode.

3 Connecting External A/V Devices

- Connect RCA or S-VIDEO cable to an appropriate external A/V device such as VCR, DVD or Camcorder.
- Connect RCA audio cables to "R - AUDIO - L" on the rear of your set and the other ends to corresponding audio out connectors on the A/V device.

4 Connecting Computer

- Connect the D-Sub cable to "PC (PC IN)" on the rear of your set and the other end to the Video card of your computer.

5 Connecting Set-Top Box, VCR or DVD

- Connect the VCR or DVD SCART cable to the SCART connector of the VCR or DVD.

6 Connecting DVI

- Connect the DVI AUDIO (L, R) input jacks on the TV with the AUDIO output jacks on the Set-Top Box or DVD using an audio cable.
- The DVI IN jack is not compatible with PC.
- This PDP displays the optimum picture in 720p mode.

7 POWER IN

- Connect the supplied power cord.

Viewing the Remote Control (depending on the model)

➤ Operation of remote control may be affected by bright artificial light near to the TV.

- 1 Television Standby button
- 2 Number buttons for direct channel access
- 3 One/Two-digit channel selection
- 4 \oplus Volume increase
 \ominus Volume decrease
- 5 Temporary sound switch-off
- 6 Displays the main on-screen menu
- 7 Sound effect selection
- 8 Sound mode selection
- 9 Press to automatically store selected TV/cable channels
- 10 Use to store and delete channels to/from memory
- 11 Picture freeze
- 12 Selects the TV mode directly
- 13 Previous channel
- 14 Next channel
15 Previous channel
- 16 Available source selection
- 17 Use to see information on the current broadcast
- 18 Exit the on-screen menu
- 19 Control the cursor in the menu
- 20 Picture size selection
- 21 Picture effect selection
- 22 Picture-In-Picture On/Off
- 23 Automatic Power-off
- 24 Selects the PC mode directly

Teletext Functions (Refer to page 21)

- 1 Teletext hold
- 2 Teletext display/mix both teletext information and the normal broadcast
- 3 Teletext index
- 4 Teletext store
- 5 Teletext sub page
- 6 Exit from the teletext display
- 7 P \odot : Teletext next page
P \odot : Teletext previous page
- 8 Teletext mode selection (LIST/FLOF)
- 9 Teletext reveal
- 10 Teletext cancel
- 11 Teletext size selection
- 12 \odot \odot \odot \odot
Fastext topic selection

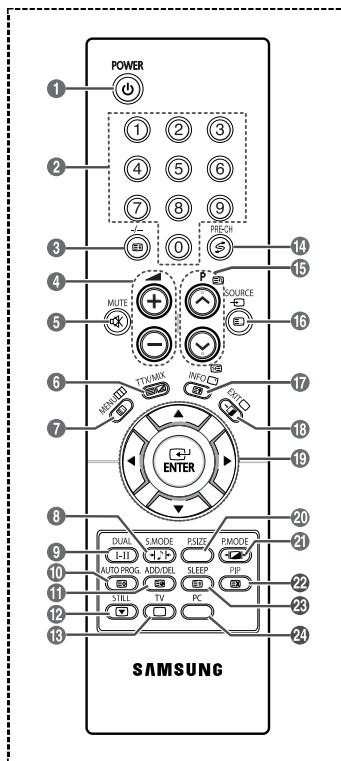

➤ The performance of the remote control may be affected by bright light.

Installing Batteries in the Remote Control

The mains lead is attached to the rear of the television.

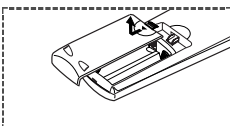

- 1 Slide the cover out completely.

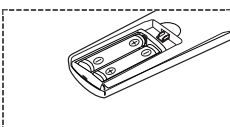

- 2 Install two AAA size batteries.

➤ Make sure to match the "+" and "-" ends of the batteries with the diagram inside the compartment.

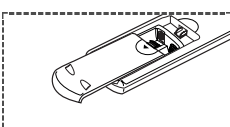

- 3 Replace the cover.



➤ Remove the batteries and store them in a cool, dry place if you won't be using the remote control for a long time. The remote control can be used up to about 23 feet from the TV. (Assuming typical TV usage, the batteries last for about one year.)

➤ **If the remote control doesn't work! Check the following:**











1. Is the TV power on?
2. Are the plus and minus ends of the batteries reversed?
3. Are the batteries drained?
4. Is there a power cut, or is the power cord unplugged?
5. Is there a special fluorescent light or a neon sign nearby?

Switching Your Television On and Off

The mains lead is attached to the rear of the television.

- 1 Plug the mains lead into an appropriate socket.
 - The main voltage is indicated on the rear of the television and the frequency is 50 or 60Hz.
- 2 Press the  (Power) button (On/Off) on the front of the television or press the **POWER** button on the remote control to switch the television on. The programme that you were watching last is re-selected automatically. If you have not yet stored any channels, no clear picture appears. Refer to "Storing Channels Automatically" on page 9 or "Storing Channels Manually" on page 10.
 - If the television is initially powered on, several basic customer settings proceed automatically. Refer to "Plug & Play Feature" on page 8.
- 3 To switch the television off, press the  (Power) button (On/Off) on the front of the television.

Viewing the Menus

- 1 Press the **MENU** () button.
The main menu is displayed on the screen.
Its left side has five icons: **Input**, **Picture**, **Sound**, **Channel**, and **Setup**.
- 2 Press the  or  button to select one of the icons.
Press the **ENTER** () button to access the icon's sub-menu.
- 3 Press the  or  button to move to items in the menu.
Press the **ENTER** () button to enter items in the menu.
- 4 Press the  or  button to change the selected items.
Press the **MENU** () button to return to the previous menu.
- 5 Press the **EXIT** button to exit from the menu.

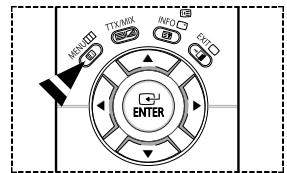
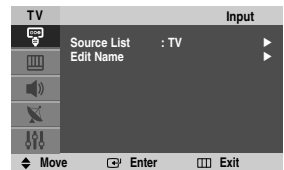

Freezing the Current Picture

You can freeze the picture when watching a television programme simply by pressing the "STILL" button. To return to normal viewing, press it again.

- This function will automatically cancel after 5 minutes.

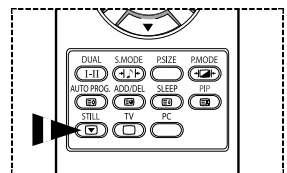

Plug & Play Feature

When the television is initially powered on, several basic customer settings proceed automatically and subsequently. The following settings are available.



- 1 If the television is in standby mode, press the **POWER** (⏻) button on the remote control. The message to start Plug & Play is displayed.
- 2 The **Language** menu will automatically appear after several seconds.
- 3 Select the appropriate language by pressing the **▲** or **▼** button. Press the **ENTER** (↵) button. The message to check the connected status of the antenna is displayed.
- 4 Make sure that the antenna is connected to the TV. Press the **ENTER** (↵) button. The **Country** menu is displayed.
- 5 Select your country or area by pressing the **▲** or **▼** button. Press the **ENTER** (↵) button. The menu to select channels is displayed.
- 6 To start channel store, press the **ENTER** (↵) button. The search will end automatically. The TV will begin memorizing all of the available channels. Press the **ENTER** (↵) button to set the clock.
- 7 Press the **◀** or **▶** button to select the hour or minute. Set these by pressing the **▲** or **▼** button.
 - You can enter the hours or minutes by using the numeric buttons on the remote control.
- 8 Press the **ENTER** (↵) button to confirm your setting. The message "**Enjoy your viewing**" is displayed.



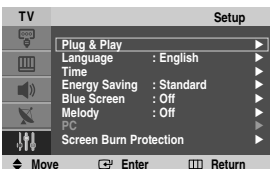

If you want to reset this feature ...

- 1 Press the **MENU** (⏻) button to display the menu.
- 2 Press the **▲** or **▼** button to select **Setup**, then press the **ENTER** (↵) button.
- 3 Press the **ENTER** (↵) button again to select **Plug & Play**. The message to start Plug & Play is displayed.



Viewing an External Signal Source

You can switch between viewing signal from connected equipment, such as a VCR, DVD, Set-Top Box, and the TV source (broadcast or cable).

- 1 Press the **MENU** () button to display the menu.
- 2 Press the **ENTER** () button to select **Source List**.
- 3 Press the **ENTER** () button again.
- 4 Press the **▲** or **▼** button to select the signal source, then press the **ENTER** () button.

Available signal source: **TV, Ext. 1, Ext. 2, AV, S-Video, Component, PC, DVI**



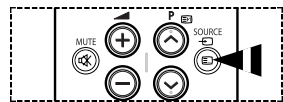
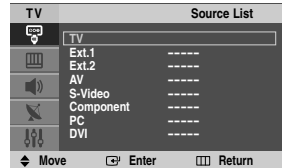
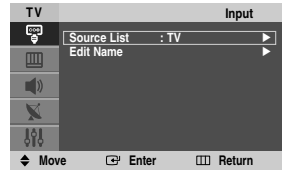

- 5 Press the **EXIT** button to exit.

➤ You can select these options simply by pressing the **SOURCE** button on the remote control.



Editing Device Names

You can give a name to the external source.

- 1 Press the **MENU** () button to display the menu.
- 2 Press the **ENTER** () button.
- 3 Press the **▲** or **▼** button to select the **Edit Name**, then press the **ENTER** () button.
- 4 Press the **▲** or **▼** button to select the external source to be edited, then press the **ENTER** () button.
- 5 Select the required device by pressing **▲** or **▼**, then press the **ENTER** () button.

Available device names: **VCR, DVD, Cable STB, HD STB, Satellite STB, AV Receiver, DVD Receiver, Game, Camcorder, DVD Combo, DHR (DVD HDD Recorder), or PC.**



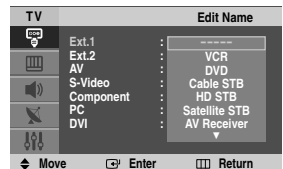





- 6 Press the **EXIT** button to exit.



Storing Channels Automatically

You can scan for the frequency ranges available to you (availability depends on your country).

Automatically allocated programme numbers may not correspond to actual or desired programme numbers. However you can sort numbers manually and clear any channels you do not wish to watch.

- 1 Press the **MENU** () button to display the menu.
- 2 Press the **▲** or **▼** button to select **Channel**, then press the **ENTER** () button.
- 3 Press the **ENTER** () button again. The available countries are listed.
- 4 Select your country by pressing the **▲** or **▼** button, then press the **ENTER** () button.
- 5 Press the **▲** or **▼** button to select **Auto Store**, then press the **ENTER** () button.
- 6 Press the **ENTER** () button again to start the search. The search will end automatically.
 - To stop the search before it has finished, press the **MENU** () or the **ENTER** () button.

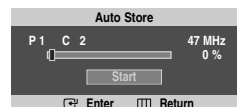

Storing Channels Manually

You can store television channels, including those received via cable networks.

When storing channels manually, you can choose:

- ◆ Whether or not to store each of the channels found.
- ◆ The programme number of each stored channel which you wish to identify.

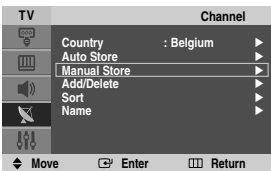

- 1 Press the **MENU** () button to display the menu.
- 2 Press the **▲** or **▼** button to select **Channel1**, then press the **ENTER** () button.
- 3 Press the **▲** or **▼** button to select **Manual Store**, then press the **ENTER** () button.
- 4 Select the required option by pressing the **▲** or **▼** button, then press the **ENTER** () button.
- 5 When you are satisfied with your setting, press the **ENTER** () button.
- 6 Press the **EXIT** button to exit.

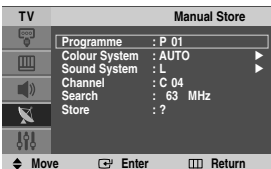

- ◆ **Programme** (Programme number to be assigned to a channel)
 - Press the **▲** or **▼** button until you find the correct number.
 - ◆ **Colour System: AUTO/PAL/SECAM/NTSC 4.43**
 - Press the **▲** or **▼** button to select the required colour standard.
 - ◆ **Sound System: BG/DK/I/L**
 - Press the **▲** or **▼** button to select the required sound standard.
 - ◆ **Channel** (When you know the number of the channel to be stored)
 - Press the **▲** or **▼** button to select **C** (Air channel) or **S** (Cable channel).
 - Press the **▶** button, then press the **▲** or **▼** button to select the required number.
 - You can also select the channel number directly by pressing the numeric buttons (0-9).
 - If there is abnormal sound or no sound, re-select the sound standard required.
 - ◆ **Search** (When you do not know the channel numbers)
 - Press the **▲** or **▼** button to start the search.
 - The tuner scans the frequency range until the first channel or the channel that you selected is received on the screen.
 - ◆ **Store** (When you store the channel and associated programme number)
 - Set to **OK** by pressing the **ENTER** () button.
- Channel mode**
- ◆ **P** (Programme mode): When completing tuning, the broadcasting stations in your area have been assigned to position numbers from P00 to P99. You can select a channel by entering the position number in this mode.
 - ◆ **C** (Air channel mode): You can select a channel by entering the assigned number to each air broadcasting station in this mode.
 - ◆ **S** (Cable channel mode): You can select a channel by entering the assigned number for each cable channel in this mode.

Skiping Unwanted Channels

You can exclude the channels of your choice from the channel scan operation. When you scan through the stored channels, those that you have chosen to skip are not displayed. All channels that you do not specifically choose to skip are displayed during scanning.

- 1 Press the **MENU** (□□) button to display the menu.
- 2 Press the **▲** or **▼** button to select **Channel1**, then press the **ENTER** (↵) button.
- 3 Press the **▲** or **▼** button to select **Add/Delete**, then press the **ENTER** (↵) button.
The **Add/Delete** menu is displayed with the current channel selected.
- 4 Press the **P** (⊖) or **P** (⊕) button to delete or add the required channel, then press the **ENTER** (↵) button.
- 5 Repeat step 4 for each channel to be deleted or added.
- 6 Press the **EXIT** button to exit.

➤ You can select these options simply by pressing the **ADD/DEL** button on the remote control.

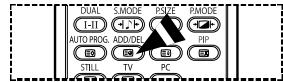
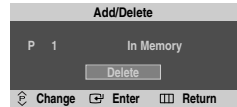
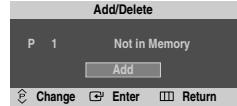

Sorting the Stored Channels

This operation allows you to change the programme numbers of stored channels. This operation may be necessary after using auto store.

- 1 Press the **MENU** (□□) button to display the menu.
- 2 Press the **▲** or **▼** button to select **Channel1**, then press the **ENTER** (↵) button.
- 3 Press the **▲** or **▼** button to select **Sort**, then press the **ENTER** (↵) button.
- 4 Select the channel that you wish to move by pressing the **▲** or **▼** button, then press the **ENTER** (↵) button.
- 5 Select the number of the programme to which the channel is to be moved by pressing the **▲** or **▼** button.
Press the **ENTER** (↵) button. The channel is moved to its new position and all other channels are shifted accordingly.
- 6 Repeat steps 4 to 5 until you have moved all the channels to the required programme numbers.
- 7 Press the **EXIT** button to exit.

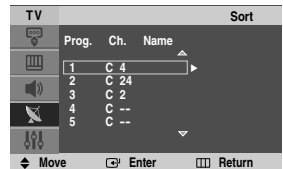

Assigning Names to Channels

Channel names will be assigned automatically when channel information is broadcast. These names can be changed, allowing you to assign new names.

- 1 Press the **MENU** (□□) button to display the menu.
- 2 Press the **▲** or **▼** button to select **Channel1**, then press the **ENTER** (↵) button.
- 3 Press the **▲** or **▼** button to select **Name**, then press the **ENTER** (↵) button.
- 4 Press the **▲** or **▼** button to select the channel to be assigned to a new name, then press the **ENTER** (↵) button.
- 5 Press the **▲** or **▼** button to select a letter (A-Z), a number (0-9), or a symbol. Move on to the previous or next letter by pressing the **◀** or **▶** button, then press the **ENTER** (↵) button.
- 6 Repeat steps 4 to 5 for each channel to be assigned to a new name.
- 7 Press the **EXIT** button to exit.

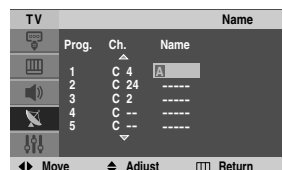

Changing the Picture Standard

You can select the type of picture which best corresponds to your viewing requirements.

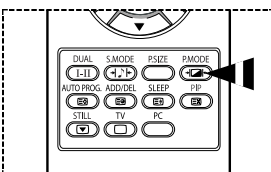
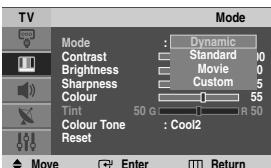
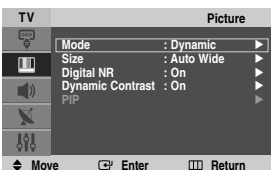

- 1 Press the **MENU** () button to display the menu.
- 2 Press the **▲** or **▼** button to select **Picture**, then press the **ENTER** () button.
- 3 Press the **ENTER** () button twice.
- 4 Select the required mode by pressing the **▲** or **▼** button, then press the **ENTER** () button.

Available modes: **Dynamic, Standard, Movie, Custom**

- The settings values may vary depending on the input source. (ex. RF, Video, Component, PC, or DVI)
- 5 Press the **EXIT** button to exit.

- You can select these options simply by pressing the **P.MODE** button on the remote control.
- - ◆ Choose Dynamic for viewing the TV during the day or when there is bright light in the room.
 - ◆ Choose Standard for the standard factory settings.
 - ◆ Choose Movie when viewing the movie.
 - ◆ Choose Custom if you want to adjust the settings according to personal preference.

Customizing the Picture Settings

Your television has several setting options that allow you to control the picture quality.

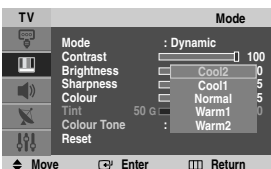
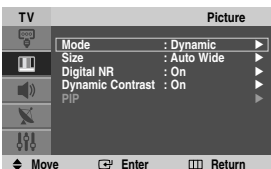

- 1 Press the **MENU** () button to display the menu.
- 2 Press the **▲** or **▼** button to select **Picture**, then press the **ENTER** () button.
- 3 Press the **ENTER** () button twice.
- 4 Select the required mode by pressing the **▲** or **▼** button, then press the **ENTER** () button.





Available modes: **Dynamic, Standard, Movie, Custom**

- 5 Select the required option by pressing the **▲** or **▼** button, then press the **ENTER** () button.
- 6 When you are satisfied with your setting, press the **ENTER** () button.
- 7 Press the **EXIT** button to exit.

- ◆ **Contrast – Brightness – Sharpness – Colour – Tint** (NTSC only)
Press the **◀** or **▶** button until you reach the optimal setting.
- ◆ **Colour Tone: Cool2/Cool1/Normal/Warm1/Warm2**
- ◆ **Reset:** You can return to the factory defaults picture settings.
 - The reset function is set for each picture mode and colour tone.

Selecting the Picture Size

You can select the picture size which best corresponds to your viewing requirements.

- 1 Press the **MENU** () button to display the menu.
- 2 Press the **▲** or **▼** button to select **Picture**, then press the **ENTER** () button.
- 3 Press the **▲** or **▼** button to select **Size**, then press the **ENTER** () button.
- 4 Select the required option by pressing the **▲** or **▼** button, then press the **ENTER** () button.



Available options: **Auto Wide, 16:9, Panorama, Zoom, 4:3**

- ◆ **Auto wide:** Expanding and pulling up the picture from 4:3 to 16:9 ratio.
- ◆ **16:9:** Sets the picture to 16:9 wide mode.
- ◆ **Panorama:** Sets the picture to the wide aspect ratio of a panoramic picture.
- ◆ **Zoom:** Magnify the size of the picture vertically on screen.
- ◆ **4:3:** Sets the picture to 4:3 normal mode.

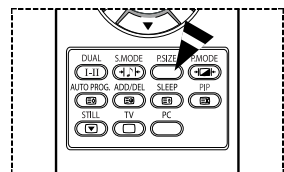
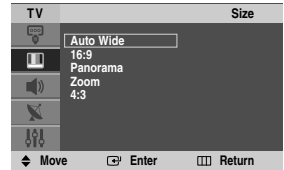
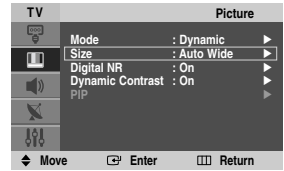

- 5 Press the **EXIT** button to exit.
 - You can change the picture size simply by pressing the **P.SIZE** button on the remote control.
 - If you change the picture size when PIP is On, PIP will automatically be turned Off.
 - Depending on the input source, the picture size options may vary.



Positioning and Sizing the screen using Zoom

- ◆ Resizing the screen using the **Zoom** enables the positioning and sizing of the screen to up/down direction using the **▲** or **▼** button as well as the screen size.
- ◆ Move the screen up/down using the **▲** or **▼** button after selecting the  by pressing the **◀** or **▶** button.
- ◆ Resize the screen vertically using the **▲** or **▼** button after selecting the  by pressing the **◀** or **▶** button.

Digital NR / Dynamic Contrast

- 1 Press the **MENU** () button to display the menu.
- 2 Press the **▲** or **▼** button to select **Picture**, then press the **ENTER** () button.
- 3 Select the required option by pressing the **▲** or **▼** button, then press the **ENTER** () button.

Available options: **Digital NR, Dynamic Contrast**

- 4 When you are satisfied with your setting, press the **ENTER** () button.
- 5 Press the **EXIT** button to exit.

- ◆ **Digital NR: On/Off**
If the signal received by the television is weak, you can activate this feature to reduce any static and ghosting that may appear on the screen.
- ◆ **Dynamic Contrast: On/Off**
Dynamic Contrast detects the visual signal input and adjusts to create optimum contrast.

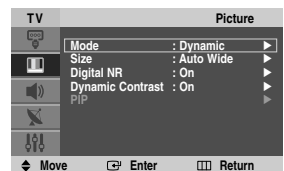

Viewing the Picture in Picture (PIP) (Available in PC mode)

You can display a sub picture within the main picture of PC. In this way you can watch TV program or monitor the video input from any connected devices while watching PC.

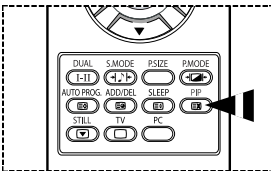
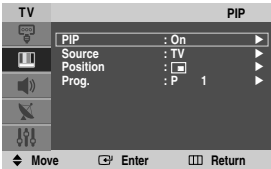
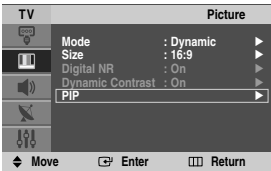

- 1 Press the **MENU** () button to display the menu.
- 2 Press the **▲** or **▼** button to select **Picture**, then press the **ENTER** () button.
- 3 Press the **▲** or **▼** button to select **PIP**, then press the **ENTER** () button.
- 4 Select the required option by pressing the **▲** or **▼** button, then press the **ENTER** () button.

Available options: **PIP (On/Off)**, **Source**, **Position**, **Prog.**

- 5 When you are satisfied with your setting, press the **ENTER** () button.
- 6 Press the **EXIT** button to exit.

◆ **PIP: On/Off**

You can activate or deactivate the PIP function.

- You can select these options simply by pressing the **PIP** button on the remote control.

◆ **Source: TV/Ext.1/Ext.2/AV/S-Video**

You can select a source of the sub-picture.

◆ **Position:** []/[]/[]/[]

You can select a position of the sub-picture.

◆ **Prog.**

You can select a channel of the sub-picture only when the **Source** is set to **TV**.

Table of PIP Settings

X - This PIP combination is not available.

O - This PIP combination is available.

Main \ Sub	TV	Ext.1	Ext.2	AV	S-Video	Component	DVI	PC
PC	O	O	O	O	O	X	X	X

- When the main picture is PC, the sub picture only supports "TV", "Ext.1", "Ext.2", "AV" and "S-Video". The sub picture does not support other input sources in this case.

Sound Features

- 1 Press the **MENU** (□□□) button to display the menu.
- 2 Press the **▲** or **▼** button to select **Sound**, then press the **ENTER** (↵) button.
- 3 Select the required option by pressing the **▲** or **▼** button, then press the **ENTER** (↵) button.

Available options: **Mode, Equalizer, Auto Volume**

- 4 When you are satisfied with your setting, press the **ENTER** (↵) button.
- 5 Press the **EXIT** button to exit.

◆ **Mode: Standard/Music/Movie/Speech/Custom**

You can select the type of special sound effect to be used when watching a given broadcast.

- You can select these options simply by pressing the **S.MODE** button on the remote control.

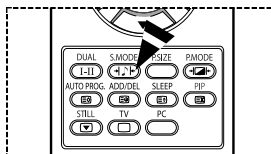
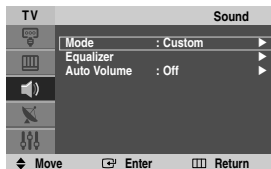

◆ **Equalizer: Balance/100/300/1K/3K/10K**

The television has several settings which allow you to control the sound quality.

- If you make any changes to these settings, the sound mode is automatically switched to **Custom**.

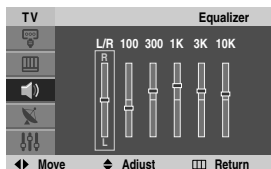

◆ **Auto Volume: On/Off**

Each broadcasting station has its own signal conditions, and so it is not easy to adjust the volume every time the channel is changed. This feature lets you automatically adjust the volume of the desired channel by lowering the sound output when the modulation signal is high or by raising the sound output when the modulation signal is low.

Time Features

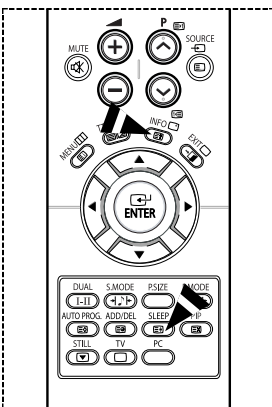
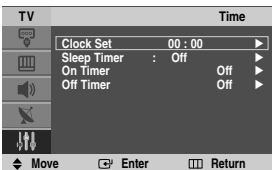
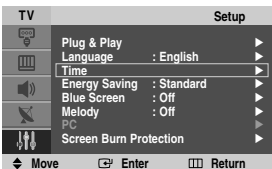

- 1 Press the **MENU** () button to display the menu.
- 2 Press the **▲** or **▼** button to select **Setup**, then press the **ENTER** () button.
- 3 Press the **▲** or **▼** button to select **Time**, then press the **ENTER** () button.
- 4 Select the required option by pressing the **▲** or **▼** button, then press the **ENTER** () button.

Available options: **Clock Set, Sleep Timer, On Timer, Off Timer**

- 5 When you are satisfied with your setting, press the **ENTER** () button.
- 6 Press the **EXIT** button to exit.

◆ Clock Set

You can set the television clock so that the current time is displayed when pressing the **INFO** button on the remote control. You must also set the time if you wish to use the automatic on or off timers.

- Press the **◀** or **▶** button to select **Hour** or **Minute**. Set these by pressing the **▲** or **▼** button.
- You can set the hour and minute directly by pressing the numeric buttons on the remote control.

◆ Sleep Timer

You can select a time period of between 30 and 180 minutes after which the television automatically switches to standby mode.

- Select the preset time interval (**Off, 30, 60, 90, 120, 150, or 180**) for staying on by pressing the **▲** or **▼** button.
- You can select these options simply by pressing the **SLEEP** button on the remote control. If the sleep timer is not yet set, **Off** is displayed. If it is already set, the remaining time before which the television switches to standby mode is displayed.

◆ On Timer / Off Timer

You can set the On/Off timers so that the television will switch on or off automatically at the time you select.

☛ You must set the clock first.

- **On Timer:** Select **Hour, Minute, Programme, or Volume** by pressing the **◀** or **▶** button. Set these by pressing the **▲** or **▼** button. To activate **On Timer** with the setting satisfied, set **Setup** to **On** by **▲** or **▼** button.
 - You can set the hour and minute directly by pressing the numeric buttons on the remote control.
- **Off Timer:** Select **Hour** or **Minute** by pressing the **◀** or **▶** button. To activate **Off Timer** with the setting satisfied, set **Setup** to **On** by **▲** or **▼** button.
 - You can set the hour and minute directly by pressing the numeric buttons on the remote control.

☛ Auto Power Off

When you set the timer "On", the television will eventually turn off, if no controls are operated for 3 hours after the TV was turned on by timer. This function is only available in timer "On" mode and prevents overheating or leakages, which may occur if a TV is on for too long (when you are on vacation, for example).

Language / Blue Screen / Melody / Energy Saving

- 1 Press the **MENU** (□□□) button to display the menu.
- 2 Press the **▲** or **▼** button to select **Setup**, then press the **ENTER** (↵) button.
- 3 Select the required option by pressing the **▲** or **▼** button, then press the **ENTER** (↵) button.

Available options: **Language, Blue Screen, Melody, Energy Saving**

- 4 When you are satisfied with your setting, press the **ENTER** (↵) button.
- 5 Press the **EXIT** button to exit.

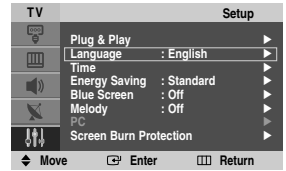

◆ **Language**

It is variable depending on the model. When you start using the television for the first time, you must select the language which will be used for displaying menus and indications.

◆ **Blue Screen: On/Off**

If no signal is being received or the signal is very weak, a blue screen automatically replaces the noisy picture background. If you wish to continue viewing the poor picture, you must set the **Blue Screen** to **Off**.

◆ **Melody: On/Off**

You can hear melody sound when the television is powered on or off.

◆ **Energy Saving: Standard/Super Saving**

Standard: Operates in standard mode regardless of the surrounding illumination.

Super Saving: Enters maximum power saving mode regardless of the surrounding illumination.

Screen Burn Protection

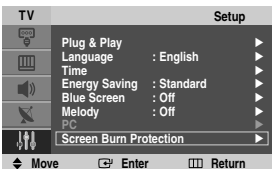

To reduce the possibility of screen burn, this unit is equipped with screen burn prevention technology. This technology enables you to set picture movement up/down (Vertical Line) and side to side (Horizontal Dot). The Time setting allows you to program the time between movement of the picture in minutes.

- 1 Press the **MENU** () button to display the menu.
- 2 Press the **▲** or **▼** button to select **Setup**, then press the **ENTER** () button.
- 3 Press the **▲** or **▼** button to select **Screen Burn Protection**, then press the **ENTER** () button.
- 4 Select the required option by pressing the **▲** or **▼** button, then press the **ENTER** () button.
Available options: **Pixel Shift**, **All White**, **Signal Pattern**
- 5 When you are satisfied with your setting, press the **ENTER** () button.
- 6 Press the **EXIT** button to exit.

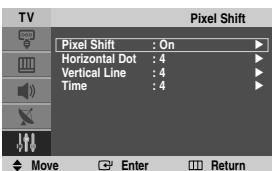
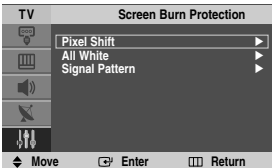

◆ **Pixel Shift:** Using this function, you can minutely move pixels on the PDP in horizontal or vertical direction to minimize after image on the screen.

- Set **Pixel Shift** to **On** by pressing the **▲** or **▼** button, then press the **ENTER** () button.
- Select the required option by pressing the **▲** or **▼** button, then press the **ENTER** () button.

Available options: **Horizontal Dot**, **Vertical Line**, **Time**

➤ Optimum condition for pixel shift;

Horizontal Dot	4
Vertical Line	4
Time (minute)	4

- ◆ **All White:** This function helps remove after images on the screen by changing the colour of pixels to white. Use this function when there are remaining after images or symbols on the screen especially when you displayed a still image on the screen for a long time.
- ◆ **Signal Pattern:** This function helps remove after images on the screen by moving all the pixels on the PDP according to a pattern. Use this function when there are remaining after images or symbols on the screen especially when you displayed a still image on the screen for a long time.
- To remove after images on the screen, use either "**All White**" or "**Signal Pattern**" function. Although both of the two functions remove after images on the screen, "**Signal Pattern**" is more effective.
- The after image removal function has to be executed for a long time (approximately 1 hour) to effectively remove after images on the screen.
- If after image is not improved after the execution of the function, repeat the function again.
- Press any button on the remote control to cancel this feature.

Setting up Your PC Software (Windows only)

The Windows display-settings for a typical computer are shown below. But the actual screens on your PC will probably be different, depending upon your particular version of Windows and your particular video card. But even if your actual screens look different, the same, basic set-up information will apply in almost all cases. (If not, contact your computer manufacturer or Samsung Dealer.)

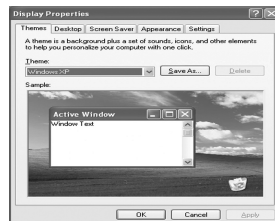

- 1 Right click the mouse on the Windows Desktop, then click on **Properties**. The **Display Properties** will be displayed.
- 2 Click on **Settings** tab, then set the Display Mode with reference to the Display Modes Table. You do not need to change the Colours settings.
- 3 Click on **Advanced**. A new settings dialog box will be displayed.
- 4 Click on the **Monitor** tab, then set the **Screen refresh rate** with reference to the Display Modes Table. Set the Vertical Frequency and Horizontal Frequency individually if you can do so instead of setting the **Screen refresh rate**.
- 5 Click on **OK** to close the window, then Click on **OK** button to the **Display Properties** window. Automatic re-booting may commence at this moment.

Input Mode (PC)

Both screen position and size will vary depending on the type of PC monitor and its resolution. The table below shows all of the display modes that are supported:

Video Signal	Resolution (Dot X Line)	Vertical frequency (Hz)	Horizontal frequency (kHz)	Vertical polarity	Horizontal polarity	
IBM PC / AT Compatible	640 x 350	70.086	31.469	P	N	
	720 x 400	70.087	31.469	N	P	
	640 x 480		59.940	31.469	N	N
			70.000	35.000	N/P	N/P
			72.809	37.861	N	N
			75.000	37.500	N	N
	800 x 600		56.250	35.156	N/P	N/P
			60.317	37.879	P	P
			70.000	43.750	N/P	N/P
			72.188	48.077	P	P
	848 x 480		75.000	46.875	P	P
			60.000	31.020	P	P
			74.769	37.684	P	N
	1024 x 768		60.004	48.363	N	N
			70.069	56.476	N	N
			72.000	57.672	N/P	N/P
75.029			60.023	P	P	





(N: Negative / P: Positive)

- ◆ The interlace mode is not supported.
- ◆ The television might operate abnormally if a non-standard video format is selected.
- ◆ 480i/p, 576i/p, 720p, or 1080i is not available in PC mode.

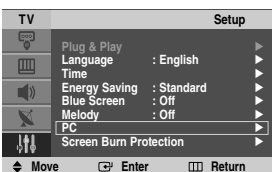
Setting the PC

➤ Preset to the **PC** mode by pressing the **SOURCE** () button.



- 1 Press the **MENU** () button to display the menu.
- 2 Press the **▲** or **▼** button to select **Setup**, then press the **ENTER** () button.
- 3 Press the **▲** or **▼** button to select **PC**, then press the **ENTER** () button.
- 4 Select the required option by pressing the **▲** or **▼** button, then press the **ENTER** () button.

Available options: **Image Lock, Position, Image Reset, Auto Adjustment**

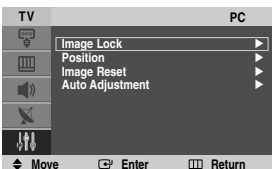

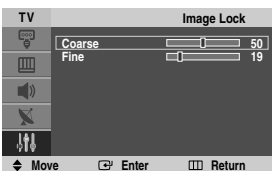

- 5 When you are satisfied with your setting, press the **ENTER** () button.
- 6 Press the **EXIT** button to exit.



◆ **Image Lock: Coarse/Fine**

The purpose of picture quality adjustment is to remove or reduce picture noise. If the noise is not removed by Fine-tuning alone, then adjust the frequency as best as possible (coarse) and Fine-tune again.

After the noise has been reduced, re-adjust the picture so that it is aligned on the center of screen.

- 1 Press the **▲** or **▼** button to select **Coarse** or **Fine**, then press the **ENTER** () button.
- 2 Press the **◀** or **▶** button to adjust the screen quality, vertical stripes may appear or the picture may be blurry. Press the **ENTER** () button.

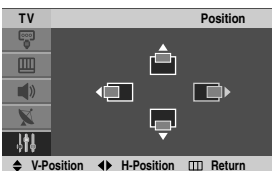

◆ **Position:**

Adjust the PC's screen positioning if it does not fit the TV screen.

- 1 Press the **▲** or **▼** buttons to adjust the **V-Position**.
- 2 Press the **◀** or **▶** buttons to adjust the **H-Position**, then press the **ENTER** () button.

Image Reset has completed.

◆ **Image Reset:**

You can replace all image settings with the factory default values.

Auto Adjustment in progress.
Please wait.

◆ **Auto Adjustment:**

Auto adjustment allows the PC screen of set to self-adjust to the incoming PC video signal.

The values of fine, coarse and position are adjusted automatically.

Teletext Feature (depending on the model)

Most television stations provide written information services via teletext. The index page of the teletext service gives you information on how to use the service. In addition, you can select various options to suit your requirements by using the remote control buttons.

- For teletext information to be displayed correctly, channel reception must be stable. Otherwise, information may be missing or some pages may not be displayed.

1 (teletext on/mix)

Press to activate teletext mode after selecting the channel providing the teletext service. Press it again to overlap the teletext with the current broadcasting screen.

2 (sub-page)

Used to display the available sub-page.

3 (size)

Press to display the double-size letters in the upper half of the screen. For lower half of the screen, press it again. To display normal screen, press it once again.

4 (store)

Used to store the teletext pages.

5 (hold)

Used to hold the display on a given page if the selected page is linked with several secondary pages which follow on automatically. To resume, press it again.

6 (page up)

Used to display the next teletext page.

7 (mode)

Press to select the teletext mode (LIST/FLOF). If you press it in the LIST mode, it switches into the List save mode. In the List save mode, you can save teletext page into list using the **4** (store) button.

8 (page down)

Used to display the previous teletext page.

9 (index)

Used to display the index (contents) page at any time while you are viewing teletext.

10 (reveal)

Used to display the hidden text (answers to quiz games, for example). To display normal screen, press it again.

11 **Coloured buttons (red/green/yellow/blue)**

If the FASTEXT system is used by a broadcasting company, the different topics covered on a teletext page are colour-coded and can be selected by pressing the coloured buttons. Press one of them corresponding to the required. The page is displayed with other coloured information that can be selected in the same way. To display the previous or next page, press the corresponding coloured button.

12 (cancel)

Used to display the broadcast when searching for a page.

- You can change teletext pages by pressing the numeric buttons on the remote control.

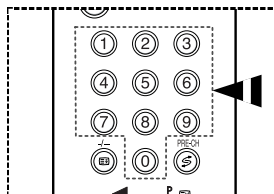
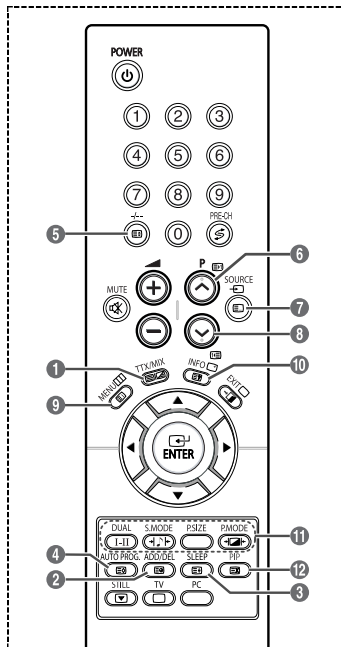

continued..

Teletext Feature (depending on the model)

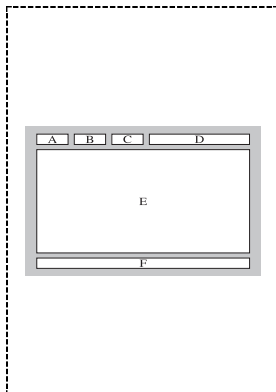

The teletext pages are organized according to six categories:

Part	Contents
A	Selected page number.
B	Broadcasting channel identity.
C	Current page number or search indications.
D	Date and time.
E	Text.
F	Status information. FASTEXT information.

- Teletext information is often divided between several pages displayed in sequence, which can be accessed by:
 - ◆ Entering the page number
 - ◆ Selecting a title in a list
 - ◆ Selecting a coloured heading (FASTEXT system)
- Press the **EXIT** button to exit from the teletext display.

Installing the Display on the Wall Attachment Panel

- Refer to the correct installation guide according to your wall bracket.

Installation Notes

- ◆ Contact a technician for installing the wall bracket.
- ◆ Samsung Electronics is not responsible for any damages to the product or harm to customers when the installation is done by the customer.
- ◆ This product is for installing on cement walls. The product may not stay in place when installed on plaster or wood.

Components

- ◆ Only use the components and accessories shipped with the product.

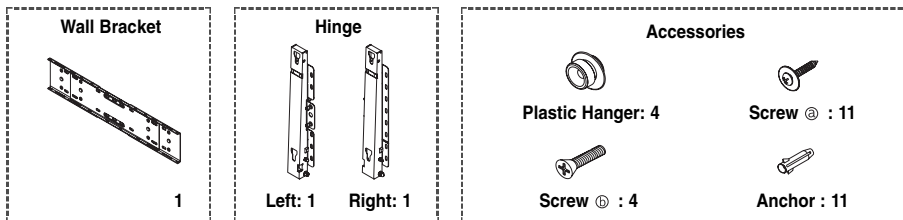

Wall Bracket Angle Adjustment

- Adjust the bracket angle to -2° before installing it on the wall.

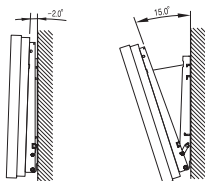

- 1 Fix the product to the wall bracket.
- 2 Hold the product at the top in the center and pull it forward (direction of the arrow) to adjust the angle. (See the figure to the right)
- 3 You can adjust the bracket angle between -2° and 15° .

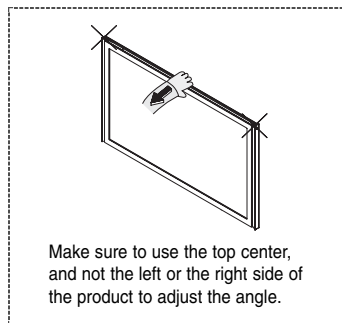

Troubleshooting

Before contacting the Samsung after-sales service, perform the following simple checks.

If you cannot solve the problem using the instructions below, note the model and serial number of the television and contact your local dealer.

No sound or picture

- ◆ Check that the mains lead has been connected to a wall socket.
- ◆ Check that you have pressed the \odot (Power) button (On/Off) on the front panel and the **POWER** button on the remote control.
- ◆ Check the picture contrast and brightness settings.
- ◆ Check the volume.

Normal picture but no sound

- ◆ Check the volume.
- ◆ Check whether the volume **MUTE** button on the remote control has been pressed.

No picture or black and white picture

- ◆ Adjust the colour settings.
- ◆ Check that the broadcast system selected is correct.

Sound and picture interference

- ◆ Try to identify the electrical appliance that is affecting the television, then move it further away.
- ◆ Plug the television into a different mains socket.

Blurred or snowy picture, distorted sound

- ◆ Check the direction, location and connections of your aerial.
This interference often occurs due to the use of an indoor aerial.

Remote control malfunctions

- ◆ Replace the remote control batteries.
- ◆ Clean the upper edge of the remote control (transmission window).
- ◆ Check that the "+" and "-" ends of the batteries are inserted correctly.
- ◆ Check that the batteries are drained.

– AFTER SALES SERVICE

- Do not hesitate to contact your retailer or service agent if a change in the performance of your product indicates that a faulty condition may be present.



ELECTRONICS



Correct Disposal of This Product (Waste Electrical & Electronic Equipment)

(Applicable in the European Union and other European countries with separate collection systems)

 This marking shown on the product or its literature, indicates that it should not be disposed with other household wastes at the end of its working life. To prevent possible harm to the environment or human health from uncontrolled waste disposal, please separate this from other types of wastes and recycle it responsibly to promote the sustainable reuse of material resources.

Household users should contact either the retailer where they purchased this product, or their local government office, for details of where and how they can take this item for environmentally safe recycling.

Business users should contact their supplier and check the terms and conditions of the purchase contract. This product should not be mixed with other commercial wastes for disposal.