

Quick Setup Guide

SERIES 4+
430

Congratulations on the purchase of your new Samsung TV. Read this setup guide to get your TV up and running quickly.

STOP
Please do not return this unit. If you have problems operating your TV, call: 1-800-SAMSUNG (1-800-726-7864). For web support please visit: www.samsung.com/support

1-800-SAMSUNG (1-800-726-7864)
Samsung Electronics America, Inc.
85 Challenger Road Ridgefield Park, NJ 07660-2112
Samsung Electronics Canada Inc.
55 Standish Court Mississauga, Ontario L5R 4B2
Call Center hours of operation: Mon-Sun, 9:00 AM -12 AM EST.
To register this product, visit: www.samsung.com/register.

Step 1: Install the Stand

Follow the steps below to connect the TV to the stand.

NOTE

- Make sure to distinguish between the front and back of the Stand and Guide Stand when assembling them.
- Make sure that at least two persons lift and move the PDP TV.
- Stand the product up and fasten the screws. If you fasten the screws with the PDP TV placed down, it may lean to one side.

- With your TV upright, connect the TV to the Stand as shown.
- Fasten the two screws (M4 X L16) at position 1, and then fasten the two screws (M4 X L16) at position 2.



Step 2: Install the Batteries into the Remote

To install batteries into your remote control, follow these steps:

- Lift the cover on the back of the remote upward as shown in the figure to the right.
- Install two AAA batteries.
 - Make sure to match the + and - ends of the batteries to the diagram in the battery compartment.
- Replace the cover.

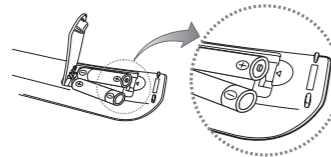

Step 3: Connect Power and Antenna or Cable

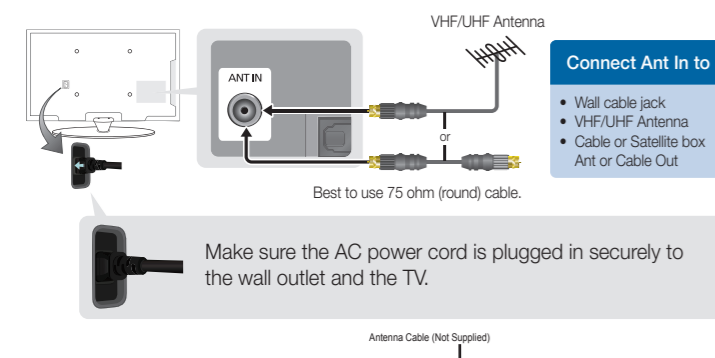

Step 4: Connect External Devices

Connecting an AV device (DVD/ Blu-ray player, cable/satellite box, etc.)

Use one of the connections below to connect your TV to an external AV device. We recommend using HDMI for the highest picture quality.

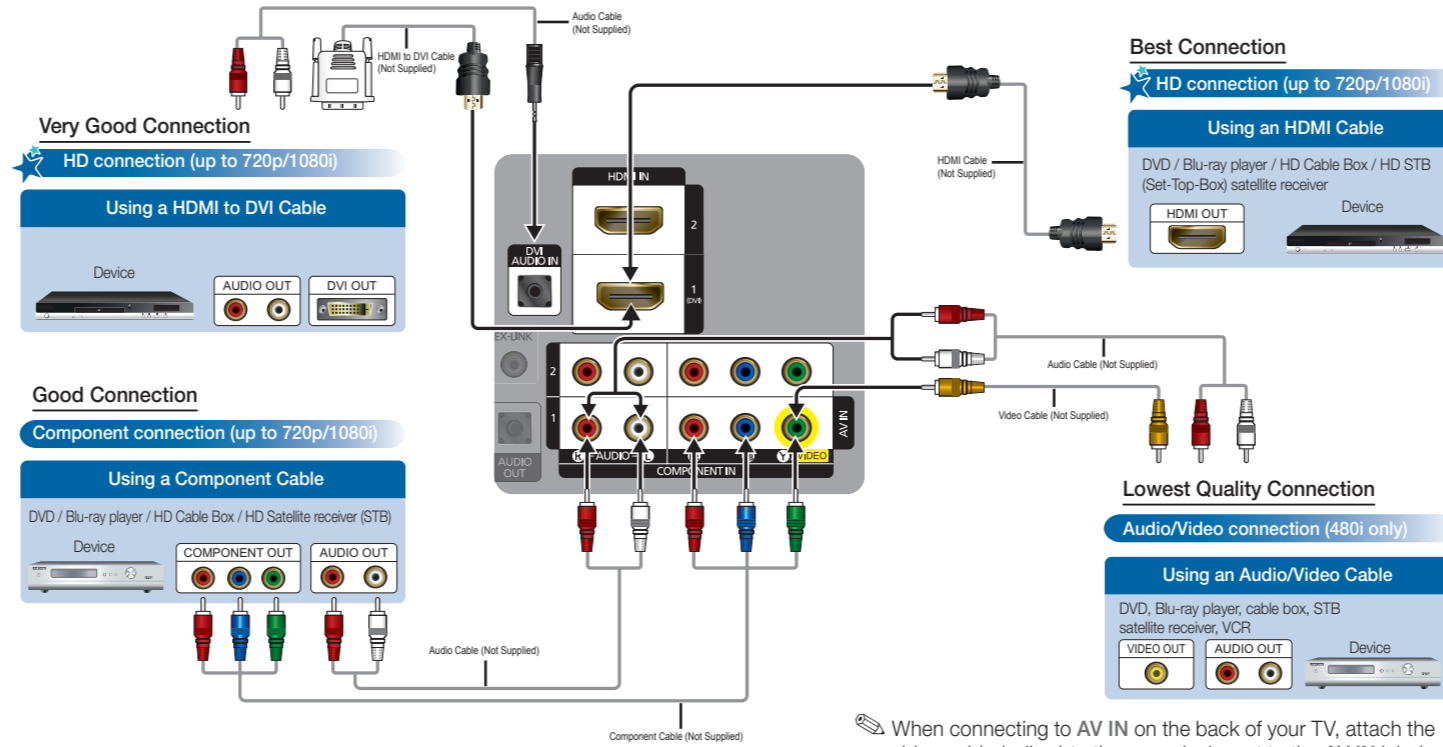

When connecting to AV IN on the back of your TV, attach the video cable (yellow) to the green jack next to the AV IN label. The jack will not match the color of the video cable (yellow).

Connecting an audio device (Home Theater, etc.)

Connect your TV to your Home Theater or other audio device to enjoy enhanced Sound quality.

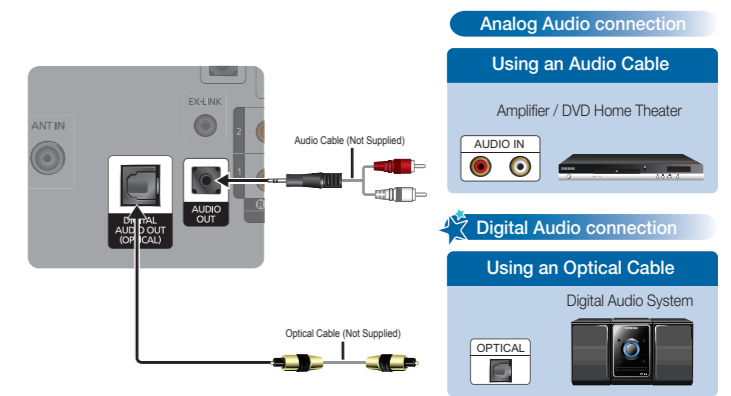

Connecting a PC

Connect your TV to a PC to use it as a Monitor.

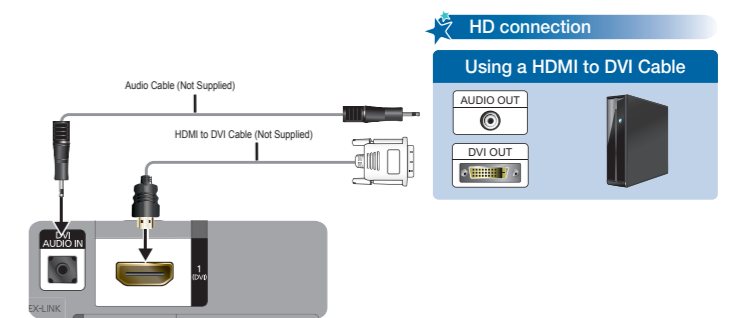

Step 5: Run Plug & Play

When you turn on your TV for the first time, it automatically launches the Plug & Play function. With Plug & Play, you can select the On Screen Display language, set the clock mode, and launch the TV's channel memorizing process. It also displays connection instructions similar to those in this guide.

To navigate while Plug & Play is running, press the Up, Down, Left or Right arrow buttons on your remote. To make a selection, press the ENTER button.

To skip a screen, press the MENU button. To turn on your TV, press the POWER button on the remote or on the TV. To run Plug & Play, follow these steps:

- Using your remote control, select the language for the On Screen Display (OSD), and then press the ENTER button.
- Select **Home Use**, and then press the ENTER button. If you select **Store Demo**, the TV will reset your picture and audio settings every 30 minutes.
- Select the **Antenna Source** to memorize. you must select **Antenna Source** to same type as your cable system type. After selecting source, select **Start**; then press the ENTER button on your remote.

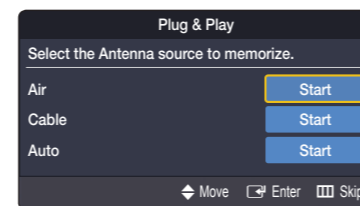
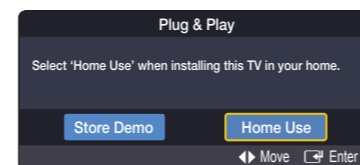
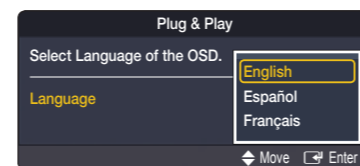

- Most cable systems are Standard(STD) systems. If you are not sure about what kind of cable system you have, contact your cable company.
- If your TV is attached to a cable or satellite box, skip Steps 3 through 5. After Plug & Play is complete, set your TV to Channel 3 or 4, according to the directions for your cable or satellite box.

- The TV memorizes the available channels. This process can take up to 45 minutes.

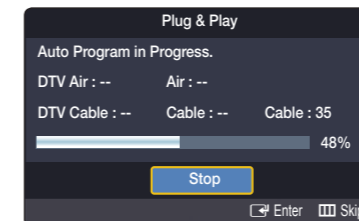

- After the TV has memorized the channels, choose the **Clock Mode**. Select **Auto** if you have a digital channel in your area. Select **Manual** if you don't, or if you have a cable or satellite box. When done, press the ENTER button.

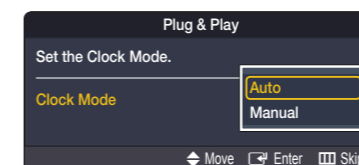

- If you select **Manual**, the clock setting screen appears.

- Select the daylight savings time setting: **Off**, **On** or **Auto** and then press the ENTER button.

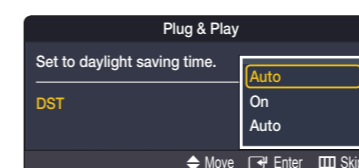

- Select the time zone in which you live, and then press ENTER.
- After the time zone screen, The connection method for best HD screen quality is displayed. Press Right arrow button on your remote to view each screen in succession. Press the Blue button to skip this section.
- The **Enjoy your TV.** screen appears. Then press the ENTER button.

If You Want to Rerun Plug & Play

- Press the SOURCE button on your remote, then select TV mode.
- Press the MENU button on your remote to display the menu.
- Press the ▲ or ▼ button to select **Setup**, and then press the ENTER button.
- Press ENTER again to select **Plug & Play**.



Step 6: Remote Control

Remote Control Buttons and Functions

This is a special remote control for the visually impaired and has Braille points on the Power, Channel and Volume buttons.

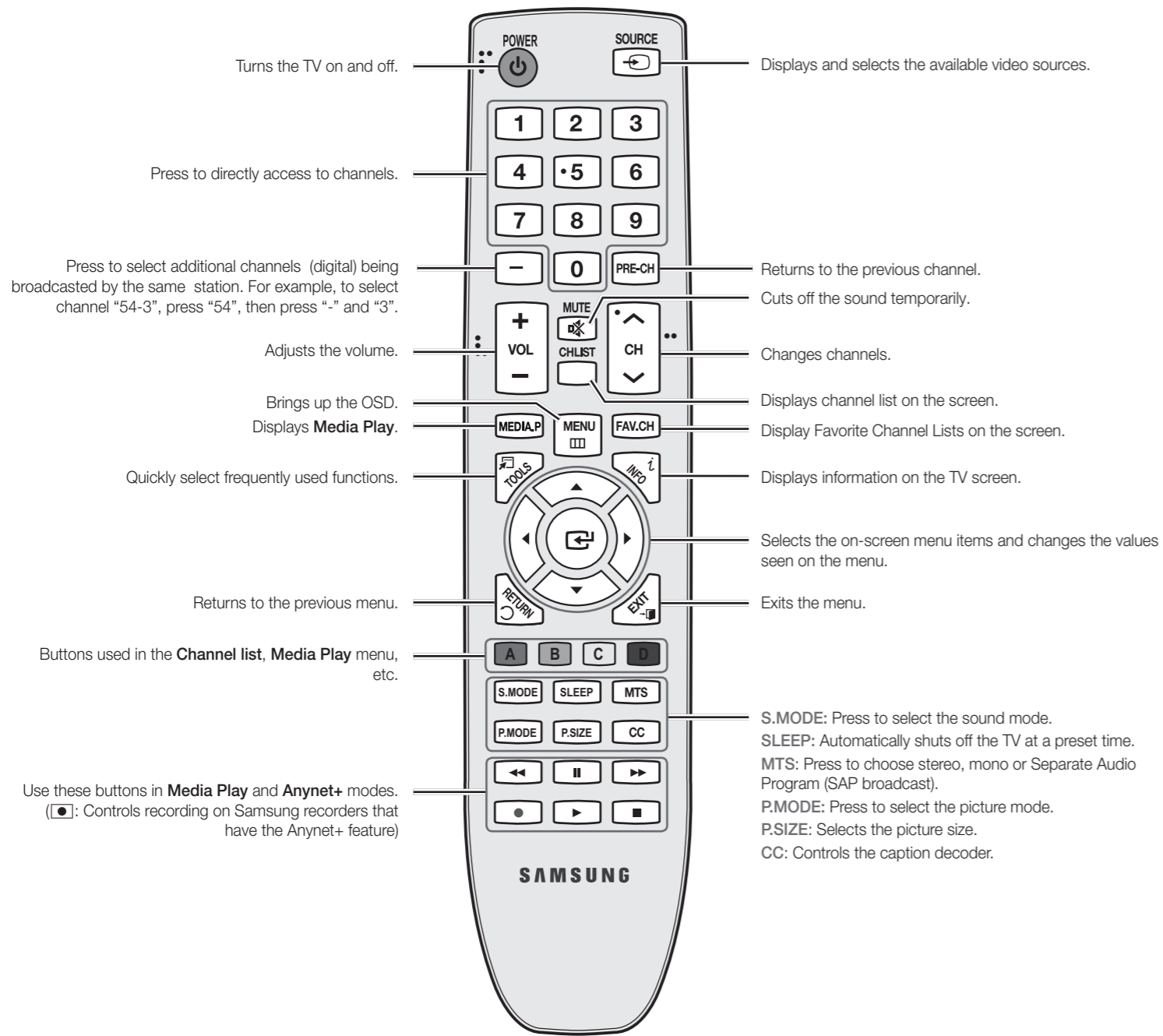

Changing Channels and Adjusting the Volume

Adjust the volume by pressing the Volume button on the remote.

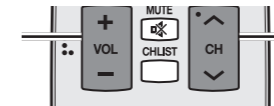

Change the channels by pressing the Channel button on the remote.

If your TV is attached to a cable or satellite box, change the channel using the box's remote.

You can also change the channels by pressing the **▼ CH ▲** button on the front panel of your TV and adjust the volume by pressing the **-VOL+** button.

Selecting a Source

To watch a movie on your Blu-ray player or watch your favorite TV show, you must select the correct source. A source is a device, such as a Blu-ray/DVD player, a cable/satellite box, antenna or a cable TV input. Sources can be connected to your TV through the HDMI, DVI, Component, Composite, or through the Antenna or Cable In connections.

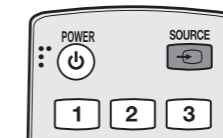

To view the signal from a source connected to the HDMI, DVI, Component, or Composite jack, press the SOURCE button on your remote. Each time you press the SOURCE button, you change to a different source.

Viewing the On Screen Menus

To view the On Screen Menus, follow these steps:

- With the power on, press the MENU button on your remote. The main menu appears. The menu's left side has the following menu options: **Picture**, **Sound**, **Channel**, **Setup**, **Input**, **Application**, and **Support**.
- Press the **▲** or **▼** button on your remote to select a menu option, and then press the ENTER button.
- When done using the menu, press the EXIT button on your remote to exit.



Changing the Screen Size

Your TV has several screen size options, each designed to work best with specific types of video input. If you have a cable box or satellite receiver, it may have its own set of screen sizes as well.

To change the screen size, press the P.SIZE button on your remote. The first time you press it, your TV displays the current setting. Thereafter, each time you press the P.SIZE button, you change the size of the picture on the screen.

The following sizes are available:

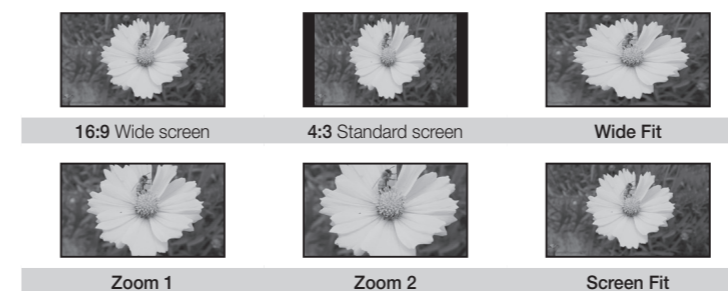

Screen Fit: Displays the full image without any cut-off when HDMI (720p / 1080i / 1080p) or Component (1080i / 1080p) signals are inputted.

Changing the Picture Mode

Your TV has three preset **Picture** modes with factory adjusted settings, each designed to give you an excellent picture under specific conditions.

To change the **Picture** mode, press the P.MODE button on your remote. The first time you press it, your TV displays the current setting. Thereafter, each time you press the P.MODE button, you change the mode of the picture on the screen.

The **Picture** modes are listed and described in the table below:

Mode	Description
Dynamic	Brightens picture. For a vibrant, enhanced image in brightly lit or sunny room.
Standard	For a bright, detailed picture in a normally lit room.
Movie	For a studio quality cinema picture in a dimly lit or dark room.

To change the **Picture** mode, follow these steps:

- With the TV on, press the MENU button on your remote, then select **Picture**.
- Select **Mode**, then Press the ENTER button.
- On the **Mode** menu in **Picture**, use the **▼** or **▲** on your remote to select the picture mode you want.
- Press the ENTER button to finish the change.

Setting the Clock

Before you can use your TV's On/Off Timer, you must set the clock. To set the clock, follow these steps:

- Turn on your TV, press the MENU button on your remote, then select **Setup** → **Time**.
- Select **Clock Mode**, and then press the ENTER button.
- Choose **Auto** or **Manual**.
 - If you select **Auto**, set the current time automatically using the time from digital broadcast.
 - If you select **Manual**, you can set the **Month**, **Day**, **Year**, **Hour**, **Minute** and **am/pm** directly by pressing up, down, left and right arrow button on your remote.
- Press the RETURN button on your remote when done.

Connecting a USB Device for Media Play

You can enjoy photo and music files stored on a USB device by connecting it to the TV and using the Media Play feature. To connect a USB device for Media Play, follow these steps:

- Turn on your TV.
- Connect a USB device containing photo or music files to the USB jack on the side of the TV.
- When the **Input** selection screen is displayed, press the **▶** button to select **Media Play (USB)**, then press the ENTER button.

