

SAMSUNG

COLOUR TELEVISION

CS29A6/CS29A7/CS29M20

CS29M21/CS29M30/CS29Z4

CS34A11/CS34M21/CS34M30

WS32A11/WS32M21/WS32M30

Owner's Instructions

Before operating the unit,
please read this manual thoroughly,
and retain it for future reference.

**ON-SCREEN MENUS
PICTURE IN PICTURE (OPTION)
TELETEXT (OPTION)**

**VIRTUAL
DOLBY
SURROUND**

Register your product at www.samsung.com/global/register

Contents

◆ CONNECTING AND PREPARING YOUR TELEVISION	
■ View of Your Television (depending on the model)	5
■ Infrared Remote Control	7
■ Inserting the Batteries in the Remote Control.....	9
■ Connecting to an Aerial or Cable Television Network	10
■ Switching Your Television On and Off.....	11
■ Placing Your Television in Standby Mode	11
■ Becoming Familiar with the Remote Control	12
■ Plug & Play Feature.....	13
■ Viewing the Demonstration.....	14
■ Choosing Your Language.....	14
◆ SETTING THE CHANNELS	
■ Storing Channels Automatically.....	15
■ Sorting the Stored Channels	16
■ Storing Channels Manually.....	17
■ Skipping Unwanted Channels	19
■ Assigning Names to Channels	20
■ Fine Tuning Channel Reception.....	21
◆ USING YOUR TELEVISION	
■ Using the LNA (Low Noise Amplifier) feature (depending on the model)	22
■ Changing the Picture Standard	23
■ Adjusting the Picture Settings.....	24
■ Selecting the Color Tone	25
■ Selecting the Picture Size (depending on the model).....	26
■ Selecting the Digital NR.....	26
■ Using the Tilt Control Feature.....	27
■ Setting the Blue Screen.....	27
■ Freezing the Current Picture	28
■ Changing the Sound Standard	28
■ Adjusting the Sound Settings	29
■ Extra Sound Settings (depending on the model)	30
■ Selecting the Sound Mode (depending on the model)	31
■ Selecting the Melody	32
■ Setting and Displaying the Current Time.....	33

Contents (continued)

◆ USING YOUR TELEVISION (continued)	
■ Setting the Sleep Timer	34
■ Switching the Television On and Off Automatically	35
■ Setting the Preferred Volume Level/Channel	36
■ Viewing an External Signal Source/Edit Name (depending on the model)...	37
■ Viewing the Picture In Picture (PIP) (depending on the model)	38
◆ USING THE TELETEXT FEATURE	
■ Teletext Feature (depending on the model)	41
■ Displaying the Teletext Information (depending on the model)	41
■ Selecting a Page by Number (depending on the model)	42
■ Using FLOF to Select a Page (depending on the model)	43
■ Storing Teletext Pages (depending on the model)	43
◆ ADDITIONAL INFORMATION ON CONNECTIONS	
■ Connecting to the External Input/Outputs	44
■ Connecting to the DVD Player or DTV receiver (depending on the model) ..	45
■ Connecting to the Audio Output	45
■ Connecting to the RCA Input	46
■ Connecting to the S-Video Input	46
■ Viewing Pictures From External Sources	47
◆ RECOMMENDATIONS FOR USE	
■ Automatic Degaussing to Remove Color Patches	48
■ Troubleshooting: Before Contacting Service Personnel	48

Symbols



Press



Important



Note

View of Your Television (depending on the model)

➤ The actual configuration on your TV may be different, depending on your model.

Control Panels

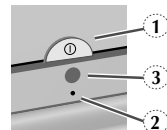
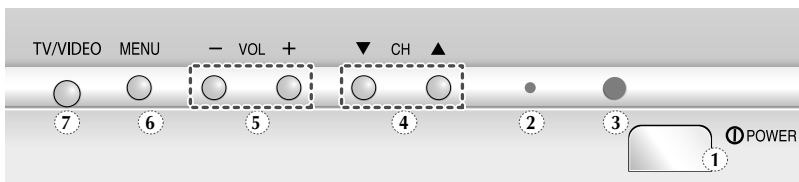
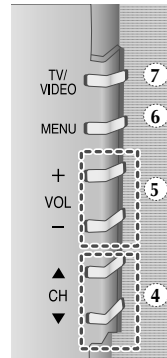
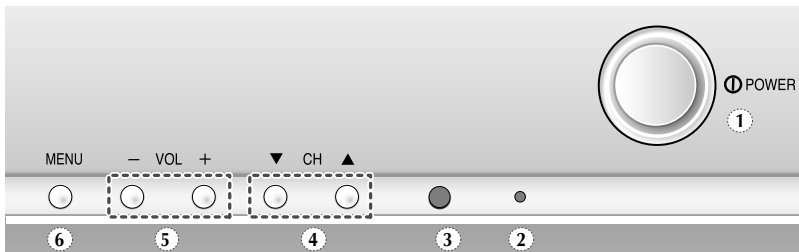

- | | |
|--------------------------|---------------------------|
| 1) Power On/Off | 5) Volume Adjustment |
| 2) Standby Indicator | 6) Menu Display |
| 3) Remote Control Sensor | 7) Input source selection |
| 4) Channel Selection | |

➤ Using the Buttons on the Panel

If the remote control no longer works or you have lost it, you can use controls on the panel of the TV to:

- ◆ Switch on the TV when it is in Standby mode and select channels (**▼ CH ▲**).
- ◆ Access the menu (**MENU**).
- ◆ Adjust the volume (- **VOL** +).
- ◆ Switch among Video input modes (**TV/VIDEO**).

View of Your Television (depending on the model) (continued)

Connection Panels

Side of the TV (RCA Model)

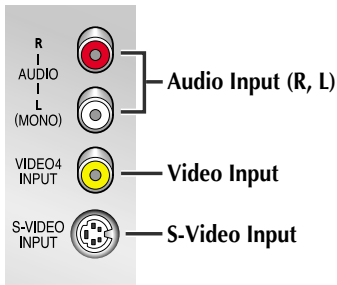

Side of the TV (SCART Model)

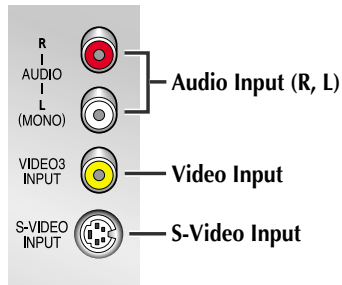

Rear of the TV (depending on the model)

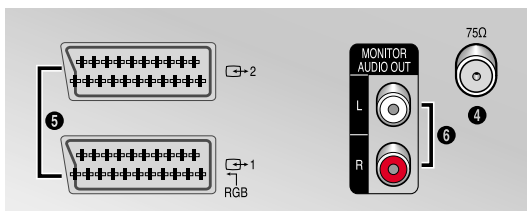
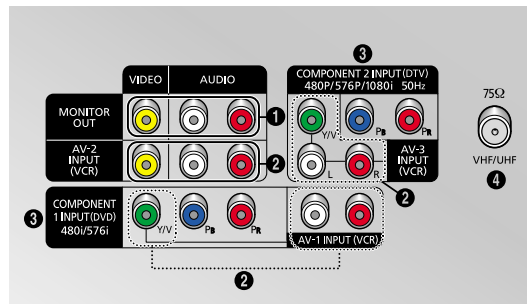
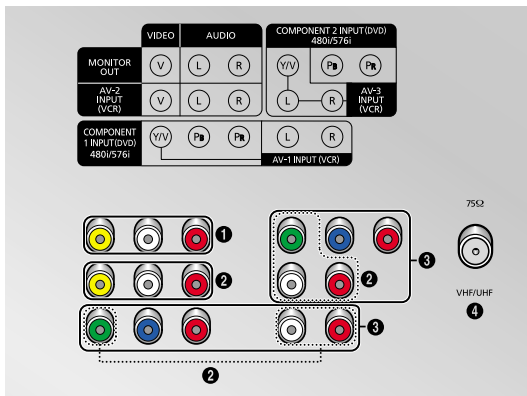

- ❶ **MONITOR OUT (VIDEO / L-AUDIO-R)**
Outputs for external devices.
- ❷ **AV 1 (VCR) -VIDEO/AUDIO(L/R)**
AV 2 (VCR) -VIDEO/AUDIO(L/R)
AV 3 (VCR) -VIDEO/AUDIO(L/R)
Inputs or outputs for external devices, such as VCR,DVD, video game device or video disc players.
- ❸ **COMPONENT (DVD)**
VIDEO (Y/Pb/P_r) and AUDIO (L/R) inputs for Component.
 - Available format for DTV inputs; 480P/576P/1080i 50 Hz.
 - If you change the output resolution of an external device at will, the video from the device may not be displayed on the TV because the resolution is not automatically switched. Check the available input ports for each resolution.

	480i/576i	480P/576P	1080i (50Hz)
Component1	○	X	X
Component2	X	○	○

- ❹ **VHF/UHF (75Ω)**
75Ω Coaxial connector for Aerial/
Cable Network.
- ❺ **1 / 2 (SCART)**
Inputs or outputs for external devices, such as VCR, DVD, video game device or video disc players.
- ❻ **MONITOR AUDIO OUT**
Audio Output for external devices.

Infrared Remote Control

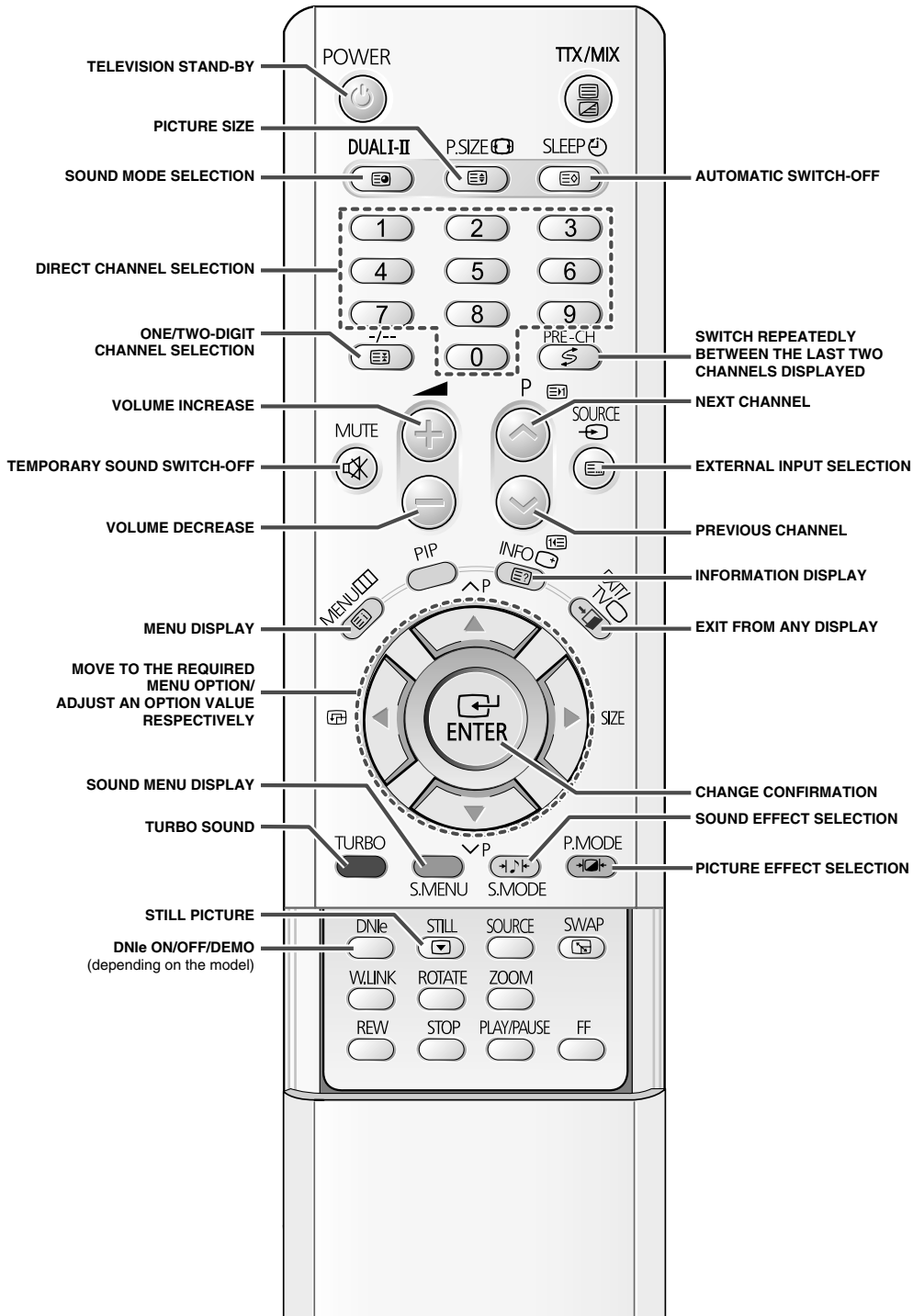

➤ The performance of the remote control may be affected by bright light.

Infrared Remote Control (continued)

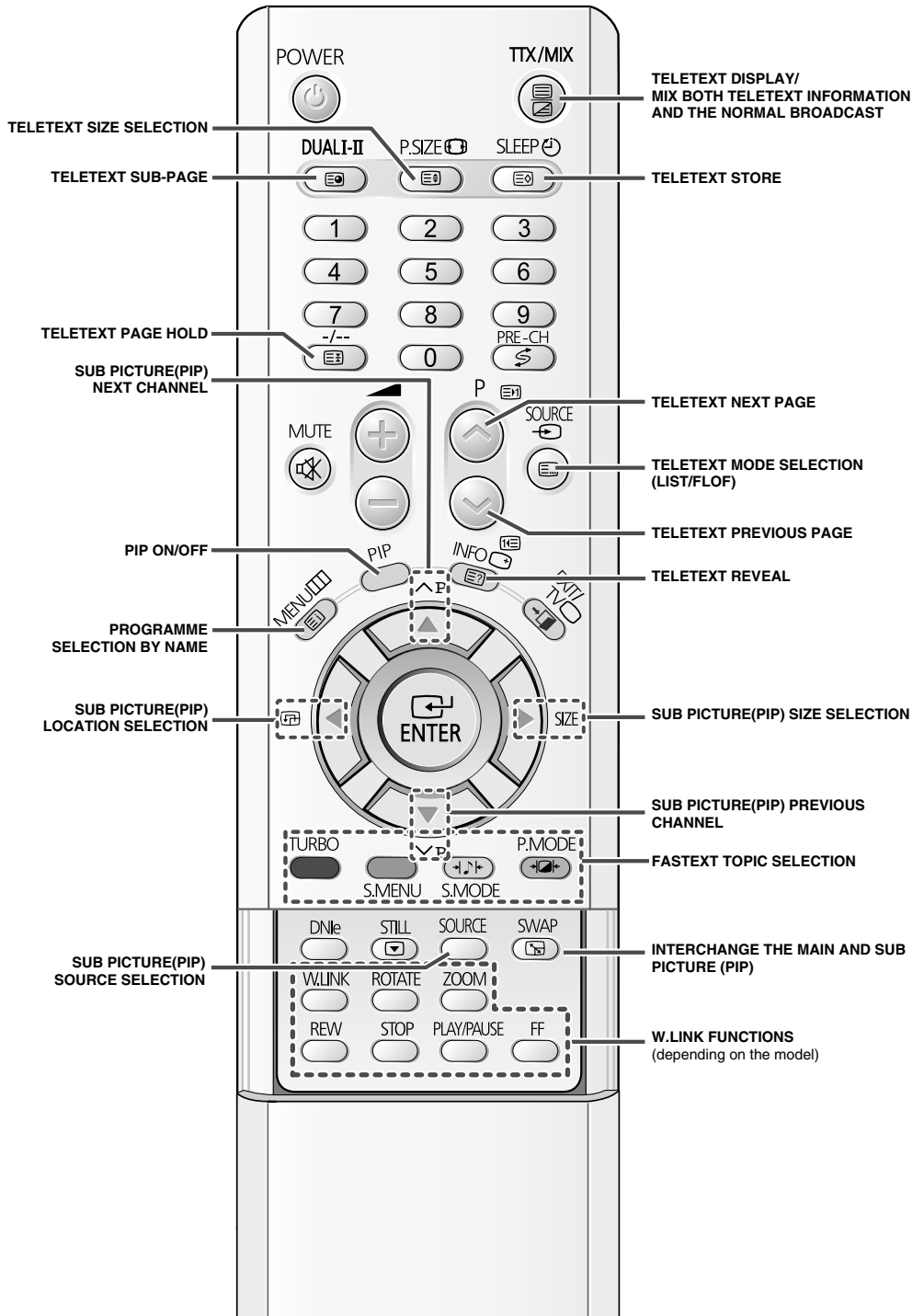

Inserting the Batteries in the Remote Control

You must insert or replace the batteries in the remote control when you:

- ◆ *Purchase the television*
- ◆ *Find that the remote control is no longer operating correctly*

- 1 Remove the cover on the rear of the remote control by pressing the symbol (▼) downwards and then pulling firmly to remove it.
- 2 Insert two R03, UM4, "AAA" 1.5V or equivalent batteries taking care to respect the polarities:
 - ◆ - on the battery against - on the remote control
 - ◆ + on the battery against + on the remote control
- 3 Replace the cover by aligning it with the base of the remote control and pressing it back into place.

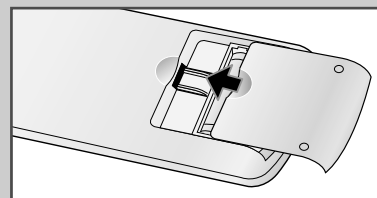
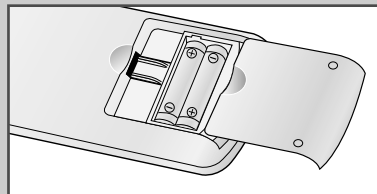
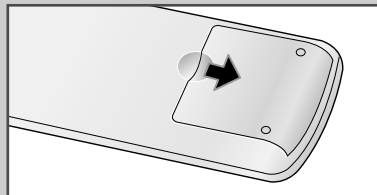

Connecting to an Aerial or Cable Television Network

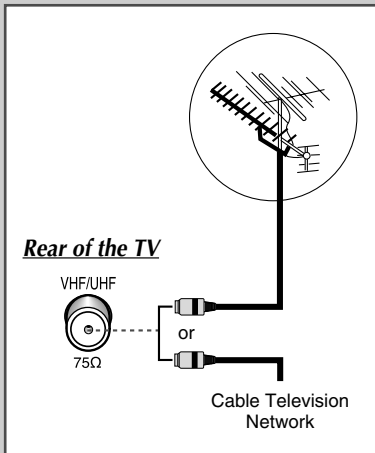

To view television channels correctly, a signal must be received by the set from one of the following sources:

- ◆ *An outdoor aerial*
- ◆ *A cable television network*
- ◆ *A satellite network*

1 In the first three cases, connect the aerial or network input cable to the 75Ω coaxial socket on the rear of the television.

2 If you are using an indoor aerial, you may need to turn it when tuning your television until you obtain a picture that is both sharp and clear.

For further details, refer to:

- ◆ "Storing Channels Automatically" on page 15
 - ◆ "Storing Channels Manually" on page 17
-

Switching Your Television On and Off

The mains lead is attached to the rear of your television.

- 1 Plug the mains lead into an appropriate socket.
 - The main voltage is indicated on the rear of the television and the frequency is 50 or 60Hz.
- 2 Press the “⏻” button (On/Off) on the front of the television.

Result: The Standby indicator on the front of the television lights up.
- 3 Press the **POWER** (⏻) button on the remote control to switch the television on.

Result: The programme that you were watching last is re-selected automatically.

 - If you have not yet stored any channels, No clear picture appears. Refer to “Storing Channels Automatically” on page 15 or “Storing Channels Manually” on page 17.
- 4 To switch your television off, press the “⏻” button (On/Off) again.

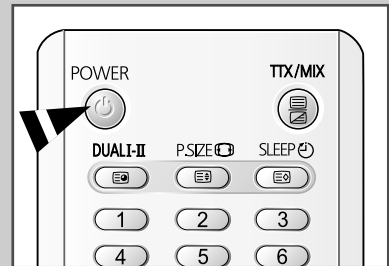

Placing Your Television in Standby Mode

Your television can be placed in Standby mode, in order to reduce:

- ◆ Power consumption
- ◆ Wear of the cathode ray tube

The Standby mode can be useful when you wish to interrupt viewing temporarily (during a meal, for example).

- 1 Press the **POWER** (⏻) button on the remote control.

Result: The screen is turned off and the Standby indicator on the front of the television lights up in red.
- 2 To switch the television back on, simply press the **POWER** (⏻) button again.
 - You can also switch on by pressing the **P** (⏻) or (⏻) button.

- 👉 Do not leave your television in Standby mode for long periods of time (when you are away on holiday, for example). Turn your television off by pressing the “⏻” button (On/Off) on the front of the television. It is best to unplug the set from the mains and aerial.

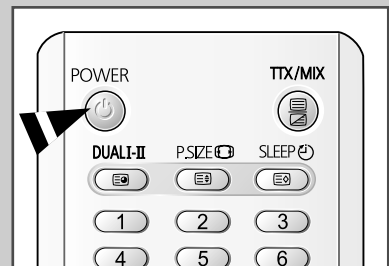

Becoming Familiar with the Remote Control

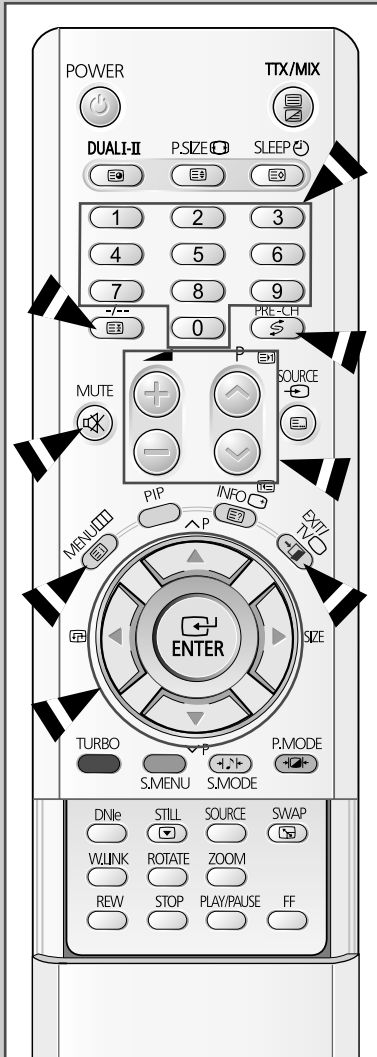

The remote control is used mainly to:

- ◆ Change channels and adjust the volume
- ◆ Set up the television using the on-screen menu system

The following table presents the most frequently used buttons and their functions.

Button	Viewing Function	Menu Function
	Used to display the next stored channel.	—
	Used to display the previous stored channel.	—
	Used to display the corresponding channels.	—
	Used to select a channel numbered ten or over. Press this button, and the "--" symbol is displayed. Enter the two-digit channel number.	—
PRE-CH	Press the PRE-CH button. The TV will switch to the last channel viewed. To quickly switch between two channels that are far apart, tune to one channel, then use the number button to select second channel. Then, use the PRE-CH button to quickly alternate between them.	—
	Used to increase the volume.	—
	Used to decrease the volume.	—
MUTE 	Used to switch the sound off temporarily. ➤ To turn the sound back on, press this button again, or press the or button.	—
MENU 	Used to display the on-screen menu system.	Used to return to the previous menu or normal viewing.
	—	Used to: ◆ Display a submenu containing selections for the current menu option ◆ Increase/decrease a menu option value
	—	Used to confirm your choice.
EXIT 	—	Used to exit from the menu system and return to normal viewing directly.
TV 	Used to switch the television on when it is in Standby mode.	—

Plug & Play Feature

When the television is initially powered on, three basic customer settings proceed automatically and subsequently: setting the language, channel and clock.

- 1 If the television is in Standby mode, press the **POWER** (⏻) button on the remote control.

Result: The message **Plug & Play** is displayed. It flickers for a little while and then **Language** menu is automatically displayed.

- 2 Select the appropriate language by pressing the ◀ or ▶ button. Press the **MENU** (☐☐☐) button to enter the language.

Result: The message **Check antenna input.** is displayed.

➤ If any language is not selected on the **Language** menu, the **Language** menu will disappear about 30 seconds later.

- 3 Make sure that the antenna is connected to the TV. Press the ◀ or ▶ button.

Result: The **Auto Store** menu is displayed with **Area** is selected.

- 4 Select your Area by pressing the ◀ or ▶ button. To search the channels, select **Search** by pressing the ▼ or ▲ button, and then press the ◀ or ▶ button. Press the **MENU** (☐☐☐) button to stop the search.

Result: The **Time** menu is displayed with **Clock** is selected.

➤ Refer to “Storing Channels Automatically” on page 15.

- 5 Press the ◀ or ▶ button to move to the hour or minute. Set the hour or minute by pressing the ▼ or ▲ button.

➤ Refer to “Setting and Displaying the Current Time” on page 33.

- 6 When you have finished, press the **MENU** (☐☐☐) button.

Result: The message **Enjoy your watching.** is displayed, and then the channel which has been stored will be activated.

- 7 **If you want to reset this feature...**

- 1 Press the **MENU** (☐☐☐) button.

- 2 Press the ▼ or ▲ button to select **Setup**, and then press the **ENTER** (↵) button.

Result: The **Plug & Play** is selected.

- 3 Press the **ENTER** (↵) button again.

Result: This feature starts with the message **Plug & Play** is displayed.

Plug & Play

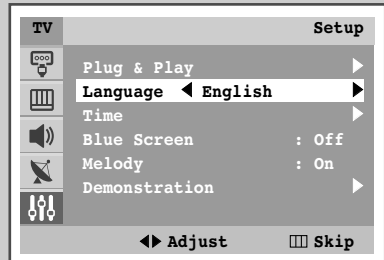

Check antenna input.

Move Skip

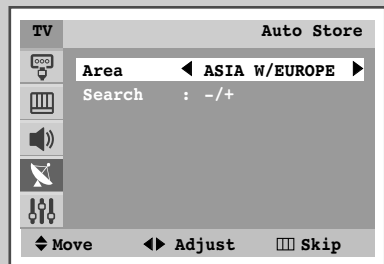

TV Time

Clock -- : -- am
Sleep Timer : Off
On Timer -- : -- am Off
Off Timer -- : -- am Off
On Timer Volume : 10
On Timer Channel : P 1

Move Adjust Skip

Enjoy your watching.

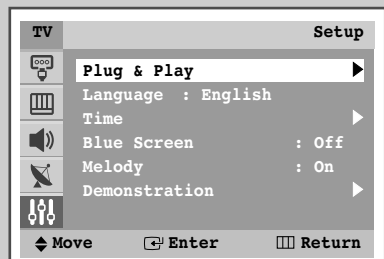

Viewing the Demonstration

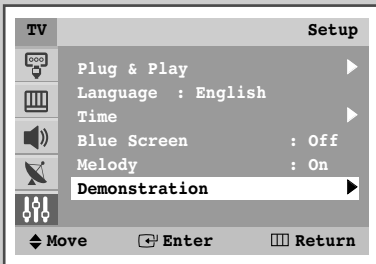
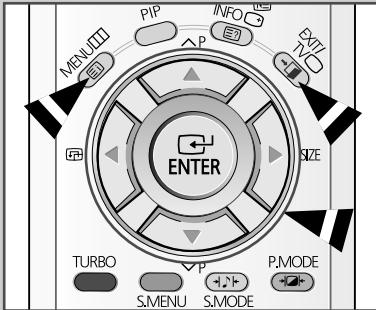

To become familiar with the various menus provided by your television, you can view the inbuilt demonstration.

- 1 Press the **MENU** (□□□) button.
Result: The main menu is displayed.
- 2 Press the ▼ or ▲ button to select **Setup**.
Result: The options available in the **Setup** group are displayed.
- 3 Press the **ENTER** (↵) button.
- 4 Press the ▼ or ▲ button to select **Demonstration**.
- 5 Press the **ENTER** (↵) button.
Result: Each of the menu options is displayed in turn.
➤ When you wish to exit from the demonstration, press the **EXIT** (→) button on the remote control.

Choosing Your Language

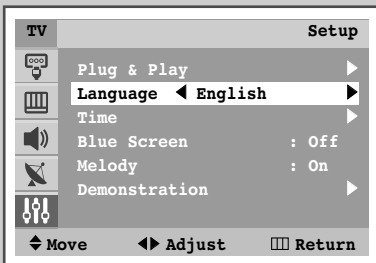

When you start using your television for the first time, you must select the language which will be used for displaying menus and indications.

- 1 Press the **MENU** (□□□) button.
Result: The main menu is displayed.
- 2 Press the ▼ or ▲ button to select **Setup**.
Result: The options available in the **Setup** group are displayed.
- 3 Press the **ENTER** (↵) button.
- 4 Press the ▼ or ▲ button to select **Language**.
- 5 Select the appropriate language by pressing the ◀ or ▶ button repeatedly.
- 6 When you have finished, press the **EXIT** (→) button to exit.

Storing Channels Automatically

You can scan for the frequency ranges available to you (and availability depends on your area). Automatically allocated programme numbers may not correspond to actual or desired programme numbers. However you can sort numbers manually and clear any channels you do not wish to watch.

- 1 Press the **MENU** (□□□) button.

Result: The main menu is displayed.

- 2 Press the ▼ or ▲ button to select **Channel**.

Result: The options available in the **Channel** group are displayed.

- 3 Press the **ENTER** (↵) button.

Result: The **Auto Store** is selected.

- 4 Press the **ENTER** (↵) button again.

Result: The options available in the **Auto Store** group are displayed with **Area** is selected.

- 5 Select your area by pressing the ◀ or ▶ button. The areas are displayed in the following order: **ASIA W/EUROPE - CIS E/EUROPE - CHINA - HONGKONG U/K - AUSTRALIA - NZ/INDONESIA - SOUTH AFRICA - AMERICA**

- 6 Press the ▼ or ▲ button to select **Search**.

- 7 Press the ◀ or ▶ button to start the search.

Result: The horizontal bar is displayed, and then channels are stored in an order which reflects their positions in the frequency range. Finally, the search will end automatically.

➤ To stop the search before it has finished, press the **MENU** (□□□) button.

- 8 When searching and storing are complete, the **Sort** menu is displayed.

- ◆ To sort the stored channels into the desired numerical order, go to Step 6 of the “Sorting the Stored Channels” procedure on page 16.
- ◆ To exit from the channel store function without sorting the channels, press the **MENU** (□□□) button repeatedly until the menus disappear.

- 9 When the channels have been stored, you can:

- ◆ Sort them in the order required (refer to page 16)
- ◆ Skip Unwanted Channels (refer to page 19)
- ◆ Assign a name to the stored channels (refer to page 20)
- ◆ Fine tune channel reception if necessary (refer to page 21)
- ◆ Activate the Digital Noise Reduction feature (refer to page 26)

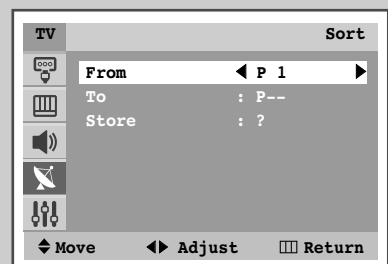
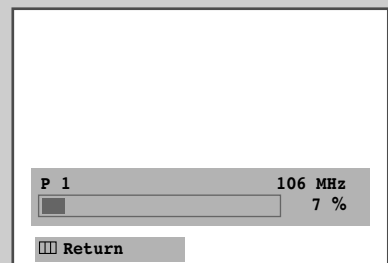
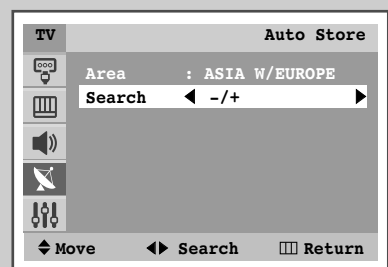
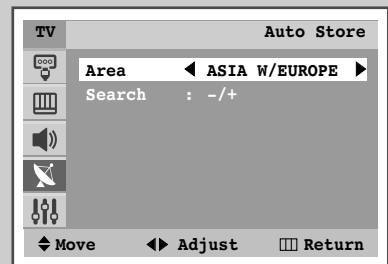
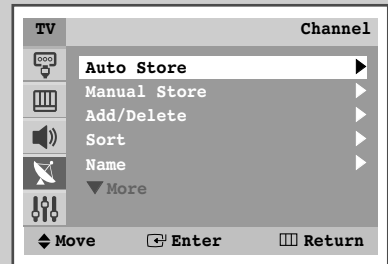

Sorting the Stored Channels

This operation allows you to change the programme numbers of stored channels. This operation may be necessary after using auto store. You can delete the channels you do not want to keep.

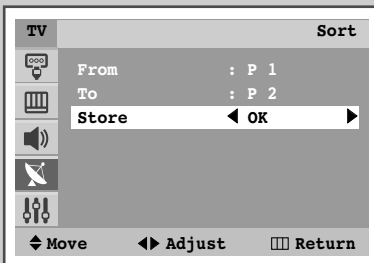
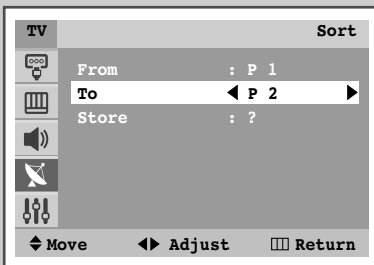
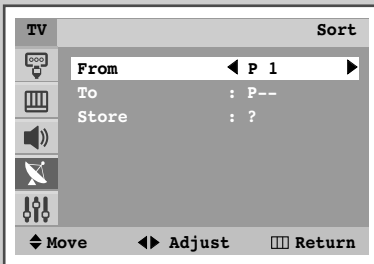
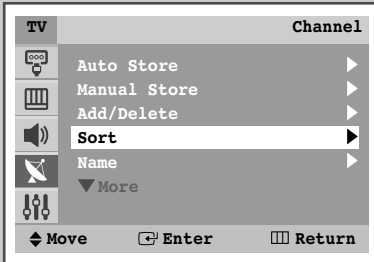

- 1 Press the **MENU** (□□□) button.

Result: The main menu is displayed.

- 2 Press the ▼ or ▲ button to select **Channel1**.

Result: The options available in the **Channel1** group are displayed.

- 3 Press the **ENTER** (↵) button.

- 4 Press the ▼ or ▲ button to select **Sort**.

- 5 Press the **ENTER** (↵) button.

Result: The options available in the **Sort** group are displayed with **From** is selected.

- 6 Select the channel number that you wish to change by pressing the ◀ or ▶ button repeatedly.

- 7 Press the ▼ or ▲ button to select **To**. Select the new channel number which you wish to identify by pressing the ◀ or ▶ button repeatedly.

➤ You can also select the channel number directly by pressing the numeric buttons (0~9).

- 8 Press the ▼ or ▲ button to select **Store**. Select **OK** to confirm the exchange of channel numbers by pressing the ◀ or ▶ button.

Result: The selected channel is exchanged with the one previously stored to the chosen number.

- 9 For all the channels to move to the required channel numbers, repeat steps 6 to 8 after selecting the **From** by pressing the ▼ or ▲ button.

- 10 When you have finished, press the **EXIT** (→□) button to exit.

Storing Channels Manually

You can store up to 100 television channels, including those received via cable networks.

When storing channels manually, you can choose:

- ◆ Whether or not to store each of the channels found
- ◆ The programme number of each stored channel which you wish to identify

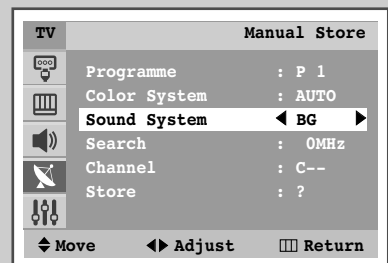
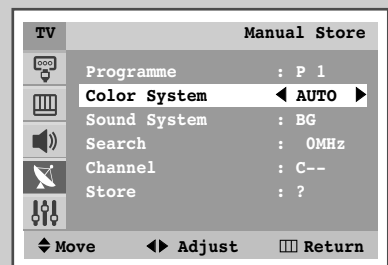
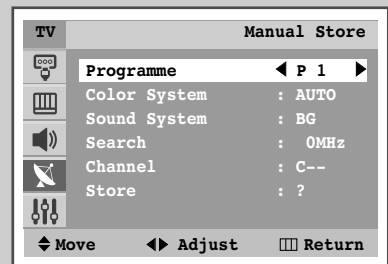
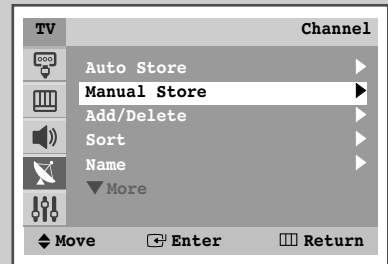

- 1 Press the **MENU** (□□□) button.
Result: The main menu is displayed.
- 2 Press the ▼ or ▲ button to select **Channel**.
Result: The options available in the **Channel** group are displayed.
- 3 Press the **ENTER** (↵) button.
- 4 Press the ▼ or ▲ button to select **Manual Store**.
- 5 Press the **ENTER** (↵) button.
Result: The options available in the **Manual Store** group are displayed with **Programme** is selected.
- 6 To assign a programme number to a channel, press the ◀ or ▶ button.
- 7 Press the ▼ or ▲ button to select **Color System**. Indicate the broadcasting standard required by pressing the ◀ or ▶ button repeatedly.
Result: The color standards are displayed in the following order:
AUTO - PAL - SECAM - NT4.43 - NT3.58.
- 8 Press the ▼ or ▲ button to select **Sound System**. Select the sound standard required by pressing the ◀ or ▶ button repeatedly.
Result: The sound standards are displayed in the following order:
BG - DK - I - M.

Storing Channels Manually (continued)

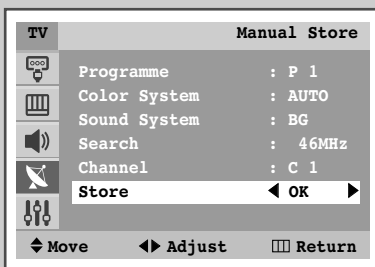
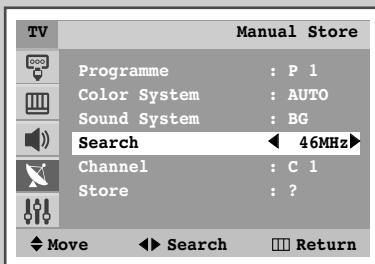
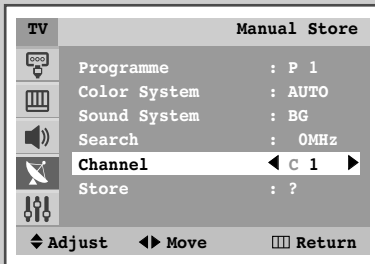

- 9 If you know the number of the channel to be stored, see the following steps.
 - ◆ Press the ▼ or ▲ button to select **Channel**.
 - ◆ Press the ► button.
 - ◆ Press the ▼ or ▲ button to select **C** (Air channel) or **S** (Cable channel).
 - ◆ Press the ► button.
 - ◆ Press the ▼ or ▲ button to select indicate the required number.
 - You can also select the channel number directly by pressing the numeric buttons (0~9).
 - If no sound or abnormal sound, re-select the sound system required.
- 10 If you do not know the channel numbers, select **Search** by pressing the ▼ or ▲ button. Press the ◀ or ▶ button to start the search.

Result: The tuner scans the frequency range until the first channel or the channel that you selected is received on your screen.
- 11 To store the channel and associated programme number, select **Store** by pressing the ▼ or ▲ button. Press the ◀ or ▶ button to select **OK**.
- 12 Repeat Steps 9 to 11 for each channel to be stored.
- 13 When you have finished, press the **EXIT** (→) button to exit.

Channel mode

- ◆ **P** (Programme mode): When completing tuning, the broadcasting stations in your area have been assigned to position numbers from P00 to max P99. You can select a channel by entering the position number in this mode.
- ◆ **C** (Real channel mode): You can select a channel by entering the assigned number to each air broadcasting station in this mode.
- ◆ **S** (Cable channel mode): You can select a channel by entering the assigned number for each cable channel in this mode.

Skipping Unwanted Channels

You can exclude the channels you chosen from the channels you scanned. When you scan through the stored channels, those you have chosen to skip are not displayed.

All of the channels that you do not specifically choose to skip are displayed during scanning.

- 1 Press the **MENU** (□□□) button.

Result: The main menu is displayed.

- 2 Press the ▼ or ▲ button to select **Channel**.

Result: The options available in the **Channel** group are displayed.

- 3 Press the **ENTER** (↵) button.

- 4 Press the ▼ or ▲ button to select **Add/Delete**.

- 5 Press the **ENTER** (↵) button.

Result: The stored channels are displayed.

- 6 Press the ▼ or ▲ button to select the channel to add or erase. If necessary, select **Added** or **Deleted** by pressing the ◀ or ▶ button.

- 7 Repeat Step 6 for each channel to be added or erased.

- 8 When you have finished, press the **EXIT** (→[]) button to exit.

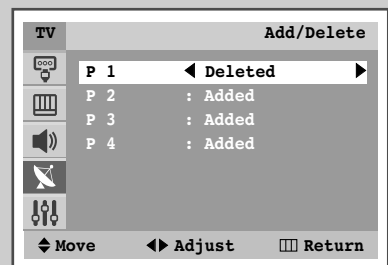
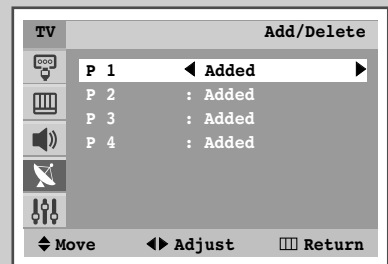
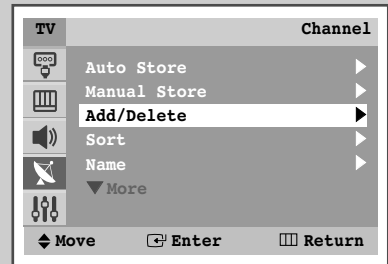

Assigning Names to Channels

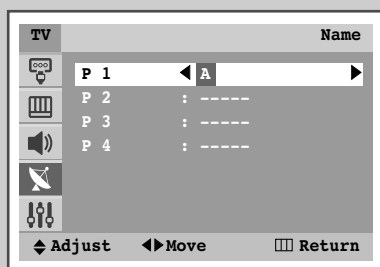
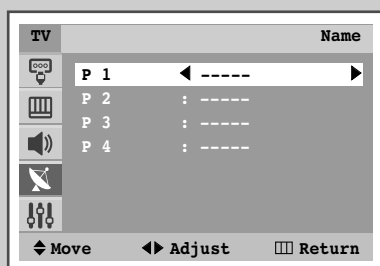
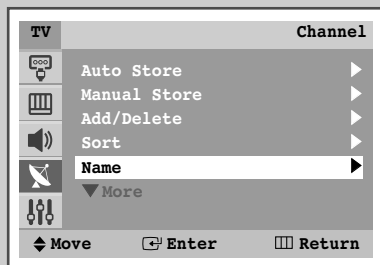

Channel names will be assigned automatically when channel information is broadcast. These names can be changed, allowing you to assign new names.

- 1 Press the **MENU** (□) button.

Result: The main menu is displayed.

- 2 Press the **▼** or **▲** button to select **Channel1**.

Result: The options available in the **Channel1** group are displayed.

- 3 Press the **ENTER** (↵) button.

- 4 Press the **▼** or **▲** button to select **Name**.

- 5 Press the **ENTER** (↵) button.

Result: The current channels are displayed.

- 6 If necessary, select the channel to be assigned to a new name by pressing the **▼** or **▲** button.

- 7 Press the **ENTER** (↵) button.

- 8 Press the **▼** or **▲** button to select a letter (A~Z), a number (0~9) or a symbol (-, space). Move on the previous or next letter by pressing the **◀** or **▶** button.

- 9 Repeat Steps **6** to **8** for each channel to be assigned to a new name.

- 10 When you have finished, press the **EXIT** (→) button to exit.

Fine Tuning Channel Reception

If the reception is clear, you do not have to fine tune the channel, as this is done automatically during the search and store operation. If the signal is weak or distorted, you may have to fine tune the channel manually.

- 1 Press the **MENU** (□□) button.
Result: The main menu is displayed.
- 2 Press the ▼ or ▲ button to select **Channel**.
Result: The options available in the **Channel** group are displayed.
- 3 Press the **ENTER** (↵) button.
- 4 Press the ▼ or ▲ button to select **Fine Tune**.
- 5 Press the **ENTER** (↵) button.
- 6 To obtain a sharp and clear picture and good sound quality, press the ◀ or ▶ button.
Result: The horizontal bar is displayed. Move the horizontal bar's cursor left or right by pressing the ◀ or ▶ button.
- 7 To store the fine tuning setting in the TV's memory, press the **ENTER** (↵) button.
Result: Channel indicator turns into Red.
- 8 To erase adjusted picture or sound, select **Reset** by pressing the ▼ or ▲ button. Press the **ENTER** (↵) button.
Result: Channel indicator returns to its original color.
- 9 When you have finished, press the **EXIT** (→) button to exit.

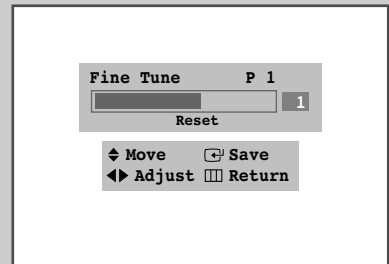
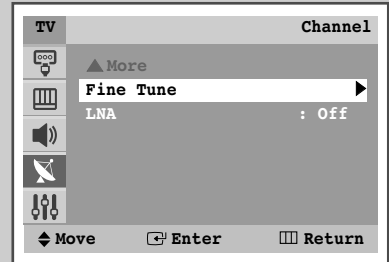

Using the LNA (Low Noise Amplifier) feature (depending on the model)

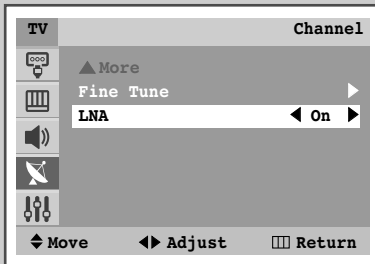

This function is very useful in the situation that the TV is used in weak signal. LNA amplifies the TV signal in the weak signal area, but not noise. This feature is working only weak signal condition, and that is memorized on current channel, additional.

- 1 Press the **MENU** (□□□) button.
Result: The main menu is displayed.
- 2 Press the ▼ or ▲ button to select **Channel1**.
Result: The options available in the **Channel1** group are displayed.
- 3 Press the **ENTER** (↵) button.
- 4 Press the ▼ or ▲ button to select **LNA**.
- 5 To activate this feature, select **On** by pressing the ◀ or ▶ button.
- 6 When you have finished, press the **EXIT** (→|) button to exit.

➤ Setting the LNA option to “On” may produce worse picture quality due to the current channel’s signal condition. Hence, apply LNA On/Off selectively according to the picture quality that is currently displayed.

Changing the Picture Standard

You can select the type of picture which best corresponds to your viewing requirements.

- 1 Press the **MENU** (□□□) button.
Result: The main menu is displayed.
- 2 Press the ▼ or ▲ button to select **Picture**.
Result: The options available in the **Picture** group are displayed.
- 3 Press the **ENTER** (↵) button.
Result: The **Mode** is selected.
- 4 Select the required picture effect by pressing the ◀ or ▶ button repeatedly.
Result: The following picture effects are available:
Dynamic – Standard – Movie – Custom.
- 5 When you have finished, press the **EXIT** (→|) button to exit.

➤ You can also set these options simply by pressing the **P.MODE**(+|↵) (Picture Mode) button.

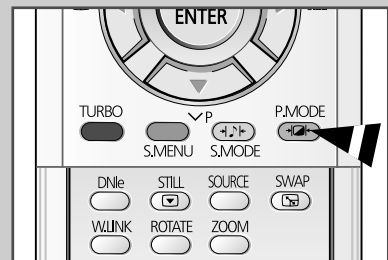
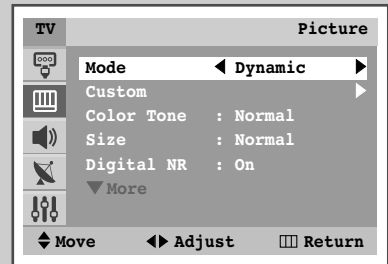

Adjusting the Picture Settings

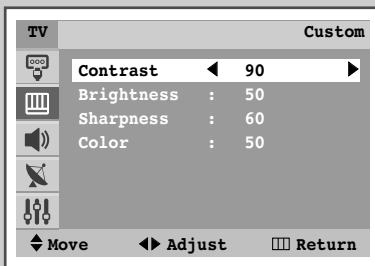
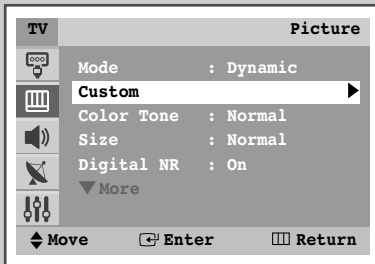

Your television has several settings which allow you to control picture quality.

- 1 Press the **MENU** (□□□) button.
Result: The main menu is displayed.
- 2 Press the ▼ or ▲ button to select **Picture**.
Result: The options available in the **Picture** group are displayed.
- 3 Press the **ENTER** (↵) button.
- 4 Press the ▼ or ▲ button to select **Custom**.
- 5 Press the **ENTER** (↵) button.
Result: The options available in the **Custom** group are displayed.
- 6 Press the ▼ or ▲ button to select the option (**Contrast**, **Brightness**, **Sharpness**, **Color** or **Tint-NTSC** only) to be adjusted. Press the ◀ or ▶ button.
Result: The horizontal bar is displayed. Move the horizontal bar's cursor left or right by pressing the ◀ or ▶ button.
- 7 When you have finished, press the **EXIT** (→) button to exit.

-
- ◆ If you make any changes to these settings, the picture standard is automatically switched to **Custom**.
 - ◆ The television has an "automatic degaussing" system that is activated if magnetic interference is present. To degauss the television screen, switch power off by pressing the "Ⓞ" (On/Off) button on the front panel. (Refer to "Automatic Degaussing to Remove Color Patches" on page 48.)

Selecting the Color Tone

- 1 Press the **MENU** (□□□) button.
Result: The main menu is displayed.
- 2 Press the ▼ or ▲ button to select **Picture**.
Result: The options available in the **Picture** group are displayed.
- 3 Press the **ENTER** (↵) button.
- 4 Press the ▼ or ▲ button to select **Color Tone**.
- 5 Press the ◀ or ▶ button.
Result: The horizontal bar is displayed. Move the horizontal bar's cursor left or right by pressing the ◀ or ▶ button. (Warm1 ~ Warm10 - Normal - Cool1 ~ Cool10).
- 6 When you have finished, press the **EXIT** (→) button to exit.

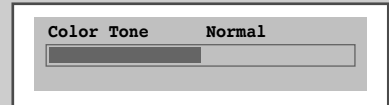
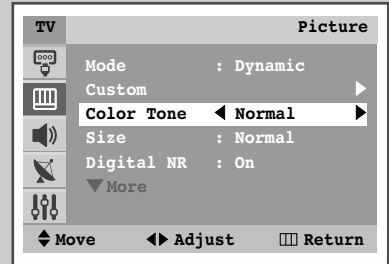

Selecting the Picture Size (depending on the model)

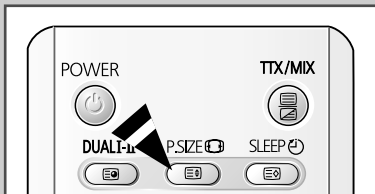
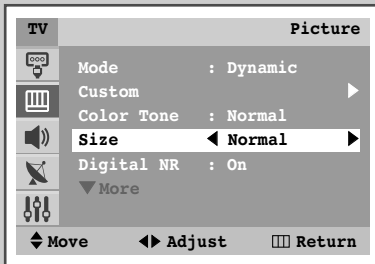

You can select the picture size which best corresponds to your viewing requirements simply by pressing the "P.SIZE (P.SIZE)" button. Depending on the model, the following picture sizes are available:

- ◆ Normal, Zoom1, Zoom2, 16:9
- ◆ 16:9, Panorama, Zoom1, Zoom2, 4:3

- 1 Press the **MENU** (P.SIZE) button.
Result: The main menu is displayed.
- 2 Press the ▼ or ▲ button to select **Picture**.
Result: The options available in the **Picture** group are displayed.
- 3 Press the **ENTER** (P.SIZE) button.
- 4 Press the ▼ or ▲ button to select **Size**.
- 5 Press the ◀ or ▶ button to select the picture size.
- 6 When you have finished, press the **EXIT** (P.SIZE) button to exit.

Selecting the Digital NR

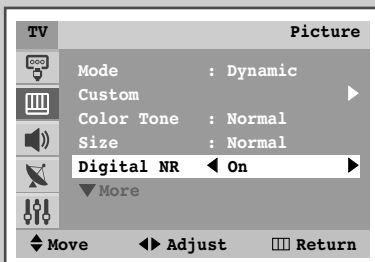

If the signal received by your television is weak, you can activate this feature to reduce any static and ghosting that may appear on the screen.

- 1 Press the **MENU** (P.SIZE) button.
Result: The main menu is displayed.
- 2 Press the ▼ or ▲ button to select **Picture**.
Result: The options available in the **Picture** group are displayed.
- 3 Press the **ENTER** (P.SIZE) button.
- 4 Press the ▼ or ▲ button to select **Digital NR**.
- 5 To activate this feature, select **On** by pressing the ◀ or ▶ button.
- 6 When you have finished, press the **EXIT** (P.SIZE) button to exit.

Using the Tilt Control Feature

If you find that the picture received is slightly tilted to one side, you can adjust the tilt setting.

- 1 Press the **MENU** (□□□) button.
Result: The main menu is displayed.
- 2 Press the ▼ or ▲ button to select **Picture**.
Result: The options available in the **Picture** group are displayed.
- 3 Press the **ENTER** (↵) button.
- 4 Press the ▼ or ▲ button to select **Tilt**.
- 5 Press the ◀ or ▶ button to reach the required setting (-7 to +7).
- 6 When you have finished, press the **EXIT** (→□) button to exit.

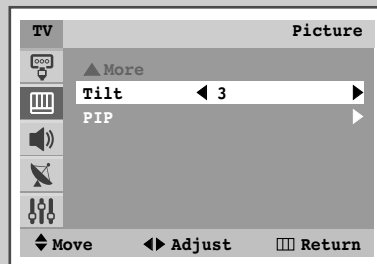

Setting the Blue Screen

If no signal is being received or the signal is very weak, a blue screen automatically replaces the noisy picture background.

If you wish to continue viewing the poor picture, you must set the "Blue Screen" mode to "Off".

- 1 Press the **MENU** (□□□) button.
Result: The main menu is displayed.
- 2 Press the ▼ or ▲ button to select **Setup**.
Result: The options available in the **Setup** group are displayed.
- 3 Press the **ENTER** (↵) button.
- 4 Press the ▼ or ▲ button to select **Blue Screen**.
- 5 To activate this feature, select **On** by pressing the ◀ or ▶ button.
- 6 When you have finished, press the **EXIT** (→□) button to exit.

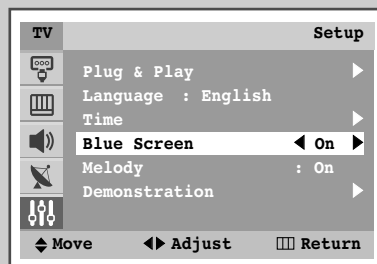

Freezing the Current Picture

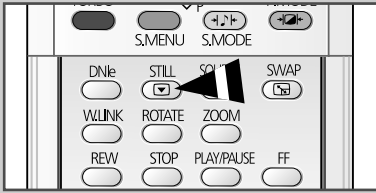

You can freeze the picture when watching a television programme simply by pressing the “STILL (▼)” button.

➤ To return to normal viewing, press this button again.

Changing the Sound Standard

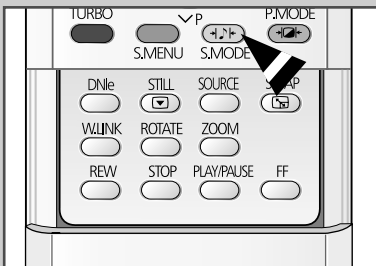
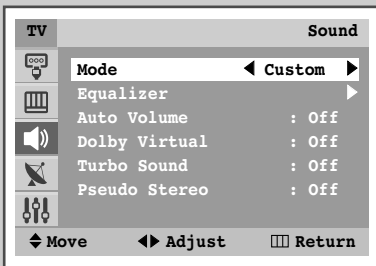

You can select the type of special sound effect to be used when watching a given broadcast.

- 1 Press the **MENU** (□□□) button.
Result: The main menu is displayed.

- 2 Press the ▼ or ▲ button to select **Sound**.
Result: The options available in the **Sound** group are displayed.

- 3 Press the **ENTER** (↵) button.
Result: The **Mode** is selected.

- 4 Select the required sound effect by pressing the ◀ or ▶ button repeatedly.
Result: The following sound effects are available:
Standard - Music - Movie - Speech(SVE) - Custom.
◆ **SVE** : **S**AMSUNG **V**oice **E**nhancement **T**echnic

- 5 When you have finished, press the **EXIT** (→□) button to exit.

➤ You can also set these options simply by pressing the **S.MODE**(↵) (Sound Mode) button.

Adjusting the Sound Settings

The sound settings can be adjusted to suit your personal preferences.

- 1 Press the **MENU** (□□□) button.
Result: The main menu is displayed.
- 2 Press the ▼ or ▲ button to select **Sound**.
Result: The options available in the **Sound**. group are displayed.
- 3 Press the **ENTER** (↵) button.
- 4 Press the ▼ or ▲ button to select **Equalizer**.
- 5 Press the **ENTER** (↵) button.
Result: The options available in the **Equalizer** group are displayed.
➤ You can also display this group simply by pressing the **S.MENU** (Sound Menu) button.
- 6 Select the option to be adjusted by pressing the ◀ or ▶ button. Press the ▼ or ▲ button to reach the required setting.
- 7 When you have finished, press the **EXIT** (→|) button to exit.

➤ If you make any changes to these settings, the sound standard is automatically switched to **Custom**.

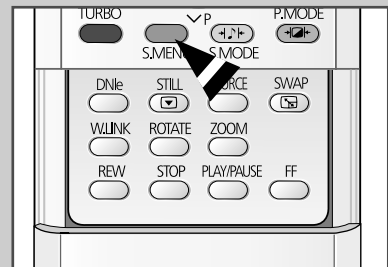
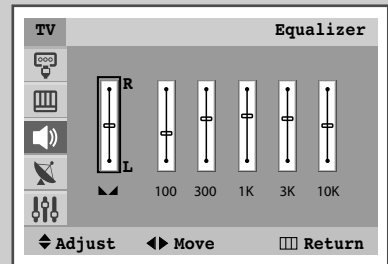
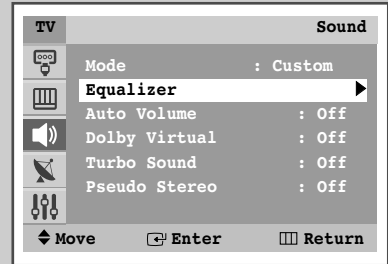

Extra Sound Settings (depending on the model)

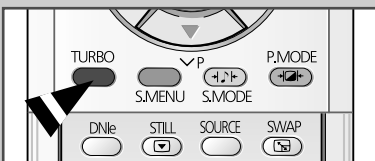
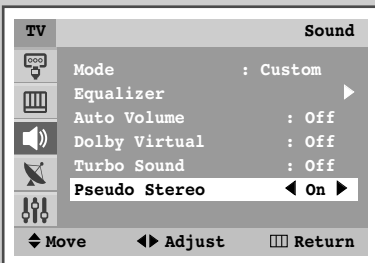
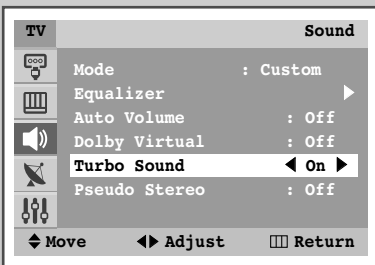
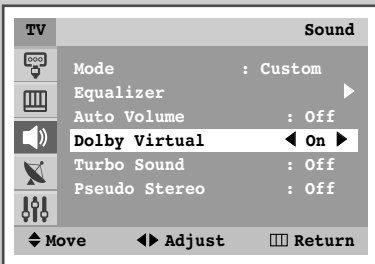
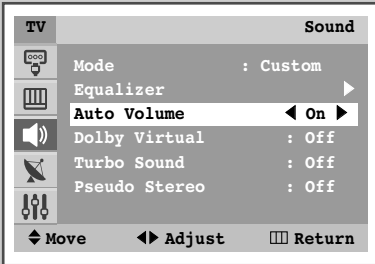

◆ **Auto Volume**

Each broadcasting station has its own signal conditions, and so it is not easy for you to adjust the volume every time the channel is changed. This feature lets you automatically adjust the volume of the desired channel by lowering the sound output when the modulation signal is high or by raising the sound output when the modulation signal is low.

◆ **Turbo Sound**

This feature suitably emphasizes both higher and lower bands of sound (and includes other effects).

You can enjoy more magnificent and dynamic sound when watching music, movie, or other channels.

◆ **Pseudo Stereo / Dolby Virtual**

Pseudo stereo feature converts a monaural sound signal into two identical left and right channels.

Once the **Pseudo Stereo** or **Dolby Virtual** is set to **On** or **Off**, these settings apply to the sound effects such as **Standard, Music, Movie, and Speech (SVE)**.

- 1 Press the **MENU** (□□□) button.

Result: The main menu is displayed.

- 2 Press the ▼ or ▲ button to select **Sound**.

Result: The options available in the **Sound** group are displayed.

- 3 Press the **ENTER** (↵) button.

- 4 Select the required option (**Auto Volume, Dolby Virtual, Turbo Sound** or **Pseudo Stereo**) by pressing the ▼ or ▲ button.

➤ You can select the turbo sound feature simply by pressing the **TURBO** button.

- 5 To activate each feature, select **On** by pressing the ◀ or ▶ button.

- 6 When you have finished, press the **EXIT** (→□) button to exit.

➤ Manufactured under license from Dolby Laboratories. “Dolby” and the double-D symbol are trademarks of Dolby Laboratories.



Selecting the Melody

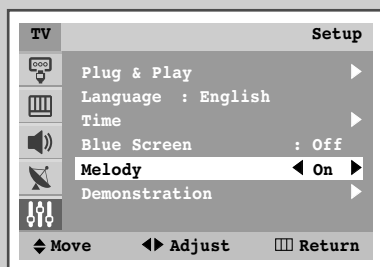

You can hear clear melody sound when the television is powered on or off.

-
- 1 Press the **MENU** (□□□) button.
Result: The main menu is displayed.

 - 2 Press the ▼ or ▲ button to select **Setup**.
Result: The options available in the **Setup** group are displayed.

 - 3 Press the **ENTER** (↵) button.

 - 4 Press the ▼ or ▲ button to select **Melody**.

 - 5 To activate this feature, select **On** by pressing the ◀ or ▶ button.

 - 6 When you have finished, press the **EXIT** (→□) button to exit.
-

Setting and Displaying the Current Time

You can set the television's clock so that the current time is displayed by pressing the "INFO ()" button. You must also set the time if you wish to use the automatic on or off timers.

- When pressing the "Ⓜ" button (On/Off) on the front of the television, the clock setting will be reset.

1 Press the **MENU** () button.

Result: The main menu is displayed.

2 Press the ▼ or ▲ button to select **Setup**.

Result: The options available in the **Setup** group are displayed.

3 Press the **ENTER** () button.

4 Press the ▼ or ▲ button to select **Time**.

5 Press the **ENTER** () button.

Result: The **Clock** is selected.

6 Press the ◀ or ▶ button to move to the hour or minute. Set the hour or minute by pressing the ▼ or ▲ button.

7 When you have finished, press the **EXIT** () button to exit.

8 Press the **INFO** () button to display the channel information and the current time.

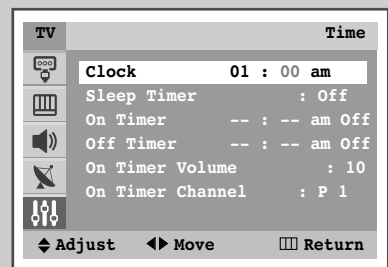
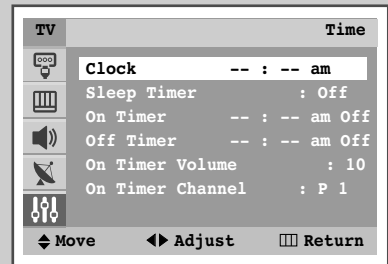
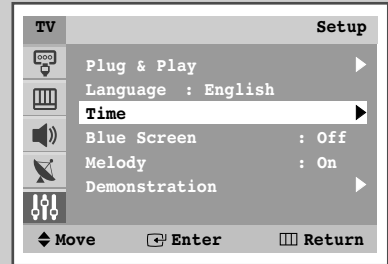

Setting the Sleep Timer

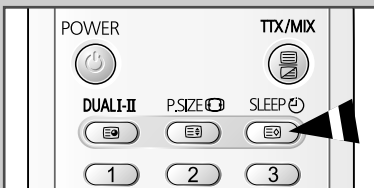
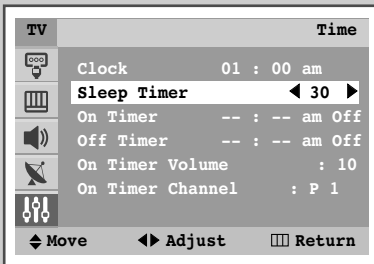
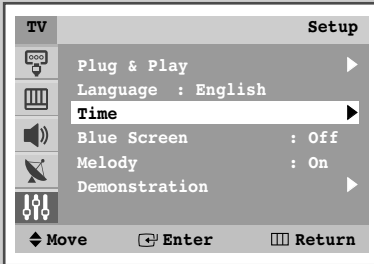

You can set your TV to automatically turn off after a preset interval.

- 1 Press the **MENU** (□□□) button.
Result: The main menu is displayed.

- 2 Press the ▼ or ▲ button to select **Setup**.
Result: The options available in the **Setup** group are displayed.

- 3 Press the **ENTER** (↵) button.

- 4 Press the ▼ or ▲ button to select **Time**.

- 5 Press the **ENTER** (↵) button.
Result: The **Clock** is selected.

- 6 Press the ▼ or ▲ button to select **Sleep Timer**.

- 7 Select the preset time interval (Off, 30, 60, 90, 120, 150, 180) for staying on by pressing the ◀ or ▶ button.

- 8 When you have finished, press the **EXIT** (→|) button to exit.

➤ You can select a time period of between 30 and 180 minutes after the television automatically switches to Standby mode by pressing the **SLEEP** (⌚) button.

Switching the Television On and Off Automatically

You can set the On/Off timers so that the television will:

- ◆ Switch on automatically and tune to the channel of your choice at the time you select
- ◆ Switch off automatically at the time you select

➤ The first step is to set the television's clock (refer to "Setting and Displaying the Current Time" on the page 33). If you have not yet set the clock, the message **Set the clock first** is displayed.

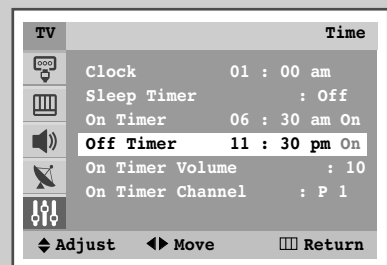
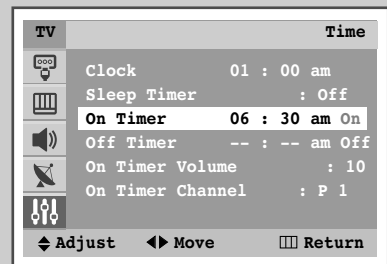
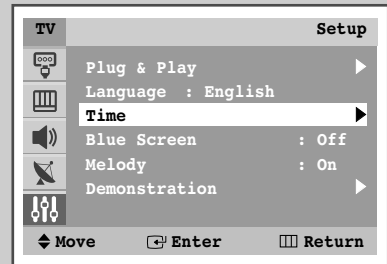

- 1 Press the **MENU** (□□□) button.
Result: The main menu is displayed.
- 2 Press the ▼ or ▲ button to select **Setup**.
Result: The options available in the **Setup** group are displayed.
- 3 Press the **ENTER** (↵) button.
- 4 Press the ▼ or ▲ button to select **Time**.
- 5 Press the **ENTER** (↵) button.
Result: The **Clock** is selected.
- 6 Press the ▼ or ▲ button to select **On Timer**. Set the time at which you wish the television to be switched on automatically.
 - ◆ Press the ◀ or ▶ button to move to the hour or minute. Set these by pressing the ▼ or ▲ button.
 - ◆ Press the ◀ or ▶ button to move **Off** and then, press the ▼ or ▲ button to select **On**.
- 7 Press the ▼ or ▲ button to select **Off Timer**. In the same above, set the time at which you wish the television to be switched off automatically.
- 8 When you have finished, press the **EXIT** (→□) button to exit.

➤ Auto Power Off

When you set the timer "On", the television will eventually turn off, if no controls are operated for 3 hours after the TV was turned on by timer. This function is only available in timer "On" mode and prevents overheating or leakages, which may occur if a TV is on for too long (on holiday, for example).

Setting the Preferred Volume Level/Channel

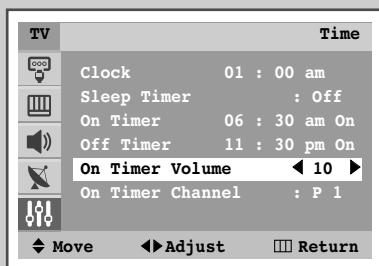
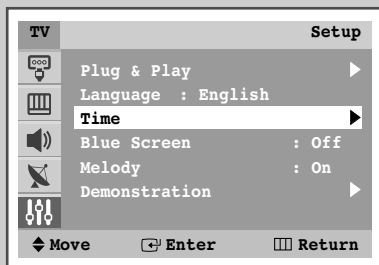

The preferred volume and channel can be set for when the timer automatically turns on the TV.

- 1 Press the **MENU** (□□□) button.
Result: The main menu is displayed.
- 2 Press the ▼ or ▲ button to select **Setup**.
Result: The options available in the **Setup** group are displayed.
- 3 Press the **ENTER** (↵) button.
- 4 Press the ▼ or ▲ button to select **Time**
- 5 Press the **ENTER** (↵) button.
Result: The **Clock** is selected.
- 6 Press the ▼ or ▲ button to select **On Timer Volume**.
- 7 Press the ◀ or ▶ button to adjust volume level.
- 8 Press the ▼ or ▲ button to select **On Timer Channel**.
- 9 Press the ◀ or ▶ button to select the channel.
- 10 When you have finished, press the **EXIT** (→) button.

Viewing an External Signal Source/Edit Name (depending on the model)

Use the remote control to switch between viewing signal from connected equipment, such as VCR, DVD, Set-Top-boxes and the TV source (broadcast or cable)

- 1 Press the **MENU** () button.

Result: The main menu is displayed.

- 2 Press the **ENTER** () button to select **Input**.

Result: The options available in the **Input** group are displayed.

- 3 Press the **ENTER** () button again to select **Source List**.

Result: The options available in the **Source List** group are displayed.

- 4 Press the **▼** or **▲** button to select signal source, then press the **ENTER** () button.

➤ When you connect equipment to the TV, you can choose between the following sets of jacks : **AV1**, **AV2**, **AV3**, **Component1** or **Component2** on the TV's rear panel, and **AV4/S-Video** on the TV's side panel.

➤ You can also set these options simply by pressing the **SOURCE** () button. If you change the external source while viewing, pictures might take a short period of time to be switched.

Edit Name

- 1 Press the **MENU** () button.

Result: The main menu is displayed.

- 2 Press the **ENTER** () button to select **Input**.

Result: The options available in the **Input** group are displayed.

- 3 Press the **▼** or **▲** button to select **Edit Name**. Press the **ENTER** () button.

Result: The options available in the **Edit Name** group are displayed.

- 4 Press the **▼** or **▲** button to select external device : **AV1 – AV2 – AV3 – AV4 – S-Video – Component1 – Component2**.

- 5 Press the **ENTER** () button.

- 6 Select the name by pressing the **◀** or **▶** button.

- 7 Set other signal sources (**AV1 – AV2 – AV3 – AV4 – S-Video – Component1 – Component2**) using the same method as listed above.

- 8 When you have finished, press the **EXIT** () button to exit.

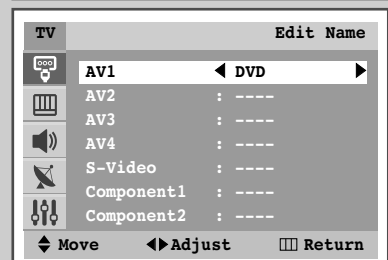
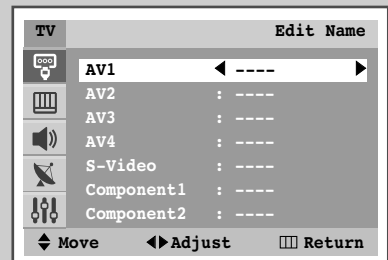
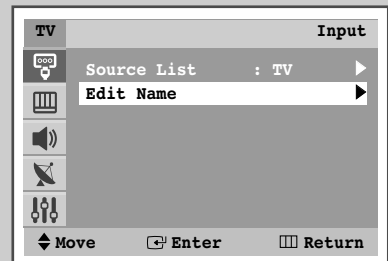
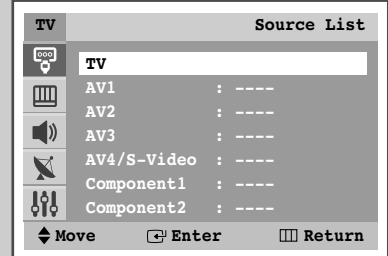
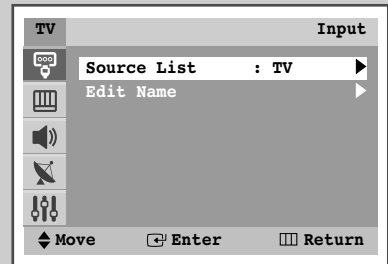

Viewing the Picture In Picture (PIP) (depending on the model)

You can display a sub picture within the main picture of TV program or external A/V devices such as VCR or DVD. In this way you can watch TV program or monitor the video input from any connected devices while watching TV or other video input.

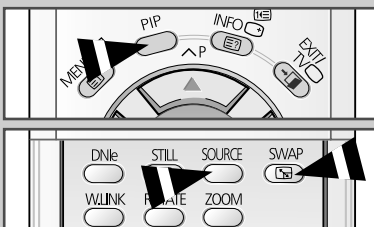
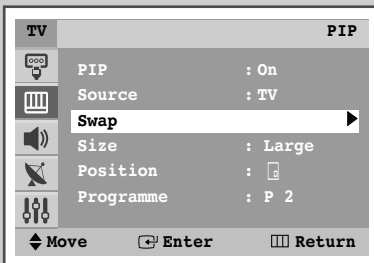
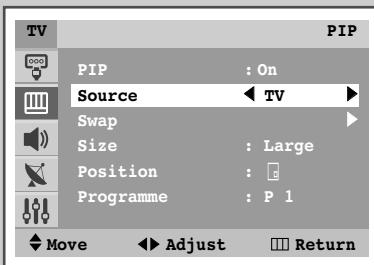
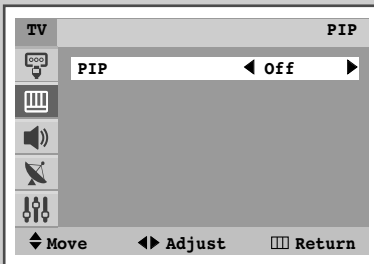
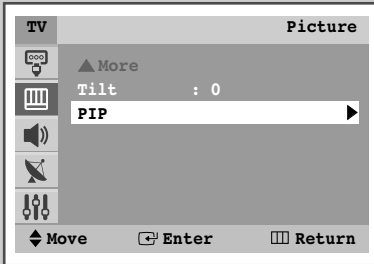

- 1 Press the **MENU** () button.
Result: The main menu is displayed.

- 2 Press the **▼** or **▲** button to select **Picture**.
Result: The options available in the **Picture** group are displayed.

- 3 Press the **ENTER** () button.

- 4 Press the **▼** or **▲** button to select **PIP**. Press the **ENTER** () button.

- 5 Press the **◀** or **▶** button to **On**.
Result: The options available in the **PIP** group are displayed.
➤ You can also activate the PIP simply by pressing the **PIP** button. To deactivate, press it again.

- 6 Press the **▼** or **▲** button to select **Source**.

- 7 Press the **◀** or **▶** button to select a source of sub picture.
Result: The sources are displayed in the following order:
TV – AV1 – AV2 – AV3 – AV4/S-Video
➤ When viewing **Component1** or **Component2** as the main picture, **PIP** will not work. You cannot view **Component1** or **Component2** in the sub-picture within the PIP screen.

Mode	PIP							
	TV	AV1	AV2	AV3	AV4	S-Video	Component1	Component2
TV	O	O	O	O	O	O	X	X
AV1	O	O	O	O	O	O	X	X
AV2	O	O	O	O	O	O	X	X
AV3	O	O	O	O	O	O	X	X
AV4	O	O	O	O	O	O	X	X
S-Video	O	O	O	O	O	O	X	X
Component1	X	X	X	X	X	X	X	X
Component2	X	X	X	X	X	X	X	X

- 8 Press the **▼** or **▲** button to select **Swap**.

- 9 Press the **ENTER** () button.
Result: The main picture and the sub picture are interchanged.
➤ You can also interchange the main picture and the sub picture simply by pressing the **SWAP** button.

Viewing the Picture In Picture (PIP) (depending on the model) (continued)

10 Press the ▼ or ▲ button to select **Size**.

11 Select a size of sub picture by pressing the ◀ or ▶ button.

Result: The sizes are displayed in the following order:

Small – 3PIP – 4PIP – 12PIP – Large

3PIP/4PIP/12PIP : You can view up to 3,4, or 12 memorizer channels on the sub picture spontaneously.

➤ You can select these options simply by pressing the **SIZE** button.

12 Press the ▼ or ▲ button to select **Position**.

13 Press the ◀ or ▶ button.

Result: The positions are displayed.

□ – □ – □ – □

➤ Anda dapat menentukan pilihan tersebut cukup dengan menekan tombol **Position** (□).

14 Press the ▼ or ▲ button to select **Programme**. You can select the channel that you want to view through sub picture by pressing the ◀ or ▶ button.

-
- ◆ When the **Source** is set to **TV**, you can select the channel of sub picture.
 - ◆ You can select the channel of the sub picture simply by pressing the ▼ or ▲ button.

15 When you have finished, press the **EXIT** (→) button to exit.

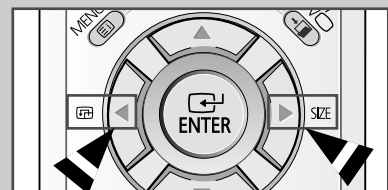
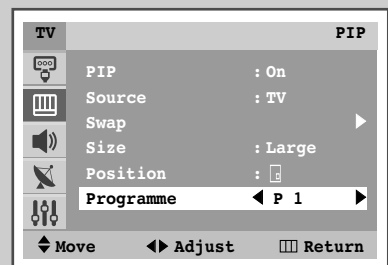
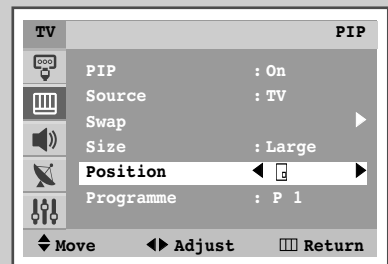
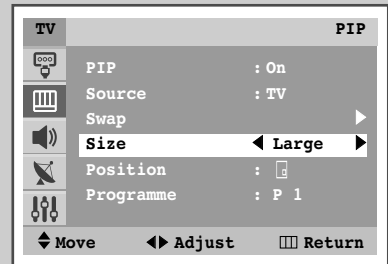

Viewing the Picture In Picture (PIP) (depending on the model) (continued)

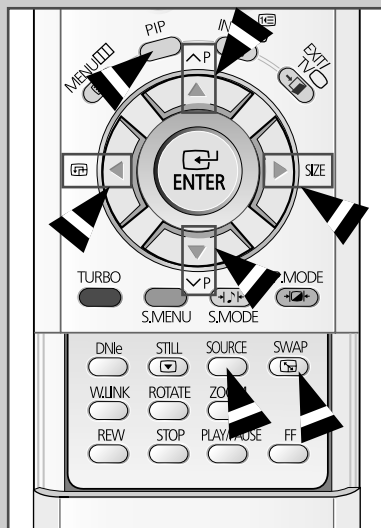

Easy functions of remote control

Buttons	Feature
PIP	Used to activate or deactivate the PIP function directly.
SWAP	Used to interchange the main picture and the sub picture. ➤ When the main picture is in the Video mode and the sub picture is in the TV mode, you might not hear the sound of main picture when pressing the SWAP (SWAP) button after changing the sub picture channel. At this time, reselect the channel of main picture.
SOURCE	Used to assign a source of sub picture (TV – AV1 – AV2 – AV3 – AV4/S-Video).
SIZE	Used to select a size of sub picture (Small, 3PIP, 4PIP, 12PIP or Large).
POSITION (POSITION)	Used to move the sub picture counterclockwise.
P ^ / v	Used to select the channel of sub picture.

Teletext Feature (depending on the model)

Most television channels provide written information services via teletext. Information provided includes:

- ◆ Television programme times
- ◆ News bulletins and weather forecasts
- ◆ Sports results
- ◆ Travel information

This information is divided into numbered pages (see diagram).

Part	Contents
A	Selected page number.
B	Broadcasting channel identity.
C	Current page number or search indications.
D	Date and time.
E	Text.
F	Status information. FASTEXT information.

- It can be different from depending on TTX source.
- Teletext information is often divided between several pages displayed in sequence, which can be accessed by:
 - ◆ Entering the page number
 - ◆ Selecting a title in a list
 - ◆ Selecting a colored heading (FASTEXT system)

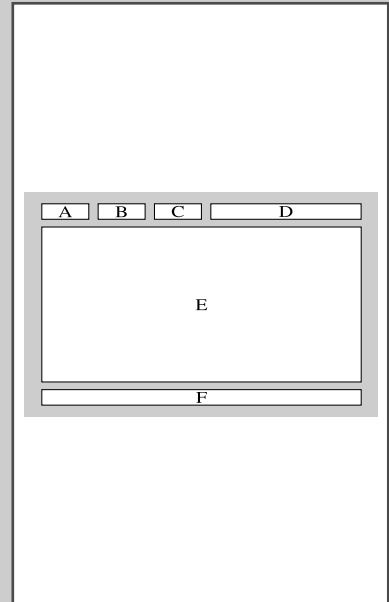

Displaying the Teletext Information (depending on the model)

You can display Teletext information at any time on your television.

- ☞ For Teletext information to be displayed correctly, channel reception must be stable; otherwise:
 - ◆ Information may be missing
 - ◆ Some pages may not be displayed

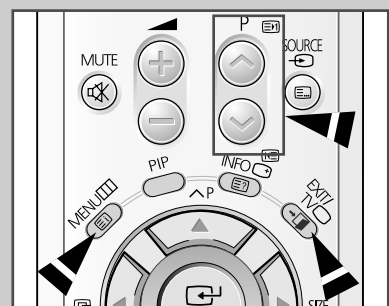
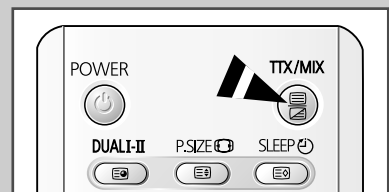



- 1 Select the channel providing the Teletext service using the or button.
- 2 Press the **TTX/MIX** () button to activate the teletext mode.
Result: The contents page is displayed. It can be redisplayed at any time by pressing the (index) button.
- 3 If you wish to display the actual broadcast at the same time as the teletext page, press the **TTX/MIX** () button again.
- 4 Press the **TV** () button to exit from the teletext display.

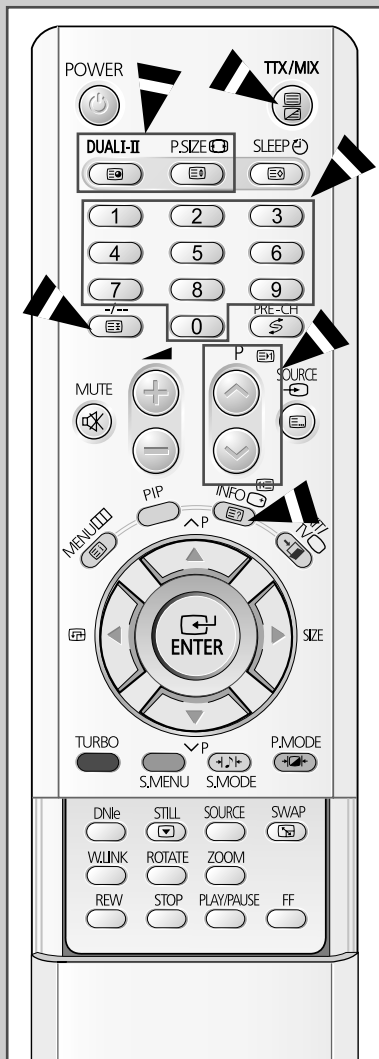







Selecting a Page by Number (depending on the model)



You can enter the page number directly by pressing the numeric buttons on the remote control.

- 1 Enter the three-digit page number given in the content by pressing the corresponding numeric buttons.
Result: The current page counter is incremented and the page is then displayed.
- 2 If the selected page is linked with several secondary pages, the secondary pages are displayed in sequence. To freeze the display on a given page, press the  (hold). Press the  (hold) again to resume.

Using the various display options:

To display...	Press the...
◆ Both teletext information and the normal broadcast	TTX/MIX ( / ) twice
◆ Hidden text (answers to quiz games, for example)	 (reveal)
◆ The normal screen	 (reveal) again
◆ A secondary page, by entering its 4-digit number	 (sub-page)
◆ The next page	 (page up)
◆ The previous page	 (page down)
◆ Double-size letters in the: <ul style="list-style-type: none"> • Upper half of the screen • Lower half of the screen 	 (size) <ul style="list-style-type: none"> • Once • Twice
◆ Normal screen	<ul style="list-style-type: none"> • Three times

Using FLOF to Select a Page (depending on the model)

The various topics included in the teletext pages are color-coded, and can be selected by pressing the colored buttons on the remote control.

- 1 Display the teletext contents page by pressing the **TTX/MIX** (☰/☒) button.
- 2 Press the colored button corresponding to the topic that you wish to select; the available topics are given on the status line.
Result: The page is displayed with other colored information that can be selected in the same way.
- 3 To display the previous or next page, press the corresponding colored button.
- 4 To display the subpage, see the following steps.
 - ◆ Press the (sub-page) button.
Result: The available subpages appear.
 - ◆ Select the required sub-page. Sub-pages can be scrolled by using the **TURBO** (Red) or **S.MENU** (Green) button.

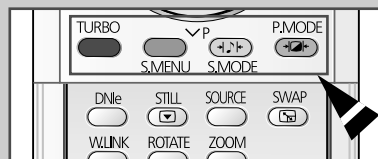
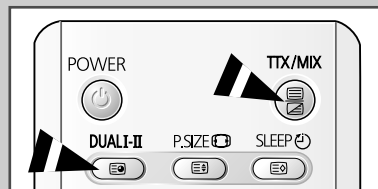

Storing Teletext Pages (depending on the model)

You can store up to four teletext pages to display them later at leisure.

- 1 Select the LIST mode using the (☰) button.
Result: Four 3-digit numbers are displayed in different colors.
➤ The (☰) button is used to switch between the LIST and FLOF (or FASTEXT) modes.
- 2 Press the colored button corresponding to the page that will be replaced.
- 3 Enter the new page number using the numeric buttons.
- 4 Repeat steps 2 and 3 for each page to be stored, using a different colored button each time.
- 5 Press the (☒) (store) button until the corresponding blocks blink.

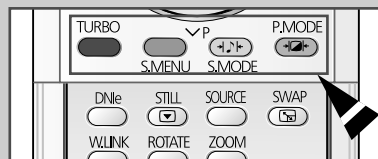
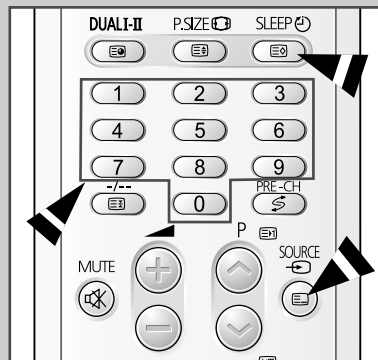

Connecting to the External Input/Outputs

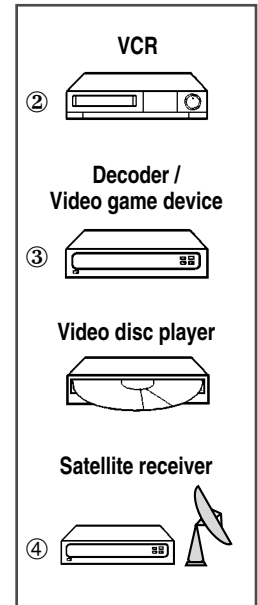
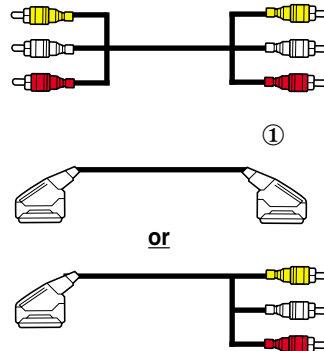
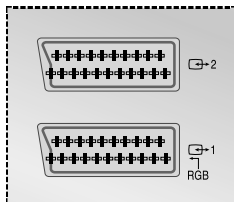
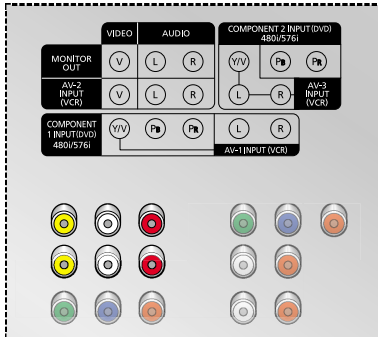

Rear of the TV (depending on the model)







◆ “**MONITOR OUT** (or )” is used for the audio/video output of current television programme.

① This end can be fitted with:

- ◆ A SCART connector
- ◆ Three RCA connectors (Video + Audio-L and R)

② If you have a second VCR and wish to copy cassettes tape, connect the source VCR to “**AV 2 INPUT (VCR)** (or )” and the target VCR to “**MONITOR OUT** (or )” so that you can redirect the signal from “**AV 2 INPUT (VCR)** (or )” to “**MONITOR OUT** (or )”.

③ If you have a decoder, connect the decoder to the VCR and the VCR to the television.

④ When you wish to record a programme, connect the receiver to “**AV 2 INPUT (VCR)** (or )” and the VCR to “**MONITOR OUT** (or )” so that you can redirect the signal from “**AV 2 INPUT (VCR)** (or )” to “**MONITOR OUT** (or )”.



Whenever you connect an audio or video system to your television, ensure that all elements are switched off. Refer to the documentation supplied with your equipment for detailed connection instructions and associated safety precautions.

Connecting to the DVD Player or DTV receiver (depending on the model)

Rear of the TV (depending on the model)

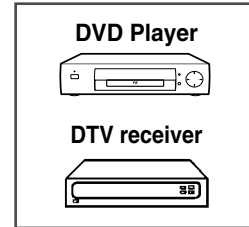
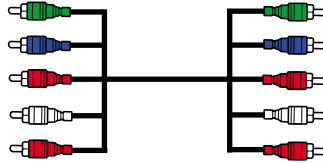
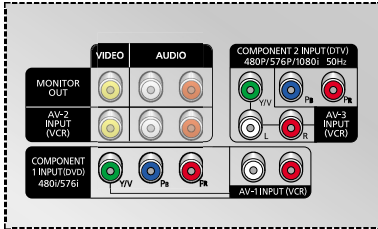

- ◆ Connect the RCA Cable to “L” and “R” on the rear of your television and the other end to “Audio Out” connector of the DVD player or DTV receiver. Connect the RCA Cable to “Y”, “PB”, and “PR” on the rear of your television and the other end to the “Component Video Out (Y, PB, PR)” connectors of the DVD player or DTV receiver.
- ◆ If you wish to connect both the DVD player and DTV receiver, you should connect the DVD player to the “Component1” and connect the DTV receiver to the “Component2”.

- If you change the output resolution of an external device at will, the video from the device may not be displayed on the TV because the resolution is not automatically switched. Check the available input ports for each resolution.

	480i/576i	480P/576P	1080i (50Hz)
Component1	○	X	X
Component2	X	○	○

Connecting to the Audio Output

- The **MONITOR OUT (L-AUDIO-R)** connectors are used for equipment, such as an audio system (to take full advantage of the Surround sound effect).

Rear of the TV (depending on the model)

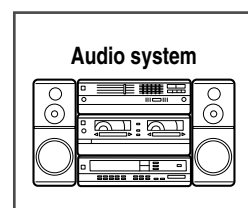
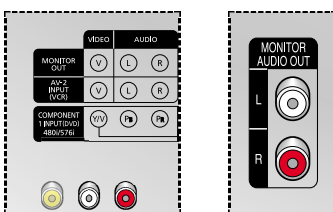

Connecting to the RCA Input

- The RCA (**VIDEO** and **AUDIO-L+R**) connectors are used for equipment, such as camcorders, video disc players, and some video game devices.

Side of the TV (RCA Model)

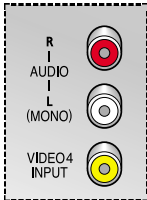

Side of the TV (SCART Model)

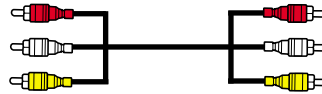
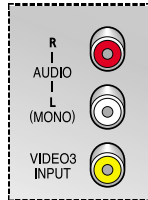

Camcorder

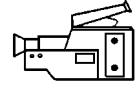

Video game device

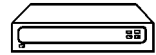

Video disc player



Connecting to the S-Video Input

- The **S-VIDEO** and RCA (**AUDIO-L+R**) connectors are used for equipment with an S-Video output, such as a camcorder or VCR.

Side of the TV

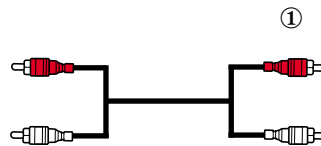

and



Camcorder

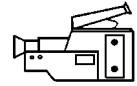

VCR

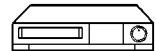

- ① To play pictures and sound, both the S-VIDEO and RCA connectors must be used.



When both the side AV and rear connectors are connected to external equipments, the side AV receives priority.

Viewing Pictures From External Sources

Once you have connected up your various audio and video systems, you can view different sources by selecting the appropriate input.

1 Check that all the necessary connections have been made.

2 Switch your television on, then press the **SOURCE** () button repeatedly.

Result: The input sources are displayed in the following order:

- ◆ AV1 - AV2 - AV3 - AV4/S-Video - Component1 - Component2. (RCA Model)
- ◆ TV - AV1 - AV2 - AV3/S-Video (SCART Model)

➤ Depending on the source selected, the pictures may appear automatically.

➤ To watch television programmes again, press the **TV** () button and select the number of the channel required.

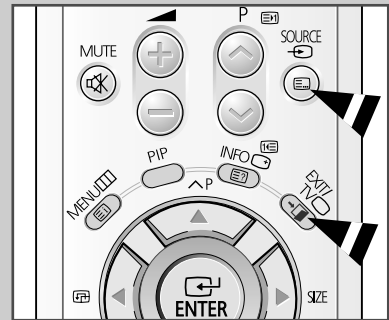

Automatic Degaussing to Remove Color Patches

A degaussing coil is mounted around the picture tube, so you do not normally need to degauss the television manually.

If you move the television to a different position and color patches appear on the screen, you must:

- ◆ Switch the television off by pressing the “⓪” (On/Off) button on the front panel
- ◆ Unplug the television from the wall socket
- ◆ Leave the television power-off for about 30 minutes so that the automatic degauss function can be activated, and then press the “POWER(⓪)” button on the remote control.



If your television will be left unattended, press the “⓪” (On/Off) button to turn your television off.

Troubleshooting: Before Contacting Service Personnel

Before contacting Samsung after-sales service, perform the following simple checks.

If you cannot solve the problem using the instructions below, note the model and serial number of the television and contact your local dealer.

No sound or picture	<ul style="list-style-type: none">◆ Check that the mains lead has been connected to a wall socket.◆ Check that you have pressed the “⓪” button (On/Off) and the POWER (⓪) button.◆ Check the picture contrast and brightness settings.◆ Check the volume.
Normal picture but no sound	<ul style="list-style-type: none">◆ Check the volume.◆ Check whether the MUTE (ⓧ) button on the remote control has been pressed.
No picture or black and white picture	<ul style="list-style-type: none">◆ Adjust the color settings.◆ Check that the broadcast system selected is correct.
Sound and picture interference	<ul style="list-style-type: none">◆ Try to identify the electrical appliance that is affecting the television, then move it further away.◆ Plug your television into a different mains socket.
Blurred or snowy picture, distorted sound	<ul style="list-style-type: none">◆ Check the direction, location and connections of your aerial. This interference often occurs due to the use of an indoor aerial.
Remote control malfunctions	<ul style="list-style-type: none">◆ Replace the remote control batteries.◆ Clean the upper edge of the remote control (transmission window).◆ Check the battery terminals.

Memo

Memo

Memo

– AFTER SALES SERVICE

- Do not hesitate to contact your retailer or service agent if a change in the performance of your product indicates that a faulty condition may be present.

