



LCD TV

LW15E23CB

LW17E24CB

Owner's Instructions

Before operating the unit,
please read this manual thoroughly,
and retain it for future reference.

ON-SCREEN MENUS
PC DISPLAY
PICTURE IN PICTURE (PIP)
TELETEXT

Caution

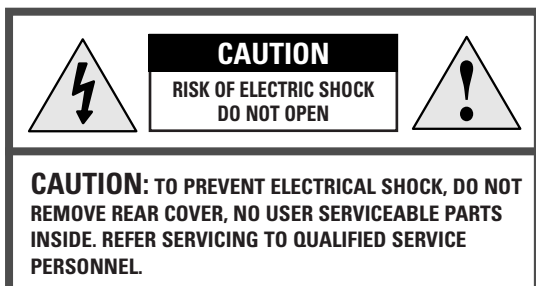

The lightning flash and arrow head within the triangle is a warning sign alerting you of “dangerous voltage” inside the product.

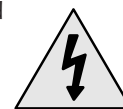

The exclamation point within the triangle is a warning sign alerting you of important instructions accompanying the product.



WARNING: TO PREVENT DAMAGE WHICH MAY RESULT IN FIRE OR SHOCK HAZARD, DO NOT EXPOSE THIS APPLIANCE TO RAIN OR MOISTURE.

 *The main voltage is indicated on the rear of your set and the frequency is 50 or 60 Hz.*

Information in this document is subject to change without notice.

© 2002 Samsung Electronics Co., Ltd. All rights reserved.

Reproduction in any manner whatsoever without the written permission of Samsung Electronics Co., Ltd. is strictly forbidden.

Samsung Electronics Co., Ltd. shall not be liable for errors contained herein or for incidental or consequential damages in connection with the furnishing, performance, or use of this material.

The **Samsung logo** is the registered trademarks of Samsung Electronics Co., Ltd.; **VESA**, **DPMS** and **DDC** are registered trademarks of Video Electronics Standard Association; the **ENERGY STAR** name and logo are registered trademarks of the U.S. Environmental Protection Agency (EPA). As an ENERGY STAR Partner, Samsung Electronics Co., Ltd. has determined that this product meets the **ENERGY STAR** guidelines for energy efficiency. All other product names mentioned herein may be the trademarks or registered trademarks of their respective owners.

European Notice

Products with the CE Marking comply with both the EMC Directive (89/336/EEC), (92/31/EEC), (93/68/EEC) and the Low Voltage Directive (73/23/EEC) issued by the Commission of the European Community. Compliance with these directives implies conformity to the following European Norms:

- EN55022:1998 – Radio Frequency Interference
- EN55024:1998 – Electromagnetic Immunity
- EN61000-3-2:1995 + A1 + A2 – Power Line Harmonics
- EN61000-3-3:1995 – Voltage Fluctuations
- EN60950 – Product Safety.

Safety Instructions

These illustrations represent precautions concerning your TV.

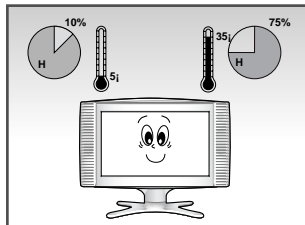

◀ Do NOT expose the TV to extreme temperature conditions or to extreme humidity conditions.

Do NOT expose the TV to direct sunlight. ▶

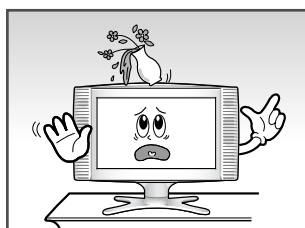
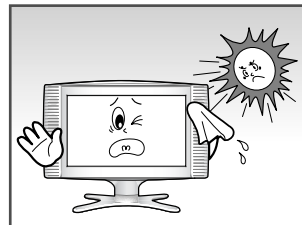

◀ Do NOT expose the TV to any liquids.

If the TV is broken, do not try to repair it yourself. Contact qualified service personnel. ▶

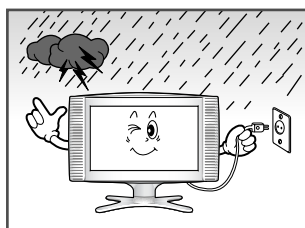
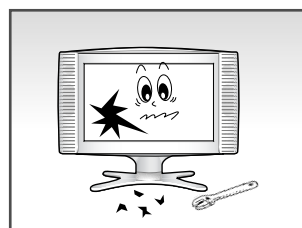

◀ During a storm conditions (especially when there is lightning) unplug the TV from the mains socket and aerial.

Keep all power adaptors apart. Possible fire hazard. ▶

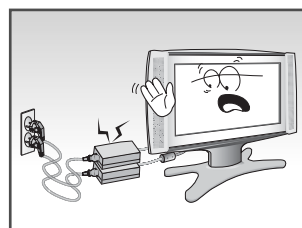

◀ Always keep the power adaptor in a well-ventilated area.

Remove and discard the plastic cover from the power adaptor before use. Possible fire hazard. ▶

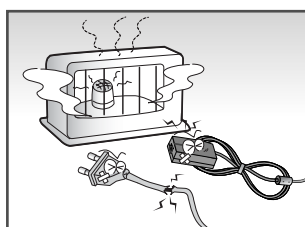
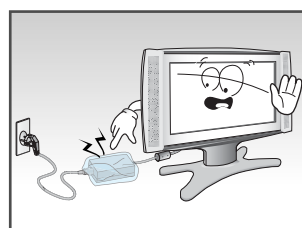

◀ Keep the power adaptor away from any other heater. Possible fire hazard.

If the remote control is not used for a long period of time, remove the batteries and store it in a cool, dry place. ▶

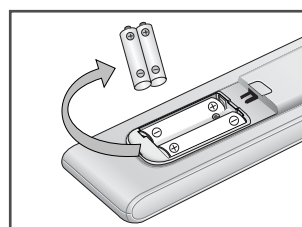

THIS DEVICE IS NOT FOR USE IN INDUSTRIAL ENVIRONMENTS

Contents

◆ FOREWORD	
■ Caution	2
■ Safety Instructions	3
◆ CONNECTING AND PREPARING YOUR TV	
■ Viewing the Control Panel.....	6
■ Viewing the Connection Panel	7
– Connecting an Aerial or Cable Television Network.....	8
– Connecting DTV Set-Top Box, VCR, or DVD.....	8
– Connecting Computer	8
– Connecting External A/V Devices	9
– Kensington Slot.....	9
■ Viewing Pictures From External Sources.....	9
■ Attaching a Wall or Arm Mounting Device	10
■ Installing VESA Compliant Mounting Device.....	10
■ Inserting the Batteries in the Remote Control.....	11
■ Viewing the Remote Control (All Functions Except Teletext).....	12
■ Viewing the Remote Control (Teletext Functions)	13
■ Switching On and Off	14
■ Placing in Standby Mode	14
■ Becoming Familiar with the Remote Control.....	15
■ Choosing Your Language.....	16
◆ SETTING THE CHANNELS	
■ Storing Channels Automatically.....	17
■ Storing Channels Manually.....	18
■ Giving Channels Names.....	19
■ Skipping Unwanted Channels	20
■ Fine Tuning Channel Reception.....	20
■ Sorting the Stored Channels	21
◆ USING THE VARIOUS FUNCTIONS (continued)	
■ Changing the Picture Standard	22
■ Adjusting the Picture Settings	22
■ Selecting the Picture Format.....	23
■ Freezing the Current Picture.....	23

Contents (continued)

◆ USING THE VARIOUS FUNCTIONS	
■ Changing the Sound Standard	24
■ Adjusting the Sound Settings	24
■ Enjoying the Dolby Sound.....	25
■ Selecting the Sound Mode.....	25
■ Viewing the Picture In Picture (PIP).....	26
■ Switching Off Automatically.....	27
■ Displaying Information.....	27
◆ USING THE PC FUNCTIONS	
■ Setting up Your PC Software (Based on Windows 98).....	28
■ Adjusting the Brightness and Contrast	29
■ Adjusting the Image Quality.....	30
■ Changing the Image Position.....	31
■ Adjusting the Color	32
■ Initializing the Image Settings.....	33
◆ USING THE TELETEXT FEATURE	
■ Teletext Feature	34
■ Displaying the Teletext Information	35
■ Selecting a Page by Number	36
■ Using FLOF to Select a Page	37
■ Storing Teletext Pages.....	37
◆ RECOMMENDATIONS FOR USE	
■ Troubleshooting: Before Contacting Service Personnel	38
■ Power Saver	39
■ Technical and Environmental Specifications.....	40
■ Display Modes	41
■ Maintenance of Your Television.....	41
■ Wiring the Mains Power Supply Plug (UK Only)	42

Symbols



Press



Important



Note

Viewing the Control Panel

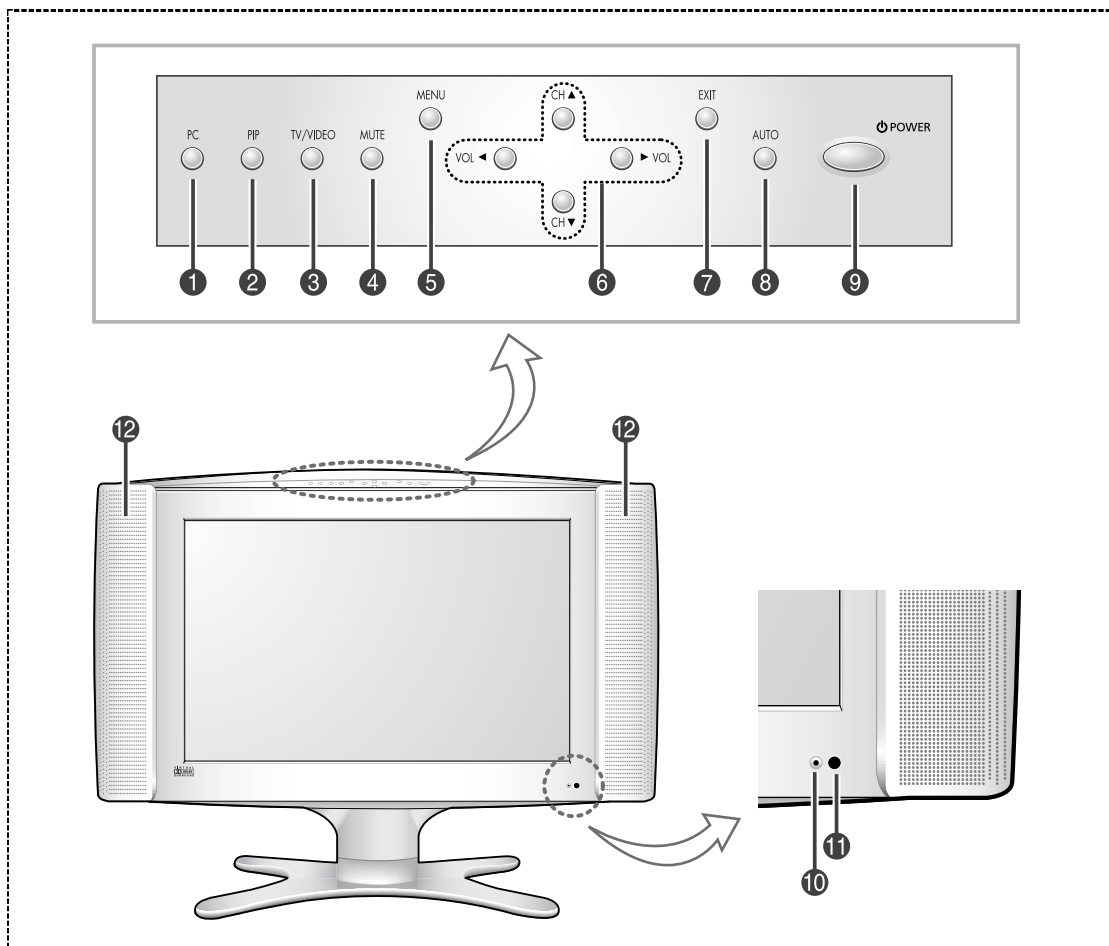

- 1 PC**
Selects PC source
- 2 PIP**
Activates PIP (Picture-In-Picture) directly in PC mode.
- 3 TV/VIDEO**
Displays a menu of all of the available input sources (TV/Video1/Video2/S-Video).
- 4 MUTE**
Temporary sound switch off
- 5 MENU**
Opens the on-screen menu.
- 6 CH▲ / CH▼**
Moves the selector up or down on the OSD. Increases or decreases the channel number.
- 6 VOL< / >VOL**
Moves the selector left or right on the OSD. Increases or decreases the level of audio volume and the values of the selected function.
- 7 EXIT**
Exits from the on-screen menu.
- 8 AUTO**
Allows you experience the quality of displayed picture. The values of fine, coarse and position are adjusted automatically. (It works PC mode only.)
- 9 ⏻ POWER**
Turns ON/OFF your set.
- 10** Power Indicator
- 11** Remote Control Sensor
- 12** Speakers

Viewing the Connection Panel (continued)

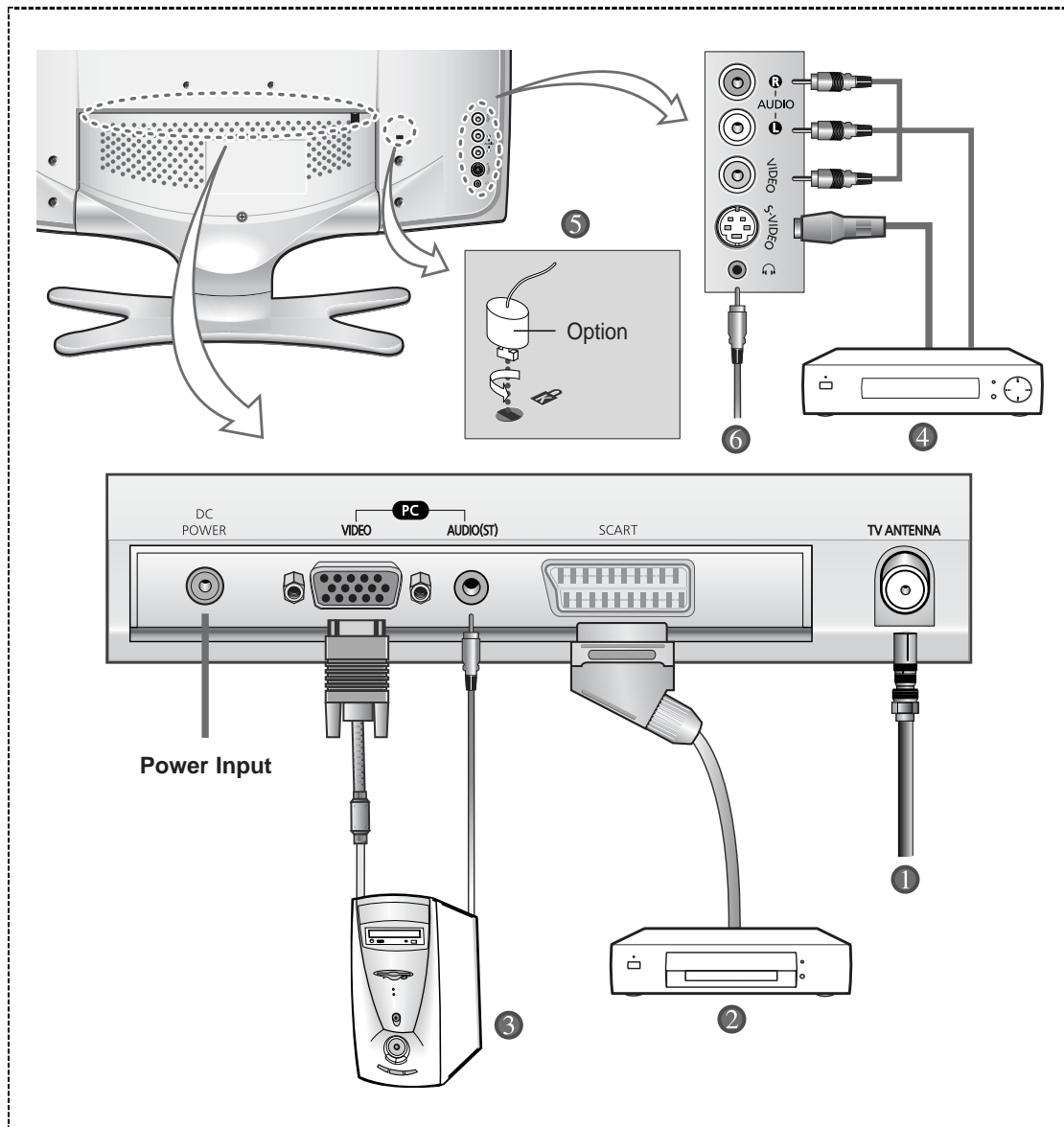

✎ Whenever you connect an audio or video system to your set, ensure that all elements are switched off. Refer to the documentation supplied with your equipment for detailed connection instructions and associated safety precautions.

Viewing the Connection Panel (continued)

1 Connecting an Aerial or Cable Television Network (depending on the model)

To view television channels correctly, a signal must be received by the set from one of the following sources:

- An outdoor aerial
- A cable television network
- A satellite network

2 Connecting DTV Set-Top Box, VCR, or DVD

- Connect the DTV, VCR, or DVD SCART cable to the SCART connector of the DTV, VCR, or DVD.
- If you wish to connect both the DTV Set-Top Box and VCR (or DVD), you should connect the DTV Set-Top Box to the VCR (or DVD) and connect the VCR (or DVD) to your set.

3 Connecting Computer

- Connect the 15 Pin D-SUB connector to the PC video connector.
- Connect the stereo audio cable to "Audio (ST)" on the rear of your set and the other end to "Audio Out" of the sound card on your computer.
- If necessary, please install monitor driver contained on the accompanied CD. For more information, refer to the driver installation instructions included with your CD package.

➤ 15 Pin D-SUB connector

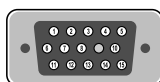

Pin	Separate H/V	Composite H/V
1	Red (R)	Red (R)
2	Green (G)	Green (G)
3	Blue (B)	Blue (B)
4	Grounding	Grounding
5	Grounding (DDC return)	Grounding (DDC return)
6	Grounding - Red (R)	Grounding - Red (R)
7	Grounding - Green (G)	Grounding - Green (G)
8	Grounding - Blue (B)	Grounding - Blue (B)
9	No connection	No connection
10	Grounding - Sync. / Self test	Grounding - Sync. / Self test
11	Grounding	Grounding
12	DDC - SDA (Date)	DDC - SDA (Date)
13	Horizontal Sync.	Horizontal/Vertical Sync.
14	Vertical Sync.	Not used
15	DDC - SCL (Clock)	DDC - SCL (Clock)

Viewing the Connection Panel (continued)

4 Connecting External A/V Devices

- Connect RCA or S-VIDEO cable to an appropriate external A/V device such as VCR, DVD, or Camcorder.
- Connect RCA audio cables to "AUDIO (L)" and "AUDIO (R)" on the rear of your set and the other ends to corresponding audio out connectors on the A/V device.
- Headphone may be connected to the headphone output (6) on the rear of your set. *While the headphone is connected, the sound from the built-in speakers will be disabled.*

5 Kensington Slot

- This television has been designed to apply a burglarproof lock.

➤ Retractable Stand

Tilt the screen until you feel comfortable. The maximum tilt angle is 15 degree to the backward direction. Please do not tilt the television other than specified range.

Excessive force to tilt the television other than specified range may give permanent damage to the mechanical part of the stand.

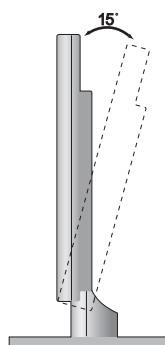

Viewing Pictures From External Sources

Once you have connected up your various audio and video systems, you can view the different sources by selecting the appropriate input.

- 1 Check that all the necessary connections have been made (refer to pages 8 and 9 for further details).
- 2 Switch your set on and if necessary, press the **TV/VIDEO** button repeatedly. The input sources are displayed in the following order:

TV — VIDEO1 — VIDEO2 — S-VIDEO.

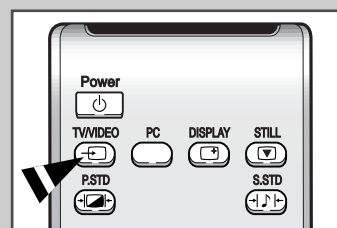

Attaching a Wall or Arm Mounting Device

This television supports VESA mounting standard for use with various VESA mounting devices. To install any VESA mounting device, please follow the instructions given.

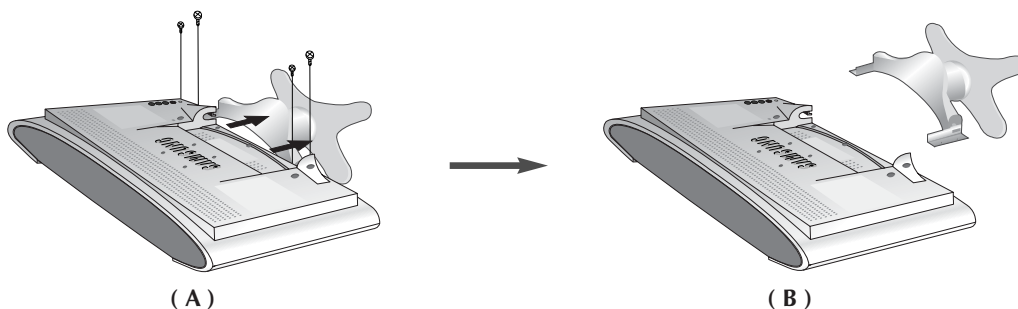

- 1 Lay the television face-down on a flat surface with a cushion or other soft materials to protect the screen.
- 2 Remove all cable connected on the television.
- 3 Remove the four screws and then remove the Stand from the television.
- 4 Connect all cable you removed at step 2.
- 5 Now you are ready to install **Wall/Arm mounting device** depending on your applications.

Installing VESA Compliant Mounting Device

Align the mounting interface pad with the holes in the rear cover mounting pad and secure it with the four screws that came with the arm-type base, wall mount hanger or other bases.

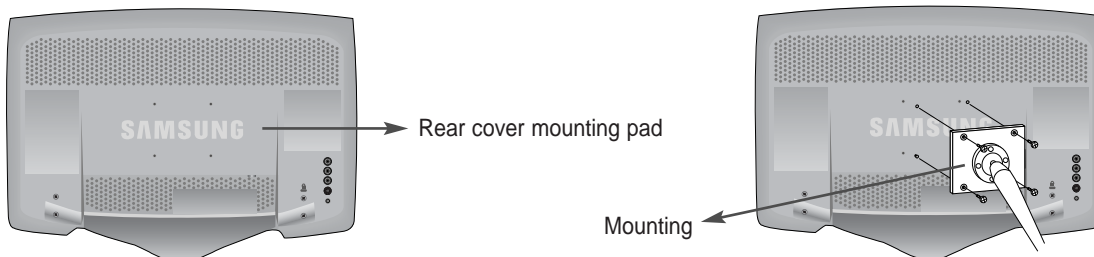

Inserting the Batteries in the Remote Control

You must insert or replace the batteries in the remote control when you:

- ◆ *Purchase your set*
- ◆ *Find that the remote control is no longer operating correctly*

- 1 Remove the cover on the rear of the remote control by pressing the symbol downwards and then pulling firmly to remove it.
- 2 Insert two R03, UM4, "AAA" 1.5V or equivalent batteries taking care to respect the polarities:
 - ◆ + on the battery against + on the remote control
 - ◆ - on the battery against - on the remote control
- 3 Replace the cover by aligning it with the base of the remote control and pressing it back into place.

➤ Do not mix battery types, i.e. alkaline and manganese.

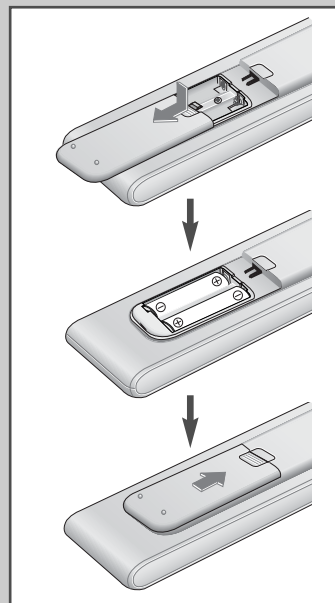

Viewing the Remote Control (All Functions Except Teletext)

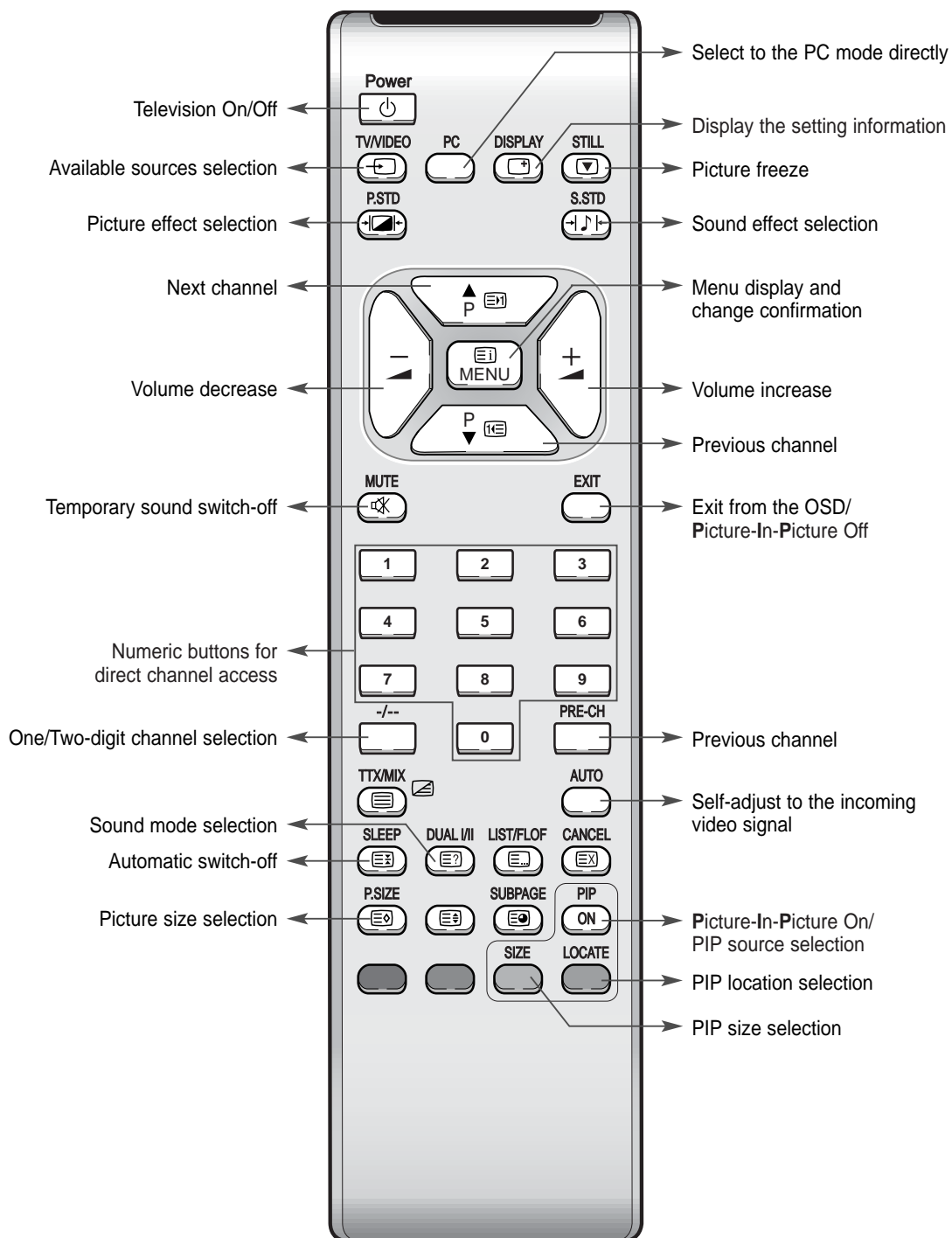

➤ The performance of the remote control may be affected by bright light.

Viewing the Remote Control (Teletext Functions)

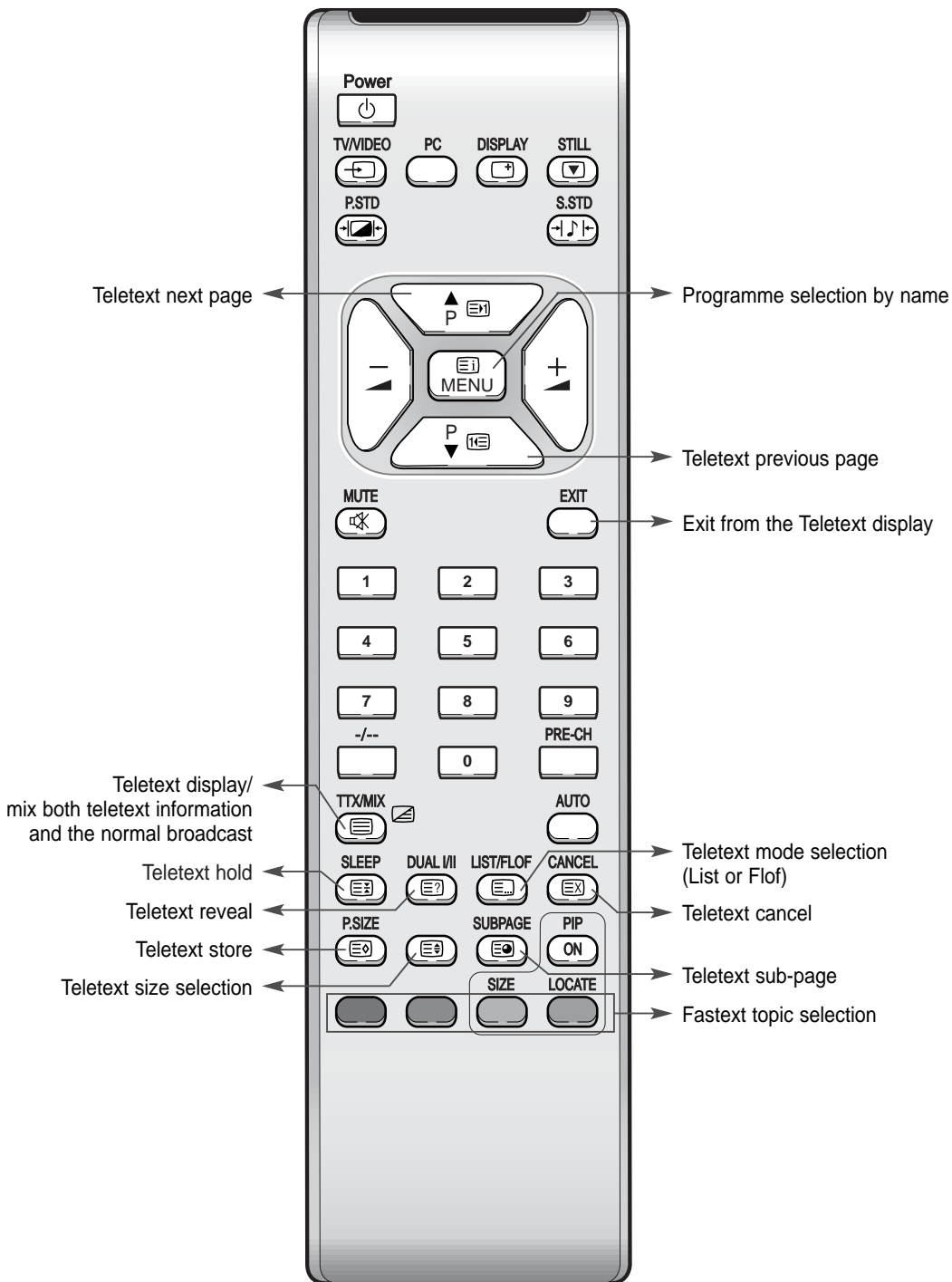

Switching On and Off

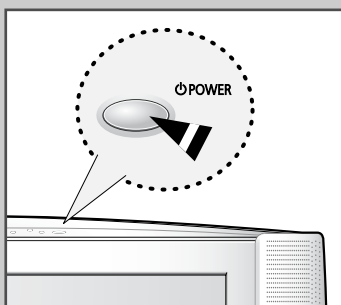
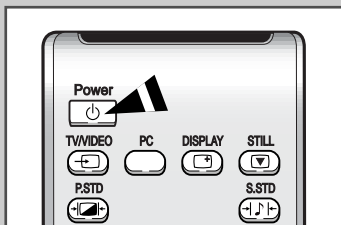

The mains lead is attached to the rear of your set.

☞ If you have purchased this set in the United Kingdom, refer to page 42 for further instructions on plug wiring.

- 1 Plug the mains lead into an appropriate socket.
Result: A Standby indicator lights off on the front panel.
- 2 Press the **Power** (⏻) button to switch on.
- 3 To switch off, press the **Power** (⏻) button again.

Placing in Standby Mode

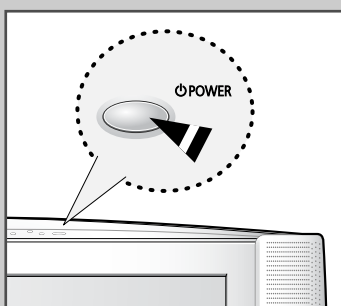
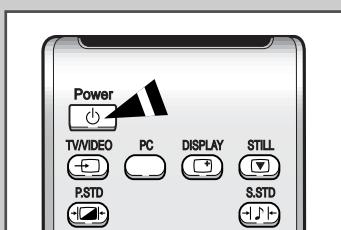

Your set can be placed in Standby mode, in order to reduce the power consumption.

The Standby mode can be useful when you wish to interrupt viewing temporarily (during a meal, for example).

- 1 Press the **Power** (⏻) button.
- 2 To switch back on, simply press the **Power** (⏻) button again or a numeric button.

➤ Do not leave your set in Standby mode for long periods of time (when you are away on holiday, for example). Turn off by pressing the (⏻) button. It is best to unplug the set from the mains and aerial.

Becoming Familiar with the Remote Control

The remote control is used mainly to:

- ◆ Change channels and adjust the volume
- ◆ Set up your set using the on-screen menu system

The following table presents the most frequently used buttons and their functions.

Button	Viewing Function	Menu Function
▲ P	Used to display the next stored channel.	Used to select the previous menu option.
P ▼	Used to display the previous stored channel.	Used to select the next menu option.
PRE-CH	Used to switch repeatedly between the last two channels displayed. (PRE-CH ; Previous Channel)	
0 to 9	Used to display the corresponding channels.	
-/--	Used to select a channel numbered ten or over. Press this button, and the "--" symbol is displayed. Enter the two-digit channel number.	
— ▲	Used to decrease the volume.	Used to... <ul style="list-style-type: none"> ◆ Display a submenu containing selections for the current menu option. ◆ Search forwards manually for channels ◆ Reduce a menu option value.
+ ▲	Used to increase the volume.	Used to... <ul style="list-style-type: none"> ◆ Display a submenu containing selections for the current menu option. ◆ Search backwards manually for channels ◆ Increase a menu option value.
MUTE	Used to switch the sound off temporarily. <ul style="list-style-type: none"> ➤ To turn the sound back on, press this button again, or press the — or + button. 	
MENU	Used to display the on-screen menu system.	Used to return to the previous menu or normal viewing.
EXIT	Used to exit from the menu system and return to normal viewing directly.	

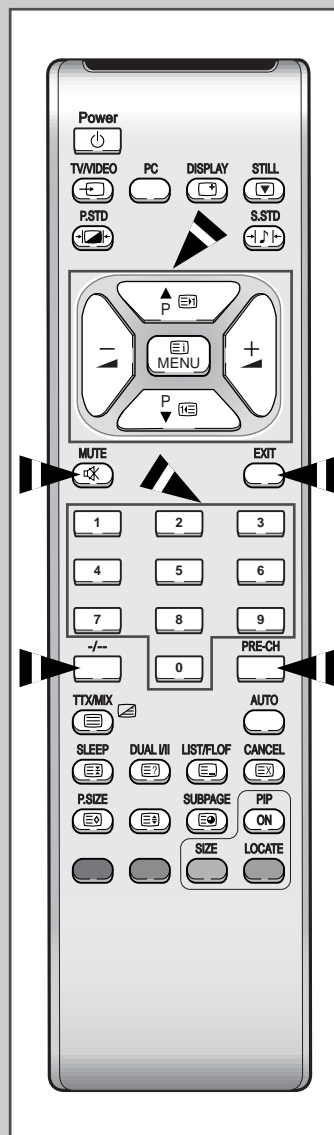

Choosing Your Language

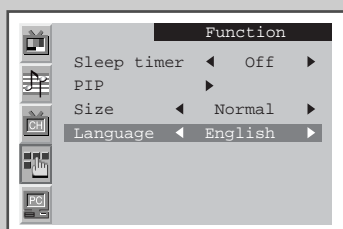
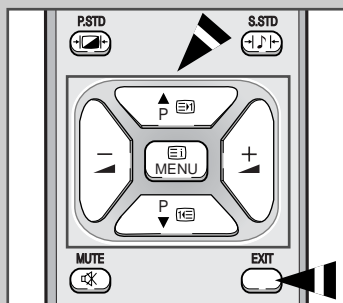

When you start using your set for the first time, you must select the language which will be used for displaying menus and indications.

- 1 Press the **MENU** button.
Result: The main menu is displayed.
- 2 Press the **P▼** or **P▲** button to select the **F**unction.
Result: The options available in the **F**unction group are displayed.
- 3 Press the **◀-** or **▶+** button.
- 4 Press the **P▼** or **P▲** button to select the **L**anguage.
- 5 Select a particular language by pressing the **◀-** or **▶+** button repeatedly.
- 6 When you are satisfied with your choice, press the **EXIT** button to return to normal viewing.

Storing Channels Automatically

You can scan for the frequency ranges available to you (and availability depends on your country). Automatically allocated programme numbers may not correspond to actual or desired programme numbers. However you can sort numbers manually and clear any channels you do not wish to watch.

- 1 Press the **MENU** button.

Result: The main menu is displayed.

- 2 Press the **P▼** or **P▲** button to select the **Channel**.

Result: The options available in the **Channel** group are displayed.

- 3 Press the **◀-** or **▶+** button.

Result: The **Auto store** is selected.

- 4 Press the **◀-** or **▶+** button again.

Result: The options available in the **Auto store** group are displayed with the **Country** is selected.

- 5 Select your country by pressing the **◀-** or **▶+** button repeatedly. The following countries are available:

Belgie - Deutschland - Espania - France - Italia - Nederland - Schweiz - Sverige - UK - East Europe.

- 6 Press the **P▼** or **P▲** button to select the **Search**, and then press the **◀-** or **▶+** button.

Result: The search will end automatically. Channels are sorted and stored in an order which reflects their position in the frequency range, (with lowest first and highest last). The programme originally selected is then displayed.

➤ To stop the search before it has finished, press the **EXIT** button.

- 7 When the channels have been stored, you can:

- ◆ Change channels
- ◆ Assign a name to the stored channels (refer to page 19)
- ◆ Clear a channel (refer to page 20)
- ◆ Fine tune channel reception if necessary (refer to page 20)
- ◆ Sort them in the order required (refer to page 21)

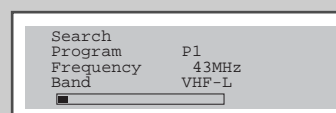
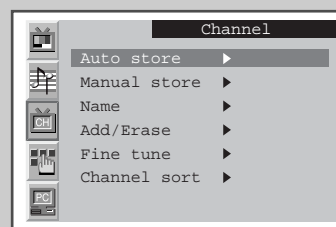

Storing Channels Manually

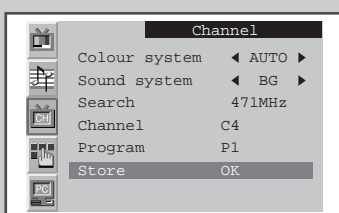
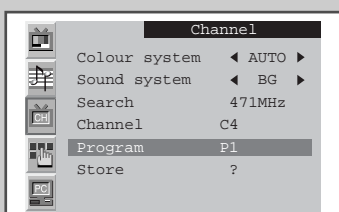
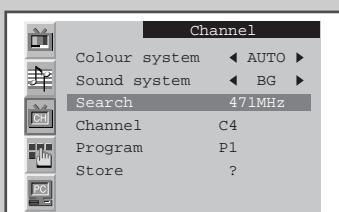
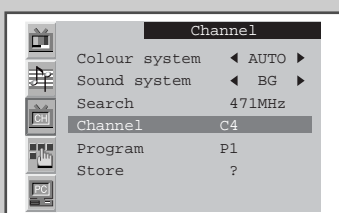
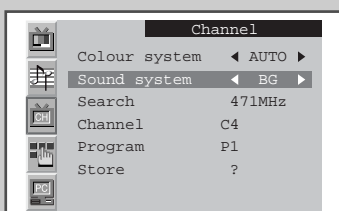
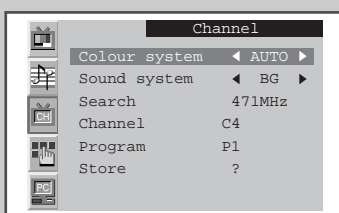
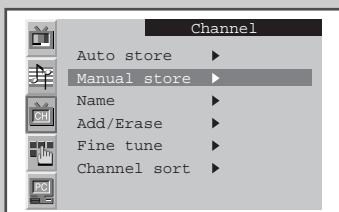

You can store up to 100 channels, including those received via cable networks. When storing channels manually, you can choose:

- ◆ Whether or not to store each of the channels found
- ◆ The programme number of each stored channel which you wish to identify

- 1 Press the **MENU** button.
Result: The main menu is displayed.

- 2 Press the **P▼** or **P▲** button to select the **Channel**.
Result: The options available in the **Channel** group are displayed.

- 3 Press the **◀-** or **▶+** button.

- 4 Press the **P▼** or **P▲** button to select the **Manual store**. Press the **◀-** or **▶+** button.
Result: The options available in the **Manual store** group are displayed with the **Colour system** is selected.

- 5 If necessary, indicate the broadcasting standard required by pressing the **◀-** or **▶+** button repeatedly.
Result: The color standards are displayed in the following order:
AUTO – PAL – SECAM – NT4.43.

- 6 Press the **P▼** or **P▲** button to select the **sound system**. Indicate the sound standard required by pressing the **◀-** or **▶+** button repeatedly.
Result: The sound standards are displayed in the following order:
BG – DK – I – L.

- 7 If you know the channel number to be stored, press the **P▼** or **P▲** button to select the **Channel**. Indicate the required number by pressing the **◀-** or **▶+** button.
If you do not know the channel numbers, press the **P▼** or **P▲** button to select the **Search**. Start the search by pressing the **◀-** or **▶+** button.
Result: The tuner scans the frequency range until the first channel or the channel that you selected is received on your screen.

- 8 To assign a programme number to a channel, select the **Program** by pressing the **P▼** or **P▲** button. Press the **◀-** or **▶+** button to find the correct number.

- 9 Press the **P▼** or **P▲** button to select the **store**. Select the **OK** by pressing the **◀-** or **▶+** button.
Result: The channel and associated programme number are stored.

- 10 Repeat Steps **7** to **9** for each channel to be stored.

Giving Channels Names

If channel name information is broadcast when you store the channels either manually or automatically, the names are assigned to the channels directly. You can however change these names or assign new names as required.

- 1 Press the **MENU** button.
Result: The main menu is displayed.
- 2 Press the **P▼** or **P▲** button to select the **Channel1**.
Result: The options available in the **Channel1** group are displayed.
- 3 Press the **◀-** or **▶+** button.
- 4 Press the **P▼** or **P▲** button to select the **Name**. Press the **◀-** or **▶+** button.
Result: The current channels are displayed.
- 5 If necessary, select the channel to be assigned to a new name by pressing the **P▼** or **P▲** button.
- 6 Press the **◀-** or **▶+** button.
- 7 Press the **P▼** or **P▲** button to select a letter (A~Z), a number(0~9) or a symbol (-, space). Move on the previous or next letter by pressing the **◀-** or **▶+** button.
- 8 Repeat Steps 5 to 7 for each channel to be assigned to a new name.

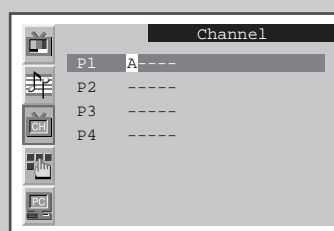
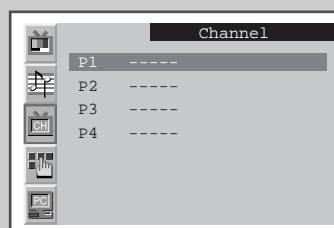
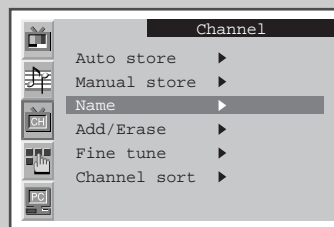

Skipping Unwanted Channels

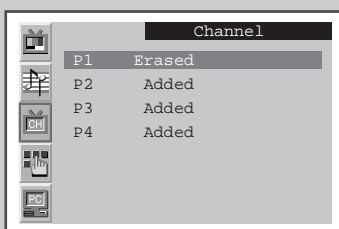
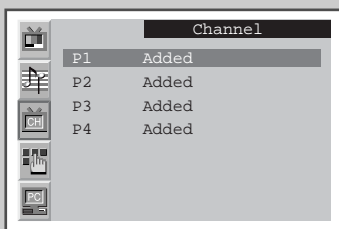
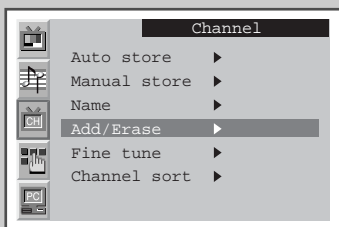

You can exclude the channels you chosen from the channels you scanned. When you scan through the stored channels, those you have chosen to skip are not displayed.

All channels that you do not specifically choose to skip are displayed during scanning.

- 1 Press the **MENU** button.
Result: The main menu is displayed.
- 2 Press the **P▼** or **P▲** button to select the **Channel1**.
Result: The options available in the **Channel1** group are displayed.
- 3 Press the **▲-** or **▲+** button.
- 4 Press the **P▼** or **P▲** button to select the **Add/Erase**. Press the **▲-** or **▲+** button.
Result: The stored channels are displayed.
- 5 Press the **P▼** or **P▲** button to select the channel to add or erase. If necessary, select the **Added** or **Erased** by pressing the **▲-** or **▲+** button.
- 6 Repeat Step 5 for each channel to be added or erased.

Fine Tuning Channel Reception

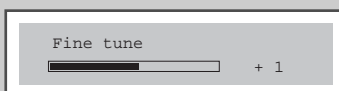
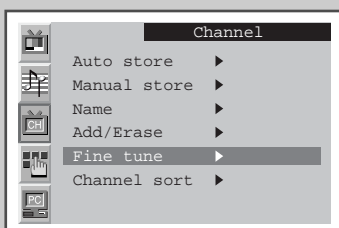

If the reception is clear, you do not have to fine-tune the channel, as this is done automatically during the search and store operation. If however the signal is weak or distorted, you may have to fine-tune the channel manually.

- 1 Press the **MENU** button.
Result: The main menu is displayed.
- 2 Press the **P▼** or **P▲** button to select the **Channel1**.
Result: The options available in the **Channel1** group are displayed.
- 3 Press the **▲-** or **▲+** button.
- 4 Press the **P▼** or **P▲** button to select the **Fine tune**.
- 5 Obtain a sharp and clear picture and good sound quality by pressing the **▲-** or **▲+** button.

Sorting the Stored Channels

You can exchange the numbers of two channels, in order to:

- ◆ *Modify the numeric order in which the channels have been automatically stored.*
- ◆ *Give easily remembered numbers to the channels that you watch most often.*

- 1 Press the **MENU** button.
Result: The main menu is displayed.

- 2 Press the **P▼** or **P▲** button to select the **Channel**.
Result: The options available in the **Channel** group are displayed.

- 3 Press the **▲-** or **▲+** button.

- 4 Press the **P▼** or **P▲** button to select the **Channel sort**.
Press the **▲-** or **▲+** button.
Result: The options available in the **Channel sort** group are displayed with the **From** is selected.

- 5 Select the channel number that you wish to change by pressing the **▲-** or **▲+** button repeatedly.

- 6 Press the **P▼** or **P▲** button to select the **To**. Select the new number by which you wish to identify the channel by pressing the **▲-** or **▲+** button repeatedly.

- 7 Press the **P▼** or **P▲** button to select the **store**. Select the **OK** to confirm the exchange of channel numbers by pressing the **▲-** or **▲+** button.
Result: The selected channel is exchanged with the one previously stored to the chosen number.

- 6 For all the channels to move to the required channel numbers, repeat steps **5** to **7** after select the **From** by pressing the **P▼** or **P▲** button.

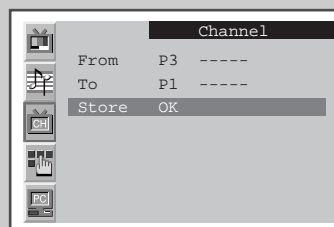
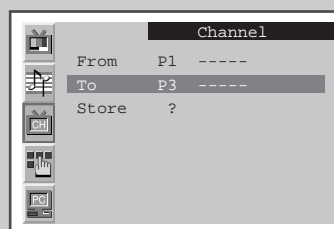
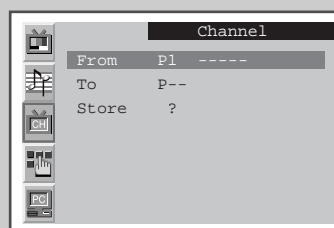
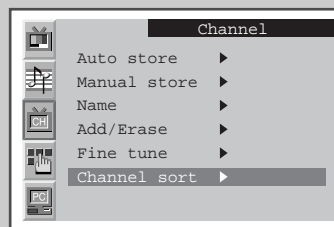

Changing the Picture Standard

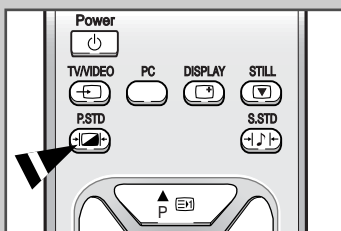
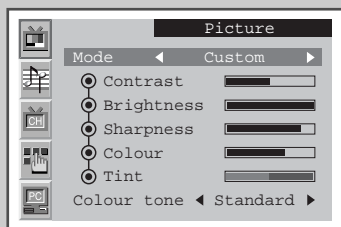

You can select the type of picture which best corresponds to your viewing requirements.

- 1 Press the **MENU** button.
Result: The main menu is displayed.
- 2 Press the **P▼** or **P▲** button to select the **Picture**.
Result: The options available in the **Picture** group are displayed.
- 3 Press the **◀-** or **▶+** button.
Result: The **Mode** is selected.
- 4 Select the required picture effect by pressing the **◀-** or **▶+** button repeatedly. The following picture effects are available:
Dynamic – Standard – Movie – Custom.
➤ You can also set these options simply by pressing the **P.STD** (Picture Standard) button.

- On the **Picture** menu, if you change the **Contrast**, **Brightness**, **Sharpness**, **Color** or **Tint** (NTSC only) settings, the **Custom** is selected automatically.

Adjusting the Picture Settings

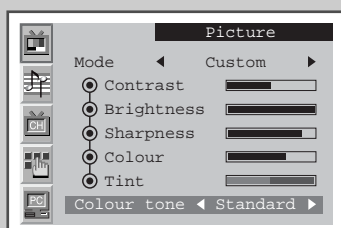
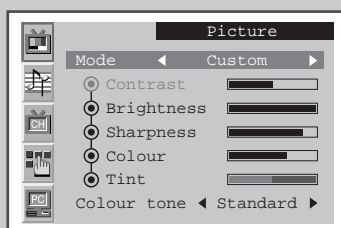

Your set has several settings which allow you to control picture quality.

- 1 Press the **MENU** button.
Result: The main menu is displayed.
- 2 Press the **P▼** or **P▲** button to select the **Picture**.
Result: The options available in the **Picture** group are displayed.
- 3 Press the **◀-** or **▶+** button.
- 4 Select the option (**Contrast**, **Brightness**, **Sharpness**, **Colour** or **Tint**) to be adjusted by pressing the **P▼** or **P▲** button. Press the **◀-** or **▶+** button.
Result: The horizontal bar is displayed.
- 5 Press the **◀-** or **▶+** button to reach the required setting.
- 6 Press the **P▼** or **P▲** button to select the **Colour tone**. Select the required option by pressing the **◀-** or **▶+** button repeatedly. The following options are available:
Cool2 – Cool 1 – Normal – Warm 1 – Warm2.

- If you make any changes to these settings, the picture standard is automatically switched to **Custom**.

Selecting the Picture Format

You can select the picture format which best corresponds to your viewing requirements.

- 1 Press the **MENU** button.
Result: The main menu is displayed.
- 2 Press the **P▼** or **P▲** button to select the **Function**.
Result: The options available in the **Function** group are displayed.
- 3 Press the **◀-** or **▶+** button.
- 4 Press the **P▼** or **P▲** button to select the **Size**.
- 5 Select the required picture format by pressing the **◀-** or **▶+** button repeatedly.
➤ You can also select these options simply by pressing the **P.SIZE** (Picture Size) button.

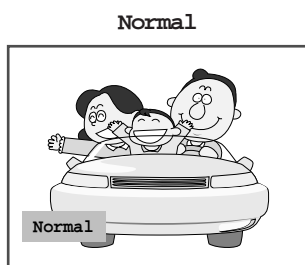
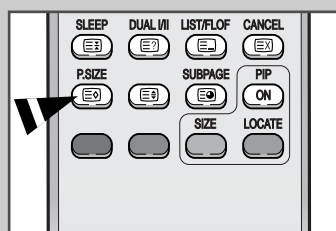
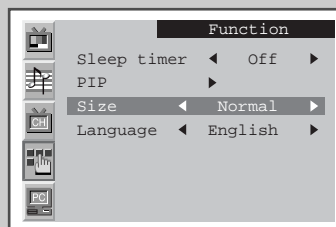

Sets the picture to 4:3 normal mode. This is a standard TV screen size.

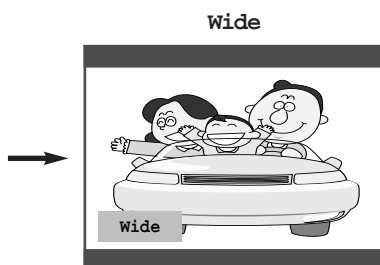

Sets the picture to 16:9 wide mode.

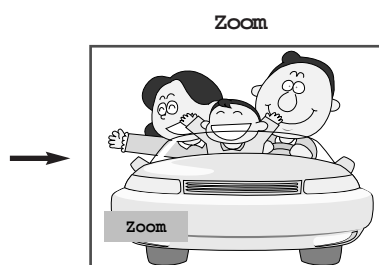

Magnifies the size of the picture on screen.

Freezing the Current Picture

➤ Not Available in PC mode.

Press the **"STILL"** button on the remote control to freeze the picture on a given frame. To return to normal viewing, press the **"STILL"** button again.

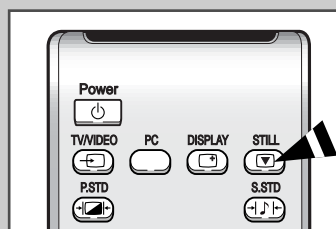

Changing the Sound Standard

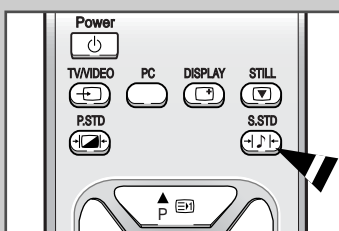
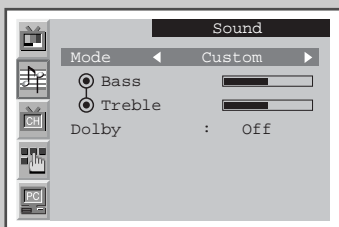

You can select the type of special sound effect to be used when watching a given broadcast.

- 1 Press the **MENU** button.
Result: The main menu is displayed.
- 2 Press the **P▼** or **P▲** button to select the **sound**.
Result: The options available in the **sound** group are displayed.
- 3 Press the **◀-** or **▶+** button.
Result: The **Mode** is selected.
- 4 Select the required sound effect by pressing the **◀-** or **▶+** button repeatedly. The following sound effects are available:
Custom - Standard - Music - Movie - Speech.
➤ You can also set these options simply by pressing the **S.STD** (Sound Standard) button.

Adjusting the Sound Settings

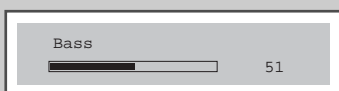

The sound settings can be adjusted to suit your personal preferences.

- 1 Press the **MENU** button.
Result: The main menu is displayed.
- 2 Press the **P▼** or **P▲** button to select the **sound**.
Result: The options available in the **sound** group are displayed.
- 3 Press the **◀-** or **▶+** button.
- 4 Select the option (**Bass** or **Treble**) to be adjusted by pressing the **P▼** or **P▲** button. Press the **◀-** or **▶+** button.
Result: The horizontal bar is displayed.
- 5 Press the **◀-** or **▶+** button to reach the required setting.

➤ If you make any changes to these settings, the sound standard is automatically switched to **Custom**.

Enjoying the Dolby Sound

This feature provides a home theater-like Dolby effect by mixing the left and right speakers.

- 1 Press the **MENU** button.
Result: The main menu is displayed.
- 2 Press the **P▼** or **P▲** button to select the **Sound**.
Result: The options available in the **Sound** group are displayed.
- 3 Press the **◀-** or **▶+** button.
- 4 Press the **P▼** or **P▲** button to select the **Dolby**.
- 5 For enjoying the Dolby sound effect, select the **On** by pressing the **◀-** or **▶+** button.

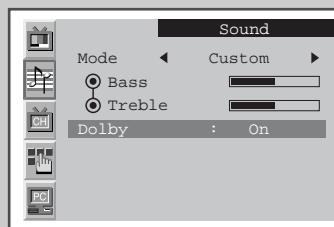

Selecting the Sound Mode

You can set the sound mode by pressing the "DUAL/II" button. When you press it, current sound mode is displayed on the screen.

	Audio type	DUAL 1/2	Default
FM Stereo	Mono	MONO	Automatic change
	Stereo	STEREO ↔ MONO	
	Dual	DUAL 1 ↔ DUAL 2	DUAL 1
	Mono	MONO	Automatic change
Stereo	MONO ↔ STEREO		
NICAM Stereo	Dual		DUAL 1

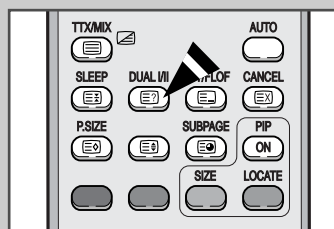

- ◆ If the receiving conditions deteriorate, listening will be easier if the mode is set to the **MONO**.
- ◆ If the stereo signal is weak and an automatic switching occurs, then switch to the **MONO**.

Viewing the Picture In Picture (PIP)

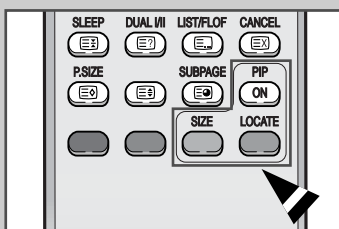
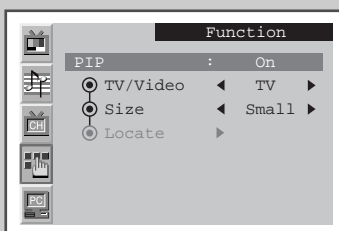
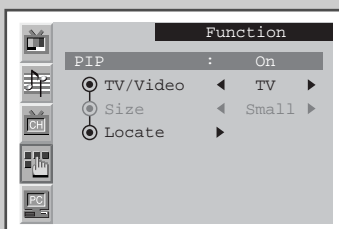
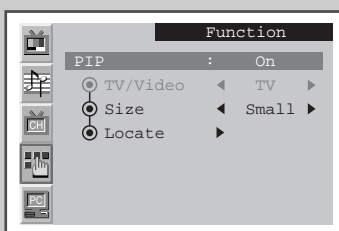
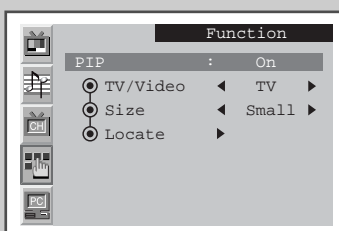
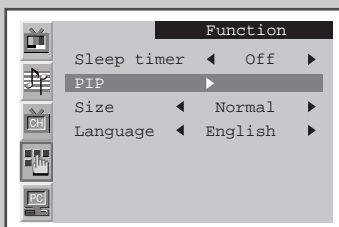

You can display a sub picture within the main picture of TV program or external A/V devices such as VCR or DVD. In this way you can watch TV program or monitor the video input from any connected devices while watching TV or other video input.

- 1 Press the **MENU** button.
Result: The main menu is displayed.

- 2 Press the **P▼** or **P▲** button to select the **Function**.
Result: The options available in the **Function** group are displayed.

- 3 Press the **◀-** or **▶+** button.

- 4 Press the **P▼** or **P▲** button to select the **PIP**. Press the **◀-** or **▶+** button.
Result: The options available in the **PIP** group are displayed.

- 5 Select the **On** by pressing the **◀-** or **▶+** button.
➤ You can also activate the PIP simply by pressing the **PIP ON** button.

- 6 Press the **P▼** or **P▲** button to select the **TV/Video**. Select a source of the sub picture by pressing the **◀-** or **▶+** button.
Result: The sources are displayed in the following order:
TV - VIDEO1 - VIDEO2 - S-VIDEO.

- 7 Press the **P▼** or **P▲** button to select the **Size**. Select a size of the sub picture by pressing the **◀-** or **▶+** button.
Result: The sizes are displayed in the following order:
Small - Medium - Large.
➤ ♦ You can also select these options simply by pressing the **SIZE** button.
♦ Not Available in PC mode.

- 8 Press the **P▼** or **P▲** button to select the **Locate**. Move the sub picture counterclockwise by pressing the **◀-** or **▶+** button.
➤ You can also move the sub picture simply by pressing the **LOCATE** button.

Switching Off Automatically

You can select a time period of between 10 and 240 minutes after your set automatically switches off.

- 1 Press the **MENU** button.
Result: The main menu is displayed.
- 2 Press the **P▼** or **P▲** button to select the **Function**.
Result: The options available in the **Function** group are displayed.
- 3 Press the **◀-** or **▶+** button.
Result: The **sleep timer** is selected.
- 4 Select the number of minutes after which your set switches off by pressing the **◀-** or **▶+** button repeatedly.
 - ◆ The preset time intervals: 10, 20, 30, 60, 90, 120, 150, 180, 210, and 240 minutes.

➤ You can also select simply by pressing the “SLEEP” button.

If the sleep timer is already set, the screen displays the remaining time and then your set will be switched off.
If the sleep timer is not yet set, displays **OFF**.

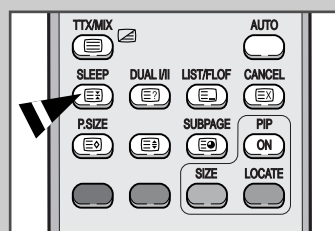
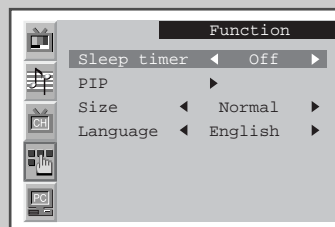

Displaying Information

You can view the setting status of selected source by pressing the “DISPLAY” button on the remote control. The displayed information are different depending on the selected source.

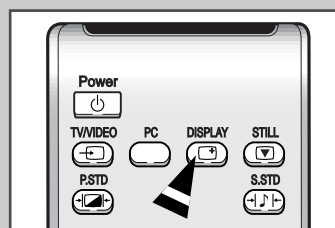

Setting up Your PC Software (Based on Widows 98)

The Windows display-settings for a typical computer are shown below. But the actual screens on your PC will probably be different, depending upon your particular version of Windows and your particular video card. But even if your actual screens look different, the same, basic set-up information will apply in almost all cases. (If not, contact your computer manufacturer or Samsung Dealer.)

- 1 First, click on **"Settings"** on the Windows start menu.

While **"Settings"** is highlighted, move the cursor so that **"Control Panel"** is highlighted.

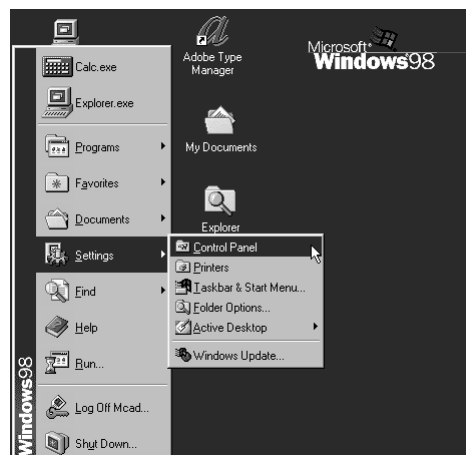

- 2 When the control panel screen appears, click on **"Display"** and a display dialog-box will appear.



- 3 Navigate to the **"Settings"** tab on the display dialog-box.

The correct setting of size (resolution)

- 15" : 1024 x 768 pixels
- 17" : 1280 x 1024 pixels

If a vertical-frequency option exists on your display settings dialog box, the correct value is **"60"** or **"60 Hz"**. Otherwise, just click **"OK"** and exit the dialog box.



Adjusting the Brightness and Contrast

➤ Preset to the PC mode by pressing the **PC** button.

- 1 Press the **MENU** button.
Result: The main menu is displayed.
- 2 Press the **P▼** or **P▲** button to select the **PC**.
Result: The options available in the **PC** group are displayed.
- 3 Press the **▲-** or **▲+** button.
Result: The **Image** is selected.
- 4 Press the **▲-** or **▲+** button again.
Result: The options available in the **Image** group are displayed.
- 5 Select the option (**Brightness** or **Contrast**) to be adjusted for the color of your computer image by pressing the **P▼** or **P▲** button. Press the **▲-** or **▲+** button.
Result: The horizontal bar is displayed.
- 6 Press the **▲-** or **▲+** button to reach the required setting.

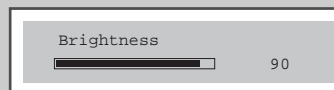
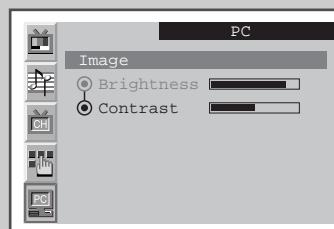
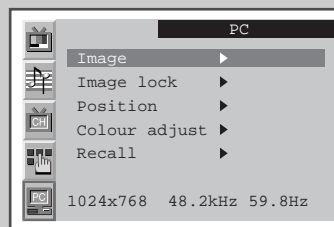

Adjusting the Image Quality

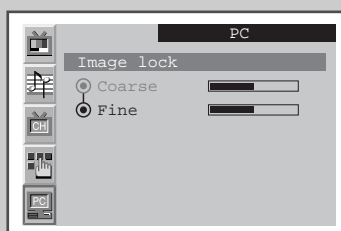
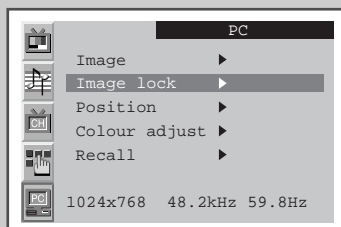

- Preset to the PC mode by pressing the **PC** button.

This feature is used to fine tune and get the best image by removing noises that create unstable images with jitters and shimmers.

- 1 Press the **MENU** button.
Result: The main menu is displayed.
- 2 Press the **P▼** or **P▲** button to select the **PC**.
Result: The options available in the **PC** group are displayed.
- 3 Press the **◀-** or **▶+** button.
- 4 Press the **P▼** or **P▲** button to select the **Image Lock**. Press the **◀-** or **▶+** button.
Result: The options available in the **Image Lock** group are displayed.
- 5 Select the option (**Coarse** or **Fine**) to be adjusted for the quality of your computer image by pressing the **P▼** or **P▲** button. Press the **◀-** or **▶+** button.
Result: The horizontal bar is displayed.
- 6 Press the **◀-** or **▶+** button to reach the required setting.

- This feature may change the width of the image. If necessary, adjust the position to center.

Changing the Image Position

➤ Preset to the PC mode by pressing the **PC** button.

- 1 Press the **MENU** button.
Result: The main menu is displayed.
- 2 Press the **P▼** or **P▲** button to select the **PC**.
Result: The options available in the **PC** group are displayed.
- 3 Press the **▲-** or **▲+** button.
- 4 Press the **P▼** or **P▲** button to select the **Position**. Press the **▲-** or **▲+** button.
- 5 Select the position (**H-Position** or **V-Position**) to be adjusted by pressing the **P▼** or **P▲** button. Press the **▲-** or **▲+** button.
Result: The horizontal bar is displayed.
- 6 Press the **▲-** or **▲+** button to reach the required setting.

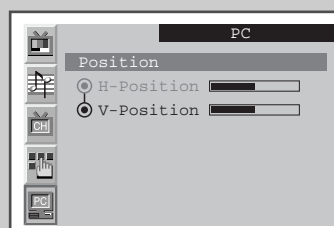
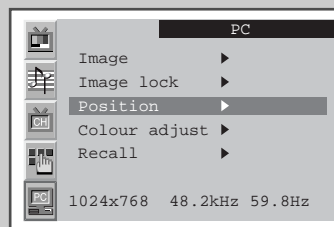

Adjusting the Color

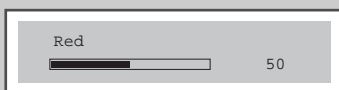
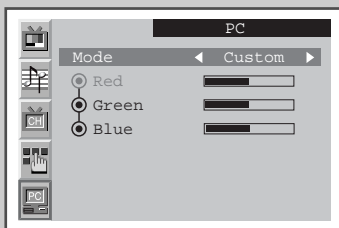
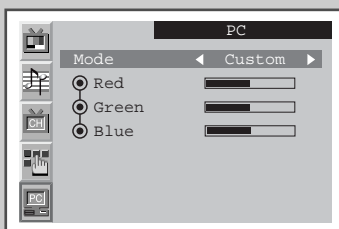
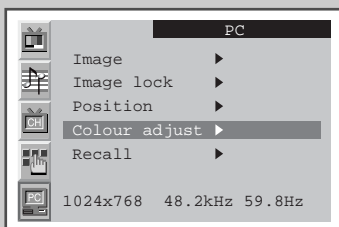

➤ Preset to the PC mode by pressing the **PC** button.

1 Press the **MENU** button.

Result: The main menu is displayed.

2 Press the **P▼** or **P▲** button to select the **PC**.

Result: The options available in the **PC** group are displayed.

3 Press the **◀-** or **▶+** button.

4 Press the **P▼** or **P▲** button to select the **Colour adjust**. Press the **◀-** or **▶+** button.

Result: The options available in the **Colour adjust** group are displayed with the **Mode** is selected.

5 Select the required color mode by pressing the **◀-** or **▶+** button repeatedly. The following color modes are available:

Custom – **Colour 1** – **Colour 2** – **Colour 3**.

6 If you wish adjust the color which best corresponds to your viewing requirements, select the option (**Red**, **Green**, or **Blue**) to be adjusted by pressing the **P▼** or **P▲** button. Press the **◀-** or **▶+** button.

Result: The horizontal bar is displayed.

7 Press the **◀-** or **▶+** button to reach the required setting.

➤ If you change the **Red**, **Green**, or **Blue** settings, the **Mode** is selected to **Custom** automatically.

Initializing the Image Settings

➤ Preset to the PC mode by pressing the **PC** button.

You can replace all image settings with the factory default values.

- 1 Press the **MENU** button.
Result: The main menu is displayed.
- 2 Press the **P▼** or **P▲** button to select the **PC**.
Result: The options available in the **PC** group are displayed.
- 3 Press the **◀-** or **▶+** button.
- 4 Press the **P▼** or **P▲** button to select the **Recall**. Press the **◀-** or **▶+** button.
Result: The options available in the **Recall** group are displayed.
- 5 Select the option (**Image recall** or **Color recall**) to be replaced by pressing the **P▼** or **P▲** button. Press the **◀-** or **▶+** button.
Result: The screen becomes black and return to original view about a few seconds later.

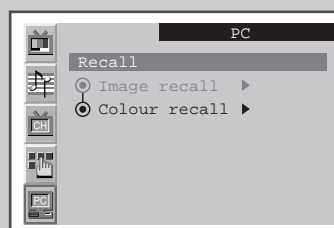

Teletext Feature

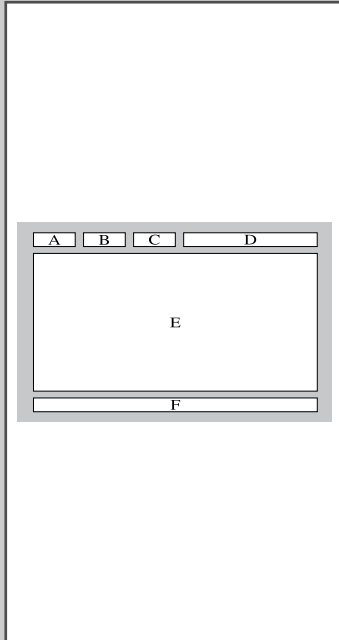

Most television channels provide written information services via teletext. Information provided includes:

- ◆ *Television programme times*
- ◆ *News bulletins and weather forecasts*
- ◆ *Sports results*
- ◆ *Travel information*

This information is divided into numbered pages (see diagram).

Part	Contents
A	Selected page number.
B	Broadcasting channel identity.
C	Current page number or search indications.
D	Date and time.
E	Text.
F	Status information. FASTEXT information.

- Teletext information is often divided between several pages displayed in sequence, which can be accessed by:
- ◆ Entering the page number
 - ◆ Selecting a title in a list
 - ◆ Selecting a coloured heading (FASTEXT system)

Displaying the Teletext Information

You can display Teletext information at any time on your set.

- ☞ For Teletext information to be displayed correctly, channel reception must be stable; otherwise:
 - ◆ Information may be missing
 - ◆ Some pages may not be displayed

- 1 Select the channel providing the Teletext service using the **P▼** or **P▲** button.
- 2 Press the **TTX/MIX** button to activate the teletext mode.
Result: The contents page is displayed. It can be redisplayed at any time by pressing the **(Ei)** (index) button.
- 3 If you wish to display the actual broadcast at the same time as the teletext page, press the **TTX/MIX** button again.
- 4 To return to normal viewing, press the **CANCEL (EX)** button.
- 5 Press the **EXIT** button again to exit from the teletext display.

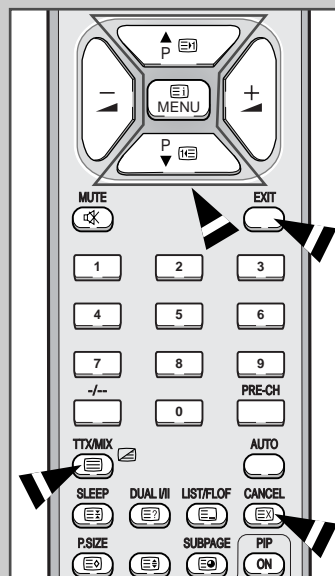

Selecting a Page by Number

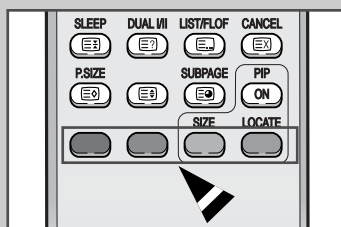
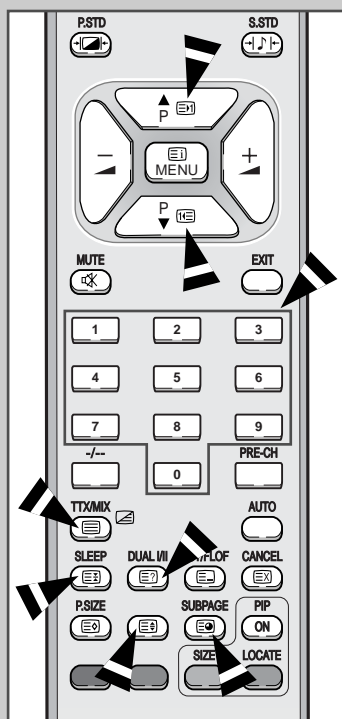

You can enter the page number directly by pressing the numeric buttons on the remote control.

- 1 Enter the three-digit page number given in the content by pressing the corresponding numeric buttons.
Result: The current page counter is incremented and the page is then displayed.
- 2 If the selected page is linked with several secondary pages, the secondary pages are displayed in sequence. To freeze the display on a given page, press the (hold) button. Press the (hold) button again to resume.

Using the various display options:

To display...	Press the...
◆ Hidden text (answers to quiz games, for example)	(reveal)
◆ The normal screen	(reveal) again
◆ A secondary page, by entering its 4-digit number	SUBPAGE ()
◆ The next page	(page up)
◆ The previous page	(page down)
◆ Double-size letters in the: <ul style="list-style-type: none"> • Upper half of the screen • Lower half of the screen 	(size) <ul style="list-style-type: none"> • Once • Twice
◆ Normal screen	• Three times

Using FLOF to Select a Page

The various topics included in the teletext pages are color-coded, and can be selected by pressing the colored buttons on the remote control.

- 1 Display the teletext contents page by pressing the **TTX/MIX** button.
- 2 Press the coloured button corresponding to the topic that you wish to select; the available topics are given on the status line.
Result: The page is displayed with other coloured information that can be selected in the same way.
- 3 To display the previous or next page, press the corresponding coloured button.
- 4 To display the subpage, see the following steps.
 - ◆ Press the **SUBPAGE** (P) button.
Result: The available subpages appear.
 - ◆ Select the required sub-page. Sub-pages can be scrolled by using the (←) or (→) button.

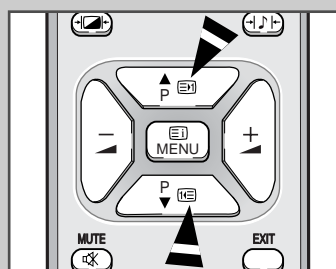
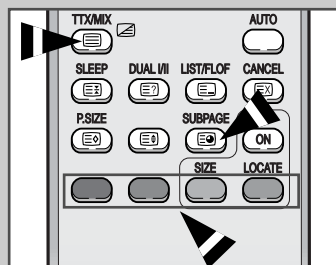

Storing Teletext Pages

You can store up to four teletext pages to display them later at leisure.

- 1 Select the LIST mode using the **LIST/FLOF** (E) button.
Result: Four 3-digit numbers are displayed in different colors.
 ➤ The **LIST/FLOF** (E) button is used to switch between the LIST and FLOF modes.
- 2 Press the colored button corresponding to the page that will be replaced.
- 3 Enter the new page number using the numeric buttons.
- 4 Repeat steps 2 and 3 for each page to be stored, using a different colored button each time.
- 5 Press the (E) (store) button until the corresponding blocks blink.

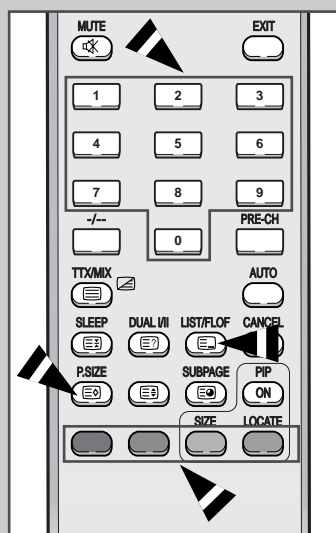

Troubleshooting: Before Contacting Service Personnel

Before contacting Samsung after-sales service, perform the following simple checks.

If you cannot solve the problem using the instructions below, note the model and serial number of your set and contact your local dealer.

No sound or picture	<ul style="list-style-type: none"> ◆ Check that the mains lead has been connected to a wall socket. ◆ Check that you have pressed the Power (⏻) button. ◆ Check the picture contrast and brightness settings. ◆ Check the volume.
Normal picture but no sound	<ul style="list-style-type: none"> ◆ Check the volume. ◆ Check whether the MUTE button has been pressed on the remote control.
No picture or black and white picture	<ul style="list-style-type: none"> ◆ Adjust the color settings. ◆ Check that the broadcast system selected is correct.
Sound and picture interference	<ul style="list-style-type: none"> ◆ Try to identify the electrical appliance that is affecting the set and move it further away. ◆ Plug your set into a different mains socket.
Blurred or snowy picture, distorted sound	<ul style="list-style-type: none"> ◆ Check the direction, location and connections of your aerial. This interference is often due to the use of an indoor aerial.
Remote control malfunctions	<ul style="list-style-type: none"> ◆ Replace the remote control batteries. ◆ Clean the upper edge of the remote control (transmission window). ◆ Check the battery terminals.
"Check Signal Cable" message is displayed.	<ul style="list-style-type: none"> ◆ Check that the signal cable is firmly connected to the PC or video sources. ◆ Check that the PC or video sources are turned on.
On PC mode, "Not Supported Mode" message is displayed.	<ul style="list-style-type: none"> ◆ Check the maximum resolution and the frequency of the video Adapter. ◆ Compare these values with the data in the Display Modes Timing Chart.
On PC mode, horizontal or vertical bars appear to flicker, jitter or shimmer on the image.	<ul style="list-style-type: none"> ◆ Adjust the Coarse or Fine function.
On PC mode, screen is black and power indicator light is steady amber or blinks every 0.5 or 1 seconds.	<ul style="list-style-type: none"> ◆ The TV is using its power management system. ◆ Move the computer's mouse or press a key on the keyboard.

continued...

Troubleshooting: Before Contacting Service Personnel

On PC mode, image is not stable and may appear to vibrate.

- ◆ Check that the display resolution and frequency from your computer or video board is an available mode for your set. On your computer check: Control Panel, Display, Settings.
- ◆ If the setting is not correct, use your computer utility programme to change the display settings.

➤ Your set supports multiscan display functions within the following frequency domain:

Horizontal frequency -	15" : 30 ~ 69 kHz
	17" : 30 ~ 81 kHz
Vertical frequency -	56 ~ 75 Hz
Maximum refresh rate -	15" : 1024 x 768 @ 75Hz
	17" : 1280 x 1024 @ 75Hz

On PC mode, image is not centered on the screen.

- ◆ Adjust the horizontal and vertical position.

You need the Monitor driver software.

- ◆ Download the driver from WWW pages:
<http://www.samsungusa.com/monitor>
<http://www.samsung-monitor.com>

Power Saver

This set has a built-in power management system called PowerSaver. This system saves energy by switching your set into a low-power mode when it has not been used for a certain period of time. The available modes are "On", "Standby", "Sleep", and "Deep Sleep". PowerSaver operates with a VESA DPMS compliant video card installed in your computer. You use a software utility installed on your computer to set up this feature.

State	Normal Operation	Power-Saving Function mode (EPA/NUTEK)
Horizontal Sync	Active	Inactive
Vertical Sync	Active	Inactive
Power Indicator	Green	Green, Blinking (1 sec interval)
Power Consumption	LW15E23CB : 48W (Max.) LW17E24CB : 58W (Max.)	Less than 2W

- *This set automatically returns to normal operation when horizontal and vertical sync return. This occurs when you move the computer's mouse or press a key on the keyboard.*

Technical and Environmental Specifications

Model	LW15E23CB	LW17E24CB
Panel		
Size	15" Diagonal	17" Diagonal
Display Size	304.1(H) x 228.1(V) mm	338(H) x 270(V) mm
Type	a-si TFT active matrix	
Pixel Pitch	0.297 (H) x 0.297 (V) mm	
Viewing Angle	70/70/55/60 (L/R/U/D)	70/70/55/55 (L/R/U/D)
Frequency		
Horizontal	30 ~ 69 kHz	30 ~ 81 kHz
Vertical	56 ~ 75 Hz	56 ~ 75 Hz (XGA) / 60 ~ 75 Hz (SXGA)
Display Color	16,777,216 colors	
Display Resolution		
Optimum Mode	1024 x 768 @ 60 Hz	1280 x 1024 @ 60 Hz
Maximum Mode	1024 x 768 @ 75 Hz	1280 x 1024 @ 75 Hz
Input Signal		
Sync.	H/V Separate, TTL, P. or N.	
Video Signal	0.7 Vp-p @ 75 ohm	
Power Supply		
Input	AC 90 ~ 264V, 1.0 ~ 0.5A (50Hz / 60Hz)	
Output	DC 14V/3A	DC 14V/3.5A
Power Consumption		
Maximum	48 W	58 W
Power Saving	< 2 W	
Dimensions (W x D x H) / Weight		
TV Body	474 x 51 x 317 mm / 3.27 kg	530 x 57 x 367 mm / 4.25 kg
With Stand	474 x 204 x 397 mm / 3.97 kg	530 x 204 x 447 mm / 4.95 kg
Environmental Considerations		
Operating Temperature	50 °F to 104 °F (10 °C to 40 °C)	
Operating Humidity	10% to 80%	
Storage Temperature	- 13 °F to 113 °F (-25 °C to 45 °C)	
Storage Humidity	5% to 95%	
Audio Characteristics		
Audio Input 1	RCA Jack (L, R), 0.5Vrms (-9dB)	
Audio Input 2 (PC)	3.5Ø Stereo Jack, 0.5Vrms (-9dB)	
Headphone Output	Max. 10mW Output (3.5Ø Stereo Jack, 32Ω)	
Frequency	RF: 80Hz ~ 15kHz (at- 3dB)	
Response	A/V: 80Hz ~ 20kHz (at- 3dB)	

Display Modes

If the signal from the system equals to the standard signal mode, the screen is adjusted automatically. If the signal from the system doesn't equal to the standard signal mode, adjust the mode with referring to the Video card user guide because the screen might not display or only the power LED might be on. For the display modes listed below, the screen image has been optimized during manufacture.

Mode	Resolution	Horizontal Frequency (kHz)	Vertical Frequency (Hz)	Pixel Clock Frequency (MHz)	Sync Polarity (H/V)
VGA	720 x 400	31.469	70.087	28.322	- / +
	640 x 480	31.469	59.940	25.175	- / -
	640 x 480	37.500	75.000	31.500	- / -
SVGA	800 x 600	46.875	75.000	49.500	+ / +
XGA	1024 x 768	48.363	60.004	65.000	- / -
	1024 x 768	60.023	75.029	78.750	+ / +
SXGA (LW17E24CB)	1280 x 1024	63.981	60.020	108.000	+ / -, + / -
	1280 x 1024	79.976	75.025	135.000	+ / +

Maintenance of Your Television

To avoid risk of electric shock, do not disassemble the TV cabinet (except for gaining access to the cable connectors as described on page 7). Users cannot service the TV. User maintenance is restricted to cleaning as explained below:

Unplug the television from the power outlet before cleaning.

- ◆ When you clean the TFT-LCD and the panel outside, please apply the recommended small amount of cleaner by using soft and dry cloth and polish it. Let your television screen not to be forced but to be scrubbed out softly. If excessive force is applied, you can have a stain on it.
- ◆ Never use flammable cleaning material to clean your television or any other electrical apparatus.

Wiring the Mains Power Supply Plug (UK Only)

◆ **IMPORTANT NOTICE**

The mains lead on this equipment is supplied with a moulded plug incorporating a fuse. The value of the fuse is indicated on the pin face of the plug and, if it requires replacing, a fuse approved to BS11362 of the same rating must be used. Never use the plug with the fuse cover omitted if the cover is detachable. If a replacement fuse cover is required, it must be of the same color as the pin face of the plug. Replacement covers are available from your dealer. If the fitted plug is not suitable for the power points in your house or the cable is not long enough to reach a power point, you should obtain a suitable safety approved extension lead or consult your dealer for assistance. However, if there is no alternative to cutting off the plug, remove the fuse and then safely dispose of the plug. Do NOT connect the plug to a mains socket as there is a risk of shock hazard from the bared flexible cord.

◆ **IMPORTANT**

The wires in the mains lead are colored in accordance with the following code:

BLUE - NEUTRAL BROWN - LIVE

As these colors may not correspond to the colored markings identifying the terminals in your plug, proceed as follows:

The wire colored BLUE must be connected to the terminal marked with the letter N or colored BLUE or BLACK. The wire colored BROWN must be connected to the terminal marked with the letter L or colored BROWN or RED.

WARNING: DO NOT CONNECT EITHER WIRE TO THE EARTH TERMINAL, WHICH IS MARKED WITH THE LETTER E OR BY THE EARTH SYMBOL \perp , OR COLORED GREEN OR GREEN AND YELLOW.

Memo

– AFTER SALES SERVICE

- Do not hesitate to contact your retailer or service agent if a change in the performance of your product indicates that a faulty condition may be present.

