

# RCA

## LCD TV

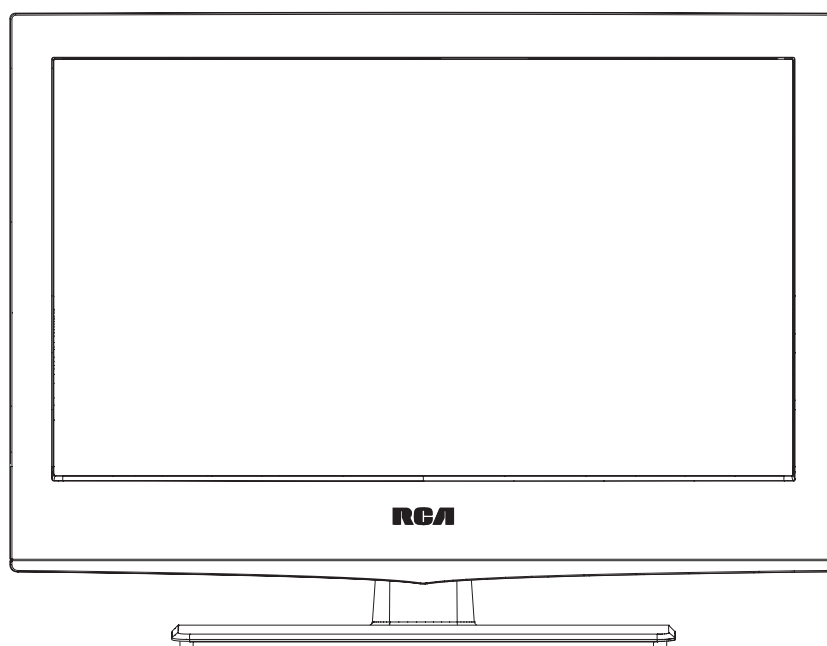

## RLC3209

### IMPORTANT

Please read this manual carefully before installing and operating the TV  
Keep this manual handy for further reference

# Table of Contents

<b>Caution</b> .....	<b>2</b>	<b>OSD</b> .....	<b>13</b>
<b>Important Safety Precautions</b> .....	<b>3</b>	Language	
<b>Desktop TV Bracket Installation &amp; Assembly</b> .....	<b>4</b>	H-Position	
<b>Front/Back panel diagram</b> .....	<b>5</b>	V-Position	
<b>Remote Controller</b> .....	<b>6</b>	Duration	
Battery Installation		Halftone	
Using the Remote Control		MEM-RECALL	
<b>Install TV</b> .....	<b>7</b>	<b>CHANNEL</b> .....	<b>13</b>
Set your TV		Auto Scan	
Connect Antenna and power		Fine Tuning	
Turn On TV		Add/Erase	
<b>Systems Connection</b> .....	<b>8-10</b>	Source	
AV Input		<b>PIP</b> .....	<b>13</b>
S-Video Input		Multi Window	
PC Input		Sub Source	
HDMI Input		Size	
Y Pb Pr Input		Border Color	
EARPHONE Output		Sound Source	
<b>PICTURE</b> .....	<b>11</b>	Swap	
Picture Mode		PIP Position	
Contrast		<b>PC</b> .....	<b>14</b>
Brightness		Picture Mode	
HUE		Contrast	
Saturation		Brightness	
Sharpness		Color Temp	
Color Temp		Scale Mode	
Scale Mode		Auto Adjust	
3D NR		<b>GEOMETRY</b> .....	<b>14</b>
MPGE NR		Auto Adjust	
<b>SOUND</b> .....	<b>11</b>	H Position	
Sound Mode		V Position	
Bass		Clock	
Treble		Phase	
Balance		<b>SOURCE</b> .....	<b>15</b>
AVC		<b>RESOLUTION</b> .....	<b>15</b>
Audio only		<b>NICAM</b> .....	<b>15</b>
<b>ADVANCE</b> .....	<b>11-12</b>	<b>HELP</b> .....	<b>16</b>
Sleep Timer		<b>SPECIFICATIONS</b> .....	<b>17</b>
TTX Language			
Auto Format			

# Caution



The lightning flash with arrowhead symbol, within an equilateral triangle is intended to alert the user to the presence of un-insulated "dangerous voltage" within the products enclosure that may be of sufficient magnitude to constitute a risk of electric shock to the persons.



The exclamation point within an equilateral triangle is intend to alert the user to the presence of important operating and maintenance (servicing) instructions in the literature accompanying the appliance.

## **Correct disposal of this Product**

Waste Electrical & Electronic Equipment (WEEE)



Your product is designed and manufactured with high quality materials and components which can be recycled and reused.

This symbol means that electrical and electronic equipment, at their end-of-life, should be disposed of separately from your household waste.

Please dispose of this equipment at your local community waste collection/recycling centre.

In the European Union there are separate collection systems for used electrical and electronic products. Please help us to conserve the environment we live in!

# Important Safety Precautions

- 1) Read these instructions.
- 2) Keep these instructions.
- 3) Heed all warnings.
- 4) Follow all instructions.
- 5) Do not use this apparatus near water.
- 6) Clean only with dry cloth.
- 7) Do not block any ventilation openings. Install in accordance with the manufacturer's instructions.
- 8) Do not install near any heat sources such as radiators, heat registers, stoves, or other apparatus (including amplifiers) that produce heat.
- 9) Do not defeat the safety purpose of the polarized or grounding-type plug. A polarized plug has two blades with one wider than the other. A grounding type plug has two blades and a third grounding prong. The wide blade or the third prong are provided for your safety, If the provided plug does not fit into your outlet, consult an electrician for replacement of the obsolete outlet.
- 10) Protect the power cord from being walked on or pinched particularly at Plugs, convenience receptacles, and the point where they exit from the apparatus.
- 11) Only use attachments /accessories specified by the manufacturer.
- 12) Use only with the cart, stand, tripod, bracket, or table specified by the manufacturer, or sold with the apparatus. When a cart is used caution when moving the cart/apparatus combination to avoid injury tip-over.



- 13) Unplug this apparatus during lightning storms or when unused for long periods of time.

## Caution:

- 14) To reduce the risk of fire or electric shock, do not expose this apparatus to rain or moisture.
- 15) The apparatus shall be disconnected from the mains by placing the power/standby switch in the standby position and unplugging the power cord of the apparatus from the AC mains receptacle.
- 16) The socket-out shall be installed near the equipment and shall be easily accessible.
- 17) This product should never be placed in a built-in installation such as a bookcase or rack unless proper ventilation is provided or the manufacture's instructions have been adhered to.
- 18) The apparatus shall not be exposed to dripping or splashing and that no objects filled with liquid, such as vases, shall be placed on the apparatus.
- 19) Do not place any sources of danger on the apparatus (e.g. liquid filled objects, lighted candles).
- 20) Wall or Ceiling Mounting - The appliance should be mounted to a wall or ceiling only as recommended by the manufacturer.

These servicing instructions are for use by qualified service personnel only. To reduce the risk of electric shock do not perform any servicing other than that contained in the operating instructions. unless you are qualified to do so.

# Desktop TV Bracket Installation & Assembly

- 1 First put the TV on the table smoothly and put some soft close on the table to avoid scratching the screen.
- 2 Use the screw driver to take off the 6pcs screws which are fixed on the bottom stand (the direction of the arrow, refer to the figure 1). And take out the bottom stand (please keep the screws and bottom stand carefully)

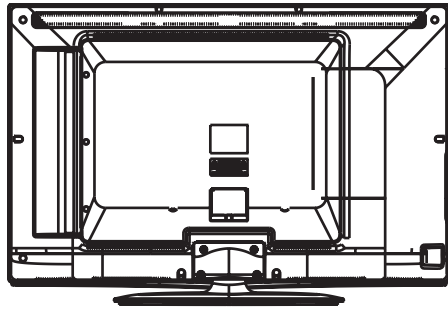

figure 1

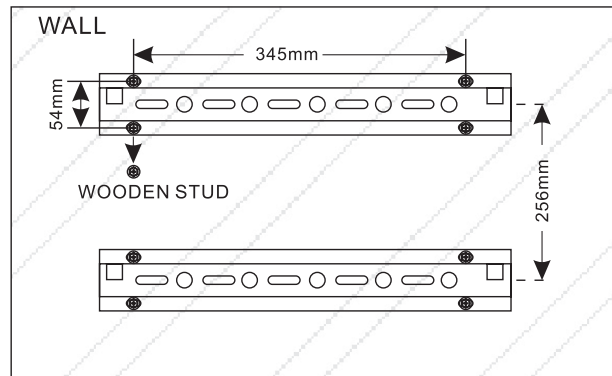

Figure2

3. Mounting steps ( See below figures 1 to 4 for details) :

Step 1: Decide whether or not to use padding behind the wall mount brackets.

Step 2: Locate and fix the wall mount brackets with 8 studs into the wooden part of the plasterboard wall, Details see Figure2.

Step 3: Be sure that the wall mount brackets are level with each other.

Step 4: Hang the unit on the secured wall mount brackets.

To ensure a reliable and sturdy installation, please consult a professional installer before mounting the unit to the wall.

Moreover, the spacers can be used in combination to adjust unit's distance from the wall in order to match the mounted Flat-Panel TV. When using the 1/4", 1/2", 3/4", 1" padding, longer screws must be purchased.

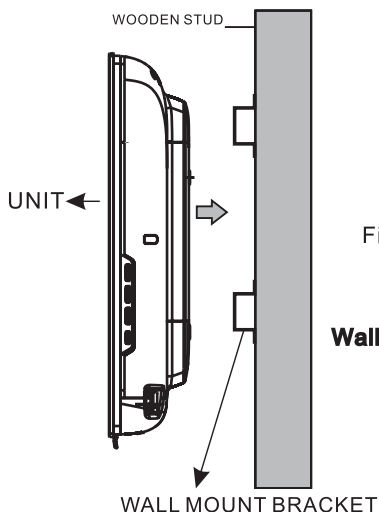

Figure3

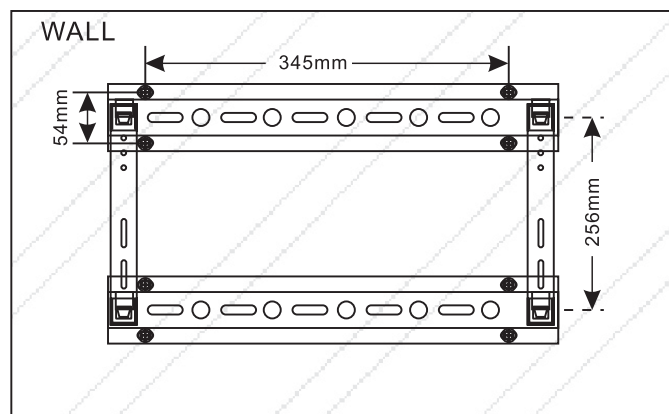
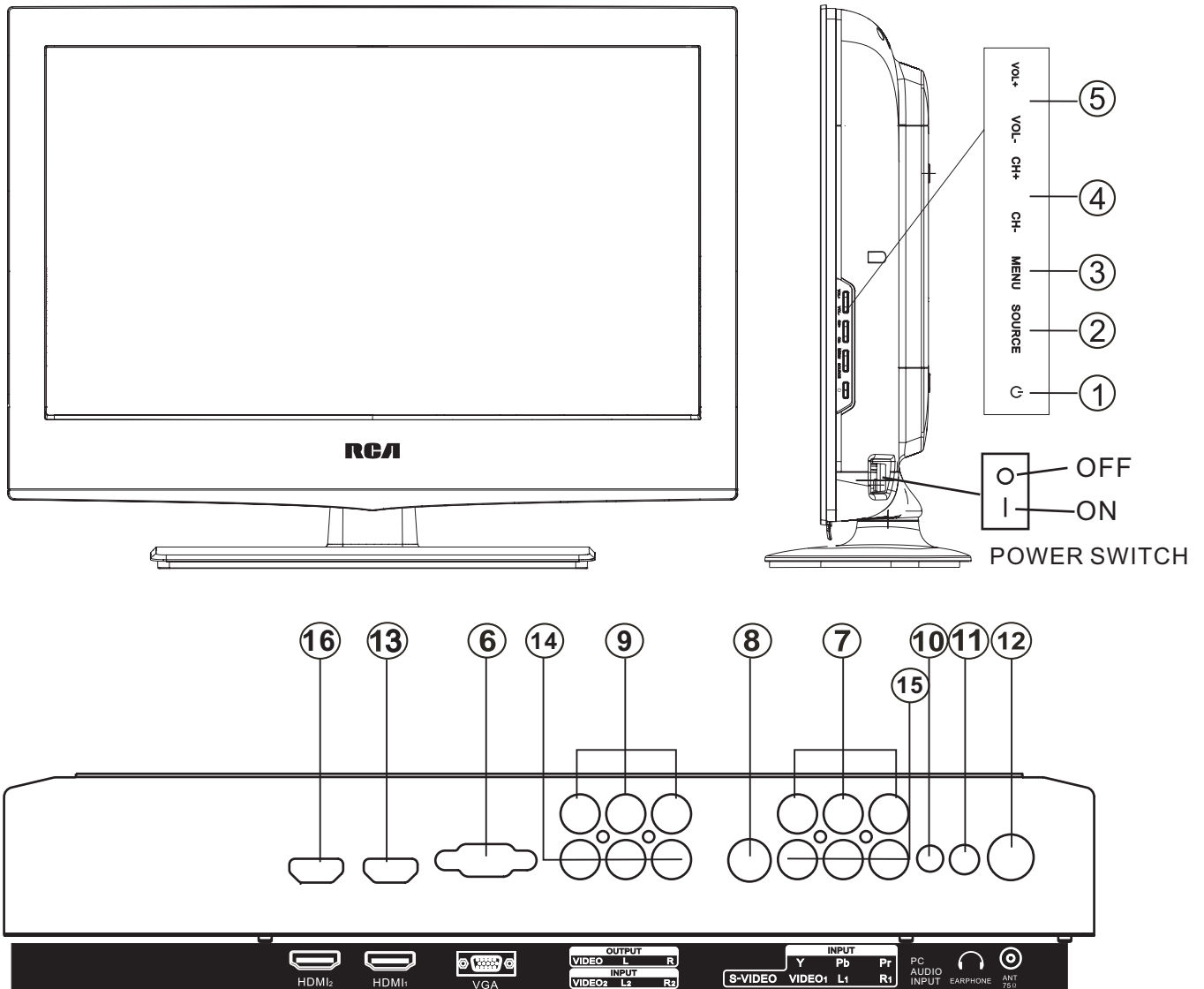

Figure4

Noted:

- 1.The desktop TV bracket is not include
2. We highly recommend using a qualified technician
3. This products can be mount on the plasterboard wall or other wall more better.

# Side panel diagram



1. **⏻**: Turn on/off POWER.
2. **SOURCE**: Source select
3. **MENU**: Into or exit from menu  
(Use CH+/- button select item,  
VOL+/- button adjust item)
4. **CH+/-**: Select channel
5. **VOL+/-**: Adjust Volume
6. **VGA Input**: PC analog signal input
7. **YPbPr**: Color difference  
components input and relevant  
video input
8. **S-VIDEO**: Color and brightness  
difference components input.
9. **AV Output**
10. **VGA/AUDIO**: VGA audio input.
11. **EARPHONE** Output (3.5mm)
12. **ANT 75 ohm**: Connect the antenna to  
the antenna input.
13. **HDMI1 Input**: Digital signal input from  
HDMI video connector
- 14/15. **VIDEO/R/L1/2**: external AV  
signal input and relevant right/left  
sound channel.
16. **HDMI2 Input**

# Remote Controller

1. **POWER** : Sets your TV to power on or standby mode.
2. **MUTE** : Press to mute the sound. Press again or press VOL+ to unmute.
3. **0--9** Press 0~9 to select a TV channel directly while watching TV. The channel will change after 2 seconds. Applicable for entering page number in teletext mode and so on.
4. **↻**: Return to the previously viewed program.
5. **CH +/-** : Press to scan through or to select a channel.
6. **V +/-**: Press to increase / decrease the sound level.
7. **- / - -** Press this button to enter a program number for different digit. eg. - / - - / - - -
8. **DISPLAY** : Press to display the source and channel's info.
9. **(▲ / ▼ / ◀ / ▶ / ENTER )**  
Allows you to navigate the on-screen menus and adjust the system settings to your preference.
10. **SOURCE**: Press to list the source items.
11. **SLEEP**: Select amount of time before TV turn itself off automatically.
12. **EXIT**: Exits from the menu or sub-menu and menus and adjust the system settings to your preference.
13. **MENU** : Allows you to navigate the on-screen menus.
14. **P.MODE**: : Press to cycle through the different picture settings
15. **PIP/POP**: (Picture in picture)  
NO/OFF: Press to On / Off the PIP function .  
SOURCE: Press to cycle the PIP source  
SWAP: PIP/main picture position swap
16. **S.MODE**: Press to cycle through the different sound settings.
17. **MTS**: : Press to select the MTS mode.(for example, Nicam , BTSC, MONO, STEREO .eg )
18. **SCALE**: Press to switch the size of screen.
19. **STILL**: image still.

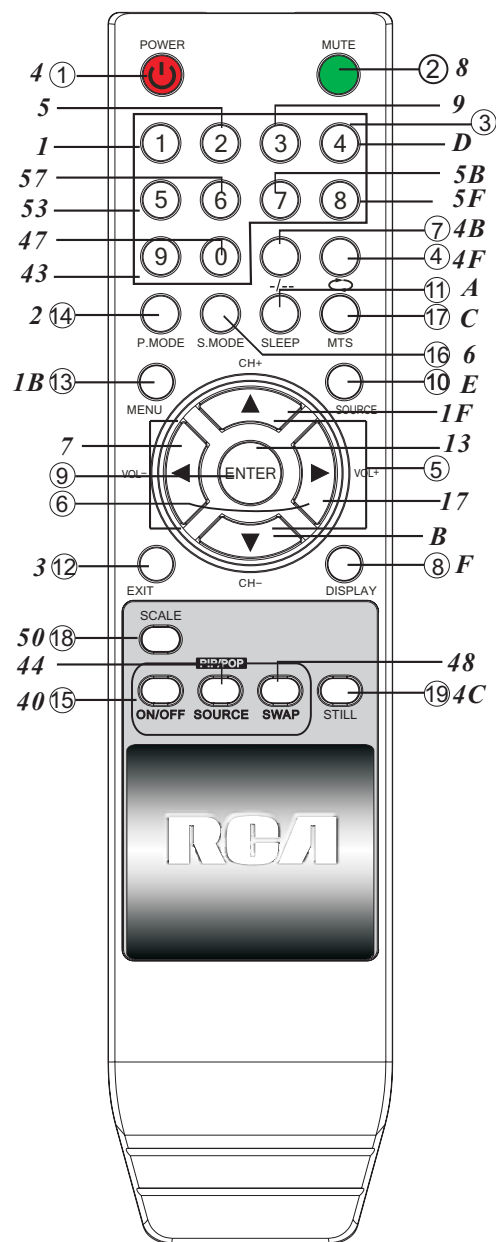

## Battery Installation:

Remove the battery compartment lid on the rear of the remote control. Put two AAA batteries inside the battery compartment with their + and - ends aligned as indicated. Do not mix old and new batteries or different types of batteries. Replace the battery compartment lid. Slide the lid until you hear it click into place.

## Using the Remote Control:

Unless stated otherwise, the remote control can operate all the features of the TV. Always point the remote control directly at the remote sensor in the front of the TV.

**Universal Remote Control code: 007F**

# Install and connect TV

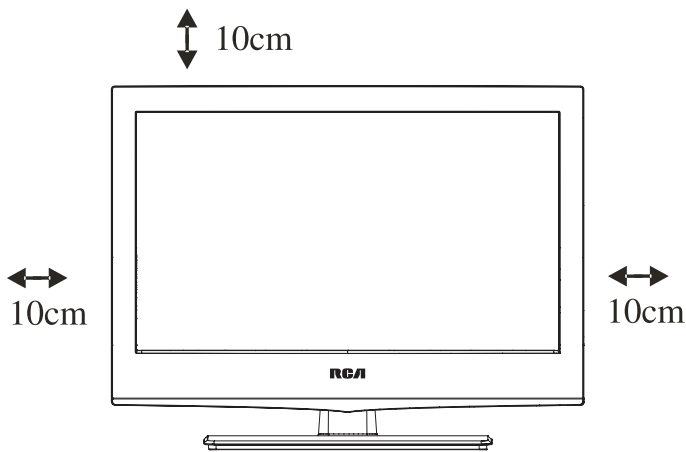

## Set your TV

To put your TV in a firm place which can bear the weight of the TV.

To avoid danger, please don't expose the TV near water or heating place (such as light, candle, heating machine), do not block the ventilation at the back of TV.

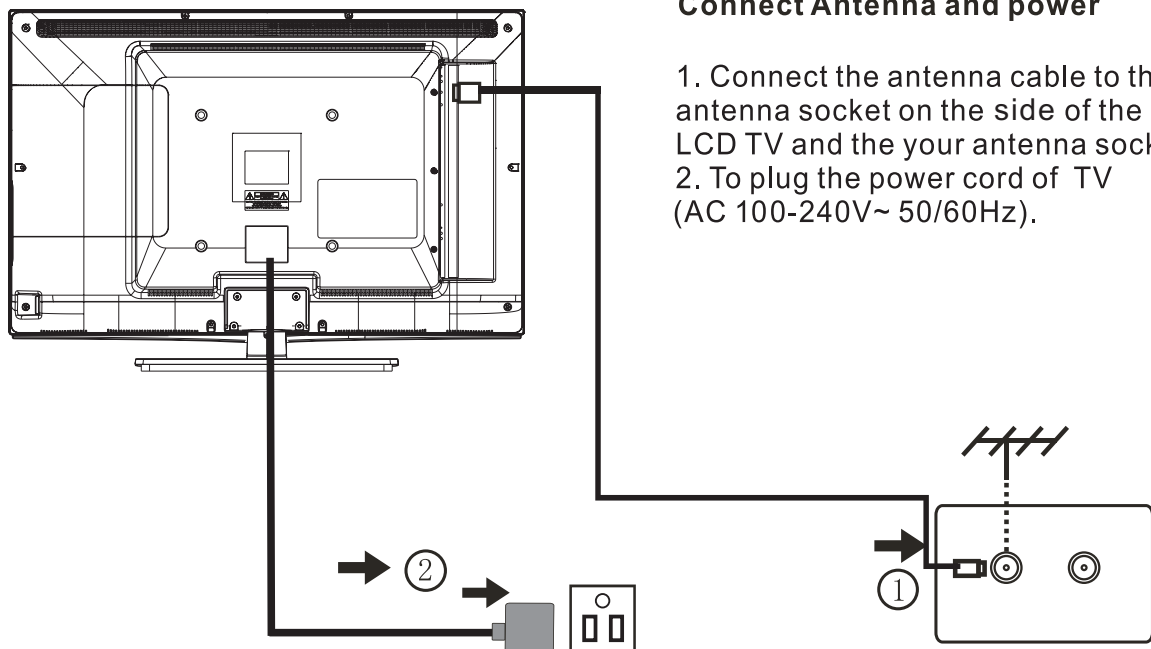

## Connect Antenna and power

1. Connect the antenna cable to the antenna socket on the side of the LCD TV and the your antenna socket.
2. To plug the power cord of TV (AC 100-240V~ 50/60Hz).

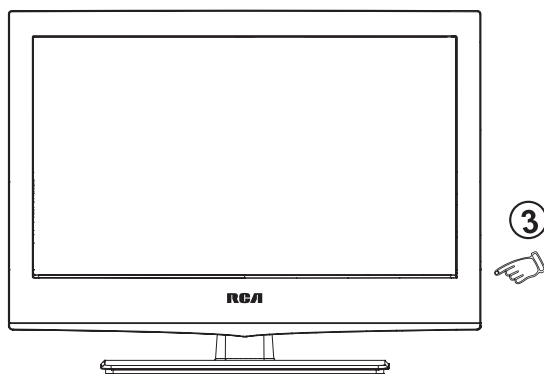

## Turn On TV

3. Press the power button of the TV the indication light will turn to green. If the indicator is in standby mode (the light is red), press the power button on the remote control or top of the TV.

**NOTE** Picture for reference purposes only.



# Systems Connection

## 1. AV INPUT/OUTPUT

Video / Audio input, use the **SOURCE** button select **AV** on the remote control .

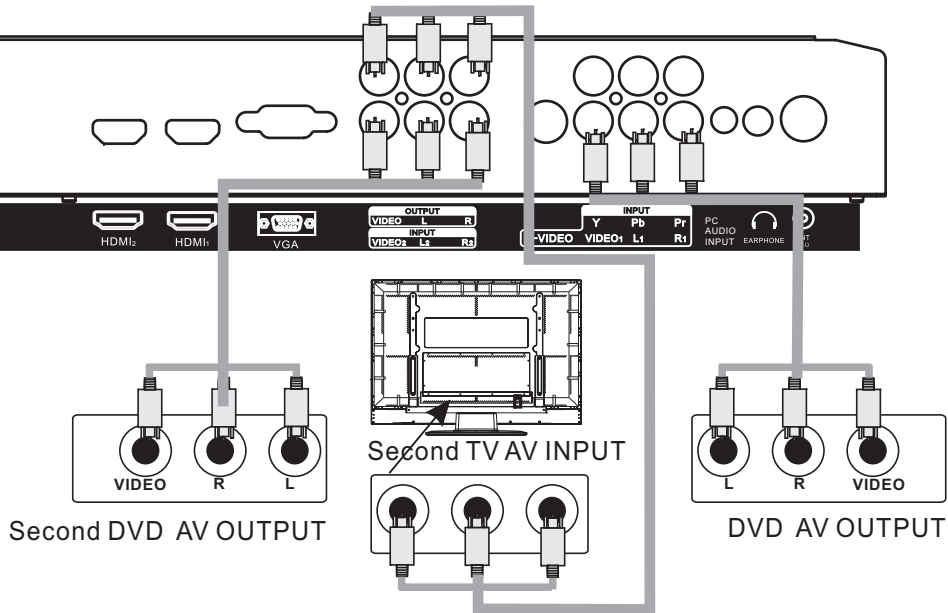

## 2. S-VIDEO INPUT

S-VIDEO input, use the **SOURCE** button select **S-VIDEO** on the remote control .

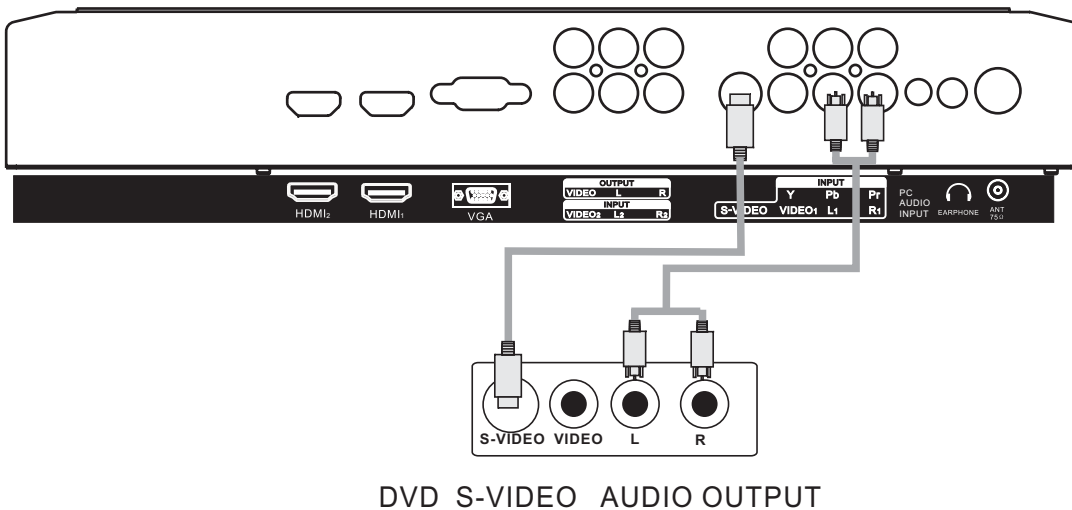

# Systems Connection

## 3. PC INPUT

PC (VGA) input, use the **SOURCE** button select **PC** on the remote control .

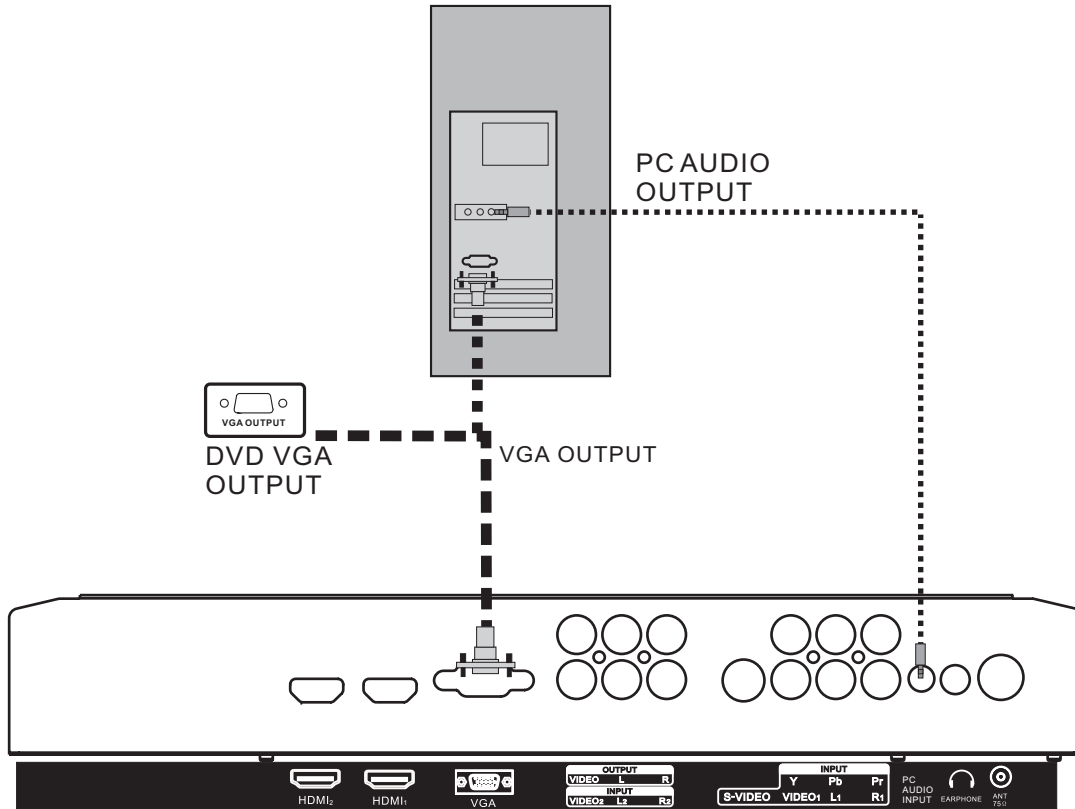

## 4. HDMI INPUT

HDMI input, use the **SOURCE** button select **HDMI** on the remote control .

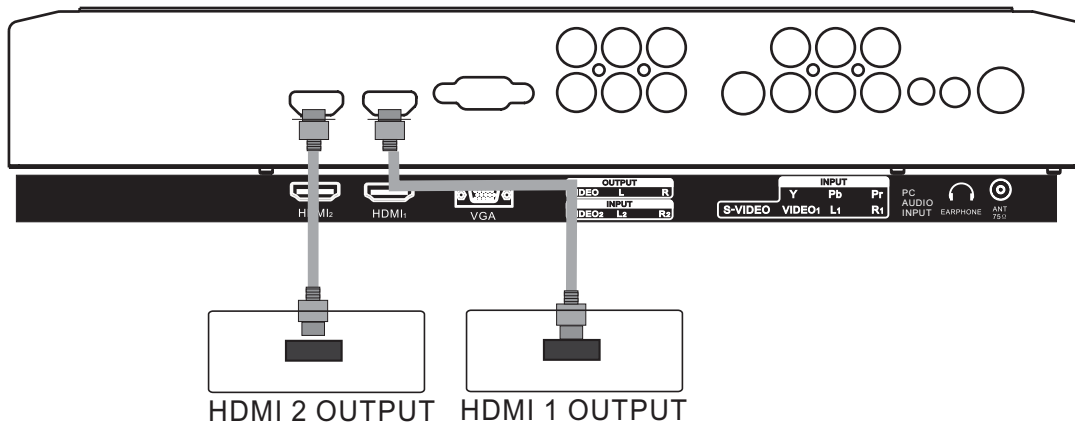

# Systems Connection

## 5. Y Pb Pr Input

Y Pb Pr input, use the **SOURCE** button select **Y Pb Pr** on the remote control.

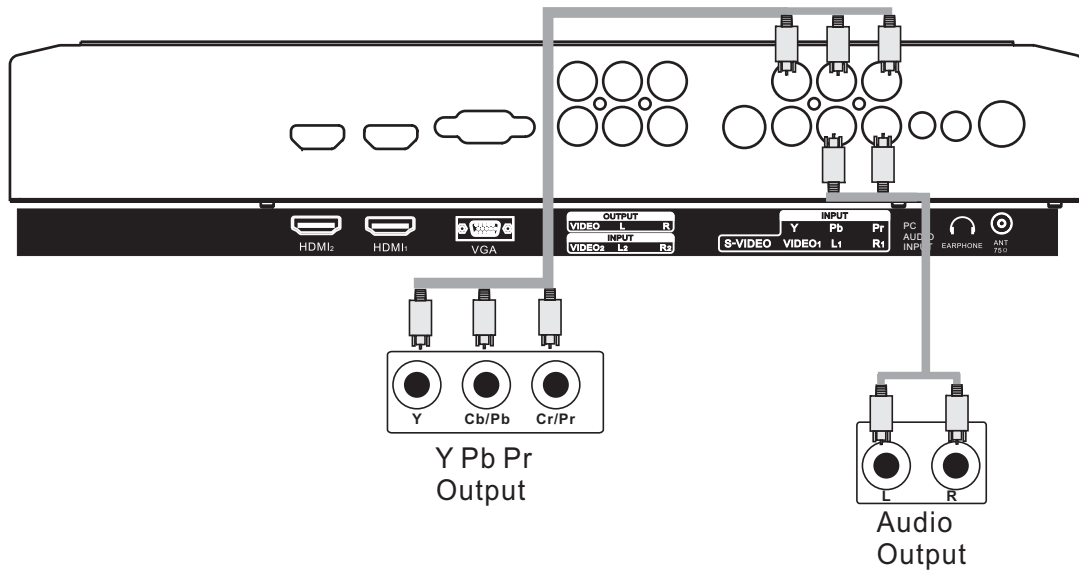

## 6. Earphone Output (optional)

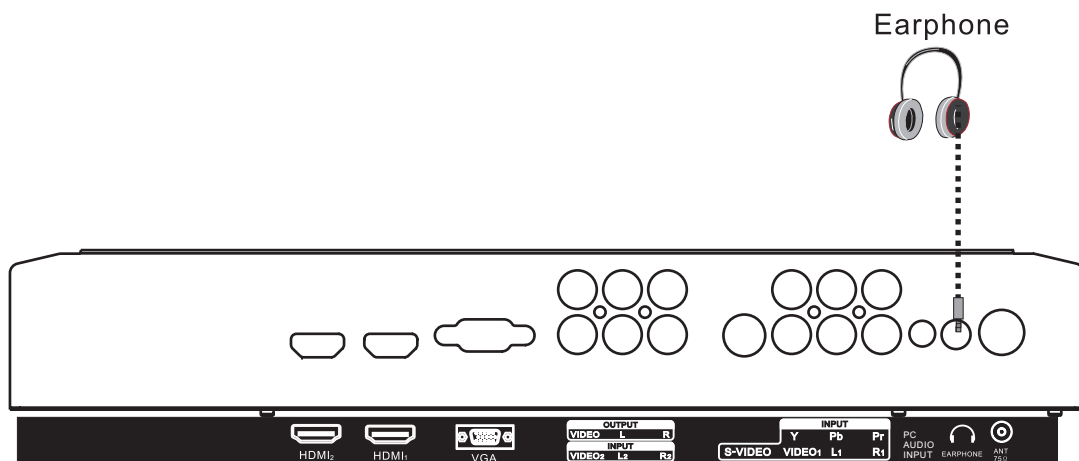

## PICTURE

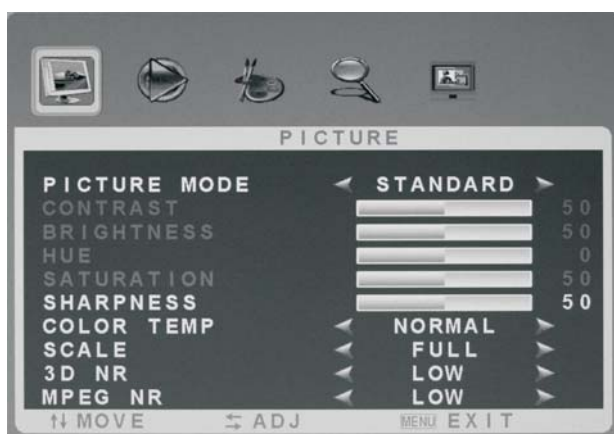

**Picture Mode:** Select the picture mode. you can choose "STANDARD,DYNAMIC, SOFT,USER"

**Contrast:** Adjust picture contrast.

**Brightness:** Adjust picture brightness.

**Tint:** Adjust NTSC colour signal.

**Saturation:** Adjust picture color.

**Sharpness:** Adjust picture sharpness.

**Colour Temp:** Adjust picture colour temp: cool, normal, warm mode.

**Scale Mode:** Select picture scale.

**3D NR:**3D noise reduce, you can choose "Off,Low,High"

**MPEG NR:**MPEG noise reduce, you can choose "Off,Low,High"

## SOUND



**Sound Mode:** Select the sound mode. you can choose "Standard,User,Music, Movie. "

**Bass:** Adjust bass volume.

**Treble:** Adjust treble volume.

**Balance:** Adjust the balance of sound between left and right speakers.

**AVC:** Auto Volume control function on or off.

## ADVANCE

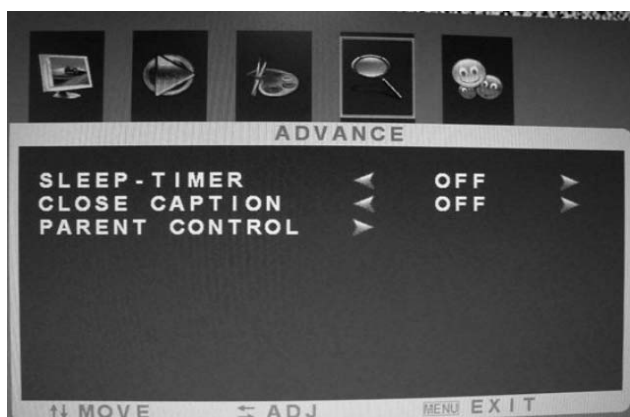

**Sleep Timer:**Select the sleep time to put automatically the TV in standby mode. Timer can be selected as 5min/10min/ 15min/30min/45min/60min/Off. Also you can select the sleep time by pressing SLEEP button repeatedly on the remote control

**CLOSE CAPTION:**Select the caption and TEXT modes(CC1,CC2,CC3,CC4,TT1,TT2,TT3, TT4,OFF).

# ADVANCE



**PASSWORD:** select this item to enter Change password menu.

The originality password is "0000".

**V-CHIP :**switch between On and Off.

**TV RATING:** To enter TV Rating setting menu, You will see as following:

Items	Hint
TV-Y	Young children
TV-Y7	Children 7 and over
TV-G	General audience
TV-PG	Parental guidance
TV-14	Viewers 14 and over

**.MOVIE RATING,** You will see as following:

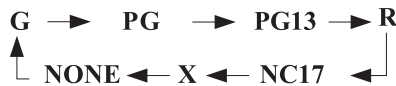

- G:** General audience (no restrictions).
- PG:** Parental guidance suggested.
- PG13:** Parents strongly cautioned.
- R:** Restricted. Children under 17 should be accompanied by an adult.
- NC17:** No children under age 17.
- X:** Adults only.
- NONE:** Not rated

**FRENCH ,** You will see as following:

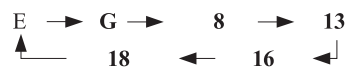

- E:** Exempt programming includes... news, programming, talk shows, music videos,
- G:** General programming.
- 8:** Not recommended for young children.
- 13:** Programming may not be suitable for.
- 16:** Programming is not suitable for children.
- 18:** Programming restricted to adults.

**ENGLISH ,** You will see as following:



- E:** Exempt programming includes... programming, talk shows,
- C:** Programming intended
- C8:** Programming generally on their own.
- G:** General programming,
- PG:** Parental Guidance.
- 14:** Programming contains the age of 14.
- 18:** Adult programming.

## OSD

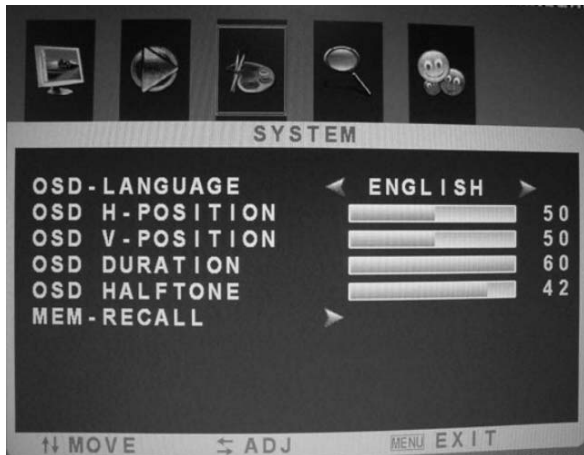

**language:** Into OSD menu select OSD Language.

**H-Position:** Adjust the H Position of the OSD menu.

**V- Position:** Adjust the V Position of the OSD menu.

**Duration:** Adjust the duration of OSD menu.

**Halftone:** Adjust the halftone of OSD menu.

**MEM-RECALL:** Restored to the factory default state .

## CHANNEL

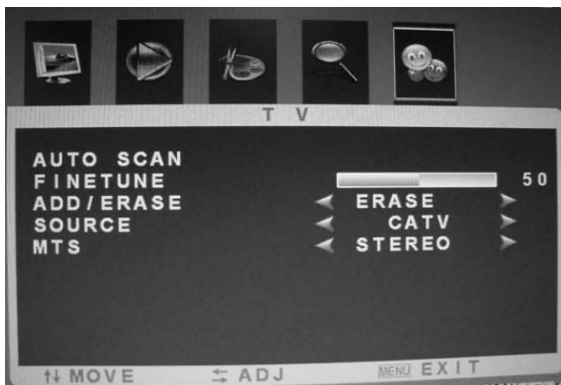

**Auto Scan:** press "▼ / ▲" button to select this item then press **Enter/▶** button to enter the Auto Channel Search Program.

**Fine Tuning:** if there are something wrong with the quality of picture and sound of TV, press "◀ ▶" to fine tune the tuner frequency, you can get the correct picture and sound.

**Add/Erase:** Add/Erase the Tv channel.

**Source:** select tuning band mode (Available tuning band mode: Air/Cable)

**MTS:** : Press to select the MTS mode. (for example, Nicam , BTSC, MONO, STEREO .eg )

## PIP(Optional)

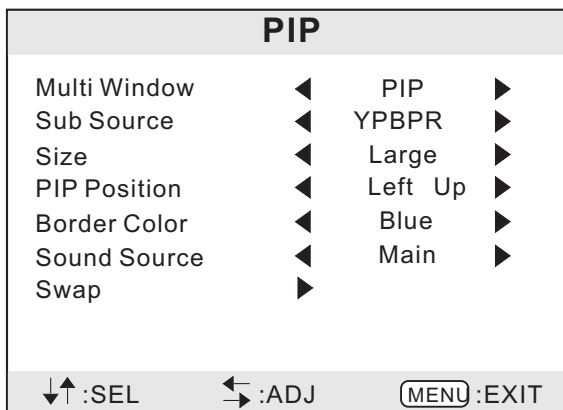

**Multi Window:** Adjust PIP ,POP Full and Off

**Sub Source:** PIP input mode select.

**Size:** Adjust PIP picture size.

**PIP Position:** Adjust PIP picture display position.

**Border Color:** Select PIP border color. (BLACK/BLUE)

**Sound Source:** Select main picture or other input audio.

**Swap:** PIP / Main picture position swap.

## PC

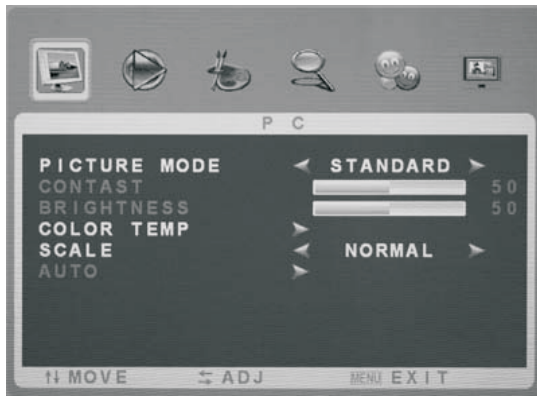

**Picture Mode:** Select the picture mode. you can choose "STANDARD,DYNAMIC, SOFT,USER"

**Contrast:** Adjust picture contrast.

**Brightness:** Adjust picture brightness.

**Colour Temp:** Adjust picture colour temp: cool, normal, warm mode.

**Scale Mode:** Select picture scale.

**Auto Adjust:** Auto adjust the H Position, V Position, Clock and Phase of the PC signal.

## GEOMETRY

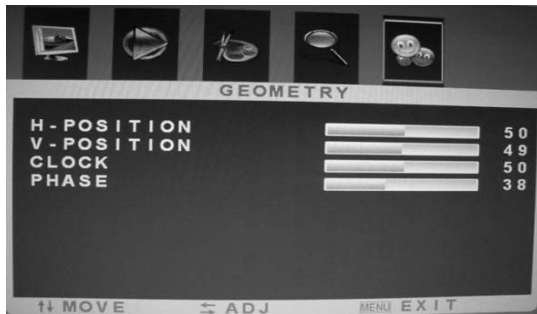

**H Position:** Adjust the H Position of the PC signal.

**V Position:** Adjust the V Position of the PC signal.

**Clock:** Adjust the clock of the PC signal.

**Phase:** Adjust the phase of the PC signal.

### NOTE:

- The TV also can be used as computer monitor. Electromagnetic interference in the environment May appear slight diagonal line interference. But this does not affect the quality of TV.
- In order to obtain better quality, with a recommendation of the use of high quality high noise isolation filter Quality HDMI / VGA cables.

## SOURCE

SOURCE
TV
AV
AV <sub>2</sub>
S-Video
Y Pb Pr
PC
HDMI
HDMI 2
↵:OK

- ① Press "SOURCE" button to display the source list;
- ② Press "▼ / ▲" button to select the "source" you want to watch;
- ③ Press "ENTER" button to enter the Input source ;

## RESOLUTION

### VGA

Resolution	<b>640x480</b>	<b>800x600</b>	<b>1024x768</b>	<b>1360x768</b>
Vertical frequency Hz	<b>60/75</b>	<b>60/75</b>	<b>60/75</b>	<b>60</b>

### HD(Y Pb Pr)

Resolution	<b>480i</b>	<b>480p</b>	<b>576i</b>	<b>576p</b>	<b>720p</b>	<b>1080i/p</b>
Vertical frequency Hz	<b>60</b>	<b>60</b>	<b>50</b>	<b>50</b>	<b>50/60</b>	<b>50/60</b>

### HDMI

Resolution	<b>480i</b>	<b>480p</b>	<b>576i</b>	<b>576p</b>	<b>720p</b>	<b>1080i/p</b>
Vertical frequency Hz	<b>60</b>	<b>60</b>	<b>50</b>	<b>50</b>	<b>50/60</b>	<b>50/60</b>

## MTS

Press the MTS button:

Usually set to **stereo** to provide the best reproduction, but if reception deteriorates or if the service is not Available then switch to Mono.

**Mono (M1) and (M2)** can also be selected if a mono signal is being transmitted.



# HELP

No Power	Check the AC cord of TV is plus in or not. If still no power, please Pull out the plug and replug in after 60 seconds. And open the TV again.
Signal receive not properly	To cause double image or phantom if there has high building or high mountain round -TV. You can adjust image effect by manually operation: consult instruction of vernier regulation or change the direction of external antenna. If you use the indoor antenna . under certain circumstance, receive will be more difficult .So you can change the direction of the antenna to adjust the image effect . If can't change image receiving effect either , you have to use external antenna.
No picture	Check the antenna at the back of TV is connected properly or not. Try to select other channels and check whether the TV problem itself or not.
Video is ok ,but without audio	Increase the volume. Check the TV is in mute mode or not , and please press the mute button to make sound resume.
Audio is ok, but color error or no picture.	Increase contrast and brightness.
snow statics picture and noise	Check the antenna at the back of TV is connected or not .
Level broken line	Maybe has electrical appliance interfere, such as hair drier, vacuum cleaner and so on, please turn off these kinds of electrical appliance.
Dual-Image or "simulacrum" The TV no response with the Remote.	Perhaps the location for the antenna is not good. Use the tall beamed antenna can be improved quality of the display image. Operate the remote direct to the remote sensor on the TV. If still no response for the TV, please check if the plastic bag on the remote take or not. And check if the location for the battery is correct. Change the new battery. The TV will shift to the STAND BY if no response from the remote in the few minutes.
NO Video In. (PC Mode)	Please check if the display cable connect to the VGA correcte . Please check if there has the bend on the display cable.
Vertical twinkling (PC Mode)	Enter the main menu, Use the clock regulator for the Video display noise to eliminate the vertical line.
horizontal ripping (PC Mode)	Adjust the Audio sound horizontal in the main menu to clear the horizontal ripping line.
The screen is too bright or too dark (PC Mode)	Adjust the contrast ratio or brightness in the main menu.
PC Function no response	Check the computer setting in the state of compatible display resolution
Ripping line in RCA connecting	Please use good quality connecting cable.
Problem still exist	Unplug the power cable and wait for 30 seconds, then connect. If there is some problem with our TV, do not repair it by yourself, please contact with the customer service center.

Note: There will be complete picture and the brightness will come down if the TV is in the static picture for too long time, So please do not keep the TV in a state of same Menu or same picture that has much difference in brightness and contrast ratio for too long time.

# SPECIFICATIONS

Screen Size	32"
Viewing angle	175° (Horizontal) / 175° (Vertical)
TV system	NTSC
Video system	PAL/NTSC
Preset Channels	1-200
Input/Output	TV, AV, S-Video, YPbPr, PC, HDMI
Speaker Output	8Ω 2X7W
Power requirement	AC 100--240V~, 50/60Hz
Power consumption	<135W
Accessories	User's manual    Remote controller 2 x AAA Batteries

**NOTE:**

This user manual is for reference only. Specifications are subject to change without notice.