

# user's guide

**RCA** | LCD FLAT PANEL HDTV





For use with models: L40FHD41/L42FHD37R  
/L46FHD37R

## contents

connections	6
remote	19
features	20
menus	25
FAQs	30
warranty	36

Need assistance?  
visit our website at [www.rca.com/tv](http://www.rca.com/tv)  
or call 1-877-794-7977

# Important Information

	<b>CAUTION</b> RISK OF ELECTRIC SHOCK. DO NOT OPEN			This symbol indicates that this product incorporates double insulation between hazardous main voltage and user accessible parts. When servicing, use only identical replacement parts.
<p>Caution: To reduce the risk of electric shock, do not remove cover (or back). No user serviceable parts inside. Refer servicing to qualified service personnel.</p>				
	This symbol indicates "dangerous voltage" inside the product that presents a risk of electric shock or personal injury.		This symbol indicates important instructions accompanying the product.	

**WARNING**  
To reduce the risk of fire or electric shock, do not expose this product to rain or moisture. This product should not be exposed to dripping or splashing. No objects filled with liquids, such as vases, should be placed on the component.

**WARNING**  
The TV is unstable if it is not properly attached to the base or mounted to the wall. Please follow the base or wall mounting instructions provided in the User's Guide to ensure your safety.

 This symbol indicates that this product contains mercury. Special disposal of this product for environmental reasons may be required under the laws applicable to your jurisdiction. For disposal or recycling information, please contact your local authorities or the Electronic Industries Alliance: [www.eiae.org](http://www.eiae.org).

Refer to the identification/rating label located on the back panel of your product for its proper operating voltage. FCC regulations state that changes or modifications to this unit not expressly approved by the party responsible for compliance could void the user's authority to operate the equipment.

Cable TV Installer: This reminder is provided to call your attention to Article 820-40 of the National Electrical Code (Section 54 of the Canadian Electrical Code, Part 1) which provides guidelines for proper grounding and, in particular, specifies that the cable ground should be connected to the grounding system of the building as close to the point of cable entry as practical.

Important: This television is a table model and is designed to sit on a firm, flat surface. Don't place the TV on soft carpeting or a similar surface, as the ventilation slots on the bottom of the unit may be blocked, resulting in reduced lifetime from overheating. To assure adequate ventilation for this product, maintain a spacing of 4 inches from the top and sides of the TV receiver and 2 inches from the rear of the TV receiver and other surfaces.

Also, make sure the surface or stand is of adequate size and strength to prevent the TV from being accidentally tipped over, pushed off, or pulled off. This could cause personal injury and/or damage to the TV. Refer to the Important Safety Instructions on the next page.

The power button (followed by the power symbol) on this TV and your remote control puts the TV into a very low-power standby mode but will not completely shut the power off. In order to shut the power off, you will need to disconnect the power cord from your outlet. Therefore, you should make sure the TV is installed in a way that allows you to disconnect the power cord when desired.

## Product Registration

Please fill out the product registration card (packed separately) and return it immediately. For US customers: Your RCA Consumer Electronics product may also be registered at [www.rca.com/television](http://www.rca.com/television). Registering this product allows us to contact you if needed.

## Product Information

Keep your sales receipt to obtain warranty parts and service and for proof of purchase. Attach it here and record the serial and model numbers in case you need them. These numbers are located on the product.

Model No. \_\_\_\_\_ Serial No. \_\_\_\_\_ Purchase Date \_\_\_\_\_  
Dealer/Address/Phone \_\_\_\_\_

# Important Safety Instructions

1. Read and follow all instructions.
2. Do not block any ventilation openings. Install in accordance with the manufacturer's instructions.
3. Do not install near any heat sources such as radiators, heat registers, stoves, or other apparatus (including amplifiers) that produce heat.
4. Do not negate the safety purpose of the polarized or grounding-type plug. A polarized plug has two blades with one wider than the other. A grounding type plug has two blades and a third grounding prong. The wide blade or the third prong is provided for your safety. If the provided plug does not fit your outlet, consult an electrician for replacement of the obsolete outlet.
5. Protect the power cord from being walked on or pinched particularly at plugs, receptacles, and the point where it exits from the component.
6. Do not use this component near water.
7. Only use the attachments/accessories specified by the manufacturer.
8. Clean only with dry cloth.
9. Use only with the cart, stand, tripod, bracket, or table specified by the manufacturer, or sold with the component. When the TV is placed on a cart, use caution when moving the cart to avoid injury from tip-over.
10. Unplug this component during lightning storms or when unused for long periods of time.
11. Refer all servicing to qualified service personnel. Service is required when the component is damaged in any way, such as power supply cord or plug damage, liquid spilled on or objects falling onto the component, rain or moisture exposure, abnormal operation, or if the component has been dropped.
12. If an outside antenna or cable system is connected to the product, be sure the antenna or cable system is grounded so as to provide some protection against voltage surges and built-up static charges. Section 810 of the National Electrical Code, ANSI/NFPA No. 70-1984 (Section 54 of Canadian Electrical Code, Part 1) provides information with respect to proper grounding of the mast and supporting structure, grounding of the lead-in wire to an antenna-discharge unit, size of grounding conductors, location of antenna-discharge unit, connection to grounding electrodes, and requirements for the grounding electrode. See following example:

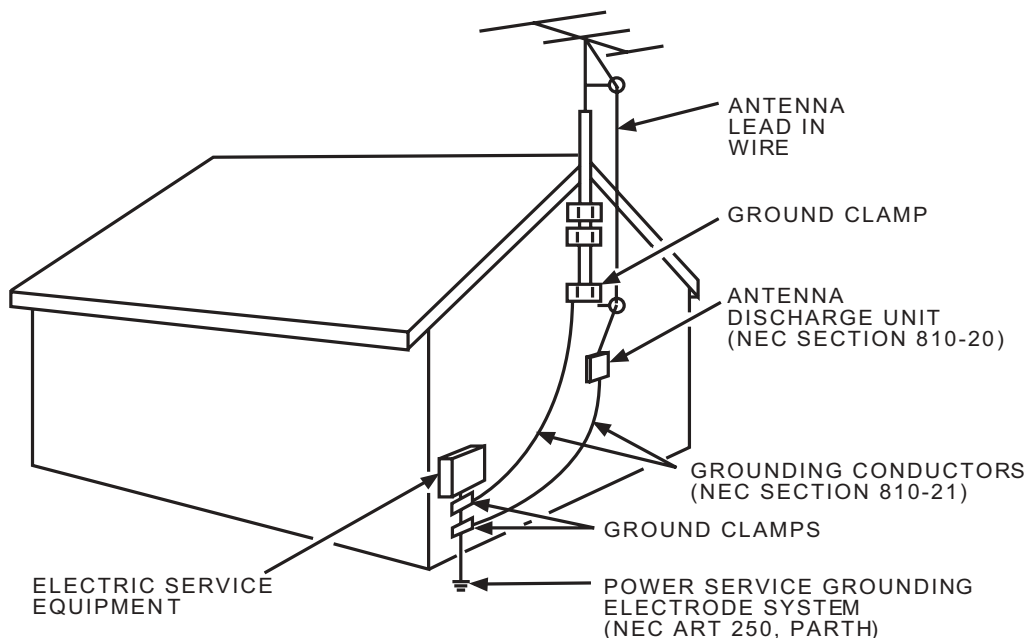

# Table of Contents

Important Information .....	i
Important Safety Instructions .....	i
<b>Chapter 1   Connections and Setup</b>	
<b>Before Initial Setup .....</b>	<b>6</b>
Protect Against Power Surges .....	6
Safety Information .....	6
Avoid Audio Interference .....	6
Avoid Direct Light .....	6
Check Supplied Parts .....	6
<b>Removing the Table Stand .....</b>	<b>7</b>
<b>Mounting Your TV to the Wall .....</b>	<b>7</b>
<b>Obtain the Signal .....</b>	<b>8</b>
What You Need .....	8
What You Need to Know .....	8
<b>Choose Your Connections .....</b>	<b>9</b>
Connecting a Component with Composite Video (Good) .....	10
Connecting a Component with Component Video (Better) .....	10
Connecting a Component with HDMI (Best) .....	11
Connecting a PC Component .....	12
Viewing the Picture from the Connected Component .....	13
Viewing a PC .....	13
<b>Plug in the TV .....</b>	<b>14</b>
<b>Put Batteries in the Remote .....</b>	<b>14</b>
<b>Turn on the TV .....</b>	<b>14</b>
<b>Using the Remote Control to Complete Initial Setup .....</b>	<b>14</b>
<b>Complete the Initial Setup .....</b>	<b>15</b>
Set the Menu Language .....	15
Set the TV Location Mode .....	15
Complete Channel Setup .....	15
<b>What To Expect .....</b>	<b>16</b>
Watching TV- Analog Channels .....	16
Watching TV – Digital Channels .....	16
Changing Channels .....	16
<b>Explanation of Jacks (in alphabetical order) .....</b>	<b>17</b>
<b>Buttons and Other Jacks on Your TV .....</b>	<b>18</b>
Side Input Jacks .....	18
Side Panel Buttons .....	18

## Chapter 2 | Using the Remote Control

<b>Remote Control Buttons</b> .....	<b>19</b>
-------------------------------------	-----------

## Chapter 3 | Using TV Features

<b>Channel Banner</b> .....	<b>20</b>
<b>Parental Controls and V-Chip</b> .....	<b>20</b>
V-Chip – US and Canada .....	20
Create Password .....	21
Lock/Unlock Parental Controls .....	21
V-Chip Rating Screen .....	21
US V-Chip TV Ratings .....	22
Blocking Specific Content Themes .....	22
US V-Chip Movie Rating Limit .....	23
Blocking Canada V-Chip Ratings .....	23
Reset Downloadable Data .....	23
Blocking Unrated/Exempt Programs .....	23
Block Channel .....	23
Block Buttons .....	24
Change Password .....	24
<b>Additional Features</b> .....	<b>24</b>
Screen Formats .....	24

## Chapter 4 | Using the TV Menu

<b>Using the Menu System</b> .....	<b>25</b>
<b>Picture Menu</b> .....	<b>25</b>
<b>Sound Menu</b> .....	<b>26</b>
<b>Setup Menu</b> .....	<b>27</b>
<b>List &amp; Labels Menu</b> .....	<b>29</b>
<b>Parental Control Menu</b> .....	<b>29</b>

## Chapter 5 | Other Information

<b>Frequently Asked Questions (FAQs)</b> .....	<b>30</b>
<b>Troubleshooting</b> .....	<b>31</b>
<b>V-Chip Rating Explanations</b> .....	<b>34</b>
US V-Chip Rating System .....	34
Canadian English V-Chip Rating System .....	34
Canadian French V-Chip Rating System .....	35
<b>Television Specification</b> .....	<b>35</b>
<b>Limited Warranty</b> .....	<b>36</b>
<b>Care and Cleaning</b> .....	<b>39</b>

# 1 Connections and Setup

## Before Initial Setup

### Protect Against Power Surges

- Connect all components before you plug any power cords into the wall outlet or power strip. NEVER plug your TV into an outlet that is controlled by a wall switch.
- Turn off the TV before you connect or disconnect any cables.
- Make sure all antennas and cables are properly grounded. Refer to the Important Safety Instructions.

### Safety Information

- Protect components from overheating.
- Don't block ventilation holes on any of the components. Arrange the components so that air can circulate freely.
- Don't stack components.
- If you place the component in a stand, make sure you allow adequate ventilation.
- If you connect an audio receiver or amplifier, place it on the top shelf so the heated air from it won't harm other components.

### Avoid Audio Interference

- Position cables properly; insert each cable firmly into the designated jack.
- If you place components above the TV, route all cables down one side of the back of the TV instead of straight down the middle.
- If your antenna uses 300-ohm twin lead cables, do not coil the cables.
- Keep twin lead cables away from audio/video cables.

### Avoid Direct Light

Don't place the TV where sunlight or room lighting is directed toward the screen. Use soft or indirect lighting.

### Check Supplied Parts

Check that the following parts were packed with your product.

#### Replacing your remote

If you need to replace your remote, call **1-800-257-7946**. A shipping and handling fee, and the appropriate sales tax, will be charged upon ordering. Please have your Visa or MasterCard ready.

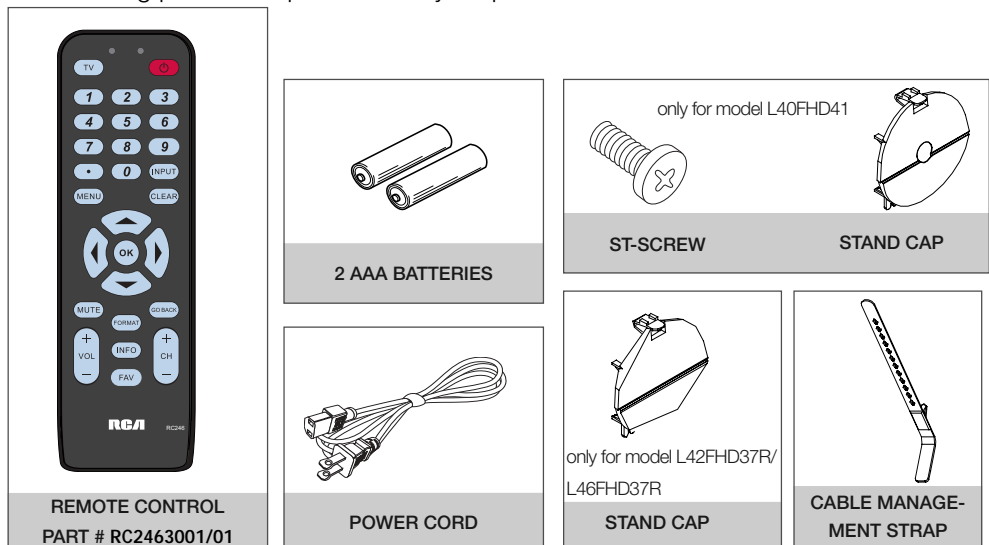

# Removing the Table Stand

Your TV comes with the table stand attached. If you want to mount your TV to the wall, remove the table stand by following the instructions below.

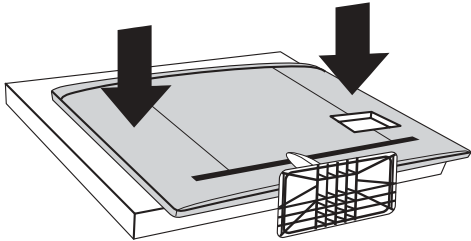

## Step 1

Place the plastic bag off the TV and place it on a table or other flat surface. Place the TV set face down on the TV bag.

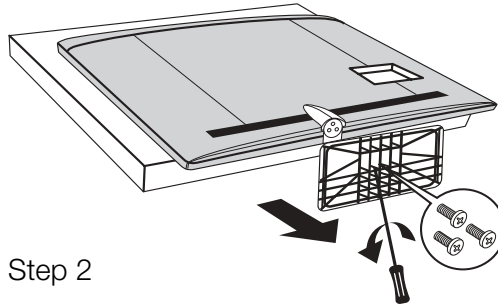

## Step 2

Remove the table stand from the TV cabinet. Use a screwdriver to remove the three M6 ST-screws. (Note: For model L46FHD37R, there are four M5 ST-screws.)

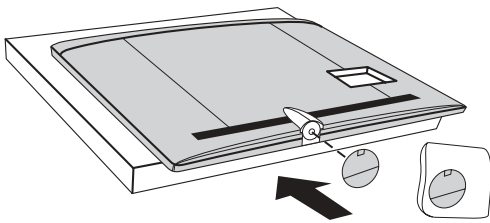

## Step 3 (Only for model L42FHD37R/L46FHD37R)

Attach the stand cap to the TV cabinet.

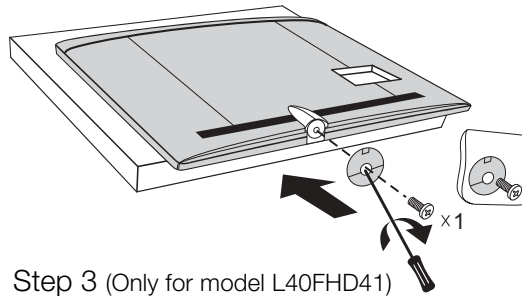

## Step 3 (Only for model L40FHD41)

Attach the stand cap to the TV cabinet using a M4 ST-screw and a screwdriver.

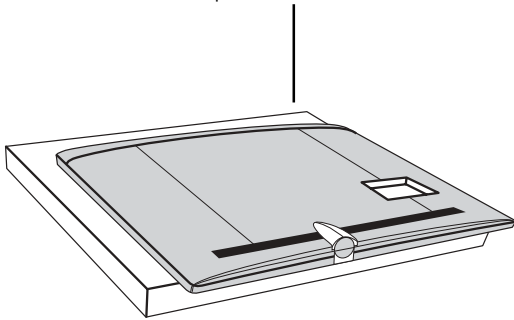

TV cabinet with stand cap attached.

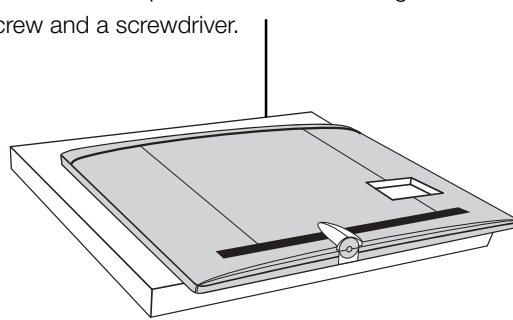

TV cabinet with stand cap attached.

# Mounting Your TV to the Wall

To mount your TV to the wall, purchase a VESA wall

Models L40FHD41/L42FHD37R/L46FHD37R

Purchase a VESA 600 x400, Size M6 screw

The VESA number is the horizontal and vertical measurement of the mounting holes. For example, 600x400 refers to fact that the mounting measurements are 600mm horizontally and 400mm vertically. Follow the directions included with the wall mount to mount the TV to the wall.

**Caution:** Your wall mount must be able to bear a minimum of five times the TV's net weight to avoid causing damage.

# Obtain the Signal

The first step in connecting your TV is obtaining the signal. The back panel of your TV allows you to receive analog and/or digital channels by using the ANTENNA/CABLE INPUT.

Before you connect your TV, you have to determine whether you will be using an antenna or a cable service to obtain the signal.

## What You Need

### Antenna (Rabbit Ears) or Outdoor Antenna with Coaxial Cable

Plug the antenna or coaxial cable from the wall outlet into the ANTENNA/CABLE INPUT on the back of the TV. You are ready to receive off-air local digital and analog channels.

### Cable Service

Plug the coaxial cable from the wall outlet into the ANTENNA/CABLE INPUT on the back of the TV. You are ready to receive your cable channels.

### Set-Top Box

If you have a set-top box, you may need to call your cable company or satellite service provider. They may recommend special cables to allow you to view digital channels.

## What You Need to Know



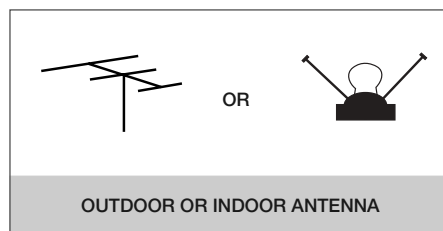
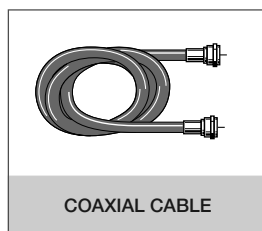





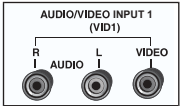

- Visit [www.antennaweb.org](http://www.antennaweb.org) for help in deciding what type of antenna to use in order to receive the local digital channels available to you. Enter your location, and the program will list local analog and digital stations available using your antenna.
- When you watch TV, the Channel Banner displays the type of channel currently viewed. A “D” at the bottom of the screen denotes digital channels and an “A” denotes analog channels. For more information on Channel Banners, see page 20.

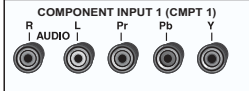

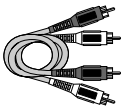

# Choose Your Connections

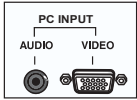
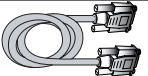
There are several ways to connect components, such as DVD players and setup boxes, to your TV. Please use the following chart to determine which connections are best for you. Proceed to the appropriate pages to connect your components.

Jacks Used	Cable Needed	Go to...
 <p>Audio R and L    Video</p>	 <p>Audio/Video</p>	page 10
 <p>Audio R and L    Y Pb Pr</p>	  <p>Component Video    Audio</p>	pages 10-11
 <p>Audio R and L    HDMI/DVI</p>	 <p>HDMI™</p> <p>OR</p>  <p>HDMI™ + HDMI/DVI Adapter + Audio</p>	pages 11-12
 <p>Audio    VGA</p>	 <p>VGA</p>  <p>Audio</p>	pages 12-13

**Customer Support**  
 For additional assistance in using your RCA product, please visit the support page at [www.rca.com/tv](http://www.rca.com/tv).

HDMI, the HDMI logo, and High-Definition Multimedia Interface are trademarks or registered trademarks of HDMI Licensing LLC.

Input	Signal Compatability
Ant/Cable	480i, 480p, 720p, 1080i (NTSC, ATSC, and QAM formats)
Composite Video	480i
S-Video	480i
Component Video	480i, 480p, 720p/60Hz, 1080i/60Hz, 1080p
PC	VGA, SVGA, XGA
HDMI	480i, 480p, 720p/60Hz, 1080i/60Hz, 1080p

## Connecting a Component with Composite Video (Good)

To connect a component with a video output jack, such as a DVD player, follow these steps:

Example: DVD Player

1. Connect the yellow video cable to the (VID 2) VIDEO jack on the side of the TV and to the video output jack on the DVD player.
2. Connect the red and white audio cables to the (VID 2) right and left audio jacks on the side of the TV and to the audio output jacks on the DVD player.

## Composite Video Connection

This is an example of a connection using the composite video jack.

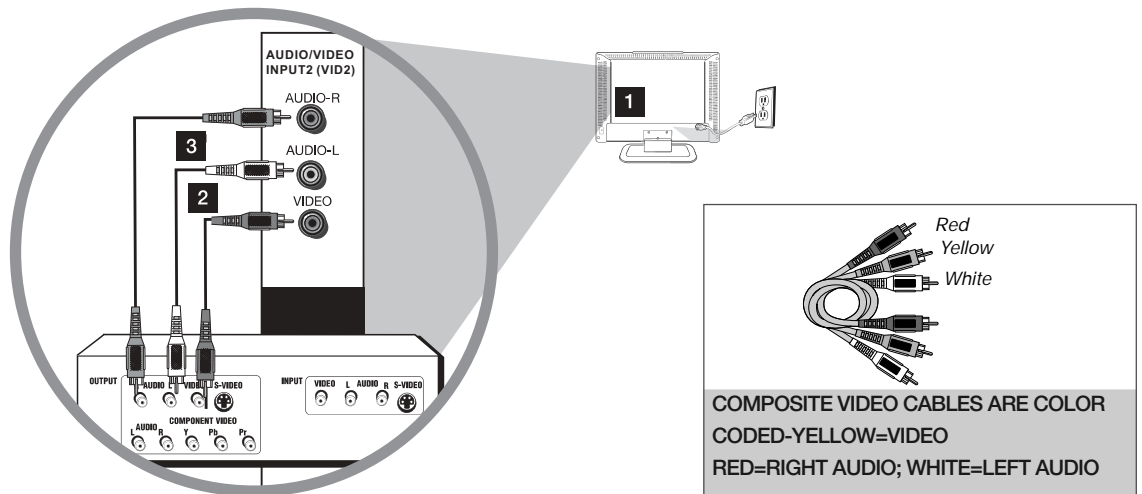

### Don't forget:

If necessary, connect antenna or cable to get a picture. Go to page 8 for instructions.

## Connecting a Component with Component Video (Better)

To connect a component that has Y Pb Pr jacks, such as a DVD player, follow these steps:

Example: DVD Player

1. Connect three video cables or special Y Pb Pr cables to the COMPONENT INPUT 2 (CMPT 2) Y Pb Pr jacks on the back of the TV and to the Y Pb Pr outputs on the DVD player.
2. Connect your red and white audio cables to the COMPONENT INPUT 2 (CMPT 2) right and left AUDIO jacks on the back of the TV and to the audio output jacks on the DVD player.

## Component Video Connection

This is an example of a connection using the component video jacks. Go to page 10 for specific instructions.

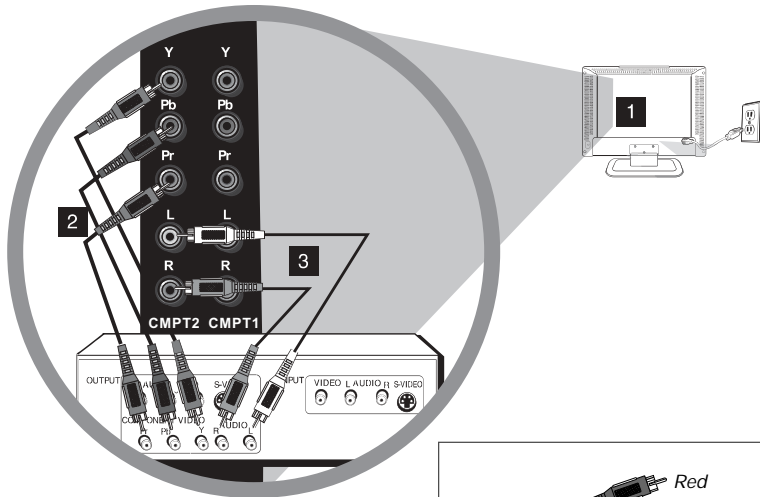

### **Don't forget:**

If necessary, connect antenna or cable to get a picture. Go to page 8 for instructions.

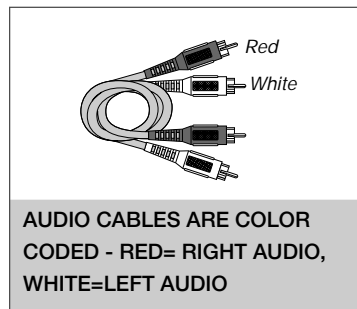

AUDIO CABLES ARE COLOR CODED - RED= RIGHT AUDIO, WHITE=LEFT AUDIO

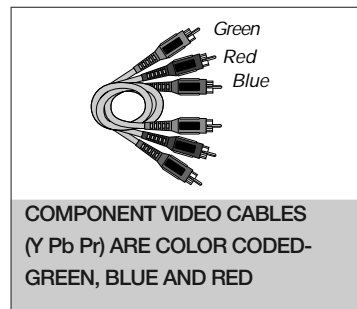

COMPONENT VIDEO CABLES (Y Pb Pr) ARE COLOR CODED- GREEN, BLUE AND RED

## Connecting a Component with HDMI (Best)

High-Definition Multimedia Interface (HDMI) technology is an uncompressed digital connection that carries both video and audio data by way of an integrated mini-plug cable. Since HDMI technology is based on Digital Visual Interface (DVI), the jack on the back of your TV is also compatible with components that have a DVI output jack.

### **Example: Set-top box with HDMI jack:**

1. Connect an HDMI cable to the HDMI INPUT 2 jack or the HDMI/DVI INPUT 1 jack on the back of the TV or the HDMI INPUT 3 jack on the side of the TV and to the HDMI output jack on the back of the set-top box.

### **Example: Set-top box with DVI jack:**

To connect an HDMI cable and an HDMI/DVI adapter:

1. Connect an HDMI cable to the HDMI/DVI INPUT 1 jack on the back of the TV.
2. Attach an HDMI/DVI adapter to the end of the HDMI cable; then connect the adapter to the DVI output jack on the set-top box.
3. Since you're using an HDMI/DVI adapter, you need to connect separate audio cables to the DVI AUDIO INPUT right and left DVI AUDIO jacks on the back of the TV and to the right and left audio jacks on the back of the set-top box.

## HDMI/DVI Connection (Best)

This is an example of a connection using the HDMI/DVI INPUT 1 jack. Go to page 11 for specific instructions.

### Don't forget:

If necessary, connect antenna or cable to get a picture. Go to page 8 for instructions.

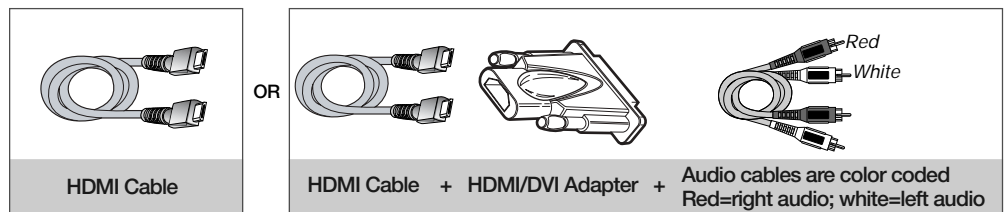
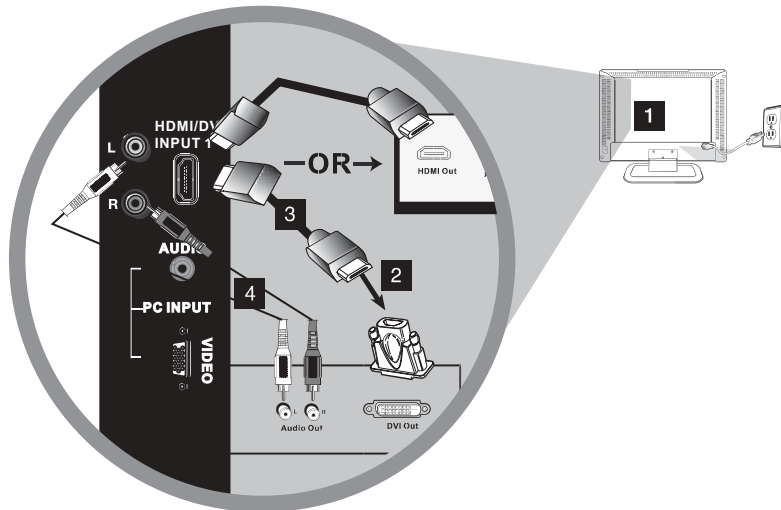

**Note:** The maximum resolution is 1920X1080. Be sure to set your PC monitor setting accordingly.

## Connecting a PC Component

To connect a personal computer and use your TV as a monitor, follow these steps:

1. Connect one end of a 15-pin monitor cable to the PC VIDEO jack on the TV and the other end to the PC's video output jack.

**Note:** If your PC's video output isn't 15-pin, you'll need an adapter that can connect to a 15-pin monitor cable.

2. Connect a 3.5mm stereo mini-pin audio cable (sometimes referred to as 1/8" stereo mini-pin) to the PC AUDIO jack on the back of the TV and the other end to the audio output jack on the PC.

## PC Connection

This is an example of a connection using the PC INPUT VIDEO jack. Go to page 12 for specific instructions.

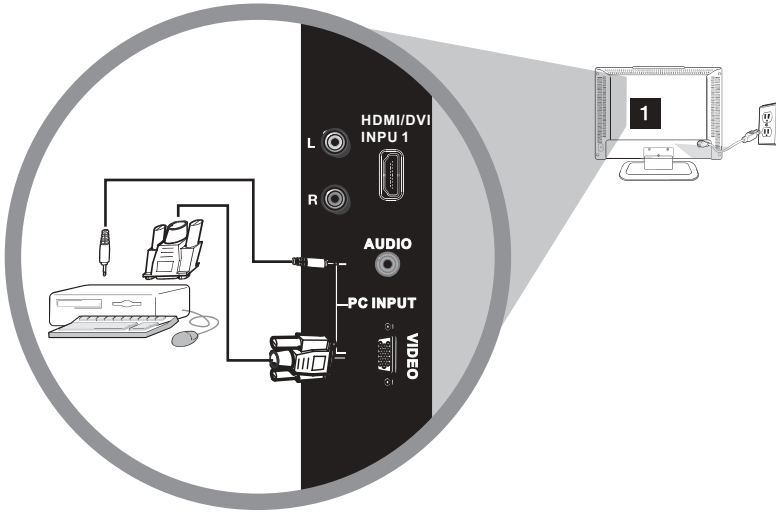

### **Don't forget:**

*If necessary, connect antenna or cable to get a picture. Go to page 8 for instructions.*

## Viewing the Picture from the Connected Component

1. Plug in the TV (see page 14 for details) and the component, such as a DVD player or a VCR.
2. Turn on the TV and the component you want to view.
3. Press the INPUT button on the remote control to display the signal source. Press the up or down arrow to select VID 2 (if connected to the VIDEO INPUT 2 jacks), CMPT 2 (if connected to the CMPT 2 jacks) or HDMI 1 (if connected to the HDMI/DVI INPUT 1 jack). Press OK to confirm your selection. To return to viewing TV channels, use the number buttons to enter the channel you wish to view.

**Note:** *If the picture from the DVD player appears black and white and your component is connected to the VIDEO INPUT, you may be tuned to the wrong input. Make sure you press INPUT and use the up or down arrow until you see VID 1, CMPT 2 or HDMI 1 displayed at the top left of the TV screen. Press OK to confirm.*

**Note:** *When you have connected all additional components to your TV, go to page 15 for initial setup instructions.*

## Viewing a PC

1. Plug in the TV and the computer.
2. Turn on the TV and the computer.
3. Press the INPUT button on the remote control to display the signal source. Press the up or down arrow to select PC. Press OK to confirm. To go back to viewing TV channels, use the number buttons to enter the channel you wish to view.

**Note:** *When you have connected all additional components to your TV, go to page 15 for initial Setup Instructions.*

## Plug in the TV

Plug the end of the power cord into the back of the TV. Plug the other end into an outlet, inserting the plug completely. Do not plug the TV into an outlet controlled by a light switch.

## Put Batteries in the Remote

- Remove the battery compartment cover from the back of the remote control by pushing the tab and lifting off the cover.
- Insert 2 AAA batteries, making sure the polarities (+ and -) are aligned correctly.
- Replace the cover.

## Turn on the TV

Turn on your TV by pressing the Power button (⏻) on the side of the TV or the ON•OFF or TV button on the remote control.

## Using the Remote Control to Complete Initial Setup

**Note:** Highlighted items stand out from other menu items on the list (appear darker, brighter, or a different color).

You will need to use the remote control to complete the setup of your TV. The remote control allows you to navigate through and select items that appear in the on-screen menus. The process works the same on all menu screens: highlight your choice and select it.

To select a menu item, press the arrows to highlight one of the items listed on the screen. Use the up or down arrow to move up or down. Use OK button or right arrow to view other selections for a menu choice or to display a sub-menu. To return to the previous menu, press the GO BACK key or left arrow.

# Complete the Initial Setup

The menu system in your TV allows all of the TV's features to work properly. The first time you turn on your TV, the language screen appears.

## Set the Menu Language

The first step of the setup requires you to select your preferred language for the menu system. If English is your preferred language, press OK and proceed to set the TV Location Mode. To choose another language, press the down arrow until that language is highlighted, and select it by pressing the OK button.

## Set the TV Location Mode

After choosing the language, a menu screen asks you to set the TV Location. Choosing "Home" for the TV Location assigns the optimal picture settings for most home environments. This is also the most energy-efficient setting. After Choosing "Home," press OK; the Picture Mode will automatically be set to "Natural" and the Setup Menu will display.

If choosing "Retail," which is not Energy Star compliant, press OK to display the options "Proceed" and "Go Back." Choose "Go Back," and press OK to return to the previous menu which allows the selection of Retail and Home Modes. Choose "Proceed" and press OK to confirm the selection of the Retail Mode. The Picture Mode will automatically be set to "Vibrant" and the Setup Menu will display.

## Complete Channel Setup

Make sure you've connected the TV to the cable or an off-air signal before you start the next part of the setup.

### Set the Signal Type

From the Setup menu, press the up or down arrow to highlight *Signal Type*. If you have connected the cable to your ANTENNA/CABLE INPUT jack, the option is chosen for you. Simply press the down arrow to continue. To choose ANTENNA, choose the OK button or right arrow and press the down arrow to continue.

### Complete the Channel Search

With *Channel Search* highlighted, press OK or the right arrow button to begin the channel search. If you chose *Cable* as your signal type, the search takes a while because the compiled list includes all available channels, (analog and digital) and initially includes scrambled channels. Scrambled channels are removed from the list after all channels are identified.

The Channel Search process includes the following steps:

1. The search first seeks analog channels and places the number of channels found next to *Analog Channels Found*.
2. The search then looks for digital channels and places the number of channels found next to *Digital Channels Found*. This number may seem high. This is because the number includes both scrambled (for example, Pay Per View) and non-scrambled channels, depending on what your cable company is sending. You may not be able to view all of the detected channels; some of the digital cable channels may be scrambled.
3. When *Channel Search* is in progress, you can press the CLEAR button to cancel the search. Any channels already found will be stored.
4. When Channel Search is complete, the menu will clear automatically after a few seconds.

You may find there are still some channels in your list that are unavailable to view. To delete these channels, press MENU and choose *List and Labels*. Removing channels from your channel list may be time-consuming, so you may want to do it later. Go to page 29 for details on editing your channel list.

**Note:** If you are using a satellite or cable set-top box, you do not need to complete Channel Search.

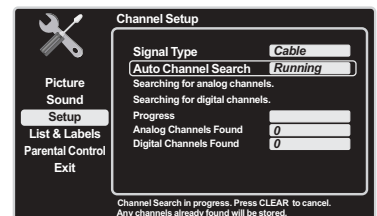
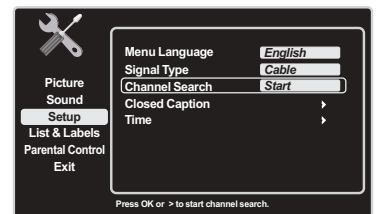
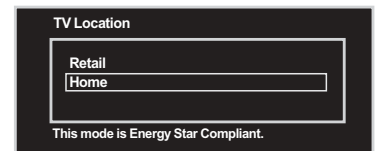
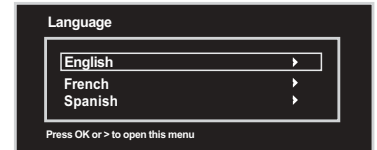

# What To Expect

## Watching TV

### Analog Channels

An “A” next to the channel number denotes that you are watching an analog channel. Analog video is sent in a 4/3 format. Your TV can display these channels in a 16/9 format by pressing the FORMAT button to view the different formats available. Go to page 24 for more explanation of screen formats.

## Watching TV

### Digital Channels

A “D” next to the channel number denotes that you are watching a digital channel. Most digital video is sent in a 16/9 format, which fills the screen. However, it is sometimes sent in 4/3 format, which does not fill your screen. The format is dependent on how the station or source component is configuring the video.

*Note: If there are bars on-screen, press the FORMAT button to try a different format. This may eliminate the bars. Some bars can't be removed because of the way the signal is sent by the broadcaster. Go to page 24 for more explanation of screen formats.*

## Changing Channels

- Digital channels can have both primary channels (like the analog channel number) and sub-channels. To tune to a digital channel with a sub-channel, such as 10.1, enter the primary channel number (10), then press the “.” button. Enter the sub-channel number (1) and press OK.
- Depending upon the type of signals you have connected to your HDTV, you may notice that the channels change more slowly than usual. This is perfectly normal. Digital channels sometimes take longer to tune.



# Explanation of Jacks (in alphabetical order)

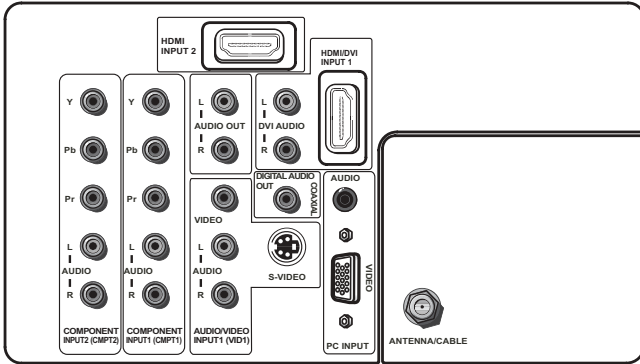

This section describes the jacks on the back panel of your TV. There are several ways to connect components.

**ANTENNA/CABLE INPUT** Lets you connect a coaxial cable to receive the signal from your antenna, cable, or cable box.

**AUDIO/VIDEO INPUT 1 (VID 1)** Lets you connect a component that has composite video jacks, such as a VCR or DVD player.

- **L AUDIO** Provides left audio connection when using the VIDEO INPUT 1 jack or the S-VIDEO INPUT jack. The left audio connectors are usually white. For mono audio sources, be sure to use the left AUDIO INPUT.
- **R AUDIO** Provides right audio connection when using the VIDEO INPUT 1 or the S-VIDEO INPUT jack. The right audio connector is usually red.

**COMPONENT INPUTS** Let you connect a component that has component video jacks, such as a DVD player.

- **CMPT 1/CMPT 2 Y Pb Pr (Component Video)** Provides good picture quality because the video is separated into three signals. Use three video-grade or component video cables for the connection. When using CMPT 1/CMPT 2 Y Pb Pr, make sure you connect left and right audio cables to the CMPT 1/CMPT 2 L and R AUDIO jacks.
- **CMPT 1/CMPT 2 L AUDIO** Provides left audio connection when using the CMPT 1/CMPT 2 VIDEO inputs. The left audio connector is usually white. For mono audio sources, be sure to use the left AUDIO input.
- **CMPT 1/CMPT 2 R AUDIO** Provides right audio connection when using the CMPT 1/CMPT 2 VIDEO inputs. The right audio connector is usually red.

**DIGITAL AUDIO OUTPUT (coaxial)** Use a digital coaxial cable to connect your TV to a compatible audio receiver.

**VARIABLE AUDIO OUTPUT** Use left and right audio cables to connect your TV to a compatible audio receiver.

**HDMI INPUT 2** Lets you connect a component, such as a digital cable box, with an HDMI output for the best picture quality.

**HDMI/DVI INPUT 1 (High-Definition Multimedia Interface/Digital Visual Interface)** Provides an uncompressed digital connection that carries both video and audio data by way of an integrated mini-plug cable. Since HDMI technology is based on Digital Visual Interface (DVI), the jack on the back of your TV is also compatible with DVI components.

- **DVI AUDIO L (used for DVI only)** Provides left audio connection when using the HDMI 1 jack for DVI. The left audio connector is usually white. For mono audio sources, be sure to use the left AUDIO input.
- **DVI AUDIO R (used for DVI only)** Provides right audio connection when using the HDMI 1 jack for DVI. The right audio connector is usually red.

*Note: If using a DVI component, remember to connect the left and right audio cables because the DVI cable carries only the picture signal, not the sound.*

**PC VIDEO INPUT** Connect your computer or other component with a VGA output to this jack using a 15-pin, D-sub cable.

**PC AUDIO (Stereo mini jack)** Use to obtain sound when a PC is connected to the PC input. Use a 3.5mm stereo mini-pin cable (sometimes referred to as 1/8" stereo mini-pin) to connect a PC to your TV.

**S-VIDEO INPUT** Allows you to connect an S-Video cable from another component. Make sure you also connect audio cables from the component to the TV. To access a component connected to the S-Video jack, press the INPUT button on your remote; then press the up or down arrow to select S-VID. Press the OK button to confirm.

*Note: Do not connect to both the S-VIDEO and VIDEO jacks on VID1 at the same time.*

# Buttons and Other Jacks on Your TV

## Side Input Jacks

**SERVICE** For service use only.

**HDMI INPUT 3** Lets you connect a component with an HDMI output.

**AUDIO/VIDEO INPUT 2 (VID 2)** Lets you connect a component that has composite video jacks, such as a VCR or DVD player.

- **L AUDIO** Provides left audio connection when using the VIDEO INPUT 2 jack. The left audio connectors are usually white. For mono audio sources, be sure to use the left AUDIO INPUT.
- **R AUDIO** Provides right audio connection when using the VIDEO INPUT 2 jack. The right audio connector is usually red.

**HEADPHONES** Allow you to connect headphones to listen to the sound coming from the TV.

## Side Panel Buttons

If you cannot locate your remote, you can use the side panel buttons on your TV to operate many TV features.

**(⏻) POWER** Turns the TV on and off.

**MENU** Brings up the TV Main Menu.

**VOL (▶)** Increases the volume. In the TV menu system, it acts like the right arrow on the remote control and can be used to select menu options.

**VOL (◀)** Decreases the volume. In the TV menu system, it acts like the left arrow on the remote control and can be used to select menu options.

**CH (▲)** Scans up through the channel list. In the TV menu system, it acts like the up arrow on the remote control and can be used to select menu options.

**CH (▼)** Scans down through the channel list. In the TV menu system, it acts like the down arrow on the remote control and can be used to select menu options.

## 2 Using the Remote Control

### Remote Control Buttons

**Number Buttons** Using these buttons, enter channel numbers.

To enter a channel, press the number buttons and press OK (or let the entry timeout).

To enter a digital channel with a sub-channel, enter the main channel; then, press the "." button to enter the sub-channel and press OK.

**Arrows** (◀/▶/▲/▼) Use the four arrows to highlight different items in the TV menu and to adjust the menu controls.

**CH + or CH -** Scans up or down through the current channel list. Press once to change the channel up or down; press and hold to continue changing channels.

**CLEAR** Removes any menu or display from the screen and returns you to normal viewing.

**FAV** Press to browse the channels in your favorite list. Use the arrows to highlight options, and press OK to select. Or press the FAV button repeatedly to cycle through your favorite channels.

**FORMAT** Press to change the screen formats. Press the up or down arrow to choose the available options or press the FORMAT button repeatedly to cycle through the options. Go to page 24 for more information on screen formats.

**GO BACK** Returns to the previous channel.

**INPUT** Accesses the available video input channels (Watch TV, VID 1, VID 2, S-VID, CMPT 1, CMPT 2, PC, HDMI 1, HDMI 2 and HDMI 3). Use the arrows to highlight options, and press OK to select. Or press the INPUT button repeatedly to cycle through options. To resume TV viewing, press the number buttons to enter the channel.

**INFO** If no menus are on-screen, displays the Channel Banner; press again to show upcoming program information, if available. Pressing three times clears the screen.

**MENU** Accesses the Main Menu.

**MUTE** Reduces the TV volume to its minimum level. Press again to restore the volume.

**OK** When in the menu system, pressing the OK button selects the highlighted item.

**(⏻) (ON•OFF)** When in TV Mode, pressing this button turns the TV on or off.

**TV** Press to display the Channel Banner.

**VOL - or VOL +** Decreases or increases the TV volume.

#### Using the INPUT Button

Use the INPUT button to scroll through the available video input channels and view components you have connected to the TV.

1. Make sure the component you wish to view is turned on.
2. Press INPUT to display the input choices. Press the up or down arrow to choose the available video input source or press the INPUT button repeatedly to cycle through the options.
3. Press OK to tune to it and view the component.



Remote control part number RC2463001/01

**Note:** This TV utilizes new remote control signal codes and may not be compatible with your existing universal remote (e.g. satellite box remotes, cable box remotes, generic universal remotes, etc.). Over time, newer universal remote controls that become available should pick up the new TV codes.

## 3 Using TV Features

### Channel Banner

There are several indicators that may appear when you press the INFO button on the remote control. This display is called the Channel Banner. The following list describes the items on the Channel Banner screen (left to right and top to bottom).



- |                       |   |
|-----------------------|---|
| <b>A 135</b>          | If the channel is analog, <i>A</i> is displayed. If it's a digital channel, <i>D</i> is displayed. The channel, sub-channel (if available for digital channels) and channel name or label you're currently viewing are displayed. |
| <b>Mono</b>           | Displays whether the current channel is being broadcast in stereo or mono. If the current channel is digital, this space will be blank.   |
| <b>SAP</b>            | If the current channel is analog, this shows if it is broadcasting SAP (Second Audio Program) information. If the current channel is digital, this area shows the language, if provided by the broadcaster.                       |
| <b>Parent Control</b> | The Parent Control state (locked or unlocked) of the current program or channel.  |
| <b>1:14 PM</b>        | Current time.   |

### Parental Controls and V-Chip

The choices in the US V-Chip and Canada V-Chip menus involve software inside your TV, referred to as V-Chip, which allows you to block TV programs and movies. TV programs can be blocked by age-based ratings, such as TV-MA (See page 22). If available, TV programs can also be blocked by content, such as adult language (L) (See page 22). Movies can only be blocked by age-based ratings (See page 23). Once you block programs, you can unblock them by entering a password. By default, the software inside your TV is turned off or unlocked. For instructions to lock V-Chip, see page 21.

#### V-Chip - US and Canada

V-Chip reads the program's age-based rating (*TV-MA*, *TV-14*, etc.) and content themes (Violence (*V*), Adult Language (*L*), etc.). If you have blocked the rating and/or content themes that the program contains, you receive a message that the channel is currently blocked. Change the channel or press OK to enter your password and temporarily deactivate the parental controls.

Broadcasters are not required to provide content themes, so programs received with no content themes are blocked only if you block their age-based rating. You can also block programs that have been given an Exempt rating, and programs that are considered unrated. See page 34 for the US and Canada ratings explanations.

**Note:** Parental control settings are not available for HDMI 1, HDMI 2, HDMI 3, CMPT 1, CMPT 2, or PC INPUTS. These settings must be set in the connected component's parental controls.

## Create Password

This option enables you to set your own password for parental controls.

1. Press MENU on the remote control. The Main Menu appears.
2. Press the up or down arrow to select Parental Control.
3. Press OK or the right arrow button to display options.
4. Select Create Password; then press OK or the right arrow button to open this menu.
5. Select *New Password*, then enter your own password using the digit keys.
6. Select *Confirm*, then re-enter your own password using the digit keys.
7. Press Go Back or the left arrow to go back to the previous menu.

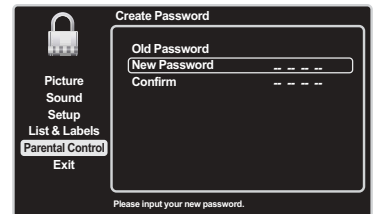
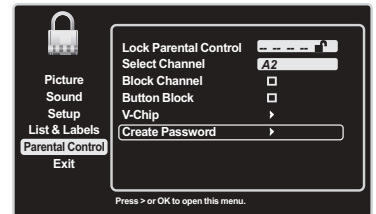

**Note:** If you do not lock parental controls, none of the settings for V-Chip, Button Block or Block Channel will take effect.

## Lock/Unlock Parental Controls

- When the Parental Control Menu is accessed from the Main Menu and the parental controls are permanently unlocked, the following message is displayed:  
*“Parental Controls are UNLOCKED. Rating limits and Channel Block will NOT require a password to view the picture. To lock, use ‘Lock parental controls’ function. Press OK key to continue.”*
- Press OK or the right arrow button to display the Parental Control Menu and highlight *Lock Parental Control*. Enter your four-digit password using the digit keys.

**Note:** When you enter the correct password, the Parental Control menu is displayed. For information on changing a password, see page 24. If you forget your password, turn off the TV. Simultaneously press and hold VOL down button on the side panel and CLEAR button on the remote for 5 seconds. The next time you enter the Parental Control menu, you will be able to enter a new password.

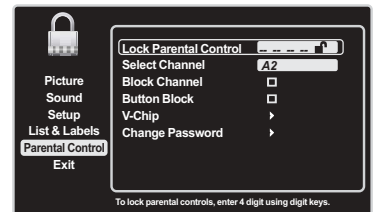

## V-Chip Rating Screen

The following graphic details where items are located within the TV Ratings option with the US V-Chip menu.

### Rating Status Field

Lets you select whether the status of the age-based rating to the left limit is view or block.

### Rating Field

Lets you select from a list of age-based ratings you can block or view.

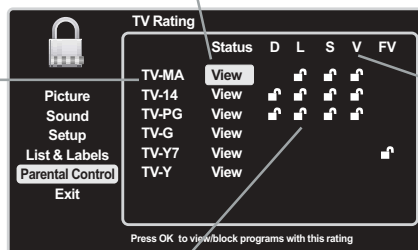

### Content Themes

Lets the content themes you can block or view.

### Content Status Fields

Lets you select which content themes to view for the selected rating, and whether the status of the content theme is currently unlocked (🔓) or locked (🔒).

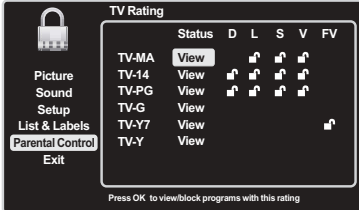

**Note:** Broadcasters are not required to provide content themes or age-based ratings. You must remember to lock Parental Controls for rating limits to take effect.

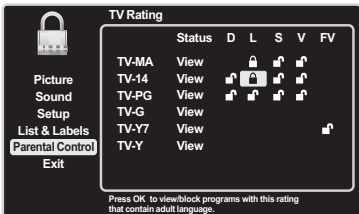

## US V-Chip TV Ratings

### Blocking Age-Based Ratings

You can automatically block all program ratings above a specified age-based rating level.

1. Choose *Parental Control* from the Main Menu. If parental controls have previously been locked, you must enter your password.
2. Highlight and select V-Chip.
3. Highlight and select *US V-Chip*.
4. Highlight and select *TV Rating*.
5. Press the up or down arrow to scroll to the rating corresponding with the lowest rating you wish to block.
6. Press the OK button to toggle between *View* and *Block*. The status for the rating and all higher ratings automatically changes to *Block*.
7. Use the GO BACK button or left arrow repeatedly to return to the Parental Control Menu.
8. Select *Lock Parental Control* from the Parental Control Menu. For rating limits to take effect, enter the correct password.

To view age-based ratings after you've locked them, follow the same steps as above to unlock.

### Blocking Specific Content Themes

You can block programs based on their content. (Content is represented by the *D*, *L*, *S*, *V* and *FV* on your screen.) When you block a content theme for a particular rating, you automatically block that content theme for higher-rated programs as well. To block program content:

1. Choose *Parental Control* from the Main Menu. If parental controls have previously been locked, you must enter your password.
2. Highlight and select V-Chip.
3. Highlight and select *US V-Chip*.
4. Highlight and select *TV Ratings*.
5. Determine the content themes you want to block.
6. Press the down arrow to scroll to the rating whose content theme you want to change.
7. Press the right arrow to highlight a particular content theme.
8. Press the OK button to change its status to block. (For example, if you block the language (*L*) corresponding with *TV-14*. The language for *TV-MA* is blocked as well.)

To view content themes after you've locked them, follow the same steps as above to unlock.

**Note:** If you unlock the language corresponding with *TV-14*, the language for *TV-MA* doesn't unlock. You have to unlock the content theme status for each rating separately.

Hierarchy of Age-Based Ratings	
TV-MA	Mature Audience Only
TV-14	Parents Strongly Cautioned
TV-PG	Parents Guidance Suggested
TV-G	General Audience
TV-Y7	Directed to Children 7 Years and Older
TV-Y	All Children

Content Themes	
D	Sexually Explicit Dialogue
L	Adult Language
S	Sexual Situations
V	Violence
FV	Fantasy Violence

## US V-Chip Movie Rating Limit

Set movie rating limits by blocking movies rated above a specified level. To access the Movie Rating Limit Menu, follow these steps:

1. Press MENU on the remote control (the Main Menu appears).
2. Select *Parental Control*.
3. Highlight and select *V-Chip*. Then highlight and select US V-Chip.
5. Highlight and select *Movie Ratings*.
6. Press the down arrow to scroll to the rating you want to change.
7. Press the OK button to change its status to block (all ratings above the one you selected change to block).
8. Press the GO BACK button or the left arrow repeatedly to exit the Parental Control Menu.

## Blocking Canada V-Chip Ratings

If you receive Canadian programs, you can block Canadian English and French V-Chip by ratings only. When you block a particular rating, you automatically block the higher-rated programs as well. To block Canadian English and French program ratings, follow these steps:

1. Press MENU on the remote control (the Main Menu appears).
2. Select *Parental Control*.
3. Highlight and select *V-Chip*.
4. Select *Canada V-Chip*.
5. Highlight *English Ratings* or *French Ratings* and press OK.
6. Press the down arrow to scroll to the rating you want to change.
7. Press the OK button to change its status to block (all ratings above the one you selected change to block).
8. Press the GO BACK button or left arrow repeatedly to exit the Parental Control Menu.

## Reset Downloadable Data

Select this option and press OK to reset downloadable rating data, if present.

## Blocking Unrated/Exempt Programs

The *Unrated/Exempt Ratings* option lets you decide if programs that the V-Chip recognizes as unrated or exempt can be viewed. Unrated TV programs may include news, sports, political, religious, local and weather programs, emergency bulletins, public announcements, and programs without ratings. The Exempt option applies to both US and Canadian unrated programs and Canadian programs rated E. Press the down arrow to highlight *Unrated/Exempt Ratings*. Then press the OK button or the right arrow to toggle between *View* and *Block*.

**View** All unrated programs are available.

**Block** All unrated programs are not available.

## Block Channel

Turn this option on to block the channel you choose in the *Select Channel* option. Use the CH+ or CH- to find the channel you want to block. Then press the down arrow to select *Block Channel*. Press the OK button to place a checkmark in the *Block Channel* box to block the channel. When you tune to that channel, you'll need to enter a password to view the channel if parental control is locked. Press the GO BACK button or left arrow repeatedly to exit the Parental Control Menu.

**Note:** These ratings are available only if the broadcaster is sending them.

**Note:** You must remember to lock parental controls for rating limits to take effect.

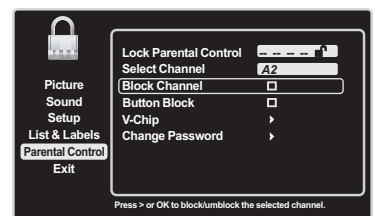
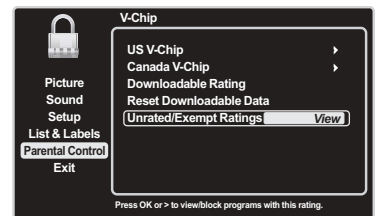
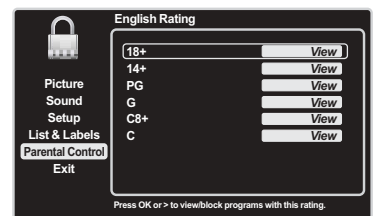



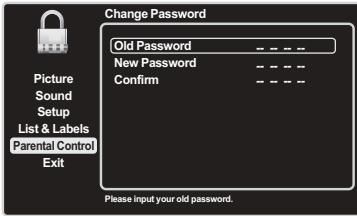
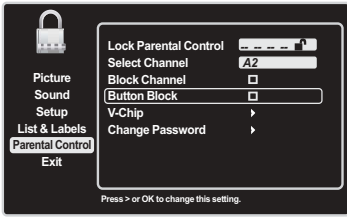

**Note:** For HD Video, press **FORMAT** to choose from *Full*, *Expand*, *Cinerama* and *Zoom*. For VGA signal, choose from *Normal*, *Full*, and *Dot By Dot*. For HDMI and CMPT inputs, there is also a *No Overscan* format.

## Block Buttons

Select this option to block (disable) or unblock (enable) the TV's side panel buttons so that they can't be used. The remote still tunes to any channel. If you're using this to keep children from changing channels, remove access to any remote that is capable of operating the television while you have the side panel blocked. Don't forget to lock parental controls after you change the status. If you don't, the *Button Block* action will not take effect.

## Change Password

This option allows you to set a new V-Chip password. From the Parental Control Menu, highlight and select **Change Password**. Using the digit keys, enter a new password and press **OK**. Re-enter the new password again for verification and press **OK** to confirm.

## Additional Features

There are additional features available unrelated to parental controls.

### Screen Formats

Screen format refers to the way the picture is displayed on your TV. Press the **FORMAT** button on your remote to see if a different format is available for the video you are viewing. The format changes as you press the **FORMAT** button, and the format type is displayed at the top left of the screen.

Analog video is sent in a 4/3 format, which your TV displays in a 16/9 format. Most digital video is sent in a 16/9 format which fills your screen, but it sometimes is sent in 4/3, which does not fill your screen. It depends on how the station or component connected to your TV is formatting the video. If there are bars on the screen, press the **FORMAT** button to try a different format that may eliminate the bars. Some bars can't be removed because of the way the format is sent by the broadcaster.

Examples of the different formats for SD Video appear below.

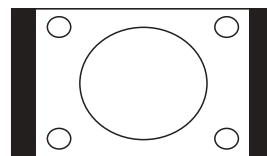

Normal

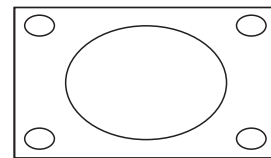

Full

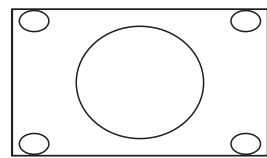

Cinerama

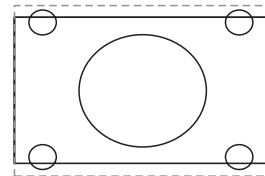

Zoom



# 4 Using the TV Menu

## Using the Menu System

This section explores the menus of your TV. Each menu is outlined and detailed to help you get the most from your TV. The Parental Control Menu is discussed in Chapter 3. To access the menu system, follow these steps:

1. Press the MENU button.
2. Use the up or down arrow to highlight an option and press OK or the right arrow to display it.
3. Press the up and down arrow to move to a different option within the menu. If necessary, press OK or right arrow to display the choices of the option you've highlighted. If available, use the text at the bottom of each screen for help.
4. To return to the previous menu, press the GO BACK or left arrow.

Descriptions of each menu are discussed in the order they appear.

There are two ways to exit a menu:

- Press the CLEAR or Menu button. The menus are cleared from the screen and you return to TV viewing.
- Press the GO BACK or left arrow repeatedly until the menus disappear.

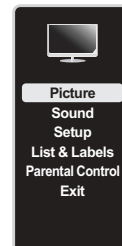

## Picture Menu

The Picture Menu contains menus and controls to configure the way the picture appears. The Picture Menu options apply to the video for the main TV and VIDEO INPUT selections. All picture options can be applied to each input - VID 1, VID 2, CMPT 1, CMPT 2, HDMI 1, HDMI 2, HDMI 3, and PC.

Press MENU on the remote. Select *Picture* from the Main menu. Press the OK button or right arrow to display options.

### Picture Settings:

**Preset - (not available on PC)** Allows you to select one of the preset picture settings: *Vibrant, Sports, Personal, Natural, or Cinematic*. Choose the setting that is best for your viewing environment.

**Brightness** - Use the left or right arrow to adjust the brightness of the picture.

**Color (not available on PC)** - Use the right or left arrow to adjust the richness of the color.

**Sharpness (not available on PC)** - Use the right or left arrow to adjust the crispness of the edges in the picture.

**Tint (not available on PC)** - This option adjusts the balance between the red and green levels.

**Contrast** - Use the left or right arrow to adjust the difference between the light and dark areas of the picture.

**Horizontal (only available on PC)** - Adjust the picture's position leftward or rightward.

**Vertical (only available on PC)** - Adjust the picture's position to downward or upward.

**Phase (only available on PC)** - Adjust the picture if there is flicker of screen letters, color misalignment or blurring.

**Auto Adjustment (only available on PC)** - Adjust the picture's position, phase automatically.

### Advanced Picture Settings (not available on PC) :

#### Light Sensor

When activated, this feature monitors the ambient light conditions in the room and adjusts the TV's backlight for optimum viewing. It also serves as an energy-saving feature by lowering the backlight power level when appropriate (typically in darker room conditions).

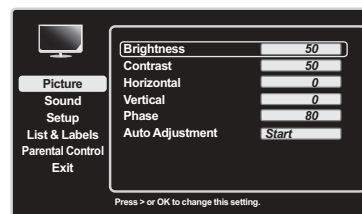
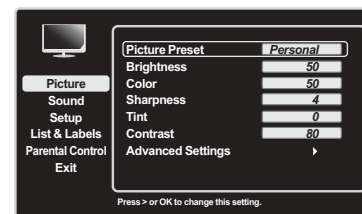

Picture menu in PC mode

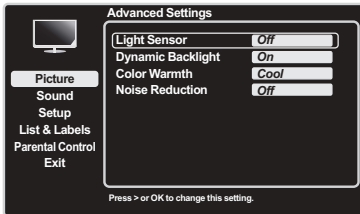

**Dynamic Backlight** Turn on this option to automatically adjust the brightness of the backlight according to the content of the incoming signal. This optimizes the picture quality and decreases power consumption.

**Color Warmth** - This option allows you to select one of three automatic color adjustments: *Cool* for a bluer palette of picture colors; *Normal*; or *Warm* for a redder palette of color. The warm setting corresponds to the NTSC standard of 6500 K. Use the left or right arrow to make adjustments.

**Video Noise Reduction**- This setting reduces picture “static” or any type of interference. This feature is especially useful for providing a clearer picture in weak analog signal conditions. Press the right arrow to choose between these options:

**Low** for a softer, smoother picture that retains picture sharpness and detail.

**Medium** for a slightly softer picture than the *Low* setting.

**High** for an even softer, smoother picture than the other settings (the picture detail is somewhat decreased).

**OFF** turn off this function.

## Sound Menu

The Sound Menu lets you adjust audio output. To access the Sound Menu, press MENU on the remote, and then select *Sound* from the Main Menu. Press the OK button or right arrow to display options. The following audio items can be adjusted:

**Equalizer** The five-band graphic equalizer allows you to adjust the audio frequency settings. You can select one of the five-band equalizer presets or create your own personal preset.

**Sound Preset** Allows you to choose a specific Sound Preset. Press the right arrow to cycle through the options: *Standard*, *Movie*, *Voice*, *Music* and *Personal*.

**Frequency Range** Displays the different graphic equalizer bands set for each Sound Preset option. Choose a band and make adjustments. When you make adjustments, the Sound Preset option automatically changes to *Personal*. Press the left or right arrow to select the frequency (100Hz, 300Hz, 1KHz, 3KHz, 10KHz) you want to adjust. Use the up or down arrow to adjust the level. When you are done adjusting the levels, press the OK button to exit.

**Frequency Range** To view the frequency of another Sound Preset option, press the left or right arrow until no band is selected and *Frequency Range* is highlighted. Press the up arrow to highlight *Sound Preset*.

**Balance** Press the left or right arrow to adjust the level of audio sent to the left and right speakers.

**SRS TruSurround XT** Option: Creates a stunning 3D sound image from standard stereo material, with deep, rich bass enhancement and sharpened dialog audio. It processes any multichannel audio source into virtual surround sound from just two speakers or headphones.

**Analog TV Sound** Controls the manner in which the sound comes through the speakers. The available options vary according to the input selected.

**Mono** (available for regular TV viewing only) – This option plays the sound in mono only. Use this setting when receiving broadcasts with weak stereo signals.

**Stereo** – This option splits the incoming stereo audio signal into left and right channels. Most TV programs and recorded materials have stereo audio. The word “Stereo” appears in the Channel Banner when you tune to a program that is broadcast in stereo.

**Secondary Audio Program (SAP)** Plays the program’s audio in a second language, if one is available. The letters SAP appear in the channel banner when a program is broadcast with SAP information. SAP audio is broadcast in mono. SAP is also used to broadcast an audio description for the program for the visually impaired.

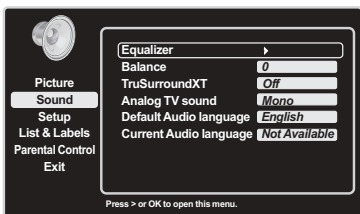

**Default Audio Language** Choose the language you prefer for dialog on digital channels. If the preferred language is not broadcast with the program, then the TV plays the default audio for the program (usually English in the U.S.). There are 16 available default languages.

**Current Audio Language (not available for analog channels)** – Press the right arrow to choose from the list of languages available for the program you're watching. The language chosen becomes your preferred language for all digital channels until you turn the TV off. If the language chosen is not being broadcast with a program, the TV plays the default language for the program (usually English in the US).

**Note:** This menu item grays out when the current channel selected is analog.

## Setup Menu

The Channel Setup Menu allows you to configure the TV with your preferences. Press MENU on the remote control; then select *Setup* from the Main Menu. Press OK or the right arrow to display options.

**Menu Language** Select the preferred language for the menus: *English, Espanol or Francais.*

**Signal Type** Choose the type of signal you have connected to the ANTENNA/CABLE INPUT.

**Channel Search** Searches for channels currently being received. See page 15 for more information.

### Closed Caption

Many programs are encoded with closed captioning information, which lets you display the audio portion of a program as text on the TV screen.

**Note:** Closed caption settings are not available for PC, HDMI 1, HDMI 2, HDMI 3, CMPT 1 and CMPT 2 INPUTS. These settings must be set in the connected component's menu. Closed captioning is not available on all channels at all times. Only specific programs are encoded with closed captioning information. When a program is closed captioned, CC is displayed in the Channel Banner. See Chapter 3 for more information about the Channel Banner.

The Closed Caption options are:

**CC Setting** Allows you to choose the way closed captioning information appears on the screen.

**Off** No captioning information displayed.

**On always** Captioning information shown always, when available.

**On when muted** Displays captioning information, when available, whenever the TV's sound is muted by pressing the MUTE button. The captioning information is not displayed when the sound is not muted.

**Analog CC Type** If available, this option allows you to select the captioning mode used for displaying captioning information. If you are unsure of the differences among the modes, you may prefer to leave the closed captioning mode set to CC1, which displays complete text of the program in the primary language in your area.

**Digital CC Type** If available, this allows you to select a closed caption service mode (1-6) for digital channels.

**Digital CC Preset** If available, this allows you to select between Default and Custom options.

Custom changes according to what you set for the options below.

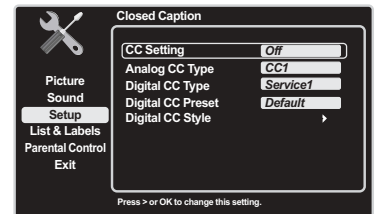
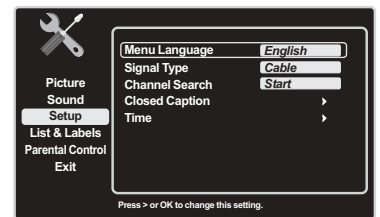

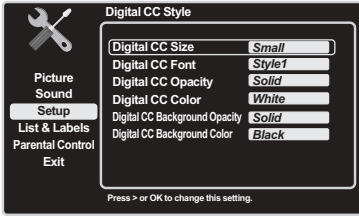

**Note:** These captioning style options only have an effect on true digital closed captions. Not all captioning on digital channels is digital captioning—it depends on what the broadcaster is sending. If the closed captioning for a program is not digital, the Digital CC style settings will not have an effect.

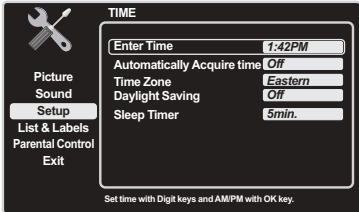

**Digital CC Style** If available, this allows you to customize the following display options:

**Digital CC Size** Allows you to set the size of the digital closed caption text: *Standard, Large* or *Small*.

**Digital CC Font** Allows you to select a character design for the digital closed caption text. A font is a complete assortment of letters, numbers, punctuation marks, etc, in a given design. Choose from a variety of fonts.

**Digital CC Opacity** Allows you to set the appearance of the digital closed caption text: *Solid, Transparent, Translucent* or *Flashing*.

**Digital CC Color** Allows you to choose the color of the digital closed caption text: *White, Red, Green, Blue, Yellow, Magenta, Cyan* or *Black*.

**Digital CC Background Opacity** Allows you to set the appearance of the space behind the digital closed caption text: *Solid, Transparent, Translucent* or *Flashing*.

**Digital CC Background Color** Allows you to choose the color of the area of the screen behind the digital closed caption text: *White, Red, Green, Blue, Yellow, Magenta, Cyan* or *Black*.

## TIME

**Enter Time** If you want to set the time manually, use the digit keys to set the hours and minutes. Press OK to select AM or PM.

**Automatically Acquire Time** Choose ON to acquire time automatically from digital channels.

**Time Zone** Select the current local time among *Eastern, Atlantic, Newfoundland, Samoa, Hawaii, Alaska, Pacific, Central* and *Mountain*.

**Daylight Saving** Choose OFF to ignore Daylight Savings information on digital channels. Otherwise, leave ON as the default choice.

**Sleep Timer** Use the left or right arrows to set the TV to turn off after a given amount of time.

## List & Labels Menu

Edit the channels in the list or choose labels for each video input channel. From the Main Menu, select List and Labels; press OK to display options.

**Channel Number** Press the CH+/CH- to select the channel number.

**In Channel List** If you've entered a channel you want to add to the channel list, highlight *In Channel List* and press the OK button or right arrow to place a check in the checkbox. If you've entered a channel you want to delete from the channel list, press the OK button or right arrow to uncheck the box.

**Label** You can edit the channel label. Press the OK button or right arrow to begin. Press the up or down arrow to edit the label. Press the left or right arrow to select the input field. Then, press the OK button to end editing.

**In Favorite Channel List** Press the OK button or right arrow to add or remove the selected channel from your list of favorite channels. Your Favorites List can include up to 10 channels.

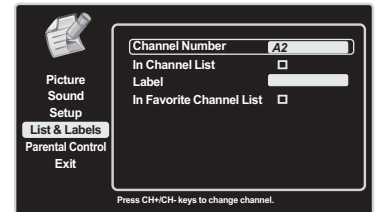

## Parental Control Menu

The Parental Control Menu is explained in Chapter 3 Go to Pages 20-24 for more information.

## 5 Other Information

---

### Frequently Asked Questions (FAQs)

#### **What's the quickest way to view High Definition (HD) video?**

Connect an off-air antenna to the ANTENNA/CABLE Input to view free local digital channels. You may need to purchase an antenna. (See page 8 for more information).

Visit [www.antennaweb.org](http://www.antennaweb.org) for assistance in deciding what type of antenna to use to receive the local digital channels available to you. By entering your location, this mapping program tells you which local analog and digital stations are available using a certain antenna.

#### **Are there other ways to view High Definition (HD) video?**

Besides using an off-air antenna as mentioned above, you can also use a set-top box to receive digital video. Contact your cable company or satellite provider to purchase digital programming and have them connect the box to ensure you are viewing channels the best way.

#### **How do I tell an analog channel from a digital channel?**

Press the INFO button to display the Channel Banner. Look at the bottom left corner of the screen. An "A" is displayed for an analog channel. A "D" is displayed for a digital channel.

#### **Why are there bars on my screen, and can I get rid of them?**

Most digital video is sent in a 16/9 format which fills your screen, but is sometimes sent in 4/3 which does not fill your screen. It depends on how the station or device connected to your TV is formatting the video. If there are bars on the screen, press the FORMAT button to try a different format that may eliminate the bars. Some bars can't be removed because of the way the format is sent by the broadcaster. The format changes as you press the FORMAT button and the format type is displayed at the bottom of the screen. For more information on screen formats, go to page 24.

#### **Why does channel search find a lot of channels, but when I try to tune to them, there's nothing there?**

Some channels enabled by the cable company don't carry programming, such as video ondemand. When channels are unavailable, your TV screen is blank or appears like snow. You probably want to remove these channels from your channel list. Remove these in the Channel List Menu. Go to page 29 for more information.

#### **Why does the first channel search take a long time?**

If you have both analog and digital channels, the TV is looking for all available channels in the channel list. If you do have digital channels, the TV is also searching for scrambled channels, non-scrambled channels, and each sub-channel of that digital channel.

# Troubleshooting

Most problems you encounter with your TV can be corrected by consulting the following troubleshooting list.

## TV Problems

### The TV won't turn on.

- Make sure the TV is plugged in.
- Check the wall receptacle (or extension cord) to make sure it is “live” by plugging in another device.
- The side panel controls may be locked (disabled). Use the remote control to unlock the side panel controls.
- Select the *Block Buttons* feature on the Parental Control Menu and press OK to uncheck the box.

### There is no picture and no sound but the TV is on.

- You may be tuned to an input with no component connected to it. If you're trying to view a connected component, press INPUT until the picture from that component appears.
- The *Signal Type* option may be set incorrectly. Go to page 15 for detailed instructions.
- The channel may be blank. Try changing channels.
- If you're watching your VCR and it's connected with coaxial cable to the ANTENNA/CABLE jack, tune the TV to channel 3 or 4 (whichever channel is selected on the 3/4 switch on the back of your VCR). Also make sure the TV/VCR button on the VCR is in the correct mode (press the TV/VCR button on your VCR).

### The sound is fine, but the picture is poor quality.

- If you're getting a black and white picture from a component you've connected to your TV, you might have your video cables connected to the wrong jacks. A yellow video cable connects to the yellow VIDEO INPUT jack on the side or back of your TV; three video cables or bundled component video cables (red, blue, and green) connect to the corresponding COMPONENT INPUT jacks on the back of your TV.
- Check the antenna connections. Make sure all of the cables are firmly connected to the jacks.
- Try adjusting the sharpness function to improve weak signals. Go to page 25 for more instructions.

### There is no sound, but the picture is fine.

- The sound might be muted. Try pressing the volume up button to restore sound.
- If using DVI, S-Video, or Y, PB, PR, remember to also connect the device's left and right audio output jacks to the TV's L and R AUDIO INPUT jacks.
- The sound settings may not be set correctly. Go to page 26 for more information.
- If your audio source has only one jack or is a (mono) audio source, make sure you have plugged the connection into the Left AUDIO INPUT jack on the TV.

### The screen is blank.

- Check your connections. If you used yellow, red, and white cables to connect, make sure they're connected to the yellow, red, and white VIDEO INPUT jacks on the side or back of the TV, not to the VIDEO OUTPUT jacks on the back of the TV.
- If you're trying to watch something that's playing on a component connected to the TV (like a DVD), press INPUT until you get to the correct video input channel.
- Make sure the component connected to the TV is turned on.
- Try another channel.

### **The buttons on the side panel don't work.**

- The side panel controls may be locked (disabled). Use the remote control to unlock the side panel controls by selecting the *Button Block* feature in the Parental Control Menu and press OK to uncheck the box.
- Unplug the TV for 10 minutes and then plug it back in. Turn the TV on and try again.

### **The TV turns off unexpectedly.**

- The electronic protection circuit may have been activated because of a power surge. Wait 30 seconds and then turn the TV on again. If this happens frequently, the voltage in your house may be abnormally high or low.
- Unplug. Wait 10 minutes. Plug in again.

### **You can't select a certain channel.**

- The channel may be blocked or not approved in the Parental Control Menu.
- If using a VCR, check to make sure the TV/VCR button on the VCR is in the correct mode (press the TV/VCR button on your VCR).
- Press the TV button and then try to change channels.

### **The stereo reception is noisy.**

- It may be a weak station. Use the Sound Menu and Sound Type to choose *Mono*.

### **A black box appears on the screen.**

- Closed captioning might be on. Check *Closed Caption* in the Setup menu. Go to page 27 for more instructions.

### **You are having problems with the HDMI Connection.**

- Make sure the HDMI or DVI component is turned on and the cables are firmly connected. If problems still occur, turn off your component and reconnect it. Reset the power by unplugging the power cord and plugging it back in.
- If you are tuned to the HDMI 1, HDMI 2, or HDMI 3 INPUT and you're receiving an *Unusable Signal* message onscreen, press the INFO button on the remote. If *Acquiring Channel* appears in the Channel Banner, the HDMI or DVI device isn't responding. Contact the manufacturer of the HDMI or DVI device for further assistance.
- If you tune to the HDMI 1, HDMI 2, or HDMI 3 INPUT and you see snow, the video goes in and out, or the video takes a long time to appear, your HDMI or DVI component is having trouble sending video information to the TV. Re-connect your device. Reset the power by unplugging the power cord and plugging it back in. If problems persist, try connecting the Y Pb Pr jacks if they are available or contact the manufacturer of the HDMI or DVI component for further assistance.
- If you have black bars on each side of your picture, the component you connected might have a switch or a menu option allowing you to change the picture quality output that will fix this. Choose either *720p* or *1080i*.



### **The Remote control doesn't work.**

- Something might be between the remote and the remote light sensor on the front of the TV. Make sure there is a clear path.
- The remote may not be aimed directly at the TV.
- The batteries in the remote may be weak, dead, or installed incorrectly. Put new batteries in the remote.

### **The Universal Remote control doesn't work.**

- This TV utilizes new remote control signal codes and may not be compatible with your existing universal remote (e.g. satellite box remotes, cable box remotes, generic universal remotes, etc.). Over time, newer universal remote controls that become available should pick up the new TV codes.

### **You are experiencing problems with V-Chip/Parental Controls.**

- If the rating limits don't work, you must lock the settings. Go to the Main Menu (press MENU on your remote), select *Parental Control*, select *Lock Parental Control*.

### **The V-Chip won't let me watch a program, even though it's not rated as violent.**

- Maybe the movie was given an NR (Not Rated) status. After you block movie ratings, you must set NR to *View Separately* in order to view movies with an NR rating.

### **What else can I do?**

If you've been through the Troubleshooting section and nothing has fixed your problem, try rebooting your TV. Note that after a reboot, you may need to run your TV through the setup process again. To reboot, unplug the power cord from the wall outlet or power strip. Keep your TV unplugged for about 5 minutes. Then plug in the TV and turn it on. See if the problem is fixed. If the problem remains, then please click on the Customer Support Menu at [www.rca.com/television](http://www.rca.com/television) for updated FAQs or contact RCA Customer Support at the support number provided in your Warranty under *How To Get Service*.

# V-Chip Rating Explanations

## US V-Chip Rating System

**TV-MA (Mature Audience Only)** Specifically designed to be viewed by adults and may be unsuitable for children under 17. It contains one or more of the following content themes: crude indecent language (L), explicit sexual activity (S), or graphic violence (V).

**TV-14 (Parents Strongly Cautioned)** Contains some material that many parents would find unsuitable for children under 14. Parents are strongly urged to exercise greater care in monitoring this program and are cautioned against letting children under the age of 14 watch unattended. This program contains one or more of the following content themes: intensely suggestive dialogue (D), strong coarse language (L), intense sexual situations (S), or intense violence (V).

**TV-PG (Parental Guidance Suggested)** Contains material that parents may find unsuitable for younger children. Many parents may want to watch it with their younger children. The program contains one or more of the following content themes: some suggestive dialogue (D), infrequent coarse language (L), some sexual situations (S), or moderate violence (V).

**TV-G (Parental Audience)** Most parents would find this program suitable for all ages. It contains little or no sexual dialogue (D) or situations (S), no strong language (L), and little or no violence (V).

**TV-Y7 (Directed to Children 7 years and older)** Designed for children ages 7 and above. It may be more appropriate for children who have acquired the developmental skills needed to distinguish between make believe and reality. Themes and elements in this program may include mild fantasy violence (FV) or comedic violence, or may frighten children under the age of 7.

**TV-Y (All Children)** Themes and elements in this program are designed for a young audience, including children ages 2-6. It is not expected to frighten younger children.

## Canadian English V-Chip Rating System

**18+ (Adult)** Programming intended for adults 18 and older. It may contain elements of violence, language, and sexual content which could make it unsuitable for viewers under 18. Violence Guidelines: May contain violence integral to the development of the plot, character or theme, intended for adult audiences. Other Content Guidelines: May contain graphic language and explicit portrayals of nudity and/or sex.

**14+ (Viewer 14 and over)** Programming contains themes or content which may not be suitable for viewers under the age of 14. Parents are strongly cautioned to exercise discretion in permitting viewing by pre-teens and early teens. Violence Guidelines: May contain intense scenes of violence. Could deal with mature themes and societal issues in a realistic fashion. Other Content Guidelines: May contain scenes of nudity and/or sexual activity. There could be frequent use of profanity.

**PG (Parental Guidance)** Programming intended for a general audience but which may not be suitable for younger children (under the age of 8). Parents may consider some content inappropriate for unsupervised viewing by children aged 8-13. Violence Guidelines: Depictions of conflict and/or aggression will be limited and moderate; may include physical, fantasy, or supernatural violence. Other Content Guidelines: May contain infrequent mild profanity, or mildly suggestive language. Could also contain brief scenes of nudity.

**G (General Audience)** Programming considered acceptable for all ages groups. While not designed specifically for children, it is understood younger viewers may be part of the audience. Violence Guidelines: Will contain very little violence, either physical or verbal or emotional. Will be sensitive to themes which could frighten a younger child, will not depict realistic scenes of violence which minimize or gloss over the effects of violent acts. Other Content Guidelines: There may be some inoffensive slang, no profanity and no nudity.

**C8+ (Children 8 and older)** Programming generally considered acceptable for children 8 years and over to watch on their own. Violence Guidelines: Violence will not be portrayed as the preferred, acceptable, or only way to resolve conflict or encourage children to imitate dangerous acts which they may see on television. Any realistic depictions of violence will be infrequent, discreet, of low intensity and will show the consequences of the acts. Other Content Guidelines: There will be no profanity, nudity or sexual content.

**C (Children)** Programming intended for children under age 8. Violence Guidelines: Careful attention is paid to themes which could threaten children's sense of security and well being. There will be no realistic scenes of violence. Depictions of aggressive behavior will be infrequent and limited to portrayals that are clearly imaginary, comedic or unrealistic in nature. Other Content Guidelines: There will be no offensive language, nudity or sexual content.

### Canadian French V-Chip Rating System

**18+ (Adult)** Programming is for adults only. This program contains sustained violence or extremely violent scenes.

**16+ (Viewer 16 and over)** Programming is not suitable for those under age 16. This program contains frequent scenes of violence or intensely violent scenes.

**13+ (Viewer 13 and over)** Programming may not be suitable for children under the age of 13. This program either contains several violent scenes or one or more scenes that are violent enough to affect them. Viewing in the company of an adult is therefore strongly recommended for children under the age of 13.

**8+ (Viewer 8 and over)** Not recommended for young children. This program is suitable for most audiences, but it contains mild or occasional violence that could upset young children. Viewing in the company of an adult is therefore recommended for young children (under the age of 8) who do not distinguish between reality and imagination.

**G (General Audience)** This program is suitable for audiences of all ages. It contains no violence, or any violence that it does contain is either minimal or is presented in a humorous manner, as a caricature, or in an unrealistic way.

## Television Specification

<b>Broadcasting system</b>	US System NTSC-M ATSC standard (8VSB), QAM
<b>Receiving Channels</b>	VHF 2-13 UHF 14-69 CATV 14-36 (A)-(W) 37-59 (AA)-(WW) 60-85 (AAA)-(ZZZ) 86-94 (86)-(94) 95-99 (A-5)-(A-1) 100-135 (100)-(135) 01 (4A)
<b>Tuner type</b>	Frequency synthesized

# TTE Technology, Inc. (“TTE”) Limited Warranty

## All LCD Models

**EXCEPT TO THE EXTENT PROHIBITED BY APPLICABLE LAW, THIS WARRANTY DOES NOT COVER, AND AS DESCRIBED BELOW TTE EXPRESSLY DISCLAIMS, ALL ACTUAL AND IMPLIED WARRANTIES WITH RESPECT TO ANY PRODUCT USED FOR INSTITUTIONAL OR OTHER COMMERCIAL PURPOSES (INCLUDING BUT NOT LIMITED TO RENTAL PURPOSES).**

**What your warranty covers:** Defects in materials or workmanship to the original owner

### New LCD Televisions - Screen Sizes 32” and smaller:

#### For how long after your purchase:

- Ninety (90) days from date of purchase for labor charges. After ninety (90) days, labor charges will be at owner expense.
- One (1) year from date of purchase for parts.

#### What we will do:

- At TTE’s discretion, pay an Authorized RCA Service Center for both labor charges and parts to repair your television, or replace your television with a new or refurbished/remanufactured unit. See “How to get service”

### New LCD Televisions - screen sizes 33” through 47”:

#### For how long after your purchase:

- One (1) year from the date of purchase for labor charges.
- One (1) year from the date of purchase for parts.

#### What we will do:

- At TTE’s discretion, pay an Authorized RCA Service Center for labor charges and parts to repair your television, or replace your television with a new or refurbished/remanufactured unit. See “How to get service”

### All Remanufactured/Refurbished LCD Televisions:

#### For how long after your purchase:

- Ninety (90) days from date of purchase for labor charges.
- Ninety (90) days from date of purchase for parts.

#### What we will do:

- At TTE’s discretion, pay an Authorized RCA Service Center for both labor charges and parts to repair your television, or replace your television with a refurbished/remanufactured unit. See “How to get service”

### How to get service:

- Call **1-800-951-9582**. Please have your unit’s date of purchase and model/serial number ready. The model/serial number information can be found on the back of your unit.
- A representative will troubleshoot your problem over the phone.
- If it is determined that your unit requires service, the service location will be at the sole discretion of TTE based upon the TTE Limited Warranty statement.
- At the sole discretion of TTE, television screen sizes 32” and smaller is either consumer carry-in to an Authorized RCA Service Center or directly exchanged for a new or refurbished/remanufactured unit.
- At the sole discretion of TTE, television screen sizes 33” through 47” is either consumer carry-in to an Authorized RCA Service Center or directly exchanged for a new or refurbished/remanufacture unit.
- Proof of purchase in the form of a bill of sale or receipted invoice from an Authorized Dealer which is evidence that the product is within the warranty period must be presented to obtain warranty service.

### **What your warranty does not cover:**

- Customer instruction. (Your Owner's Manual describes how to install, adjust, and operate your unit. Any additional information should be obtained from your dealer.)
- Installation and related adjustments.
- Damage resulting from non-approved installation methods.
- Signal reception problems not caused by your unit.
- Damage from misuse or neglect.
- Batteries.
- A television that has been modified or incorporated into other products or is used for institutional or other commercial purposes (including but not limited to rental purposes).
- A unit purchased or serviced outside the USA.
- Acts of nature, such as but not limited to lightning damage.
- Special, incidental or consequential damages.

### **Product Registration:**

Please complete and mail the Product Registration Card packed with your unit or register on-line at [www.rca.com/television](http://www.rca.com/television). It will make it easier to contact you should it ever be necessary. The return of the card is not required for warranty coverage.

### **Limitation of Warranty:**

- **THE WARRANTY STATED ABOVE IS THE ONLY WARRANTY APPLICABLE TO THIS PRODUCT. NO VERBAL OR WRITTEN INFORMATION GIVEN BY TTE TECHNOLOGY, INC., ITS AGENTS OR EMPLOYEES SHALL CREATE A GUARANTY OR IN ANY WAY INCREASE OR MODIFY THE SCOPE OF THIS WARRANTY.**
- **REPAIR OR REPLACEMENT AS PROVIDED UNDER THIS WARRANTY IS THE EXCLUSIVE REMEDY OF THE CONSUMER. TTE TECHNOLOGY, INC. SHALL NOT BE LIABLE FOR SPECIAL, INCIDENTAL OR CONSEQUENTIAL DAMAGES RESULTING FROM THE USE OF THIS PRODUCT OR ARISING OUT OF ANY BREACH OF ANY EXPRESS OR IMPLIED WARRANTY ON THIS PRODUCT. THIS DISCLAIMER OF WARRANTIES AND LIMITED WARRANTY ARE GOVERNED BY THE LAWS OF THE STATE OF INDIANA. EXCEPT TO THE EXTENT PROHIBITED BY APPLICABLE LAW, ANY IMPLIED WARRANTY OF MERCHANTABILITY OR FITNESS FOR A PARTICULAR PURPOSE ON THIS PRODUCT IS LIMITED TO THE APPLICABLE WARRANTY AND WARRANTY PERIOD SET FORTH ABOVE.**

### **How State Law relates to this warranty:**

- Some states do not allow the exclusion nor limitation of incidental or consequential damages, or limitations on how long an implied warranty lasts, so the above limitations or exclusions may not apply to you.
- This warranty gives you specific legal rights, and you also may have other rights that vary from state to state.

### **If you purchased your unit outside the United States or seek warranty coverage outside the United States:**

This warranty does not apply. Contact your dealer for warranty information.

**Service calls which do not involve defective materials or workmanship are not covered by this warranty. Costs of such service calls are the sole responsibility of the purchaser.**

# TTE Technology Canada Ltd. (“TTE”) Limited Warranty

## Limited Warranty

**EXCEPT TO THE EXTENT PROHIBITED BY APPLICABLE LAW, THIS WARRANTY DOES NOT COVER, AND AS DESCRIBED BELOW TTE EXPRESSLY DISCLAIMS, ALL ACTUAL AND IMPLIED WARRANTIES AND CONDITIONS WITH RESPECT TO ANY PRODUCT USED FOR INSTITUTIONAL OR OTHER COMMERCIAL PURPOSES (INCLUDING BUT NOT LIMITED TO RENTAL PURPOSES).**

### What your warranty covers:

- Defects in materials or workmanship to the original purchaser.

### For how long after purchase:

- All RCA televisions: One year parts and labour.
- All RCA Scenium televisions: Two years parts and labour.

### What TTE Technology Canada Ltd. will do:

At TTE’s discretion, pay an Authorized RCA Service Centre for both labor charges and parts to repair your television, or replace your television with a new or refurbished/remanufactured unit. See “How to get service”

### How to get service:

- Call 1-800-951-9582. Please have your unit’s date of purchase and model/serial number ready. The model/serial number information can be found on the back of your unit.
- A representative will troubleshoot your problem over the phone.
- If it is determined that your unit requires service, the service location will be at the sole discretion of TTE based upon the TTE Limited Warranty statement.
- At the sole discretion of TTE, RCA CRT DV televisions are either consumer carry-in to an Authorized RCA Service Centre or directly exchanged for a new or refurbished/remanufactured unit.
- At the sole discretion of TTE, RCA LCD televisions are either consumer carry-in to an Authorized RCA Service Centre, directly exchanged for a new or refurbished/remanufacture unit or provided in-home service.
- At the sole discretion of TTE, RCA Scenium LCD televisions are either consumer carry-in to an Authorized RCA Service Centre, directly exchanged for a new or refurbished/remanufacture unit or provided in-home service.
- Proof of purchase in the form of an original bill of sale or receipted invoice from an Authorized Dealer which is evidence that the product is within the warranty period must be presented to obtain warranty service.

### Your warranty does not cover damages which are caused by:

- Fire, accident, lightening, flood and/or other acts of God;
- Faulty installation, set-up adjustments, improper antenna, inadequate signal reception, adjustment of consumer controls and/or improper maintenance; and/or
- Failure which results from misuse, abuse, neglect, mishandling, misapplication, and/or alteration.

**What your warranty does not cover:**

- Customer instruction (Your Owner's Manual describes how to install, adjust, and operate your unit. Any additional information should be obtained from your dealer);
- Transportation cost to and from the Service Centre (Unless you have made other arrangements with your dealer at the time of purchase whereby he undertakes this responsibility);
- Installation and set-up service adjustments;
- Products connected otherwise than as outlined in the Owner's Manual;
- Products on which the serial number has been altered or removed;
- External antenna or cable systems;
- Remote control batteries;
- A television that has been modified or incorporated into other products or is used for institutional or other commercial purposes (including but not limited to rental purposes);
- A unit purchased or serviced outside Canada;
- Special, incidental or consequential damages; and/or
- Normal wear or cosmetic damage.

**How Provincial law relates to this warranty:**

This warranty gives you specific legal rights, which are in addition to statutory warranties, which may vary from Province to Province and which take precedence over the terms of this warranty.

**If you purchased your unit outside of Canada:**

This warranty does not apply. Contact your dealer for warranty information.

©2009 TTE Technology Canada Ltd.

6605 Hurontario Street, Mississauga, Ontario L5T 0A3

## Care and Cleaning

*Caution:* Turn OFF your TV before cleaning.

You can clean the TV as required, using a soft lint-free cloth. Be sure to occasionally dust the ventilation slots in the cabinet to help assure adequate ventilation.

**IMPORTANT: Never use strong cleaning agents, such as ammonia-based cleaners, or abrasive powder. These types of cleaners will damage the TV. The TV's screen may be cleaned with a soft, lint-free cloth as well. Take care not to scratch or mar the screen. If necessary, you may use a cloth dampened with warm water. While cleaning, do not spray liquid directly on the screen, or allow liquid to run down the screen and inside the TV. Also, never place drinks or vases with water on top of the TV. This could increase the risk of fire, shock hazard or damage to the TV.**



**ENERGY STAR** is a set of power-saving guidelines issued by the U.S. Environmental Protection Agency (EPA).

Manufactured under license from Dolby Laboratories.

"Dolby" and the double-D symbol are registered trademarks of Dolby Laboratories.

**SRS**  is a trademark of SRS Labs, Inc.

TruSurround XT technology is incorporated under license from SRS Labs, Inc.

## **FCC Information**

This equipment has been tested and found to comply with the limits for a Class B digital device, pursuant to Part 15 of the FCC Rules. These limits are designed to provide reasonable protection against harmful interference in a residential installation. This equipment generates, uses, and can radiate radio frequency energy and, if not installed and used in accordance with the instructions, may cause harmful interference to radio communications. However, there is no guarantee that interference will not occur in a particular installation. If this equipment does cause harmful interference to radio or television reception, which can be determined by turning the equipment off and on, the user is encouraged to try to correct the interference by one or more of the following measures:

- Reorient or relocate the receiving antenna.
- Increase the separation between the equipment and receiver.
- Connect the equipment into an outlet on a circuit different from that to which the receiver is connected.
- Consult the dealer or an experienced radio/TV technician for help.

This Class B digital apparatus complies with Canadian ICES-003.

For assistance, visit the RCA website at [www.rca.com/tv](http://www.rca.com/tv) or call 1-877-794-7977.

Please do not send any products to the Indianapolis address listed in this manual or on the carton. This will only add delays in service for your product.

# **TTE**

**TTE Technology, Inc.**

**5541 West 74th Street**

**Indianapolis, IN 46268**

**©2009 TTE Technology, Inc.**

**RCA and associated marks are trademarks of THOMSON S.A.**

**used under license to TTE Corporation.**

**Printed in USA**

**Part No.: 72-RS95NA-E003B**