

RCA

HDTV Monitor User's Guide



Changing Entertainment. Again.

GUIDE *plus*TM
GOLD
GEMSTAR

Important Information

WARNING

To reduce the risk of fire or electric shock, do not expose this product to rain or moisture.

CAUTION

RISK OF ELECTRIC SHOCK
DO NOT OPEN

Caution: To reduce the risk of electric shock, do not remove cover (or back). No user serviceable parts inside. Refer servicing to qualified service personnel.



This symbol indicates "dangerous voltage" inside the product that presents a risk of electric shock or personal injury.



This symbol indicates important instructions accompanying the product.

Refer to the identification/rating label located on the back panel of your product for its proper operating voltage.

FCC Regulations state that unauthorized changes or modifications to this equipment may void the user's authority to operate it.

Caution: Using video games or any external accessory with fixed images for extended periods of time can cause them to be permanently imprinted on the picture tube (or projection TV picture tubes). ALSO, some network/program logos, phone numbers, etc. may cause similar damage. This damage is not covered by your warranty.

Cable TV Installer: This reminder is provided to call your attention to Article 820-40 of the National Electrical Code (Section 54 of the Canadian Electrical Code, Part 1) which provides guidelines for proper grounding and, in particular, specifies that the cable ground shall be connected to the grounding system of the building as close to the point of cable entry as practical.

Product Registration

Please fill out the product registration card (packed separately) and return it immediately. Returning the card allows us to contact you if needed.

Product Information

Keep your sales receipt to obtain warranty parts and service and for proof of purchase. Attach it here and record the serial and model numbers in case you need them. These numbers are located on the product.

Model No. _____

Serial No. _____

Purchase Date: _____

Dealer/Address/Phone: _____

G-LINK, VCR Plus+, C³, PlusCode, GUIDE Plus+, and GUIDE Plus+ Gold are trademarks of Gemstar Development Corporation.

The GUIDE Plus+ Gold system is manufactured under license from Index Systems Inc.

THOMSON MULTIMEDIA INC. AND GEMSTAR ARE NOT IN ANY WAY LIABLE FOR THE ACCURACY OF THE PROGRAM INFORMATION PROVIDED BY THE GUIDE PLUS+ SYSTEM. IN NO EVENT SHALL THOMSON MULTIMEDIA OR GEMSTAR BE LIABLE FOR ANY AMOUNT REPRESENTING LOSS OF PROFITS, LOSS OF BUSINESS, OR INDIRECT, SPECIAL, OR CONSEQUENTIAL DAMAGES IN CONNECTION WITH THE PROVISION OR USE OF ANY INFORMATION EQUIPMENT, OR SERVICES RELATING TO THE GUIDE PLUS+ SYSTEM.

Key Features Overview

Your TV is equipped with features that will add to your TV viewing experience. The following information summarizes a few of these features. Chapter 3 provides more information about the rest of the TV's features and how to use them.



On-screen Program Guide

Description: The GUIDE Plus+ system is an on-screen interactive list of programs and information that is built into your TV. You can scroll through the guide to see what's on and tune directly to that program from the guide. You can also browse programs by category with the *Sort* feature.

When you access the *News* feature, MSNBC will appear in your video window if available and display current news stories by headline.

One-Touch VCR Recording is another benefit of the GUIDE Plus+ system. You don't have to remember to program your VCR or use the menus in your VCR to set up a recording.

Requirements:

- If there is a Demo Pin in the G-LINK jack on the back of the TV, remove it.
- Complete the on-screen interactive setup. You'll find detailed instructions in Chapter 1.
- One-Touch VCR Recording: You must connect the G-LINK cable to the TV and place one of the wands in front of the remote sensor on the VCR.
- If you have a cable box, connect the G-LINK cable to the TV and place one of the wands in front of the remote sensor on the cable box.

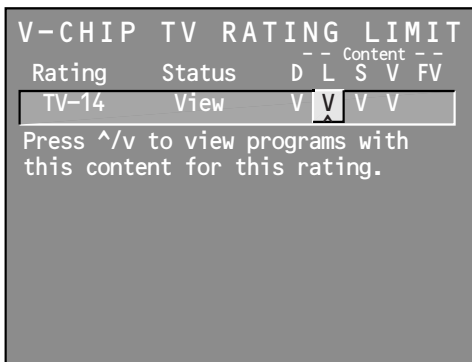

V-Chip: Parental Controls

Description: You can block programs and movies by content, age-based ratings, and/or movie ratings.

Requirements:

- Set up the *Parental Controls* menu in the TV's main menu (Chapter 3 has details).
- The broadcasters must use the rating system when they send the program to your TV in order for your TV to block the program.
- Parental controls must be locked for these settings to take affect.



16:9 Mode

Description: Lets you select a widescreen format for a wider viewing area using a 16:9 aspect-ratio source, such as a DVD player, for display on this 4:3 aspect-ratio TV.

Requirements:

- A 16:9 aspect-ratio source, such as a DVD player or HD receiver.
- A 16:9 aspect-ratio disc or signal.
- The 16:9 source needs to be set to output a 16:9 format signal.
- The 16:9 mode on the TV needs to be on.

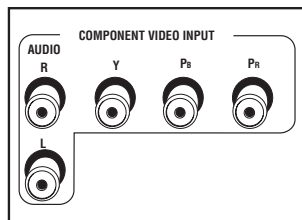
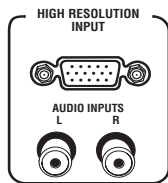

High Resolution Input and Component Video Input Jacks

Description: The HIGH RESOLUTION INPUT jack allows you to connect your TV to an RGB device or component video device (Y•Pb•Pr) (with the supplied adapter cable). The component video inputs can be used to connect a component video device directly.

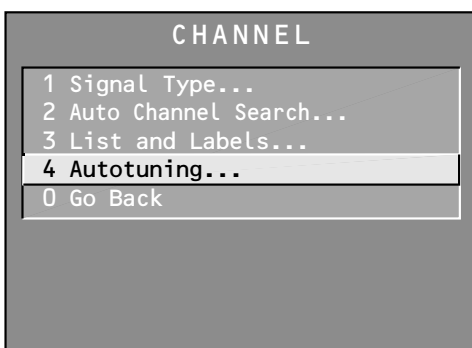

Autotuning

Description: Allows you to set up the TV to automatically tune to a specific channel when you press a certain component button on the remote (VCR1, DVD, etc.).

Requirement: Set up *Autotuning* in the TV's menu system. (Chapter 3 has details).

Introduction

Key Features Overview	1
On-screen Program Guide	1
V-Chip: Parental Controls	1
16:9 Mode	2
High Resolution Input and Component Video Input Jacks	2
Autotuning	2

Chapter 1: Connections & Setup

Things to Consider Before You Connect	6
Protect Against Power Surges	6
Protect Components from Overheating	6
Position Cables Properly to Avoid Audio Interference	6
Important Stand and Base Safety Information	6
Use Indirect Light	6
Demo Pin	6
Choose Your Connection	7
Cables Needed to Connect Components to Your TV	7
How to Connect: TV + HD Receiver + VCR + DVD Player	8
How to Connect: TV + Satellite Receiver + VCR	10
How to Connect: TV + DVD + VCR	11
How to Connect: A/V Receiver + Speakers	12
Explanation of Input Jacks and Cables	13
Why You Should Connect the G-LINK Cable	15
How to Find the Remote Sensor	15
Placing the G-LINK Wands	15
The Front of Your TV	16
Front Inputs	16
Front Panel	16
Plug in the TV	17
Place batteries in the remote	17
Turn on the TV	17
Complete the Interactive Setup	18
Set the Menu Language	18
Complete Auto Channel Search	18
The GUIDE Plus+ System Setup	19
What to Expect	23
Next Steps	23

Chapter 2: Using the Remote Control

The Buttons on the Remote Control	26
Using the INPUT Button	27
Programming the Remote to Operate Other Components	28
Find Out If You Need to Program the Remote	28
Programming the Remote	28
How to Use the Remote After You've Programmed It	30

Table of Contents

Chapter 3: Using the TV's Features

About the GUIDE Plus+ System	34
Downloading Data	34
Getting In & Out of the GUIDE Plus+ System	35
The GUIDE Plus+ System Menus	35
Grid Guide	35
Sort	37
News	38
Schedule	38
Messages	39
Editor	40
Setup	40
How to Get More Information About an Advertisement or a Program	41
GUIDE Plus+ Menu Items	41
Channel Banner	42
Why You Should Use the Autotuning Feature	43
How to Set Up the Autotuning Feature	43
Parental Controls and V-Chip	45
How V-Chip Works	45
V-Chip TV Rating Limit	46
Blocking Specific Content Themes	48
Viewing Specific Content Themes	49
V-Chip Movie Rating Limit	50
V-Chip Unrated Program Block	51
Channel Block	51
Front Panel Block	51
Lock/Unlock Parental Controls	51
PIP (Picture-in-Picture) Operation	52
PIP Buttons.....	52
Tips for Using the PIP Buttons	52

Chapter 4: Using the TV's Menu System

How to Use Your TV's Menu System	54
Audio Menu	54
Picture Quality Menu	55
Screen Menu	56
Using Closed Captioning	57
Channel Menu	58
Time Menu	58

Chapter 5: Other Information

Troubleshooting	60
RCA HDTV Monitor Specifications	63
Care and Cleaning	64
Limited Warranty	65
Index	74

Connections & Setup

Chapter Overview:

- Things to Consider Before You Connect
- Choose Your Connection
- Connections
- Explanation of Input Jacks and Cables
- Why You Should Connect the G-LINK Cable
- The Front of Your TV
- Plug in the TV
- Put Batteries in the Remote
- How to Use the Remote Control to Complete the Interactive Setup
- Turn on the TV
- Complete the Interactive Setup

Changing Entertainment. Again.



Connections & Setup

Things to Consider Before You Connect

Protect Against Power Surges

- Connect all components before you plug any of their power cords into the wall outlet.
- Turn off the TV and/or component before you connect or disconnect any cables.
- Make sure all antennas and cables are properly grounded. Refer to the Important Safeguards sheet packed with your TV.

Protect Components from Overheating

- Don't block ventilation holes on any of the components. Arrange the components so that air can circulate freely.
- Don't stack components.
- When you place components in a stand, make sure you allow adequate ventilation.
- If you connect an audio receiver or amplifier, place it on the top shelf so the heated air from it won't flow around other components.

Position Cables Properly to Avoid Audio Interference

- Insert each cable firmly into the designated jack.
- If you place components above the TV, route all cables down the side of the back of the TV instead of straight down the middle of the TV.
- If your antenna uses 300-ohm twin lead cables, do not coil the cables. Also, keep the twin lead cables away from audio/video cables.

Important Stand and Base Safety Information

Choose the location for your TV carefully. Place the TV on a stand or base that is of adequate size and strength to prevent the TV from being accidentally tipped over, pushed off, or pulled off. This could cause personal injury and/or damage the TV. Refer to the Important Safeguards sheet packed with your TV.

Use Indirect Light

Don't place the TV where sunlight or room lighting will be directed toward the screen. Use soft or indirect lighting.





Demo Pin

If there is a demo pin in the G-LINK jack on the back of the TV, you must remove it before you connect the G-LINK cable. If there is no demo pin, just insert the G-LINK cable into the G-LINK jack.

Choose Your Connection

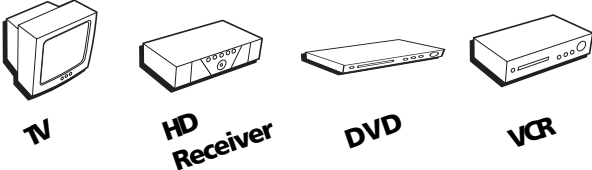
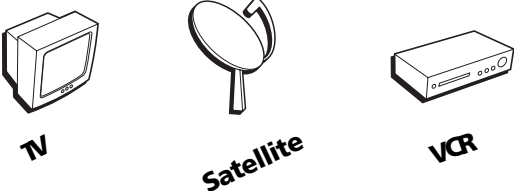
There are several ways to connect your TV. Please use the following chart to determine which connection is best for you. Proceed to the appropriate page and connect your TV.

Components	Cables Needed	Connection Title	Go to...
 <p>TV HD Receiver DVD VCR</p>	<p>Coaxial Audio/video G-LINK cable RGB cable</p>	<p>TV + HD Receiver + DVD + VCR</p>	<p>page 8</p>
 <p>TV Satellite VCR</p>	<p>Coaxial Audio/video G-LINK cable</p>	<p>TV + Satellite Receiver + VCR</p>	<p>page 10</p>
 <p>TV DVD VCR</p>	<p>Coaxial Audio/video G-LINK cable</p>	<p>TV + DVD + VCR</p>	<p>pages 11</p>

Cables Needed to Connect Components to Your TV

The pictures below show the cables needed for the connections represented in this book.

Note: Please locate the G-LINK cable (provided) when you're getting ready to set up your TV. You need to connect this cable to your TV and to your VCR and/or cable box in order for all of the features of the program guide to work properly.

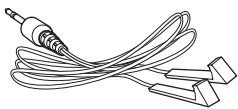

G-LINK cable

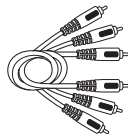

Audio/Video cables



Coaxial cable

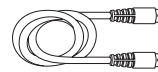

S-Video cable

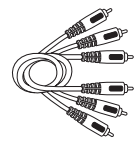

Component Video (Y•Pb•Pr) cables

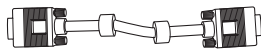

High Resolution (RGB to RGB) cable

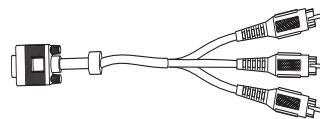

High Resolution to Component Video adapter (RGB to Y•Pb•Pr) cable

Connections & Setup

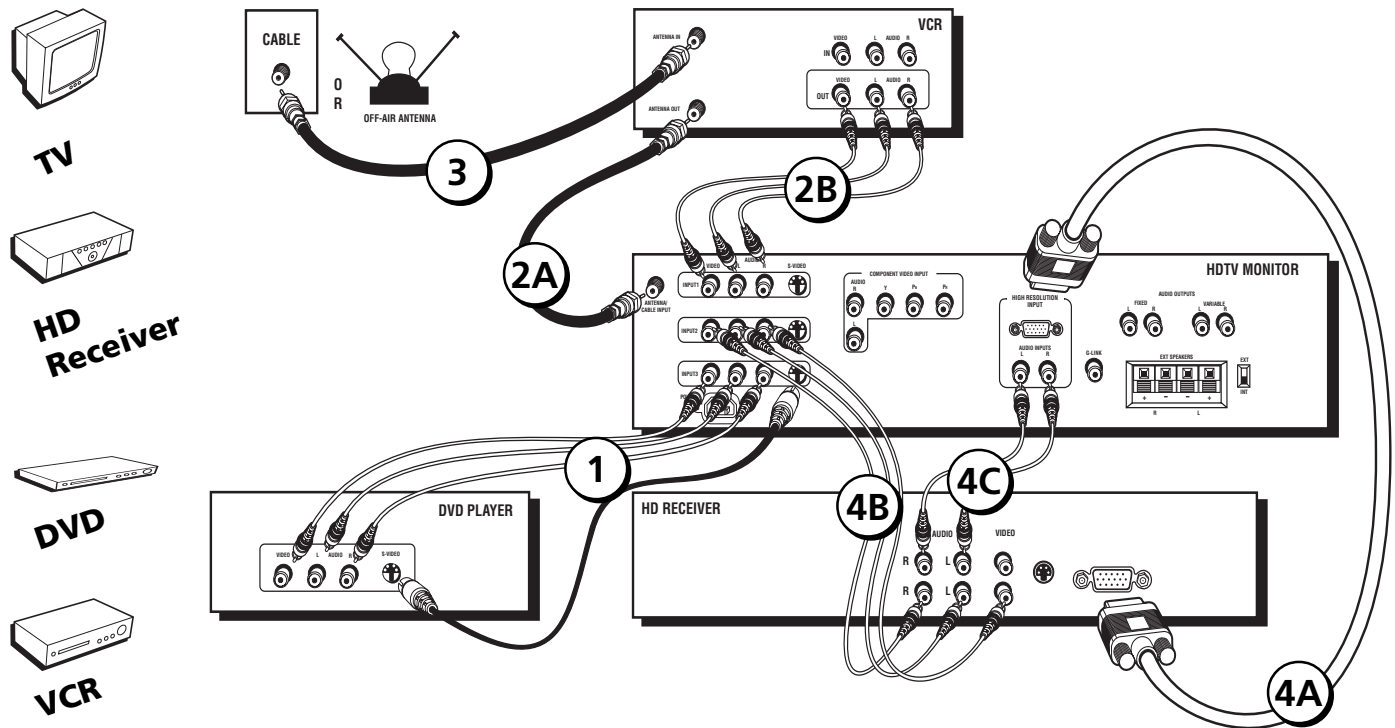

How to Connect: TV + HD Receiver + VCR + DVD Player

1. Connect your DVD Player to your TV.

- A. Connect the DVD player's audio/video output to INPUT3 on the TV using audio/video cables. If your DVD player has an S-Video output, you can make the video connection by using the S-Video jacks instead.

Notes:

- If you are using an S-Video cable, you must also use audio cables. The S-Video cable only transfers video information.
- If your DVD player has a component video output, we recommend you use the component video input on the TV instead of the standard video or S-Video connection.

2. Connect your VCR to your TV.

- A. Connect a coaxial cable to the VCR's antenna output and to the ANTENNA/CABLE INPUT jack on the TV.
B. Connect the VCR's audio/video output to INPUT1 on the TV using audio/video cables.

3. Make sure cable or antenna is connected to your VCR.

- A. Connect the coaxial cable carrying your television signal (off-air or cable) to the antenna input on the VCR.

4. Connect your HD Receiver to your TV.

A. Connect the supplied high resolution cable to your HD receiver and to the HIGH RESOLUTION INPUT on the TV.

Note: Due to copyright restrictions, you may not be able to view some high definition programs in high definition format using this product. To view material in standard definition instead, you also must connect the Audio/Video jacks to the TV.

B. Connect audio/video cables from the HD receiver's AUDIO OUT (R and L) and VIDEO jacks to the INPUT2 AUDIO and VIDEO IN jacks on the TV.

C. Connect audio cables from the HD receiver's AUDIO OUT (R and L) jacks to the TV's HIGH RESOLUTION AUDIO IN (R and L) jacks.

D. Connect an optional S-Video cable from the HD receiver's S-VIDEO jack to the TV's S-VIDEO jack.

Note: If you are using an S-Video cable, you must also use audio cables. The S-Video cable only transfers video information.

Viewing the Components

1. Turn on the TV and the component(s) you want to view.
2. Press the TV button on the remote control.
3. Press the INPUT button on the remote control to scroll through the video inputs.
 - The VCR can be viewed on the VID1 input channel.
 - The HD receiver can be viewed on the HiRes (recommended) or VID2 input channel.
 - The DVD player can be viewed on the VID3 input channel.

Notes:

- You can set up the TV to automatically tune to the correct input channel. This is called Autotuning. (See Chapter 3 for more information.)
- The TV automatically detects when a component is connected to the HIGH RESOLUTION INPUT jack. To connect a component video device to this jack, you need to use the supplied RGB-component video adapter cable. The TV automatically detects and displays the component video signal.

Important: If your RCA or PROSCAN HD receiver switches from a high definition output to a standard definition output, you will need to switch from the high resolution input channel to the standard definition INPUT2 (VID2) channel in order for you to view the signal. There are two situations in which this would occur:

- When recording from the HD receiver
- When a high definition output signal is not allowed by the program provider and/or movie studio for that particular program

Go to page 15

Connections & Setup

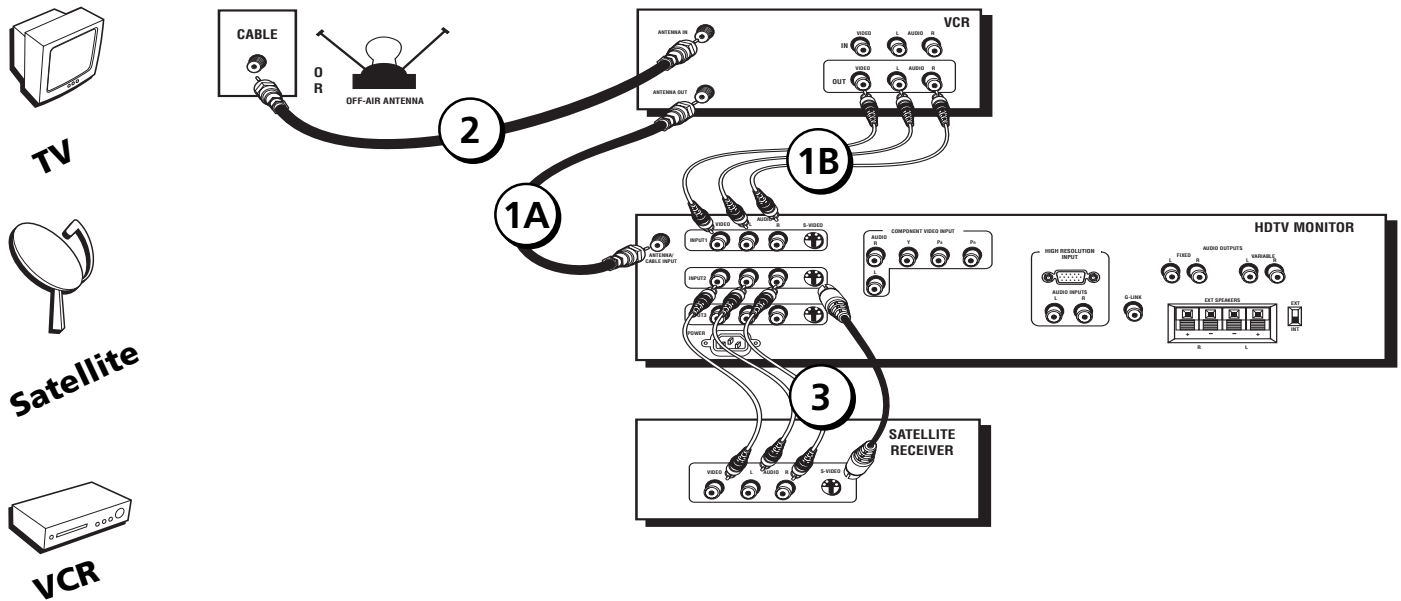

How to Connect: TV + Satellite Receiver + VCR

1. Connect your VCR to your TV.

- Connect a coaxial cable to the VCR's antenna output and to the ANTENNA/CABLE INPUT jack on the TV.
- Connect the VCR's audio/video output jacks to the INPUT1 AUDIO (R and L) and VIDEO jacks on the TV using audio/video cables.

2. Make sure cable or antenna is connected to your VCR.

- Connect the coaxial cable carrying your television signal (off air or cable) to the antenna input on the VCR.

3. Connect your Satellite Receiver to your TV.

- Connect the satellite receiver's audio/video output jacks to the INPUT2 AUDIO (R and L) and VIDEO jacks on the TV using audio/video cables. If your satellite receiver has an S-Video output, you can make the video connection by using the S-Video jacks instead.

Note: If you are using an S-Video cable, you must also use audio cables. The S-Video cable only transfers video information.

Viewing the Components

- Turn on the TV and the component(s) you want to view.
- Press the TV button on the remote control.
- Press the INPUT button on the remote control to scroll through the video inputs.
 - The VCR can be viewed on the VID1 input channel.
 - The satellite receiver can be viewed on the VID2 input channel.

Note: You can set up the TV to automatically tune to the correct input channel. This is called Autotuning. (See Chapter 3 for more information.)

Go to page 15

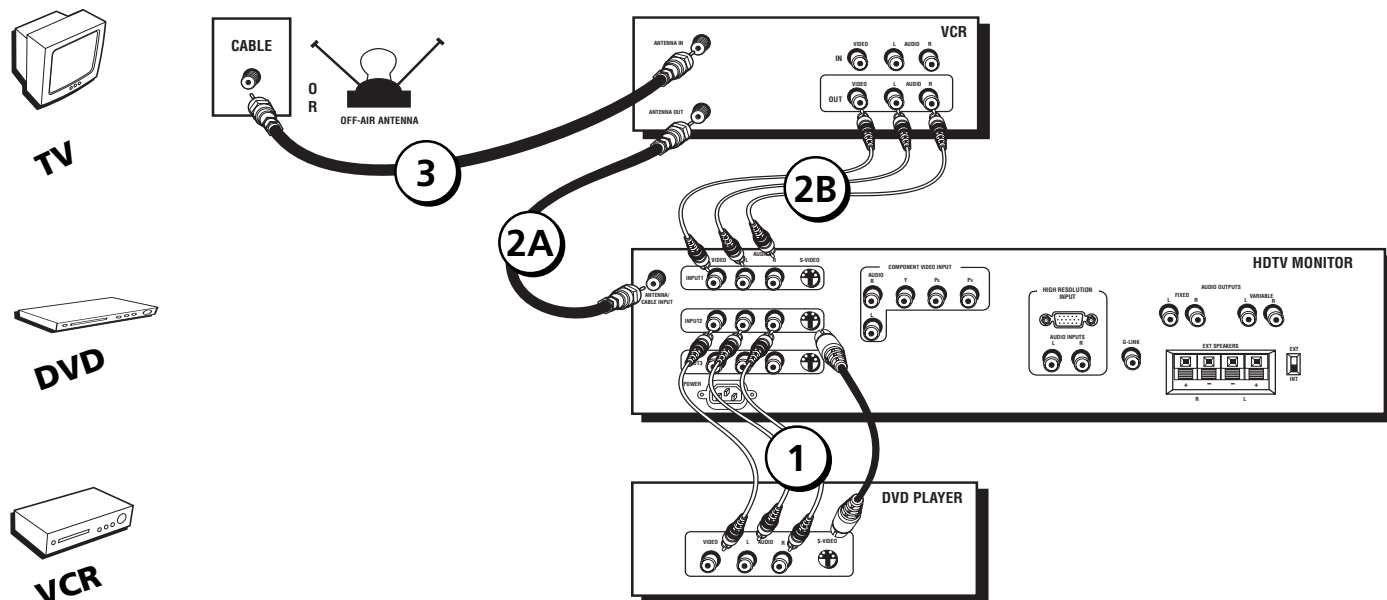

How to Connect: TV + DVD + VCR

1. Connect your DVD Player to your TV.

A. Connect the DVD player's audio/video output jacks to the INPUT2 AUDIO (R and L) and VIDEO jacks on the TV using audio/video cables. If your DVD player has an S-Video output, you can make the video connection by using the S-Video jacks instead.

Notes:

- If you are using an S-Video cable, you must also use audio cables. The S-Video cable only transfers video information.
- If your DVD player has a component video output, we recommend you use the component video input on the TV instead of the standard video or S-Video connection.

2. Connect your VCR to your TV.

A. Connect a coaxial cable to the VCR's antenna output and to the ANTENNA/CABLE INPUT jack on the TV.

B. Connect the VCR's audio/video output jacks to the INPUT1 AUDIO (R and L) and VIDEO jacks on the TV using audio/video cables.

3. Make sure cable or antenna is connected to your VCR.

A. Connect the coaxial cable carrying your television signal (off air or cable) to the antenna input on the VCR.

Viewing the Components

1. Turn on the TV and the component(s) you want to view.
2. Press the TV button on the remote control.
3. Press the INPUT button on the remote control to scroll through the video inputs.
 - The VCR can be viewed on the VID1 input channel.
 - The DVD player can be viewed on the VID3 input channel.

Note: You can set up the TV to automatically tune to the correct input channel. This is called Autotuning. (See Chapter 3 for more information.)

Go to page 15

Connections & Setup

How to Connect: A/V Receiver + Speakers

1. Connect either the FIXED or VARIABLE AUDIO OUTPUT from the TV to an A/V receiver using audio cables.

- FIXED provides fixed-level audio output from the TV. This audio output is ideal for connecting to an A/V receiver that has its own volume control.

Note: If you use the fixed audio output jacks, you may want to turn off the volume display in the Audio menu.

- VARIABLE provides variable-level audio output. Volume levels are controlled by the volume controls on the TV and TV remote control.

2. Use speaker wire to connect the TV to external speakers.

- The EXT/INT switch beside the jacks let you turn the TV's internal speakers on or off. EXT sends audio to external speakers only. INT sends audio to the TV's internal speakers only.

Note: The external speaker rating is 8 ohms with 10 watts power handling capabilities.

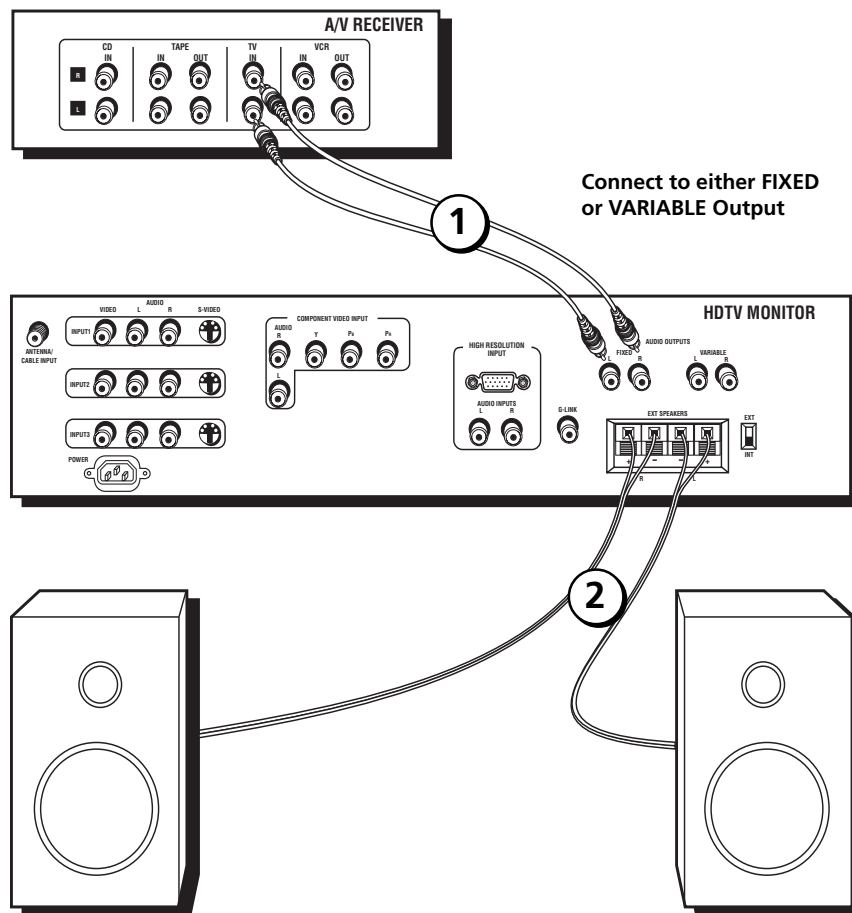

Explanation of Input Jacks and Cables

This section describes the jacks and cables you can use to make connections. There are several ways to connect components to your TV.

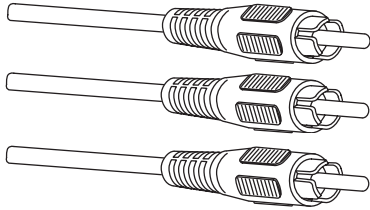

Component Video (Y•Pb•Pr) Jacks and Cables

The Y•Pb•Pr jacks allow you to connect an optional component video source, such as a DVD player. This connection provides optimum picture quality because the video is separated into three signals. To ensure maximum picture quality, use three video-grade cables for the connection.

Note: Also, remember to connect the left and right audio cables because the Y•Pb•Pr cables carry only the picture signal, not the sound.

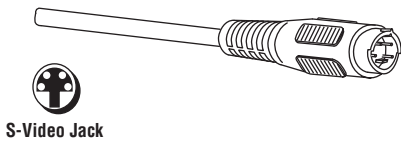
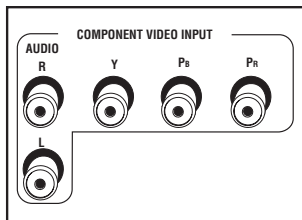

S-Video Jack

S-Video Jacks and Cables

The S-Video (separate video) jacks provide better picture quality than the regular video jacks (labeled INPUT1 VIDEO; INPUT2 VIDEO; INPUT3 VIDEO) because the color (chrominance, also called chroma) part of the signal is separated from the black and white (luminance) part of the picture.

If a component you're connecting to your TV (like a DVD) has an S-VIDEO jack, connect the DVD to the TV with an S-Video cable (not provided) for a better quality picture.

Note: Remember to connect the left and right audio cables because the S-Video cable carries only the picture signal, not the sound.

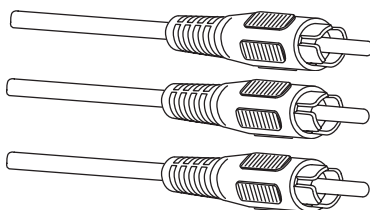

Audio/Video Jacks and Cables (RCA-type)

These jacks are used for most audio/video connections between components. The audio/video jacks are often color coded (yellow for video, red for right audio, and white for left audio). This is also called composite video.

Note: If your component has only one input for audio (mono), connect it to the left (white L/Mono) audio jack on the TV and don't connect the right audio part of the cable.



Audio/Video Jacks

Connections & Setup

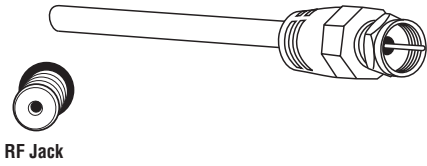

RF Jack and Coaxial Cables (F-type)

The RF jack is necessary for reception of off-air broadcasts, cable, and satellite signals.

This jack is required for antenna or cable connections. The RF jack on the TV is labeled ANTENNA/CABLE INPUT.

An RG-6 coaxial cable is required for all satellite signal distribution.

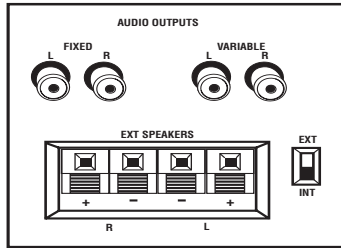

Audio Output Jacks and the External Speakers Jacks and Switch

These jacks are used to connect your TV to an audio receiver or other audio processing component. The two types of jacks you can use for audio output are fixed and variable. You can also connect external speakers directly to the TV, if you want to use the TV's audio processor.

The FIXED jacks provide fixed-level audio output from the TV. This audio output is ideal for connecting to an A/V receiver when you want to control the volume through the A/V receiver.

Note: If you use the FIXED AUDIO output jacks, you may want to turn off the volume display in the Audio menu.

The VARIABLE jacks provide variable-level audio output. Volume levels are controlled by the volume controls on the TV and remote control.

The EXT SPEAKERS jacks let you connect external left and right speakers to the TV. The EXT/INT switch beside the jacks lets you turn the TV's internal speakers on or off. EXT sends audio to external speakers only. INT sends audio to the TV's internal speakers only.

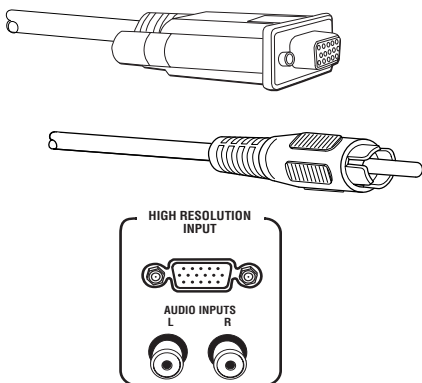

High Resolution Input Jack and Cables

This jack lets you connect your TV to an RGB or component video device (Y•Pb•Pr). How images are displayed, however, depends on other factors such as the type of device connected to the TV and the media being transmitted.

Notes:

- Remember to connect the left and right audio cables because the high resolution cable carries only the picture signal, not the sound.
- The TV automatically detects when a component is connected to the HIGH RESOLUTION INPUT jack. To connect a component video device to this jack, you need to use the supplied RGB-component video adapter cable. The TV automatically detects and displays the component video signal.

Why You Should Connect the G-LINK Cable

The G-LINK cable enables the GUIDE Plus+ system (the on-screen interactive program guide) to work with your VCR and/or cable box.

Cable Box – If your TV is connected to a cable box, you must connect the G-LINK cable to receive TV program listings for your area and to tune directly to a channel when the program guide is on your TV screen.

VCR – If your TV is connected to a VCR and you don't connect the G-LINK cable, one-touch VCR recording won't work. The other features of the guide will work properly, however.

How to Find the Remote Sensor

You have to place the G-LINK wands in front of the remote sensor on the VCR and/or cable box. Some cable boxes and VCRs have the remote sensor labeled on the unit. If the remote sensor isn't labeled on your VCR and/or cable box, you need to use the remote control that came with the VCR and/or cable box to locate the sensor.

1. Turn off the VCR and/or cable box.
2. Hold the remote control (**not** the one that came with your TV, but the one that came with the cable box and/or VCR to which you're attaching the G-LINK cable) so that it is touching the front of the component.
3. Slowly move the remote control across the front of the component (VCR or cable box) while you press the power button on and off. You must press and release the power button each time you move the remote (holding down the button won't work).

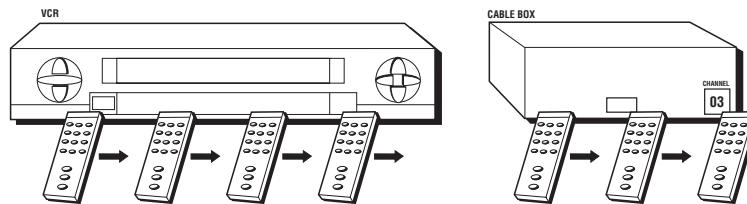

4. When the component turns on, you've located the VCR's or cable box's remote sensor.

Placing the G-LINK Wands

Place the G-LINK wands in front of the remote sensor on your VCR and/or cable box approximately one inch away from the remote sensor (see instructions below).

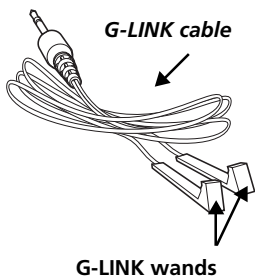
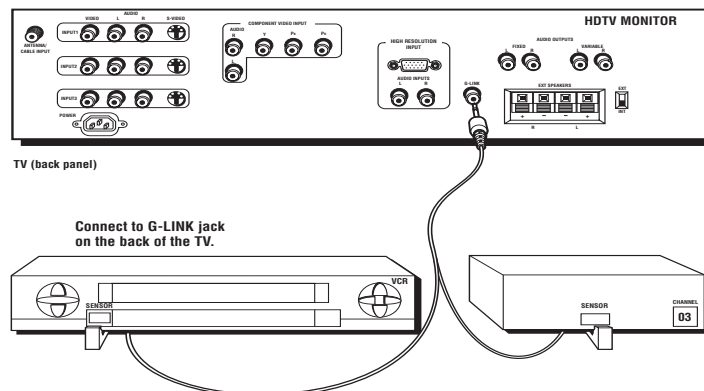

If there is a demo pin in the G-LINK jack on the back of the TV, you must remove it before you connect the G-LINK cable. If there is no demo pin, just insert the G-LINK cable into the G-LINK jack.



Tip

If you don't have both a cable box and a VCR connected to your TV, just coil the cable of the extra G-LINK wand with a twist tie and leave it behind the TV.

The Front of Your TV

Front Inputs

The TV has front inputs for convenience: one set of audio/video inputs, and a headphone jack. Look for a hinged door and open the cover. Please note the illustration below shows a typical front input layout.

Notes:

- When you plug in headphones, the TV's internal and external speakers are automatically turned off.
- When connecting a device that uses a monaural cable, such as some camcorders, use the Left (mono) input jack to get sound from both speakers.

Front Panel

If you cannot locate your remote, you can use the front panel of your TV to operate many of the TV's features.

MENU/OK Brings up the Main menu. In the menu system, it selects highlighted items.

CH v Scans down through the current channel list. In the menu system, it points down to items and adjusts menu controls.

CH ^ Scans up through the channel list. In the menu system, it points up to items and adjusts menu controls.

VOL - Decreases the volume. In the menu system, it points left to items and adjusts menu controls.

VOL + Increases the volume. In the menu system, it points right to items and adjusts menu controls.

POWER Turns the TV on and off.

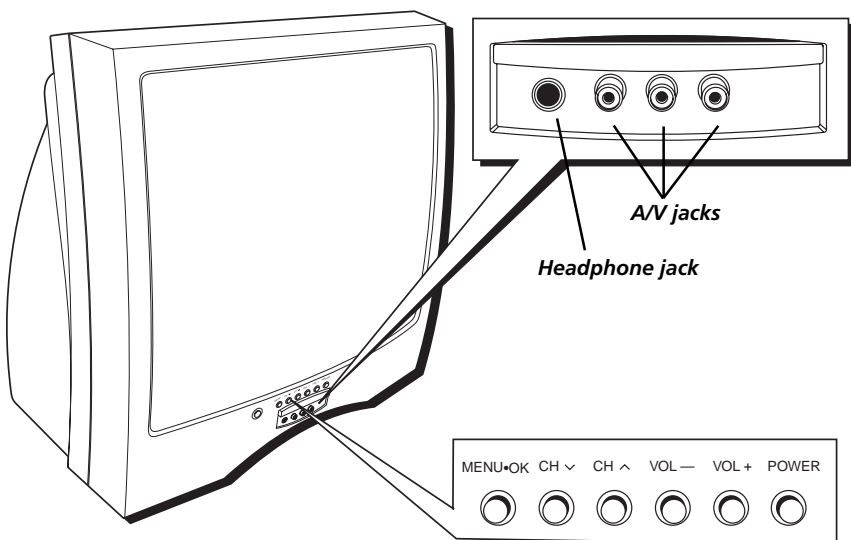

The front panel illustration shows a typical front panel layout. The exact look may be different from the one on the front of your TV.

If you use the Front Panel Block feature, the front panel no longer provides access to the menus. The Front Panel Block feature disables all front panel buttons. For more information, see Chapter 3.

Plug in the TV

Plug the flat end of the cable into the POWER jack on the back of the TV. Then plug the end of the power cord into an appropriate wall outlet. Be sure to insert the plug completely.

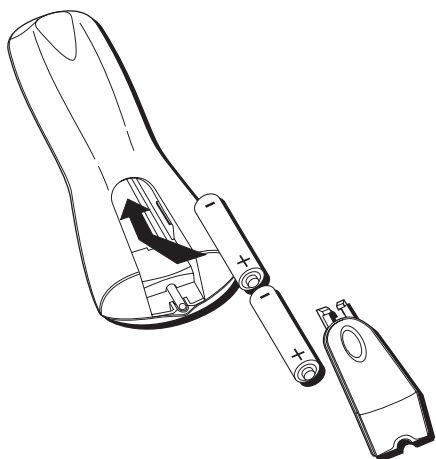

Put batteries in the remote

- Remove the battery compartment cover from the back of the remote by pushing down on and sliding off the cover.
- Insert 2 “AA” fresh batteries. Make sure the polarities (+ and -) are aligned correctly.
- Replace the cover.

How to Use the Remote Control to Complete the Interactive Setup

The technical term is “Navigation” – how you move through the on-screen menus. The theory is the same throughout the menu screens: highlight your choice and select it.

To highlight a menu item, press the arrow buttons on the remote to highlight one of the items listed on the screen. Use the up or down arrow button to move up or down. Use the right or left arrow button to move right or left.

To select the item that you’ve highlighted, press OK.

Note: *Highlighted means that the menu item stands out from other menu items on the list (appears darker, brighter, or a different color).*

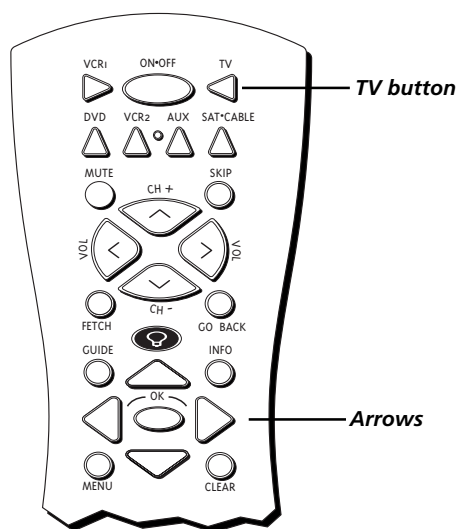

Turn on the TV

Press TV on the remote, or press POWER on the TV’s front panel.

Note: *Pressing the TV button not only turns on the TV, but puts the remote into TV mode. “TV mode” means that the buttons on the remote control operate the TV’s functions.*

Tip

To access the setup menus manually, press **MENU** and choose **SETUP**.

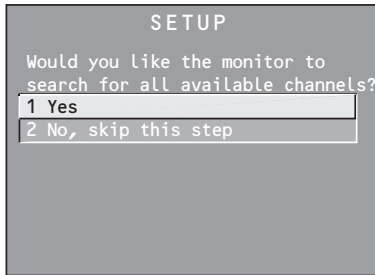

Complete the Interactive Setup

The menu system in your TV allows the TV's features to work properly. In this book, we call it the "interactive setup" because the TV asks you questions, you answer, and the TV makes the appropriate adjustments. The first time you turn on your TV, the setup screens appear automatically.

Set the Menu Language

The first part of the *SETUP* menu asks you to select your preferred language for the menu system.

1. Highlight your preferred language for the menu system using the arrow buttons.
2. Press OK to select that language.

Complete Auto Channel Search

The next part of the *SETUP* asks you if you want the TV to search for all channels viewable through your antenna or cable TV system. This is sometimes called "auto programming."

1. Highlight *Yes* and press OK to tell the TV to begin searching for channels. A progress report appears on the screen.
2. When the screen on the TV tells you the search is complete, press OK (the first GUIDE Plus+ system setup screen appears).

Note: If you skip Auto Channel Search now, you can access it later through the Channel menu. See Chapter 4 for more details.

The GUIDE Plus+ System Setup

Tip

If you move to a new zip or postal code, or if any of your information changes and you need to access the setup screens from the TV's main menu—press **MENU**, choose **GUIDE Plus+ Menu**, and choose **GUIDE Plus+ Setup**, then choose **Setup**.

Important: If you have a VCR or cable box connected to the TV, you need to connect the G-LINK cable to use the GUIDE Plus+ system. Go to page 15.

The GUIDE Plus+ system is an on-screen interactive program guide that lists what shows are on TV in your area. In order to receive program listings, you need to complete the following steps.

Step 1: Begin Setup

Use the arrow buttons to highlight *Setup* and press OK.

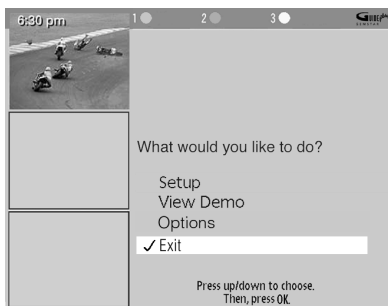

Step 2: Identifying Your TV's Location

1. If your country is highlighted, press OK on the remote control.

If your country isn't highlighted, press the up or down arrow button on the remote control to highlight your country and press OK.



2. Use the number buttons on your remote to enter your zip code or postal code.

Press OK when you're finished.

Note: If your postal code contains letters, press the up and down arrow buttons on your remote to enter letters, and press the right arrow button to go to the next space. The left arrow button also moves the highlight to the left.



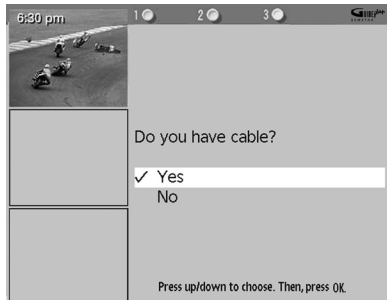

Step 3: Configuring for Cable

The next series of screens asks you about your cable setup. To supply your TV with the correct TV program listings, the GUIDE Plus+ system needs to know if your TV is connected to cable.

1. If your TV is connected to cable, highlight *Yes* and press OK.

If your TV isn't connected to cable, highlight *No* and press OK.

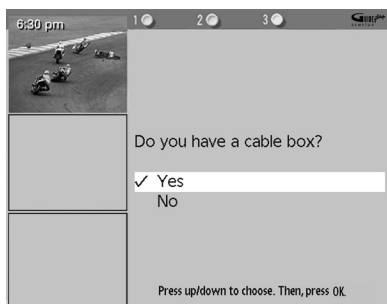

2. If you have a cable box connected to this TV, highlight *Yes* and press OK on your remote control.

Note: *The next series of screens is very important because the GUIDE Plus+ system must find the correct cable box information in order to receive the correct TV program listings.*

If you don't have a cable box connected to this TV, highlight *No* and press OK. Then go to page 22.

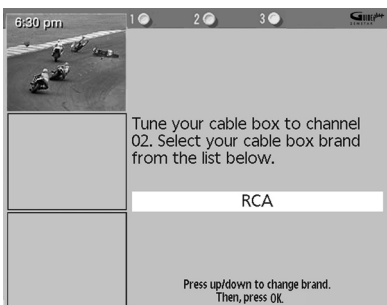

3. Use the arrow buttons to highlight your brand of cable box, and press OK.

If your brand isn't listed, highlight *Not Listed* and press OK.

4. Make sure your cable box is on.
5. Tune the cable box to channel 02 (use the remote control that came with your cable box, or press the channel buttons on the cable box). Press OK (the GUIDE Plus+ system starts testing codes).

Important: *When code testing is in progress, don't touch your TV, VCR, cable box, or any of the remote controls for these products.*

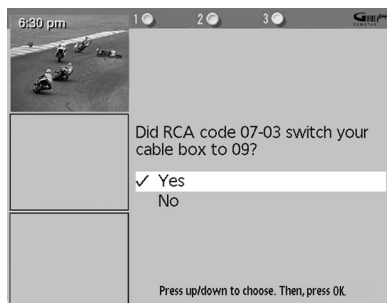

6. Look at your cable box. If it is still on and changed to channel 09, the test was successful. Highlight *Yes*, and press OK.

If the cable box did not change to channel 9, highlight *No*. If you select *No*, the system will try another code.

If the GUIDE Plus+ system cannot recognize your cable box after several tries, a screen stating “Cable Box (VCR) test failed...Please consult your manual and try again” appears. You have a choice to either *Try Again* or *Skip Cable Box Setup*. If you get this message, you should also:

- Double check the brand of your cable box, and try entering it again.
- Check to make sure the G-LINK cable wand is positioned correctly.

If you choose to skip the cable box or VCR setup some features of the guide may not be available until you successfully complete this procedure.

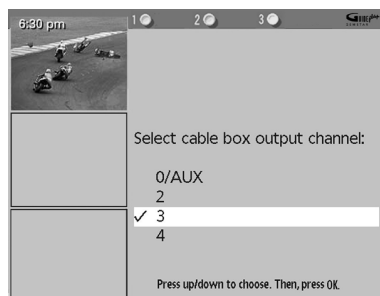

7. Highlight the channel to which you have to tune your TV in order to see cable programming, and press OK (a screen appears reminding you to connect your G-LINK cable to your TV and cable box).

Notes:

- *Channel 03 is the most common.*
- *Choose Video1/AUX if your cable box is connected to your TV with audio/video cables instead of a coaxial cable. Go to page 13 for pictures of these cables.*

Tips

If you're not sure which channel is the cable box's output channel, consult the owner's manual that came with your cable box or contact your cable company.

Leave your cable box turned ON to receive program information.

Leave your VCR turned OFF to record programs.

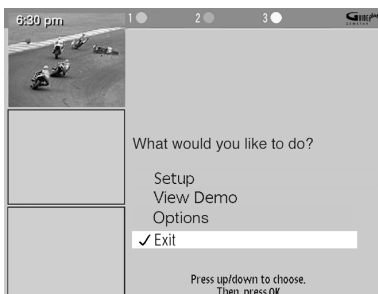
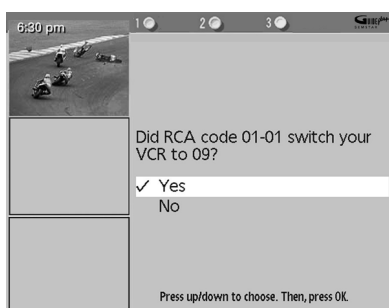
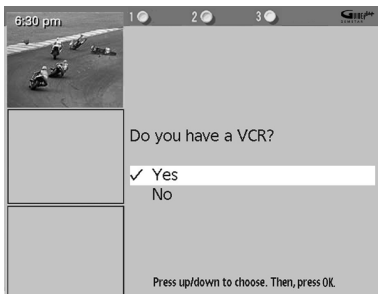

Step 4: Configuring for a VCR

1. If your TV is connected to a VCR, press OK.
If it is not, highlight *No* and press OK. (Answering *No* automatically skips to the end of GUIDE Plus+ setup.)
2. Use the up and down arrow buttons to highlight the brand of your VCR that is connected to the TV and press OK.
If your brand isn't listed, highlight *Not Listed* and press OK.
3. Tune your VCR to channel 02. Next, turn OFF your VCR. When you complete these steps, press OK to begin testing.

Important Note: When code testing is in progress, don't touch your TV, VCR, or any of the remote controls for these products.

4. Look at the front display of your VCR. If your VCR turned on automatically and changed to channel 09, the test was successful. Highlight *Yes* and press OK.

If your VCR did not change to channel 9, highlight *No*. If you select *No*, the system will try another code.

If the GUIDE Plus+ system cannot recognize your VCR after several tries, a screen stating "Cable Box (VCR) test failed...Please consult your manual and try again" appears. You have a choice to either *Try Again* or *Skip VCR Setup*. If you get this message, you should also:

- Double check the brand of your VCR, and try entering it again.
- Check to make sure the G-LINK cable wand is positioned correctly.

If you choose to skip the cable box or VCR setup some features of the guide may not be available until you successfully complete this procedure.

You can choose to view a demo of the GUIDE Plus+ features, which may take a few minutes to load. If you don't want to see the demo right now, highlight *Exit* and press OK to watch TV.

What to Expect

The next time you turn on your TV, the GUIDE Plus+ system will appear on the screen. The following examples explain what you might see:

- If all of the program information has been sent to your TV, the GUIDE Plus+ system appears with all of your TV program listings.
- If the program information hasn't been sent to your TV yet, an outline of the GUIDE (without TV program listings) will appear on the screen. Program information is usually sent to your TV at night.
- If more than one cable company services your area, you may be prompted with a Channel Mapping screen after the first GUIDE Plus+ system download. You will need to identify your cable company by selecting the correct channel numbers for the stations in question.

Features of the GUIDE Plus+ system are explained in Chapter 3.

To clear the guide from your screen, press CLEAR or GUIDE on the remote control.

Next Steps

Now that you've finished the Interactive Setup, you're ready to watch TV. This might be a good time to program your remote control. The remote control that came with this TV can be programmed to operate other components. Go to the next chapter to find out how to program your remote.

This page left intentionally blank.

Using the Remote Control

Chapter Overview:

- The Buttons on the Remote Control
- Programming the Remote to Operate Other Components
- How To Use the Remote After You've Programmed It
- Code List

Changing Entertainment. Again.



Using the Remote Control

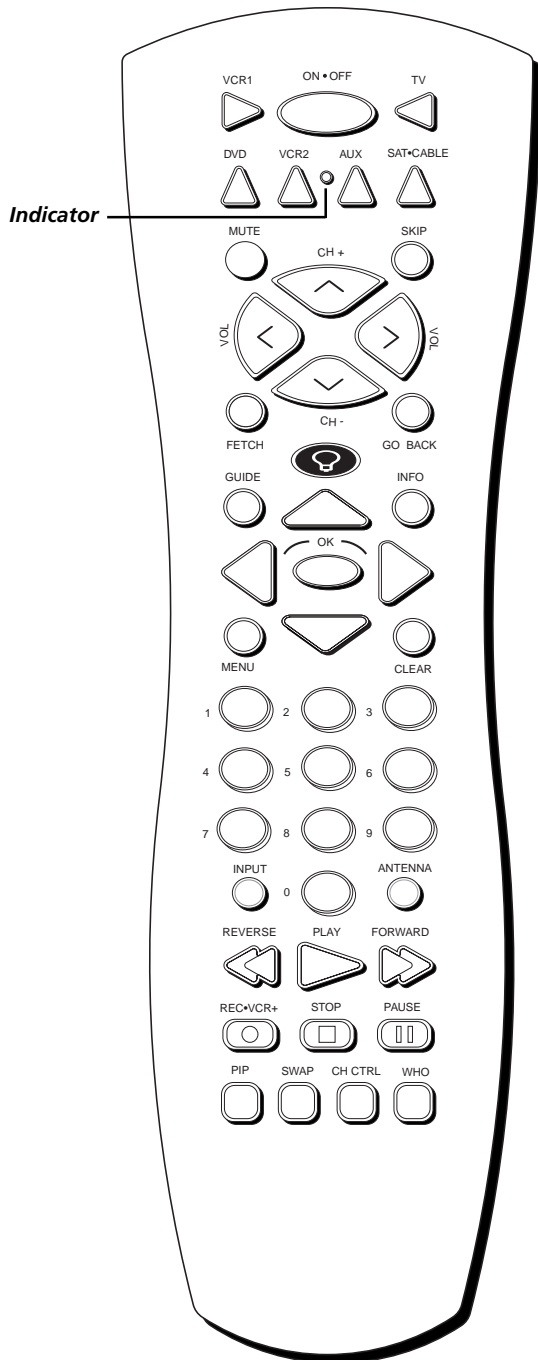

Note: The VCR1, DVD, VCR2, and SAT•CABLE buttons also turn on most RCA, GE, and PROSCAN products.

The Buttons on the Remote Control

(0-9) Number Buttons Enter channel numbers and time settings directly through the remote control. They are also used in the GUIDE Plus+ system and in the TV menu to make selections.

To enter a one-digit channel, enter a zero first. To enter a two-digit channel, press the two digits. To enter a three-digit channel, press and hold the “1” button until “1” and two dashes (– –) appear, then add the second two digits. Example: to tune to channel 123, press and hold 1 until “1– –” appears, release the 1 button and then press 2 and 3.

ANTENNA Functions as TV/VCR button in VCR mode and TV/receiver button in satellite mode for most brands.

Move (Arrows) Used to point to different items in the GUIDE Plus+ system and TV menu and to adjust the menu controls. Also moves the PIP window when no menus are on the screen.

AUX Puts the remote in AUX mode. Can also be programmed to operate most brands of an additional remote-controllable component.

Backlight Lights up some of the buttons in the dark.

CH + or CH - Scans up or down through the current channel list. Press once to change the channel up or down; press and hold to continue changing channels. In DVD mode, skips chapters for some brands. In the Guide Plus+ system, scrolls a page of info at a time.

CH CTRL When using PIP, selects the picture window, (that is, the main or PIP window) to be changed by the CH ^ (channel up) or CH v (channel down) buttons.

CLEAR Removes any menu or display from the screen and returns you to normal viewing.

DVD Puts the remote in DVD mode and, if Autotuning is enabled, will turn on the TV and tune to the correct input channel.

FETCH Turns 16:9 mode on or off in the TV mode.

GO BACK Returns you to the previous channel or previous screen in the menu system.

GUIDE Brings up and exits the GUIDE Plus+ system. In SAT•CABLE mode, brings up available on-screen guides for some brands.

INDICATOR Indicates the programming mode when programming the remote to control components.

INFO Brings up channel information; press again to clear the screen. In the GUIDE Plus+ system, brings up more program information.

INPUT In TV mode, press to toggle through the available input sources (VID1, VID2, VID3, FRONT, HiRes, CMPNT, last channel).

MENU Brings up the Main menu and selects highlighted items. In VCR mode, it functions as a PROGRAM button for most brands.

Using the Remote Control

Tip

To turn off all the RCA, GE, and PROSCAN components that are connected to the TV, press ON•OFF twice within two seconds.

This feature only works with most RCA, GE, and PROSCAN products.

MUTE Reduces the TV's volume to its minimum level. Press again to restore the volume.

OK When in the menu system, selects highlighted items.

ON•OFF When in TV mode, turns the TV on and off. If in another device mode (VCR, DVD, SAT•CABLE, etc.) and programmed, will turn the device on and off.

PIP Brings up the small picture-in-picture window. Press again to remove the PIP window. (See Chapter 3 for more information about using PIP.)

REVERSE, PLAY, FORWARD, REC•VCR+, STOP, PAUSE If programmed, provides transport control for some remote-controllable VCRs, DVD players, laserdisc players, tape decks, and CD players. Pressing REC•VCR+ when using the GUIDE Plus+ System sets the VCR to record a program.

SAT•CABLE Puts the remote in SAT•CABLE mode and, if Autotuning is enabled, will turn on the TV and tune to the correct input channel.

SKIP Press once before changing channels and the TV will wait 30 seconds before returning you to the original channel. Press repeatedly to add more time. Also, activates Search function for some GE, RCA, or PROSCAN VCRs.

SWAP When using PIP, swaps the main picture with the PIP window.

TV Turns on the TV and puts the remote in TV mode. Also displays channel information.

VCR1 Puts the remote in VCR1 mode and, if Autotuning is enabled, will turn on the TV and tune to the correct input channel.

VCR2 Puts the remote in VCR2 mode and, if Autotuning is enabled, will turn on the TV and tune to the correct input channel.

VOL – or VOL + Decreases or increases the TV's volume.

WHO In SAT mode, press to select available channel lists "profiles" (RCA, GE, and PROSCAN satellite or HD receivers only). This button does not operate in the TV mode.

Using the INPUT Button

Use the INPUT button to scroll through the available input channels and view components you have connected to the TV.

1. Press TV to place the remote in TV mode. Make sure the component you want to view is turned ON.
2. Press INPUT to tune to an available input channel.
3. To return to the channel you were previously watching, press the INPUT button until you see the channel in the upper right corner.

Using the Remote Control

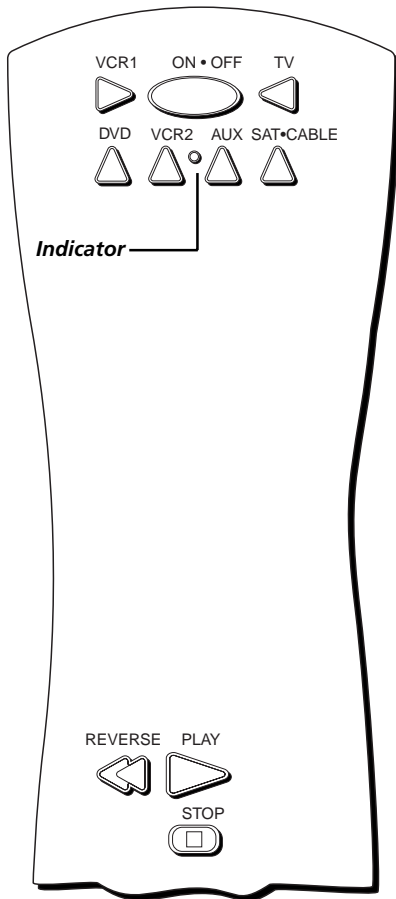

You'll use these buttons when you program the remote.

Important: The remote may not be compatible with all models of all brands of components. It also may not operate all functions of the remote that came with your component.

Tip

To stop the automatic code search without programming any components, press and hold CLEAR until the indicator on the remote turns off.

Programming the Remote to Operate Other Components

The universal remote can be programmed to operate most brands of remote controllable components. The remote is already programmed to operate most RCA, GE, and PROSCAN components.

Also, the AUX button can be programmed to operate most brands of an additional remote-controllable component.

Note: The TV button can't be programmed on this remote.

Find Out If You Need to Program the Remote

To determine whether the universal remote needs to be programmed for your component, turn the component ON. For example, to program the remote for a VCR, turn on the VCR. Point the remote at the VCR, and press the VCR1 button. Then press ON • OFF or CH + (channel up) or CH - (channel down) to see if the VCR responds to the remote commands. If the component does not respond, the remote needs to be programmed.

Programming the Remote

There are two ways to program the remote control:

- automatic code search
- direct entry

Using Automatic Code Search

The following instructions can be used to program the remote to operate each of your components. If you want to stop the automatic code search without programming any of your components, press CLEAR until the indicator on the remote turns off.

1. Turn on the component you want to operate (VCR, DVD player, etc.)
2. Press and hold the component button you want to program (VCR1, DVD, etc.). While holding the component button, press and hold ON • OFF until the indicator on the remote turns on, then release both buttons.
3. Point the remote at the component. Press and release PLAY, then wait 5 seconds or until the indicator on the remote stops flashing.

Using the Remote Control

At this point the remote is searching for the correct code to program. If, after 5 seconds, the component you want to operate does not turn off, press PLAY again to tell the remote to search the next set of codes.

Continue pressing PLAY until the component turns off or you have searched through all of the codes. There are 20 total sets of codes. If the component does not turn off after pressing PLAY 20 times, then the remote can't be programmed to operate that component.

If the component you want to control *does* turn off:

1. Press and release REVERSE, then wait 2 seconds. Repeat this step until the device turns back ON.
2. To finish, press and hold STOP until the indicator on the remote turns off.

Important

You must continue pressing the component button while you enter the code.

Let's say you have a Zenith VCR. To program the universal remote to operate the VCR, you would:

Press and hold the VCR1 button while you enter the first code listed for Zenith in the VCR Codes column.

Release the VCR1 button. Press ON•OFF to see if the VCR responds. If it doesn't, follow the same steps, but enter the second code for Zenith VCRs instead of the first.

Note

Some of the remote's buttons might operate differently for other components, especially when you're using another component's menu system.

Using Direct Entry

1. Turn on the component to be programmed.
2. Look up the brand and code number(s) for the component on the code list in this section.
3. Point the remote at the component.
4. Press and hold the component button you want to program on the remote.
5. Enter the 4-digit code from the remote control code list on the following pages. If the indicator flashes, you have either entered an invalid code or the button isn't programmable.
6. Release the component button, and then press ON•OFF to see if the component responds to the command. If it doesn't, try pressing the component button and then ON•OFF again.
 - If you get no response, repeat these steps using the next code listed for your brand, until the component responds to the remote commands.
 - If you try all the codes for your component brand and none work, try the automatic code search method. If automatic code search doesn't find the code, the remote is not compatible with your component.

Using the Remote Control

How to Use the Remote After You've Programmed It

Because this universal remote can control several different components (TV, DVD, VCR, satellite receiver, etc.) it uses operational modes triggered by the component buttons. For example, if you want the remote to control the TV, you would press the TV button to put the remote into TV mode before you could control the TV.

1. Press the appropriate component button (DVD, TV, VCR1, VCR2, SAT•CABLE, AUX) to set the remote to control the component.
2. Press ON•OFF to turn the component ON or OFF.
3. Use the remote buttons that apply to that component.

Notes:

- *The remote may not be compatible with all brands and models of components. It also may not operate all functions of the remote that came with your component.*
- *If you keep pressing buttons and nothing happens, the remote is probably in the wrong mode. You must press the component button that matches the component you want to operate (i.e., if you want to operate the VCR, press VCR1 on the remote control to put the remote in VCR mode.)*

Using the Remote Control

VCR Codes

Programmable for VCR1, VCR2, and AUX buttons.

Admiral	2132
Adventura	2026
Aiko	2027
Aiwa	2026
Akai	2003, 2004, 2005, 2007, 2008, 2111, 2112, 2113
American High	2021
Asha	2013
Audio Dynamics	2009, 2010
Audiovox	2014
Bell & Howell	2011
Beaumarck	2013
Broksonic	2012, 2025
Calix	2014
Candle	2013, 2014, 2015, 2016, 2017, 2018, 2019
Canon	2021, 2022, 2114
Capehart	2020, 2110
Carver	2062
CCE	2027, 2061
Citizen	2013, 2014, 2015, 2016, 2017, 2018, 2019, 2027
Colortyme	2009
Colt	2061
Craig	2013, 2014, 2023, 2061
Curtis-Mathes	2000, 2009, 2013, 2016, 2018, 2021, 2022, 2024, 2115, 2131
Cybermex	2013
Daewoo	2015, 2017, 2019, 2025, 2026, 2027, 2028, 2110
Daytron	2110
DBX	2009, 2010
Dimensia	2000, 2131
Dynatech	2026
Electrohome	2014, 2029
Electroponic	2014
Emerson	2012, 2014, 2015, 2021, 2024, 2025, 2026, 2029, 2030, 2031, 2032, 2033, 2034, 2035, 2036, 2037, 2038, 2039, 2040, 2041, 2042, 2044, 2045, 2046, 2047, 2065, 2113, 2116, 2117, 2130
Fisher	2011, 2023, 2048, 2049, 2050, 2051, 2052, 2118
Fuji	2021, 2119
Funai	2026
Garrard	2026
GE	2000, 2001, 2013, 2021, 2022, 2053, 2115, 2120, 2131
Goldstar	2009, 2014, 2018, 2054, 2131
Gradiente	2026
Harley Davidson	2026
Harman Kardon	2009
Harwood	2061
Headquarter	2011
Hitachi	2055, 2056, 2057, 2107, 2111, 2120, 2122
Hi-Q	2023
Instant Replay	2021
JCL	2021
JC Penney	2009, 2010, 2011, 2013, 2014, 2021, 2022, 2055, 2056, 2058, 2059, 2060, 2107, 2118
Jensen	2055, 2056, 2111
JVC	2009, 2010, 2011, 2018, 2111, 2123
Kenwood	2009, 2010, 2011, 2016, 2018, 2111, 2123
KLH	2061
Kodak	2014, 2021
Lloyd	2026
Logik	2061
LXI	2014

Magnavox	2021, 2022, 2062, 2063, 2104, 2105, 2108, 2124
Magnin	2013
Marantz	2009, 2010, 2011, 2016, 2018, 2021, 2062, 2064
Marta	2014
Masushita	2021
Mei	2021
Memorex	2011, 2013, 2014, 2021, 2023, 2026, 2104, 2132
MGA	2029, 2065, 2113
MGN Technology	2013
Midland	2053
Minolta	2055, 2056, 2107
Mitsubishi	2029, 2055, 2056, 2065, 2066, 2067, 2068, 2068, 2070, 2071, 2072, 2073, 2074, 2106, 2113, 2123
Montgomery Ward	2075, 2132
Motorola	2021, 2132
MTC	2013, 2126
Multitech	2013, 2016, 2026, 2053, 2061
NEC	2009, 2010, 2011, 2016, 2018, 2064, 2076, 2078, 2079, 2111, 2123
Nikko	2014
Noblex	2013
Olympus	2021
Optimus	2014, 2132
Optonica	2096
Panasonic	2021, 2022, 2109, 2125, 2126, 2127
Pentax	2016, 2055, 2056, 2107, 2120
Pentax Research	2018
Philco	2021, 2022, 2062, 2063
Philips	2021, 2062, 2096, 2124
Pilot	2014
Pioneer	2010, 2055, 2080, 2081, 2123
Portland	2016, 2017, 2019, 2110
PROSCAN	2000, 2001, 2131
Protec	2061
Pulsar	2104
Quarter	2011
Quartz	2011
Quasar	2021, 2022, 2125
RCA	2000, 2001, 2003, 2013, 2021, 2055, 2056, 2082, 2083, 2084, 2085, 2086, 2087, 2088, 2089, 2090, 2091, 2107, 2115, 2120, 2125, 2131, 2133
Radioshack/Realistic	2011, 2013, 2014, 2021, 2022, 2023, 2026, 2029, 2049, 2050, 2096, 2132
Radix	2014
Randex	2014
Ricoh	2128
Runco	2104
Samsung	2005, 2013, 2015, 2033, 2053, 2112
Sanky	2104, 2132
Sansui	2010, 2092, 2111, 2123
Sanyo	2011, 2013, 2023
Scott	2012, 2015, 2025, 2032, 2038, 2065, 2093, 2116
Sears	2011, 2014, 2021, 2023, 2048, 2049, 2050, 2051, 2055, 2056, 2107, 2118
Sharp	2017, 2029, 2094, 2095, 2096, 2097, 2131
Shintom	2004, 2056, 2061, 2098
Shogun	2013
Signature	2131
Singer	2021, 2061, 2128
Sony	2004, 2098, 2099, 2119
STS	2021, 2107
Sylvania	2021, 2022, 2026, 2062, 2063, 2065, 2124
Symphonic	2026
Tandy	2011
Tashiko	2014
Tatung	2111
TEAC	2026, 2085, 2111
Technics	2021, 2109
Teknika	2014, 2021, 2026, 2100, 2129
TMK	2013, 2024, 2047

Toshiba	2015, 2049, 2051, 2055, 2065, 2093, 2116
Totevision	2013, 2014
Unitech	2013
Vector Research	2009, 2010, 2015, 2016
Victor	2010
Video Concepts	2009, 2010, 2015, 2016, 2113
Videosonic	2013
Wards	2013, 2014, 2015, 2021, 2023, 2026, 2029, 2055, 2056, 2061, 2096, 2101, 2102, 2103, 2107, 2116, 2132
XR-1000	2021, 2026, 2061
Yamaha	2009, 2010, 2011, 2018, 2111
Zenith	2004, 2098, 2104, 2119, 2128

Cable Box Codes

Programmable for SAT•CABLE and AUX buttons.

ABC	5002, 5003, 5004, 5005, 5006, 5053
Antronix	5008, 5009
Archer	5008, 5009, 5010
Cabletenna	5008
Cableview	5008
Colour Voice	5012, 5013
Comtronics	5014
Contec	5016
Eastern	5017
Garrard	5011
GC Electronics	5009
GE	5000, 5001
Gemini	5018, 5019
General Instrument	5003
Hamlin	5020, 5021, 5022, 5028, 5035, 5045
Hitachi	5003
Jerrold	5003, 5018, 5023, 5024, 5046, 5053
Magnavox	5025
Memorex	5026
Movie Time	5027
NEC	5005
NSC	5027
Oak	5016, 5029
Panasonic	5048, 5052
Philips	5011, 5012, 5013, 5015, 5019, 5025, 5030, 5031, 5032
Pioneer	5033, 5034
PROSCAN	5000, 5001
RCA	5007, 5047, 5049, 5052
Realistic	5009
Regal	5022, 5035
Regency	5017
Rembrandt	5003
Samsung	5034
Scientific Atlanta	5006, 5036, 5037, 5038
Signal	5018
Signature	5003
Sprucer	5052
Standard Components	5039, 5044
Starcom	5018, 5053
Stargate	5018
Starquest	5018
Tandy	5040
Televue	5014
Tocom	5004, 5023
Tusa	5018
TV86	5027
Unika	5008, 5009
United Cable	5053
Universal	5008, 5009, 5010
Viewstar	5025, 5027
Zenith	5050, 5051

Using the Remote Control

Satellite Receiver Codes

Programmable for SAT•CABLE and AUX buttons.

Alphastar	5079
Chapparral	5056, 5057
Dishnet	5078
Drake	5058, 5059
Echostar	5089
GE	5000, 5001
General Instruments	5060, 5061, 5062
Hitachi	5083, 5084
Hughes	5077, 5090
JVC	5082
Panasonic	5075
Philips	5085
Primestar	5076
PROSCAN	5000, 5001
RCA	5000, 5001, 5071, 5080, 5081
Realistic	5063
Sony	5072
STS1	5064
STS2	5065
STS3	5066
STS4	5067
Toshiba	5068, 5073
Uniden	5086

DVD codes

Programmable for DVD and AUX buttons.

Aiwa	3009
GE	3000
Hitachi	3008
JVC	3002, 3010
Konka	3011, 3012
Magnavox	3003
Mitsubishi	3004
Panasonic	3013
Philips	3003, 3019, 3021, 3022
Pioneer	3005
PROSCAN	3000
RCA	3000, 3001
Sanyo	3014
Shinco	3001
Sony	3006, 3015, 3016
Toshiba	3007, 3017, 3020
Zenith	3018

Audio Codes

Programmable for the AUX button only.

RCA and Dimensia

AM/FM	4003, 4270
AUX	4004
Phono	4005
Tape	4006
CD	4007, 4190, 4211

Receivers

Aiwa	4261, 4262, 4263, 4264,
.....	4265, 4266, 4267, 4277
Denon	4283
Harman Kardon	4276

JVC	4268
JVL	4276
Kenwood	4269
Onkyo	4278
Optimus	4284
Panasonic	4279, 4280
Pioneer	4275
RCA	4270
Sherwood	4282
Sony	4271, 4272, 4281
Technics	4279, 4280
Wards	4275
Yamaha	4274, 4275

CD Players

ADC	4200, 4201, 4220
Aiwa	4175, 4203
Akai	4205
Denon	4208
Dynatech	4177
Emerson	4178
Fisher	4179, 4212, 4213
GE	4216
Hitachi	4180
JVC	4181, 4221
Kenwood	4183, 4222, 4224
Luxman	4225
Marantz	4185, 4226
Mitsubishi	4229, 4230
MCS	4228
Nakamichi	4232, 4233
NEC	4184
Onkyo	4186, 4234, 4235
Optimus	4237, 4238, 4239
Panasonic	4188
Pioneer	4189, 4240
RCA	4190, 4211
Sanyo	4250
Sears	4207
Sherwood	4243
Sony	4195, 4209, 4244
Teac	4245, 4246, 4247
Technics	4197
Toshiba	4231
Yamaha	4198, 4199, 4268

Using the TV's Features

Chapter Overview:

- All About the GUIDE Plus+ System
- The Channel Banner
- Autotuning
- Parental Controls and V-Chip
- PIP (Picture-In-Picture) Operation

Changing Entertainment. Again.



Using the TV's Features

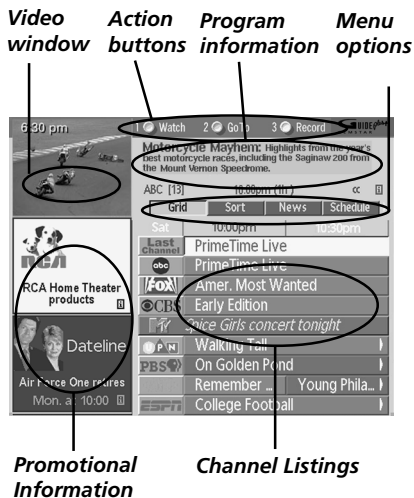

About the GUIDE Plus+ System

The GUIDE Plus+ system is an interactive on-screen program guide that lists TV schedules for your area and allows your TV direct control of a cable box and/or VCR. You must first set up the GUIDE Plus+ menu system in order to view this on-screen program guide (see Chapter 1 for details). Press GUIDE to bring up the GUIDE Plus+ system.

There are six sections of the GUIDE Plus+ system:

- A row of Action buttons at the top of the screen (1, 2 and 3)
- Video window
- Program information
- A row of menu options (Grid, Sort, News, Schedule, Messages, Editor, Setup)
- Channel listings
- Promotional information

Note: The GUIDE Plus+ system screens illustrated in this book are representations of what you are likely to see. Not all channels, programs, and GUIDE Plus+ information depicted will be available in your area.

New features and options can be downloaded to the GUIDE Plus+ system, so these too are subject to change.

Downloading Data

Important: If you have a VCR or cable box connected to the TV, you need to connect the G-LINK cable to use the GUIDE Plus+ system. Go to page 15.

The GUIDE Plus+ system is not available until it completes its first download of program listings. When the power is turned off, the TV locates a "host channel" that carries GUIDE Plus+ system data containing program schedule and channel lineup information. A channel lineup is the list of stations and their respective channels.

To ensure that your first download of data is complete, you should leave your TV off overnight. Downloads occur several times a day. The TV must be turned off for GUIDE Plus+ system data to download.

If the TV loses power or is unplugged, GUIDE Plus+ system program listings may be lost. When power is restored, make sure the setup information is still correct. The GUIDE Plus+ system will receive updated program information during the next scheduled download.

Tips

The GUIDE Plus+ system automatically comes up when you use the TV button on the remote to turn on the TV. You can turn off this feature by selecting Setup from the GUIDE Plus+ Menu, selecting Options, then setting Auto Display to Off.

Also, since the program information provided by the GUIDE Plus+ system is based on your locale, you will need to run Setup again if you move to a different zip or postal code.

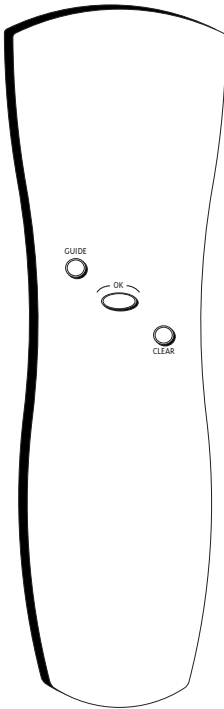

Press **GUIDE** on the remote control to see the **GUIDE Plus+** system. To remove the program guide from the screen, press **OK**, **GUIDE**, or **CLEAR**.

Channel Lineup

If more than one cable company services your area, you may be prompted with a Channel Mapping screen after the first **GUIDE Plus+** system download. You will need to identify your cable company by selecting the correct channel numbers for the stations in question.

- Use the up and down arrow buttons to change the channel group and press **OK** when the correct channel group is highlighted.

Getting In & Out of the **GUIDE Plus+** System

To enter the **GUIDE Plus+** system:

- Press **GUIDE** on the remote.

To exit the **GUIDE Plus+** system:

- Highlight a program and press **OK** to exit the **GUIDE Plus+** system and tune to the channel.
- Press **GUIDE** to exit the **GUIDE Plus+** system and tune to the channel displayed in the video window.
- Press **CLEAR** to exit the **GUIDE Plus+** system and return to the original channel.

The **GUIDE Plus+** System Menu

The **GUIDE Plus+** system offers seven different options on the Menu bar: *Grid*, *Sort*, *News*, *Schedule*, *Messages*, *Editor*, and *Setup*. To access the Menu bar:

1. Press **GUIDE** to access the **GUIDE Plus+** system.
2. Press **MENU** or use the up and down arrow buttons to select the Menu bar (the Grid Guide appears by default).
3. Use the left and right arrow buttons to access other menus.
4. Press **OK**, or **MENU**, or use the down arrow button to see the menu options.

Grid Guide

The Grid Guide appears each time you enter the **GUIDE Plus+** system. It displays the current programming for each channel. The current program is displayed in the video window.

- Press the up and down arrow buttons on the remote to browse channel listings and the channel up and down buttons to page through the listings. Use the right and left arrow buttons to browse future program listings.
- To tune to a channel, highlight the program you want to view in the channel listing and press **OK**. Press **CLEAR** to exit the **GUIDE Plus+** system and return to the original channel. Press **GUIDE** to exit the **GUIDE Plus+** system and tune to the channel in the video window.

Then use the Grid Guide Action buttons as described next.

Using the TV's Features



Grid Guide Action Buttons

Action buttons will change according to where you are in the GUIDE Plus+ system. Be sure to look at the action bar before pressing the command numbers.

When highlighting the program, the following Action buttons appear:

- **Watch** Press 1 on the remote to place a timer in the Schedule for the TV to turn on and tune to the program highlighted in the channel listing. When the TV turns on, the GUIDE Plus+ system will automatically appear with the scheduled program highlighted and tuned in the video window.
- **Go To** Press 2 on the remote to bring up the direct dial box and enter the number of the channel you want. Press OK to highlight the channel and current program in the channel listing of the Grid guide. Press OK again to tune to the highlighted channel. If the video window is unlocked, it will automatically tune to the channel.
- **Record** Press 3 on the remote to place a timer in the Schedule for the VCR to record the program highlighted in the channel listing.

If you have a cable box, changing channels on the TV will not cause the cable box channel to change while recording.

Record will only appear if you have set up the GUIDE Plus+ system and specified your VCR type.

The program information window will display a confirmation when you have successfully scheduled a program to watch or record.

Note: *If you have selected two programs to watch or record which begin at the same time or overlap, you will receive a timer conflict message. You must choose between the two programs.*

When highlighting the Channel names (the left column on the channel listing), the following Action buttons appear:



- **Lock/Unlock** Press 1 to lock or unlock the video window to either stay at one channel as you browse the GUIDE Plus+ system (lock) or change as you browse through different channels (unlock).
- **Go To** Press 2 on the remote to bring up the direct dial box and enter the number of the channel you want. Press OK to highlight the channel and current program in the channel listing of the Grid Guide. If the video window is locked, press OK to tune to the highlighted channel. If the video window is unlocked, it will automatically tune to that channel.

Tip

The PIP button on the remote also toggles the video window between the locked and unlocked states.

Sort menu selection



Categories

Sort

The *Sort* menu lets you browse programs by category. The channel to which you are currently tuned is displayed in the video window.

To Sort:

1. If the GUIDE Plus+ system isn't on your screen, press GUIDE on your remote control.
2. Press MENU on the remote to select the Menu bar.
3. Use the arrow buttons to highlight *Sort*. When *Sort* is highlighted for the first time, the *Movies* category is displayed. Thereafter, the last category used becomes the default. A listing of subcategories is displayed below the category name. Use the left and right arrow buttons to highlight other categories.
4. Use the up and down arrow buttons to highlight a subcategory. For example, highlight *All* and press OK (the GUIDE Plus+ system sorts the programs).
5. Press the up and down arrow buttons to review the list one program at a time. Press the channel up and down buttons to review the list one page at a time. You can also view the next seven days' programming by pressing the right arrow button.
6. Select MENU to return to the menu bar, or press GUIDE or CLEAR to exit the GUIDE Plus+ system.

Then use the Sort Menu Action buttons as described next.



Sort Menu Action Buttons

When viewing the results of a Sort, the following Action buttons appear:

- **Watch** Press 1 on the remote to place a timer in the Schedule, and then follow the on-line help for further options. Placing a timer in the Schedule will cause the TV to turn on and tune to the program highlighted in the channel listing at the predetermined time. When the TV turns on, the GUIDE Plus+ system automatically appears with the scheduled program highlighted and tuned in the video window.
- **Record** Press 3 on the remote to set the VCR to record the program highlighted in the channel listing. If you have a cable box, changing TV channels will not cause the cable box channel to change while recording.

The program information window will display a confirmation when you have successfully scheduled a program to watch or record.

Note: If you have selected two programs to watch or record which begin at the same time or overlap, you will receive a timer conflict message. You must choose between the two programs.

Note: Be sure that during the GUIDE Plus+ system setup you specified that you have a VCR. If you didn't, the RECORD option will not be available.

Using the TV's Features



News

The *News* menu lets you browse current news stories by headline.

1. If the GUIDE Plus+ system isn't on your screen, press GUIDE on your remote control.
2. Press MENU on the remote control to select the menu bar.
3. Use the arrow buttons to highlight *News* (if MSNBC is available on your TV, it will appear in the video window).
4. Use the up and down arrow buttons to highlight a story.
 - Use the up and down arrow buttons to browse the list one story at a time.
 - Use the channel up and down buttons to browse through the list one page at a time.
5. Press the right arrow button to see full text.
6. If there are multiple pages of text, press the right or left arrow button to page forward or back through the pages of text. Press the down arrow button to view the next story.
7. Select MENU to return to the Menu bar, or press GUIDE or CLEAR on the remote to exit the GUIDE Plus+ system.



Schedule

The *Schedule* menu allows you to alter timers for either viewing or recording programs. The GUIDE Plus+ system allows one-touch VCR recording if you have connected the G-LINK cable to your VCR. See Chapter 1 for more details on connecting the G-LINK cable.

To schedule a program to watch or record:

1. If the GUIDE Plus+ system isn't on your screen, press GUIDE on your remote control.
2. Press MENU on the remote to select the Menu bar.
3. Use the arrow buttons to highlight a program within the channel listing.
4. Select *Watch* or *Record* from the Action buttons bar. The timer is then automatically logged into the *Schedule* menu.
5. If you select *Record*, make sure to place a blank tape in the VCR and turn it off.

Note: If you have a cable box connected to your TV and VCR, tune your VCR to the cable box output channel prior to turning off the VCR.

The program information window will display a confirmation when you have successfully scheduled a program to watch or record.

Note: If you have selected two programs to watch or record which begin at the same time or overlap, you will receive a timer conflict message. You must choose between the two programs.

To remove or change the frequency (daily, once, or weekly) of a scheduled event, access the *Schedule* menu from the Menu bar.

1. Press GUIDE to bring up the GUIDE Plus+ system.
2. Press MENU on the remote to select the Menu bar.
3. Use the arrow buttons to highlight the *Schedule* menu selection.
4. Use the up and down arrow buttons to highlight the program you want to edit.

Then use the Schedule Menu Action buttons as described next.



Schedule Menu Action Buttons

When viewing the *Schedule* menu, the following Action buttons appear:

- **Remove** Highlight the *Watch* or *Record* timer you wish to remove from the schedule and press 1 on the remote.
- **Change** Highlight the *Watch* or *Record* timer you wish to change and press 3 on the remote to toggle the frequency between the following choices:

DAILY records the same program each day Monday through Friday.

ONCE records only on that day.

WEEKLY records the program each week at the same time.



Messages

Occasionally you will receive messages regarding your GUIDE Plus+ system, as well as special programming information. You can access these messages from the *Messages* menu on the Menu bar.

To read messages:

1. If the GUIDE Plus+ system isn't on your screen, press GUIDE on your remote control.
2. Press MENU on the remote to select the Menu bar.
3. Use the arrow buttons to highlight the *Messages* menu selection.
4. Highlight the message you want to read by using the up and down arrow buttons.
5. Press INFO to display the full text of the message. If the text continues beyond the screen, press INFO to view the next page of text. Once you have reached the end of the message, press INFO to close the expanded information and return to the *Messages* screen.

Then use the Messages Menu Action button as described next.



Messages Menu Action Button

When viewing the *Messages* menu, the following Action button appears:

- **Remove** Highlight the message you want to delete and press 1 on the remote.

Using the TV's Features

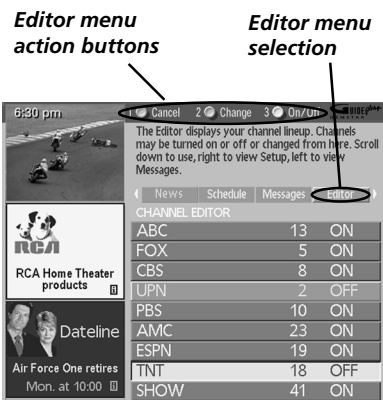

Editor

You can customize the channel listing by enabling or disabling the display of certain channels. For instance, you may disable channels that you never watch. You can restore disabled channels at a later point in time.

1. If the GUIDE Plus+ system isn't on your screen, press GUIDE on your remote control.
2. Press MENU to select the Menu bar.
3. Use the right and left arrow buttons to highlight the *Editor* menu selection.
4. Use the up and down arrow buttons to select a channel.

Then use the Channels Menu Action buttons as described next.



Editor Menu Action Buttons

While browsing the *Editor* menu, the following Action buttons appear:

- **Cancel** Press 1 on the remote to cancel any changes you made since entering the *Editor* Menu.
- **Change** Press 2 on the remote to change the channel number for the highlighted channel line.
- **On/Off** Press 3 on the remote to toggle the state of the channel between *On* and *Off*.

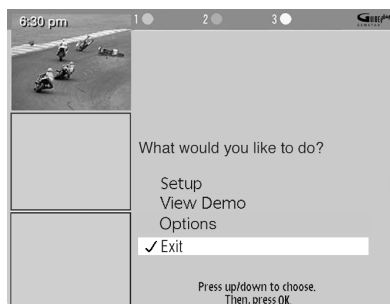

Setup

The *Setup* menu allows you to access the GUIDE Plus+ system setup information. To access the Setup option:

1. If the GUIDE Plus+ system isn't on your screen, press GUIDE on your remote control.
2. Press MENU to select the Menu Bar.
3. Use the right arrow to highlight the *Setup* menu selection.
4. Use the up and down arrows to select *Change system settings*, *Review options*, or *View demo*.
 - **Setup** Displays the GUIDE Plus system setup screens. Setting up the GUIDE Plus+ system is detailed in Chapter 1.
 - **View Demo** Runs the GUIDE Plus+ system demonstration.
 - **Options** Displays the GUIDE Plus+ auto display options.
 - On** Automatically displays the GUIDE Plus+ system when you press the ON•OFF button on the remote control.
 - Off** Disables the GUIDE Plus+ system from being displayed when you press the ON•OFF button on the remote control.



Promotional information

How to Get More Information About an Advertisement or a Program

To find out more information about a program, advertisement or special, use the left arrow button to highlight the channel listing or promotional information box and press the INFO button.

Requesting more information about a particular show displays the PlusCode programming number and the *Shows on Next* for that channel.

Press the INFO button again to exit the expanded information screen.

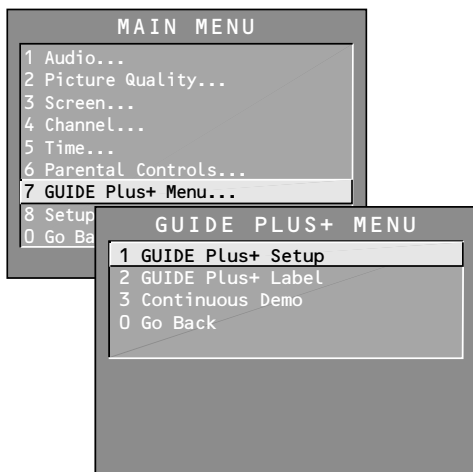

GUIDE Plus+ Menu Items

The *GUIDE Plus+ Menu* gives you access to features in the GUIDE Plus+ system. To access the *GUIDE Plus+ Menu*:

1. Press MENU on the remote.
2. Highlight *GUIDE Plus+ Menu* and press OK.

Each menu and the sub-menus are listed below:

GUIDE Plus+ Setup Displays the GUIDE Plus+ system setup screen.

Setup Setting up the GUIDE Plus+ system is detailed in Chapter 1.

View demo Runs the GUIDE Plus+ system demonstration.

Options Displays GUIDE Plus+ system auto display options.

On Automatically displays the GUIDE Plus+ system when you use the ON•OFF button on the remote to turn on the TV.

Off Disables the GUIDE Plus+ system from being displayed when you use the ON•OFF button on the remote to turn on the TV.

GUIDE Plus+ Label Displays the GUIDE Plus+ label menu.

On Displays the station name when you change channels.

Off The station name isn't displayed when you change channels.

Continuous Demo Runs the GUIDE Plus+ system demonstration until it is turned off. To turn off the demonstration, you must turn off the TV.

Using the TV's Features

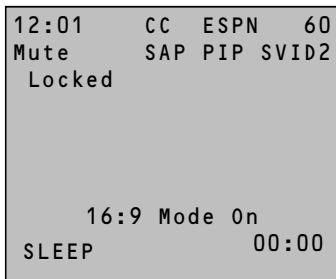

Sample displays on a Channel Banner.

Channel Banner

There are several indicators that might appear when you press the TV or INFO buttons on the remote. This display is called the Channel Banner. The following list describes the items on the Channel Banner screen (left to right and top to bottom).

- 12:01** Displays the current time.
- Locked** Displayed when the Parental Controls are locked.
- CC** Displayed when Closed Captioning is available on the current channel.
- ESPN** Displays the label assigned to the current channel.
- 60** Displays the current channel or input channel.
- Mute**
(or Stereo) Mute is displayed when you mute the audio. Stereo is displayed when the current channel is broadcasting in stereo.
- SAP** Displayed when the current channel is broadcasting SAP (Second Audio Program) information.
- SLEEP** Displayed when the Sleep Timer has been set.
- 00:00** Displayed to count down time left on the commercial skip (SKIP) timer.
- PIP SVID2** Displays the input source, or channel, to which PIP is tuned.
- 16:9 Mode**
On Displayed when the TV is in 16:9 aspect-ratio mode (anamorphic mode) wide-screen viewing.

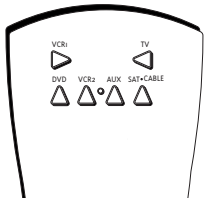

With the autotuning feature, you can set up the TV to tune to the channel you need to watch by pressing that component's button.

Why You Should Use the Autotuning Feature

The autotuning feature automatically tunes the TV to the correct channel for different components you have connected to your TV (like a VCR, DVD Player, etc.) When you set up autotuning in the menu system you don't have to remember to change your TV to channel 3, for example, when you want to watch the tape in your VCR.

How to Set Up the Autotuning Feature

The way you set up the autotuning feature in the TV's menu corresponds to the component buttons on the remote and the way you have each component connected to your TV. When you set autotuning, you're telling the TV what channel to tune to when you press the VCR1, VCR2, DVD, or SAT•CABLE button on the remote control.

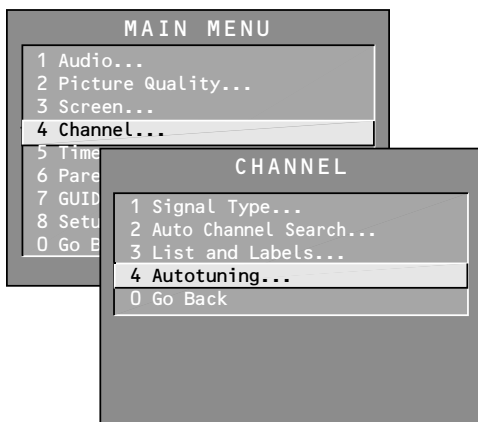

1. Press MENU (the *MAIN MENU* appears).
2. Highlight *Channel* and press OK on your remote control.
3. Highlight *Autotuning* and press OK.
4. Choose which channel you would like to set:

Set VCR 1 Channel Displays a list that lets you set up the channel the TV tunes to when you press the VCR1 button.

Set VCR 2 Channel Displays a list that lets you set up the channel the TV tunes to when you press the VCR2 button.

Set DVD Channel Displays a list that lets you set up the channel the TV tunes to when you press the DVD button.

Set SAT/CABLE Channel Displays a list that lets you set up the channel the TV tunes to when you press the SAT•CABLE button on an RCA satellite receiver remote. (The RCA DTC100 HD receiver is considered a satellite device and can be set up for autotuning using this channel.)

Set SAT2 Channel Displays a list that lets you set up the channel the TV tunes to when you press the DSS2/SAT2 button (or AUX programmed to the 5001 code).

Set RCA WEB Channel Displays a list that lets you set up the channel the TV tunes to when you press the WEB button on an RCA WebTV remote control.

5. Highlight the choice that matches the way you have the component connected to this TV, and press OK.

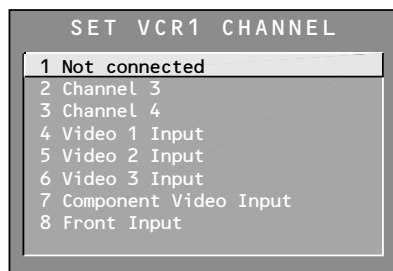

The choices and a brief explanation follow:

Not connected Choose this if you don't have this particular component connected to the TV, or if you don't want the TV to automatically tune to the correct channel when you're using this component.

Using the TV's Features

Notes:

- *To use SAT2 autotuning for a second RCA satellite receiver, program the AUX button using the direct entry method and program the 5001 code. Then set up the SAT2 channel in the Autotuning menu.*
- *To use RCA WEB autotuning for an RCA WebTV remote, set up the WEB channel in the Autotuning menu.*

Channel 3 or 4 Component is connected to the CABLE/ANTENNA jack on the back of the TV, and you want the TV to tune to channel 3 when you press the corresponding button on the remote. Reminder: make sure the component's Channel 3/4 switch is set to channel 3.

Video 1, Video 2, or Video 3 Input Component is connected to a VIDEO or S-Video jack on the back of the TV and you want the TV to tune to a VID input channel when you press the corresponding button. If you're using the S-Video input jacks, they will also be displayed.

Component Video Input Compatible component video source, such as a DVD player or digital TV converter box, is connected to the three COMPONENT VIDEO INPUT jacks (Y•Pb•Pr) on the back of the TV and you want the TV to tune to the component video input channel (CMPNT) when you press the corresponding button.

High Resolution Input Component is connected to the HIGH RESOLUTION INPUT jack on the back of the TV and you want the TV to tune to a high resolution input channel (HiRes) when you press the corresponding button.

Front Input Component is connected to the VIDEO jack on the front of the TV and you want the TV to tune to the front VID input channel (FRONT) when you press the corresponding button.

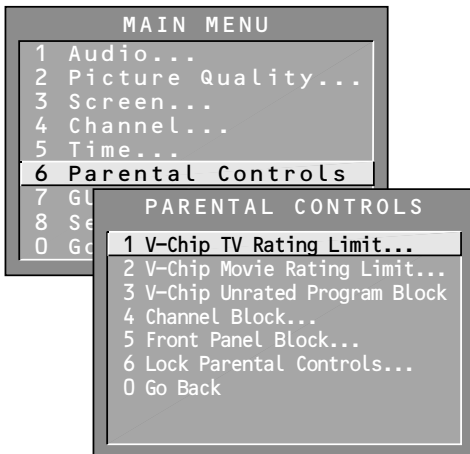

Parental Controls and V-Chip

The *Parental Controls* menu allows you to program your TV so that children cannot see certain programs, channels, or use the front panel controls.

The first three choices in the *Parental Controls* menu involve software inside your TV (referred to as V-Chip) which allows you to block TV programs and movies based on violence, sex, or other content you may believe children should not view. In other words, it lets you program your TV so it won't display certain programs.

Once you block programs, you or other adults can unblock programs by entering a password.

By default, the software inside your TV is turned "off," so if you don't want to use this feature, you can just ignore it.

How V-Chip Works

When turned "on," the V-Chip software reads a code that most broadcasters send with programs. That code tells the software the program's age-based rating (TV-MA, TV-14, etc.) and content themes [(Violence (V), Adult Language (L), etc.)]. If you have blocked the rating and/or content themes that the program contains, you will receive the message, "This channel is not approved for viewing," when you tune to that particular channel.

Broadcasters are not required to provide content themes, so programs received with no content themes will only be blocked if you block their age-based rating. You can also block out programs that have been given a rating of "Not Rated," and programs that are considered "unrated" because no code has been sent by the broadcaster. The TV age-based ratings and content themes you can block are listed in the following table.

Using the TV's Features

Age-Based Rating	Description and Content Themes for Age-Based Ratings
TV-MA	Mature Audience Only. Specifically designed to be viewed by adults and may be unsuitable for children under 17. It contains one or more of the following content themes: crude indecent language (L), explicit sexual activity (S), or graphic violence (V).
TV-14	Parents Strongly Cautioned. Contains some material that many parents would find unsuitable for children under 14. Parents are strongly urged to exercise greater care in monitoring this program and are cautioned against letting children under the age of 14 watch unattended. This program contains one or more of the following content themes: intensely suggestive dialogue (D), strong coarse language (L), intense sexual situations (S), or intense violence (V).
TV-PG	Parental Guidance Suggested. Contains material that parents may find unsuitable for younger children. Many parents may want to watch it with their younger children. The program contains one or more of the following content themes: some suggestive dialogue (D), infrequent coarse language (L), some sexual situations (S), or moderate violence (V).
TV-G	General Audience. Most parents would find this program suitable for all ages. It contains little or no sexual dialogue (D) or situations (S), no strong language (L), and little or no violence (V).
TV-Y7	Directed to Children 7 years and older. Designed for children ages 7 and above. It may be more appropriate for children who have acquired the developmental skills needed to distinguish between make-believe and reality. Themes and elements in this program may include mild fantasy violence (FV) or comedic violence, or may frighten children under the age of 7.
TV-Y	All Children. Themes and elements in this program are designed for a young audience, including children from ages 2-6. It is not expected to frighten younger children.

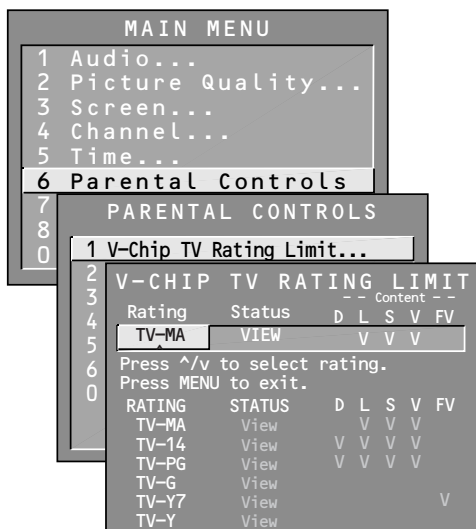

V-Chip TV Rating Limit

The *V-Chip TV Rating Limit* lets you decide which TV programs can and cannot be viewed.

To set TV programming limits:

1. Choose *Parental Controls* from the Main menu. If *Parental Controls* have previously been locked, you must enter your password. If they are not locked, you will get a message reminding you that your limits will not be effective until you lock *Parental Controls*.
2. Press MENU to continue.
3. Highlight and select *V-Chip TV Rating Limit*.
4. Once you get to the *V-Chip TV Rating Limit* screen, use the arrow buttons and OK on your remote to change the status of a TV program rating or content theme from *View* to *Block*.

The following sections give you more details about how to change the status of TV program limits.

The V-Chip Rating Limit Screen

The following is an example of where items are located within the Rating Limit screen.

Rating Status Field
Lets you select whether the status of the age-based rating limit to the left is View or Block.

Rating Field
Lets you select from a list of age-based ratings you can block or view.

Content Themes
Lists the content themes you can block or view.

Content Status Fields
Lets you select which content themes to view for the selected rating, and whether the status of the content theme is currently View (V) or Block (B).

RATING	STATUS	D	L	S	V	FV
TV-MA	View		V	V	V	
TV-14	View	V	V	V	V	
TV-PG	View	V	V	V	V	
TV-G	View					
TV-Y7	View					V
TV-Y	View					

Rating Settings Area

Lets you see the current block/view state of age-based ratings and associated content. The View (V) settings are coded in green, and the Block (B) settings are coded in red.

Rating field **Rating status field** **Content status fields**

RATING	STATUS	D	L	S	V	FV
TV-MA	Block		B	B	B	
TV-14	Block	B	B	B	B	
TV-PG	Block	B	B	B	B	
TV-G	View					
TV-Y7	View					V
TV-Y	View					

Tip

When you change the status of a rating to Block, the system will automatically block higher ratings and all corresponding content themes.

Blocking Age-Based Ratings

You can automatically block all program ratings above a specified age-based rating level. For example, if you only want your child to watch programs that have a TV-G rating and lower (in other words, you want the child to watch TV-G, TV-Y7, and TV-Y), then you need to block out other programming with higher ratings.

To block programs with higher ratings:

1. First, determine the lowest level rating you don't want the child to watch (see chart of age-based ratings on next page).
2. Press the left and right arrow buttons to highlight the *Rating* field.
3. Press the up and down arrow buttons on the remote to scroll through the age-based rating limits. Keep scrolling until the rating corresponding with the lowest rating you do not want the child to watch appears on the screen.

In the example discussed above, you would scroll through the *Rating* field until TV-PG appears, since the highest rating you want the child to watch is TV-G.

(Steps continued on next page)

Using the TV's Features

Hierarchy of Age-Based Ratings	
TV-MA	Mature Audience Only
TV-14	Parents Strongly Cautioned
TV-PG	Parental Guidance Suggested
TV-G	General Audience
TV-Y7	Directed to Children 7 years and older
TV-Y	All Children

4. Press the right arrow button to move the yellow highlight to the *Status* field.
5. Press the up or down arrow button to toggle between *View* and *Block*. The status for the rating listed to the left and all higher ratings automatically changes to *Block* (and *B*).
6. Press OK on the remote to return to the menu or exit the screen when you are finished.
7. Select *Lock Parental Controls* from the *Parental Controls* menu. Enter a password, and if you have not already set your password, you will be prompted to enter it again to confirm.

Tip

To reset the ratings to *View* and *V*, press the **RESET** button on the remote.

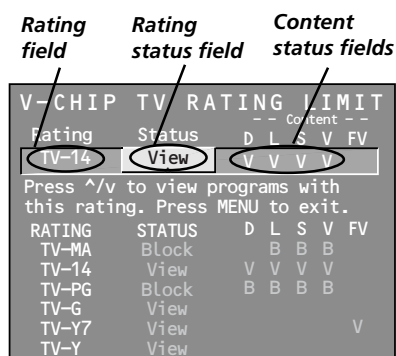

Viewing Age-Based Ratings

After you block age-based ratings, you have the option of changing some of the ratings back to *View*.

1. Determine which blocked rating you want to view.
2. Use the up and down arrow buttons to select the rating with a status of *Block*.
3. Press the right arrow button to move the yellow highlight to the rating status field.
4. Press the up button to select *View*.

Notes:

- The content status fields corresponding to the unblocked rating become *View* as well. They and the age-based rating status are the only fields that automatically change back to *View* when you complete this process.
- You must remember to lock Parental Controls for rating limits to take effect.

Content Themes	
D	Sexually explicit dialogue
L	Adult language
S	Sexual situations
V	Violence
FV	Fantasy Violence
TV-Y	All Children

Blocking Specific Content Themes

You can block programs based on their content. (Content is represented by the D, L, S, V, FV and TV-Y on your screen. See the beginning of this section for details.) When you block a content theme for a particular rating, you automatically block that content theme for higher rated programs as well.

For example, if you do not want your child to watch programs that have adult language (L) rated TV-PG or higher, then you could block out all programming TV-PG and above containing adult language.

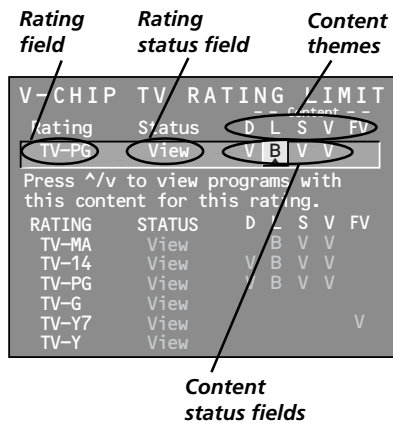

To block program content:

1. Determine the lowest level of content you don't want the child to watch.
2. Use the up and down arrow buttons on the remote to scroll through the age-based ratings until the rating that corresponds with the lowest content you do not want the child to watch appears. (In the example above, you would scroll through the ratings until the TV-PG rating appeared.)
3. Press the right arrow button to move the highlight to the field corresponding with the content theme you want to block out.
4. Press the up or down arrow button to change content status from *V* to *B*. All higher ratings' content theme will automatically change to *B*.
5. Press OK to return to the menu or exit the screen.

Notes:

- Broadcasters are not required to provide content themes or age-based ratings. Programs received with no content themes will only be blocked if you block their age-based rating.
- You must remember to lock Parental Controls for rating limits to take effect.

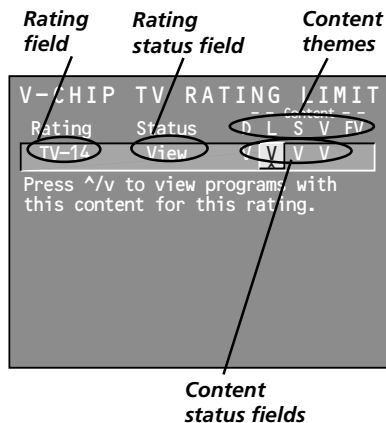

Viewing Specific Content Themes

If you block specific content themes, you have the option of going back and changing some of the content themes back to (*V*) *View*:

1. Determine the content themes you want to change to (*V*) *View*.
2. Use the up and down arrow buttons to scroll through the age-based ratings until the rating whose content theme you want to change to *View* appears.
3. Press the right arrow button to move the yellow highlight to a particular content theme status, such as the *B* under language (*L*) corresponding with TV-14.
4. Press the up or down arrow button to change its status back to *V*. Your child would then be able to watch programs with TV-14 adult language content, but not programs with TV-PG or TV-MA language content.

Note: Only the content theme status corresponding to TV-14 (*L*) language changes to (*V*) *View*. Higher rated content themes, such as that for TV-MA language, do not change.

Using the TV's Features

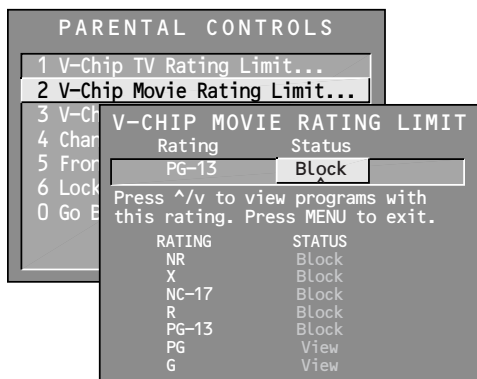

V-Chip Movie Rating Limit

You set movie rating limits by blocking movies rated above a specified level. How to block movie ratings and view movie ratings is explained in the next two sections.

To access the *V-CHIP MOVIE RATING LIMIT* menu:

1. Press MENU on the remote control (the *TV MAIN MENU* appears).
2. Select *Parental Controls* (press 6).
3. Select *V-Chip Movie Rating Limit* (press 2).

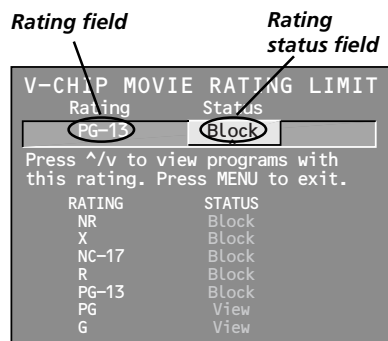

Blocking Movie Ratings

If you only want your child to watch movies that have a PG rating and lower (in other words, movies rated PG and G), then you could automatically block out all other movies with higher ratings.

To block movies:

1. Highlight the *Rating* field and press the up and down arrow buttons to find the rating that is the lowest rating you don't want the child to watch. (In the example above, you would highlight the rating status button corresponding to PG-13, since the highest rating you want the child to watch is PG.)
2. Press the right arrow button to highlight the rating *Status* field. Press the up and down arrow buttons to change the button from *View* to *Block*. All higher ratings automatically change to *Block*.
3. Press OK to return to the menu or exit the screen.
4. If Parental Controls are not locked, you must lock them so the movie rating limits will take effect.

Note: Some movies may be given a Not Rated (NR) rating. After blocking movie ratings, you must set NR to View separately to view NR movies.

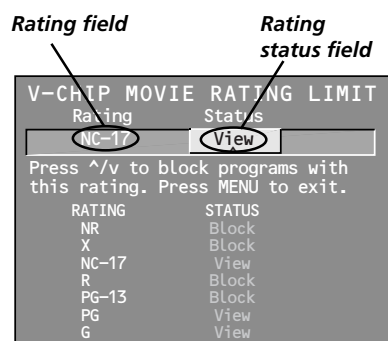

Viewing Movie Ratings

After you block movie ratings, you have the option of changing some of the rating status buttons back to *View*:

1. Highlight the *Rating* field and press the up and down arrow buttons to find the rating you want to view.
2. Press the right arrow button to highlight the rating *Status* field. Press the up and down arrows to change the button from *Block* to *View*.

For example, if movies with a rating of PG-13 and higher are blocked, you can change the rating status corresponding with NC-17. Your child would then be able to watch all movies with a G, PG, and NC-17 Rating.

3. Press OK to exit the screen, and be sure parental controls are locked.

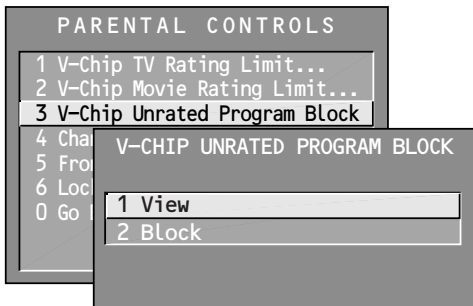

V-Chip Unrated Program Block

Selecting this option lets you decide if programs that the V-Chip recognizes as “unrated” can be viewed. Note that “unrated” TV programs may include news, sports, political, religious, local and weather programs, emergency bulletins, public announcements, and programs without ratings.

View All unrated programs are available.

Block All unrated programs are not available.

Note: You must remember to lock Parental Controls for rating limits to take effect.

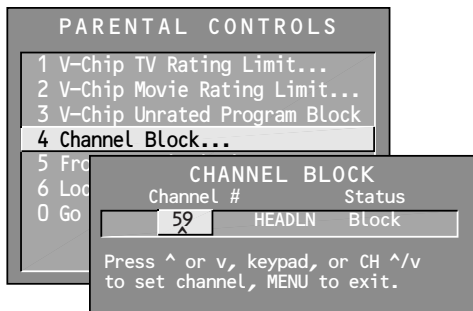

Channel Block

Selecting this option lets you decide what channels can be viewed.

View Makes the selected channel viewable.

Block The front panel and remote control CH (channel) buttons will tune only to channels that you have marked as *View*. The remote will still tune to the blocked channel if you use the digits to access the channel, but the channel will be blocked.

Don't forget to lock parental controls after you change the status of *Channel Block*. If you do not, the channel block will not take effect.

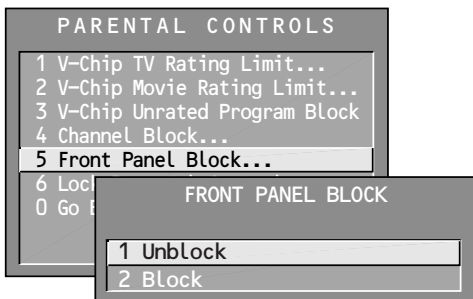

Front Panel Block

Selecting this option lets you block (disable) or unblock (enable) the TV's front panel. The remote still tunes to any channel. *Front Panel Block* can:

- Keep children from watching TV when the parent is not present.
- Keep young children from playing with the buttons.

(When using this as a Parental Control method, you should remove access to any remote that is capable of operating the television while you have the front panel blocked.)

Don't forget to lock parental controls after you change the status. If you do not, the front panel block will not take effect.

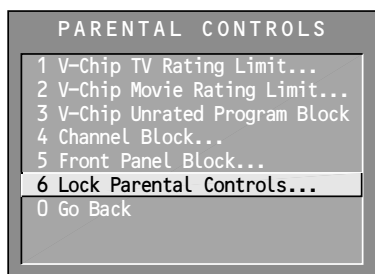

Lock/Unlock Parental Controls

Selecting this option lets you lock and unlock parental controls settings using a password.

If you do not lock parental controls, none of the settings for V-Chip, Channel Block, or Front Panel Block will take effect.

If you forget your password, simultaneously press and hold MENU/OK on the television and the TV button on the remote for 3 seconds. Parental Controls unlock and you can re-enter a password via *Lock Parental Controls*. Your parental controls settings will not be affected.

Using the TV's Features

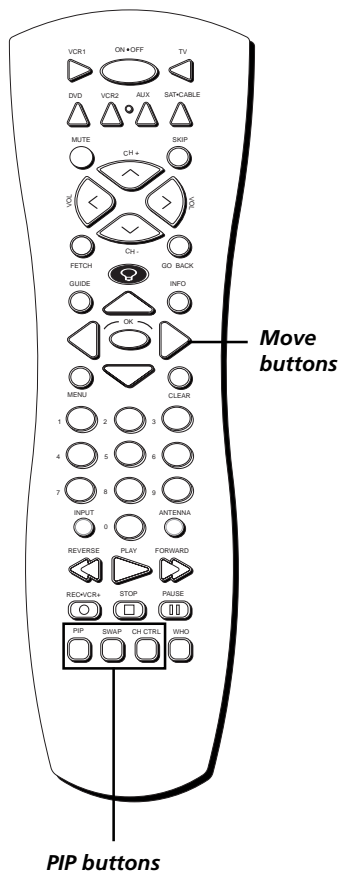

PIP (Picture-in-Picture) Operation

The PIP (picture-in-picture) feature lets you display a second, smaller picture on top of the main picture. Note that PIP is not available for high resolution or component video sources.

PIP Buttons

There are four remote buttons that control the way the PIP window works:

PIP Brings up the PIP window. Press PIP again to remove the window.

Move buttons Let you move the PIP window to different areas of the screen.

SWAP Switches, or “swaps,” the video from the PIP window with the main picture.

CH CTRL (Channel Control) Lets you switch channel control between the PIP window and the main picture. To determine whether you are controlling the PIP or the main picture, bring up the Channel Banner (detailed on page 42). The yellow channel number is the one you are controlling.

For instance, press PIP to bring up the PIP window. You can change channels by entering digits or pressing the channel up or down. When you press the CH CTRL button, the channel control switches to the main picture. You can now change channels in the main picture by entering digits or pressing channel up or down.

Tips for Using the PIP Buttons

Skip to PIP: Channel Surfing in the Main Picture

You can surf through the channels during commercial breaks using the SKIP and CH (channel) buttons.

1. Press SKIP to set the commercial skip timer and bring up the PIP window.
2. Press the channel up or down buttons on the remote to surf through the channels in the main picture. When the SKIP feature times out, the main picture will tune to the original channel automatically.

Channel Surfing in the PIP Window

You can use the PIP window to surf through channels as well.

1. Press PIP to bring up the PIP window.
2. Press the channel up or down buttons. The TV begins displaying each channel in the PIP window. If you see a channel that interests you, press SWAP to put that channel in the main picture.

Tip

A typical use of SWAP is to scan through channels in the PIP window, and when you find a channel you like, press SWAP to display that channel in the main picture, sending the current channel to the PIP window.

Using the TV's Menu System

Chapter Overview:

- How to Use Your TV's Menu System
- Audio Menu
- Picture Quality Menu
- Screen Menu
- Channel Menu
- Time Menu

Changing Entertainment. Again.



Using the TV's Menu System

How to Use Your TV's Menu System

You use the buttons on the remote or the front of your TV to access the menu system and make changes to the settings.

The following pages explain how to use the different types of menus to adjust the features of your TV.

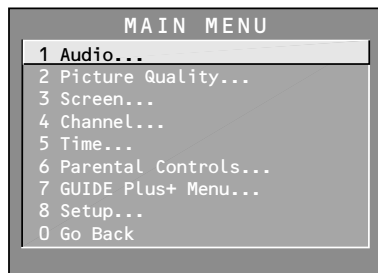

Tip

Feel free to explore the menu system. If you're ever unsure where you are in the menu system, or you're just plain tired of exploring, press CLEAR to remove the menus from the screen and start over again.

Menus

The first menu is called the Main menu. Press MENU on the remote or on the front panel to bring up the Main menu.

Menus take you to another menu or a control panel. There are two ways to select a choice in a menu:

- Use your arrow buttons on your remote control or front panel to highlight your choice, and press OK.
- Press a number button on the remote. For example, in the Main menu press 3 to go straight to the *Screen* menu.

Exiting a menu

There are three ways to exit a menu:

- Highlight *Go Back* and press OK.
- Press 0 on the remote.
- Press CLEAR. The on-screen displays are cleared from the screen and you return to TV viewing.

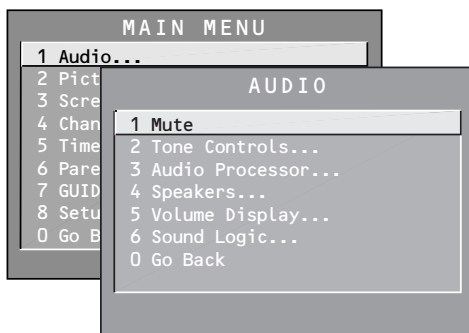

Audio Menu

Mute Press OK to reduce the TV's volume to its minimum level. Press OK again to restore the volume.

Tone Controls Displays the slider controls for adjusting the TV's treble, bass and balance.

Audio Processor Displays a choice list of available audio modes, which control the way the sound comes through your speakers.

Mono Plays the sound in mono only. Use this setting when receiving broadcasts with weak stereo signals.

Stereo Splits the incoming stereo audio signal into left and right channels. Most TV programs and recorded materials have stereo audio. The word *Stereo* appears on the TV when you tune to a program that is broadcast in stereo.

Using the TV's Menu System

SRS Stereo (•) SRS technology is an audio processing technology that adds greater depth and stereo separation to stereo audio signals.

SRS Stereo (•) — Focus This technology enhances audio signals by adding treble and making dialog more understandable.

Second Audio Program (SAP) Plays the program's audio in a second language, if one is available. The TV displays the word SAP in the channel marker when you tune to a program that is broadcast with SAP information. SAP audio is broadcast in mono. SAP is also used to broadcast a program's audio with descriptions of the video for the visually impaired.

Speakers Displays a choice list that lets you turn the TV's speakers on or off.

Volume Display Displays a choice list that lets you turn off the TV's volume display if you have an audio receiver connected to the fixed audio output jacks.

Sound Logic™ Sound Logic monitors a program's audio track and limits the volume to a maximum volume range. Whenever you adjust the volume on the TV, the maximum volume range adjusts, too.

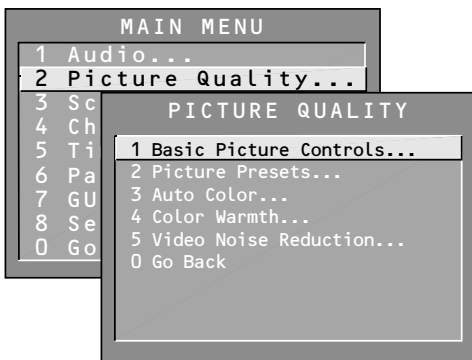

Picture Quality Menu

Basic Picture Controls Displays the five slider controls for adjusting the way the picture looks.

Contrast Adjusts the difference between the light and dark areas of the picture.

Color Adjusts the richness of the color.

Tint Adjusts the balance between the red and green levels.

Black Level Adjusts the brightness of the picture.

Sharpness Adjusts the crispness of the edges in the picture.

When exiting this menu, the *Save Personal Picture Preset* choice list will appear. You can choose either *Yes* or *No*. If you save the settings as a Personal Picture Preset, the TV will store the settings so you can re-select them quickly if someone changes the settings.

Picture Presets Displays a choice list that lets you select one of three preset picture settings: *Bright Lighting*, *Normal Lighting*, *Soft Lighting* or *Personal Picture Preset*. Choose the setting that is best for your viewing environment.

Auto Color Displays a choice list that lets you turn on the feature that automatically corrects the color of the picture. (This is especially useful for tracking realistic flesh tone colors as you switch from channel to channel.) Choose *On* or *Off*, depending on your preference.

Color Warmth Displays a choice list that lets you set one of three automatic color adjustments: *Cool* for a more blue palette of picture colors; *Normal*; and *Warm* for a more red palette of picture colors. The warm setting corresponds to the NTSC standard of 6500 K.

Note: The Basic Picture Controls menu affects both the TV controls and the GUIDE Plus+ system. Once you have adjusted the basic picture controls, you might want to bring up the GUIDE Plus+ system to check the changes.

Note: Auto Color only appears in the Picture Quality menu when the following modes are selected: Tuner, Vid 1-3, Front, and S-Video. This feature does not appear in the Picture Quality menu if the TV is tuned to CMPNT or HiRes inputs.

SRS, Sound Retrieval System, and the SRS logo are registered trademarks of SRS Labs, Inc.

Using the TV's Menu System

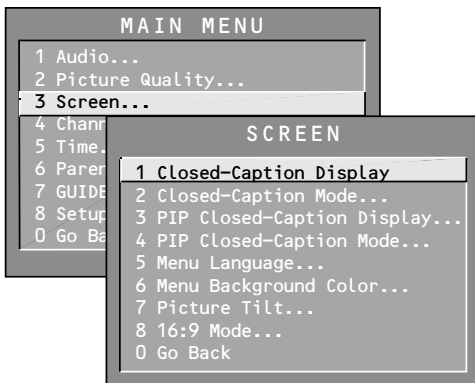

Screen Menu

Closed-Caption Display Displays a choice list that lets you choose the way closed captioning information is shown on the screen. Closed-captioning is not available with the high resolution input.

Off No captioning information displayed.

On Always Captioning information shown always, when available.

On when sound is muted Displays captioning information, when available, whenever the TV's sound is muted by pressing the MUTE button. The captioning information is not displayed when the sound is not muted.

Closed-Caption Mode Displays a choice list that lets you choose which captioning mode is used for displaying captioning information. If you are unsure of the differences among the modes, you may prefer to leave the closed captioned mode set to CC1, which displays complete text of the program in the primary language in your area.

PIP Closed-Caption Display Displays a choice list that lets you choose the way closed captioning information is shown in the PIP window.

Off No captioning information displayed.

On Captioning information shown always, when available.

Alternate with PIP button Displays captioning information, when available, by pressing the PIP button while the PIP window is displayed.

PIP Closed-Caption Mode Displays a choice list that lets you choose which captioning mode is used for displaying captioning information within the PIP window.

Menu Language Displays a choice list that lets you select your preferred language for the menus: *English*, *Spanish* or *French*.

Menu Background Color This menu item lets you choose between blue and transparent menu backgrounds.

Picture Tilt Your TV has an extra-large picture tube, which makes it vulnerable to the effects of the Earth's magnetic field. You may need to adjust the picture tilt. Use the left and right arrow buttons adjust the picture tilt.

Using the TV's Menu System

Tip

You can turn 16:9 mode on/off from the menu or the **FETCH** button on the remote. If you are using a **DTC100** remote, you can use the **FETCH** button with the remote in the TV mode.



16:9 Mode Also known as anamorphic mode. Lets you select a widescreen format for a wider viewing area using a 16:9 aspect-ratio source, such as a DVD player, for display on this 4:3 aspect-ratio TV. Requirements include a 16:9 aspect-ratio source, such as a DVD player or HD receiver; a 16:9 aspect-ratio disc or signal; the 16:9 source needs to be set to output a 16:9 format signal; and the 16:9 mode on the TV needs to be on.

Important: Prolonged use of 16:9 mode will result in visible darkening of the picture tube. To maintain screen quality, do not operate in 16:9 mode for extended periods of time.

Notes:

- When using 16:9 mode, the on-screen displays (menus, guide, CC, and PIP) will be compressed somewhat, which is normal.
- A separate 16:9 mode setting is retained for the tuner, video, component, and high resolution inputs. If the TV is turned off, all 16:9 mode settings are retained.

Using Closed Captioning

Many programs are encoded with closed-captioning information, which lets you display the audio portion of a program as text on the TV screen.

Closed captioning is not available on all channels at all times. Only specific programs encoded with closed-captioning information are applicable. When a program is closed captioned, *CC* is displayed in the channel banner. See Chapter 3 for more information about the channel banner.

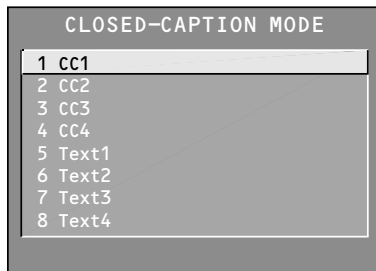

Tip

If you don't know which Closed-Caption mode to use, select **CC1**. **CC1** is probably the mode that is used in your area. **CC2**, **CC3**, and **CC4** are reserved for foreign languages, but are rarely used at this time.

Closed-Caption Modes

The TV offers eight closed-captioned modes, including four text modes.

To set the *Closed-Caption Mode*:

1. Select *Screen* from the Main menu.
2. Highlight *Closed-Caption Mode* and press **OK** (the *Closed-Caption Mode* appears).
3. Highlight your choice and press **OK** (the *Screen* menu appears again).

Note: The *Text* modes cover nearly half of the picture on the screen to display the closed-captioned text. Most broadcasters use the *CC* mode, which displays a few lines of captions at a time.

Turning off Closed-Caption

1. Select *Screen* from the Main menu.
2. Press **OK** to select *Closed-Caption Display*.
3. Highlight *Off Always* and press **OK**. The closed captioning is turned off and you go back to the *Screen* menu.

Using the TV's Menu System

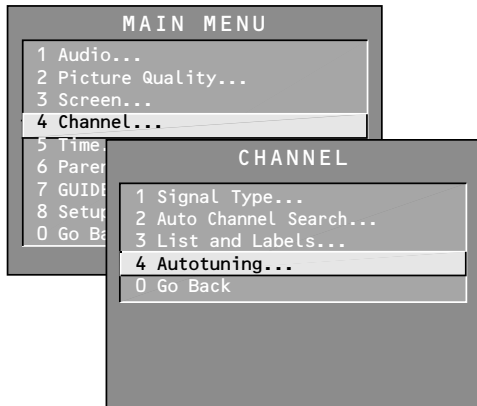

Tip

To enter a channel number greater than 99, press and hold "1" to enter the hundreds digit, then press the two remaining numbers.

Channel Menu

Signal Type Displays a choice list that lets you select the current antenna type. This option does not appear when the GUIDE Plus+ system is set up.

UHF/VHF Antenna Choose this if you are currently using an over-the-air antenna for TV signals.

Cable TV Choose this if you are currently using cable or a cable box for TV signals.

Auto Channel Search Tells the TV to search automatically for all the channels available through the antenna input. When the TV finds an active channel, it places it in the Normal channel list; inactive channels (weak stations or channels with no signal at all) will be removed from the channel list. If you are using a cable box and have set up the GUIDE Plus+ system, this option does not appear.

List and Labels Displays a control panel that lets you edit your Normal channel list and choose a six-character label for each channel. Follow the on-screen directions to enter your channels and other information.

Channel # Use the up and down arrow buttons to scroll up and down through the channels available via your antenna. You can enter the channel number directly using the number buttons.

Normal List Only the channels included in the Normal list are available when you scan up and down using channel up and down. Use the up and down arrow buttons to indicate whether the channel number indicated is included (Yes) or is not included (No) in the Normal channel list.

Channel Label Use the up and down arrow buttons to enter a six-character label for each channel. Hold the button down to scroll quickly through the characters. The TV can store up to 45 labels in memory.

Autotuning Displays a choice list that lets you set up the TV to automatically tune to the correct input channel when you press a component button (VCR1, DVD, VCR2, SAT•CABLE, etc.) on the remote. Go to Chapter 3 for details about the Autotuning feature.

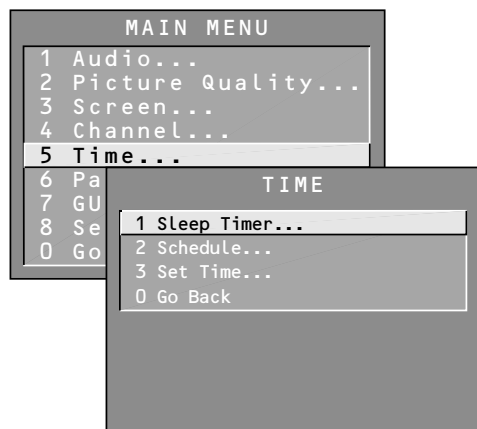

Time Menu

Sleep Timer Displays a control panel that lets you select the amount of time you want to give the TV before it shuts itself off.

Schedule Displays a control panel that lets you set up a schedule for turning the TV on and off automatically. Reminder: you must turn the schedule On. The on-screen directions guide you through the steps needed to set the schedule.

Set Time Displays a control panel that lets you enter the current time. The on-screen directions guide you through the steps needed to set the time. If your GUIDE Plus+ system is set up, it will automatically update your time and this option will not appear.

Other Information

Chapter Overview:

- Troubleshooting
- Specifications
- Care and Cleaning
- Limited Warranty
- Accessory Order Form
- Index

Changing Entertainment. Again.



Troubleshooting

Most problems you encounter with your TV can be corrected by consulting the following troubleshooting list.

TV Problems

TV won't turn on

- Press the TV button.
- Make sure the TV is plugged in.
- Check the wall receptacle (or extension cord) to make sure it is “live” by plugging in something else.
- Something might be wrong with your remote control. Press the POWER button on the front of the TV. If the TV turns on, check the remote control solutions on page 62.
- The front panel controls may be locked (disabled). Use the remote control to unlock the front panel controls by selecting the *Front Panel Block* in the *Parental Controls* menu and choosing *View*.

Buttons don't work

- If you're using the remote control, press the TV button first to make sure the remote is in TV mode.
- The front panel controls may be locked (disabled). Use the remote control to unlock the front panel controls by selecting the *Front Panel Block* in the *Parental Controls* menu and choosing *View*.
- Unplug the TV for two minutes and then plug it back in. Turn the TV on and try again.

TV turns off while playing

- Scheduled Off function may have been activated. Go to page 38 for instructions.
- Electronic protection circuit may have been activated because of a power surge. Wait 30 seconds and then turn on again. If this happens frequently, the voltage in your house may be abnormally high or low.
- The sleep timer may be set.
- Unplug. Wait five minutes. Plug in again.

TV turns on unexpectedly

- Scheduled On or Watch from the GUIDE Plus+ system may have been activated. Go to page 38 for instructions.

Blank screen

- Make sure the component connected to the TV is turned on.
- Try another channel.
- If you have connected a digital set top converter (i.e. DTC100), you must connect to both the HIGH RESOLUTION INPUT and INPUT2 jacks in order to view both digital and analog signals.
- Due to copyright restrictions, you may not be able to view some high definition programs in high definition format using this product. To view this type of programming in standard definition format, you must also connect the audio/video jacks from the HD receiver to the TV.

When I turn on the TV, an icon is moving on the screen

- Make sure you have removed the Demo Pin from the G-LINK jack on the back of your TV.

No sound, picture okay

- Maybe the sound is muted. Try pressing the volume up button to restore sound.
- Maybe the speakers are turned off. Check the Audio Output and Speakers control panel in the Audio menu.
- If using an S-VHS component, remember to also connect the component's L and R AUDIO OUT jacks to the TV's L and R INPUT jacks.
- Check the INT/EXT switch on the back of the TV.

Can't select certain channel

- Channel may be blocked or not approved in the *Parental Controls* menu.
- If using a VCR, check to make sure the TV/VCR button on the VCR is in the correct mode (press the TV/VCR button on your VCR).

Noisy stereo reception

- May be a weak station. Use Audio menu to choose *mono* sound.

No picture, no sound but TV is on

- Maybe the cable/air function is set to the wrong position. Select *GUIDE Plus+ Menu* from the Main menu, select the *Setup* option, and provide the correct information on the following screens. Go to pages 19-21 for detailed instructions.
- The channel might be blank — change channels.
- If you're watching your VCR and it's connected with coaxial cable to the CABLE/ANTENNA jack, tune the TV to channel 3 or 4 (whichever channel is selected on the 3/4 switch on the back of your VCR). Also check to make sure the TV/VCR button on the VCR is in the correct mode (press the TV/VCR button on your VCR).

Sound okay, picture poor

- Check antenna connections. Make sure all of the cables are firmly connected to the jacks.
- Try adjusting sharpness function to improve weak signals. Go to page 55 for more instructions.

Black box appears on the screen

- Closed-captioning might be on. Check the *Closed-Caption Display* control panel in the *Screen* menu. Go to page 57 for more instructions.

Every time I turn on the TV, the Guide is on the screen

- The GUIDE Plus+ system automatically appears on the screen when you use the TV button on the remote to turn on the TV. You can turn off this feature by pressing GUIDE on your remote control and then select the Menu bar. Press the right arrow button to select *Setup*. Choose *Review options* and select *OFF*.

GUIDE Plus+ System Problems

GUIDE Plus+ setup won't switch to channel 9 for VCR and/or channel 02 cable box

- Make sure you have removed the Demo Pin from the G-LINK jack. Check to see if the G-LINK wands are positioned correctly in front of components' remote sensors.
- GUIDE Plus+ system control of cable box is slower than direct control of the box itself. Keep this in mind when changing channels.
- You may have an incorrect GUIDE Plus+ Channel Lineup. The guide may get out of sync with the cable provider. Use the *GUIDE Plus+ Setup* in the *GUIDE Plus+ Menu* to change the zip code to 99999. Turn the TV off for 10 minutes. Use Setup again to change the zip code back to the correct value. If asked, be sure to select the correct channel lineup from the on-screen list.

(Continued on next page)

Other Information

Program information doesn't download

- Review your setup information and make sure it's correct. Press MENU on the remote and select *GUIDE Plus+ Setup*. Go to page 19 for detailed instructions about the GUIDE Plus+ Setup menus.
- The TV must be off to download information. Leave your TV off overnight, for at least 10 hours, to receive the initial download for your area.
- If you're using a cable box, leave it on so you can receive program information.

Scheduled Watch or Record doesn't occur

- Check Schedule for timer conflicts. Go to page 38 for instructions.
- Make sure the wands of the G-LINK cable are placed in front of the remote sensor(s) on the component(s).
- Make sure your VCR is turned off during the time you've scheduled to record a program because the system turns the VCR on when it starts recording (if it's already on when recording starts, the system will turn it off).
- Make sure there is a tape in the VCR and that the VCR is connected properly.
- Be sure that you set up the VCR in the *GUIDE Plus+ Setup* menus. If you don't complete the *Configuring for a VCR* steps successfully, the Record option won't be available. Go to page 22 for detailed instructions.
- If a cable box is attached to your TV, make sure you set it up correctly in the *GUIDE Plus+ Setup* menus. Go to page 20 for detailed instructions.

The Remote Control Doesn't Work

- Something might be between the remote and the remote sensor on the component. Make sure there is a clear path.
- Maybe the remote isn't aimed directly at the component (TV or VCR) that you're trying to operate.
- Maybe remote is not in TV Mode. Press the TV button so remote will control TV.
- Maybe batteries in remote are weak, dead, or installed incorrectly. Put new batteries in the remote. (Note, if you remove the batteries, you may have to reprogram the remote to operate other components.)
- You might need to drain the remote's microprocessor: remove batteries and press the number 1 button for at least 60 seconds. Release the 1 button, replace the batteries, and (if necessary) program the remote again.

Problems with V-Chip/Parental Controls

The rating limits don't work

- You must lock the settings. Go to the *MAIN MENU* (press MENU on your remote), select *Parental Controls* (press 6 on your remote), select *Lock Parental Controls* (press 6 on your remote).

I don't remember my password and I want to unlock the TV

- If you forget your password, simultaneously press and hold MENU/OK on the television and TV on the remote for 3 seconds. Nothing appears on the screen, Parental Controls simply unlock and you can re-enter a password via *Lock Parental Controls*.

The V-Chip won't let me watch a program even though it's not rated as violent.

- Maybe the movie was given an NR (Not Rated) status. After you block movie ratings, you must set NR to *View* separately in order to view movies with an NR rating.

RCA HDTV Monitor Specifications*

PICTURE	Optimum Contrast Screen	Yes
	Picture Power (Watts)	65
	Dot Pitch78mm
	Dynamic Focus	Yes
	Scan Velocity Modulation	Yes
	Aperture Sharpness	Yes
	Comb Filter	3 Line Digital Comb
	Auto Color Control	Color Level & Tint
	Black Stretch	Yes
	Color Detail Enhancement	Yes
	Wide Band Video Amplifier	Yes
	Video Noise Reduction	Yes
	Color Temperature Selections	6500, 7500 & 9300 Kelvin
	MULTI-SYNC SCAN MODES	NTSC
HDTV		1280x1080 Interlaced
SOUND	Audio Power (Watts) Total	20 (10 Watts/Ch)
	DBX† Broadcast Stereo	Yes
	Second Audio Program	Yes
	SRS / Sound Retrieval System with Focus	Yes
	Speakers	2 - 55mm x 160mm High Compliance
CONVENIENCE	Channel Tuning Capability	181
	Gemstar GUIDE+ Gold	Yes
	16:9 Aspect-Ratio Mode (Widescreen)	Yes
	Dual Tuner Picture-in-Picture	Yes
	PIP, Swap, and Move	Yes
	Channel Labeling	Yes
	Parental Control	Yes
	Stereo Headphone Jack	3.5mm Stereo Mini-jack
Front A/V Input	Composite, L (Mono)/ Right	
BACK PANEL INPUTS/OUTPUTS	A/V Inputs	3 - S-Video / Composite
	Component Video Input	Y-Pr-Pb (RCA Jacks) Synchronscan
	UHF/ VHF, Cable Input	75-ohm Terminal
	High Resolution Input	15 Pin D-sub
	• RGB Video Input	
	• Component Video Input (with provided adapter cable)	
	Audio Output Jacks	Fixed And Variable
External Speaker Terminals	Yes	
G-LINK jack	Yes	
GENERAL SPECIFICATIONS		D36120
	Screen Size (Measured Diagonally)	36"
	Dimensions (H X W X D)	28.5 X 38.75 X 26.5"

* Specifications are subject to change.

† DBX is a registered trademark of Carillon Electronics Corporation.

Other Information

Care and Cleaning

CAUTION: Turn OFF your TV before cleaning.

You can clean the TV as required, using a soft lint-free cloth. Be sure to occasionally dust the ventilation slots in the cabinet to help assure adequate ventilation.

The TV's screen may be cleaned with a soft, lint-free cloth as well. Take care not to scratch or mar the screen. If necessary, you may use a cloth dampened with warm water.

Never use strong cleaning agents, such as ammonia-based cleaners, or abrasive powder. These types of cleaners will damage the TV.

While cleaning do not spray liquid directly on the screen, or allow liquid to run down the screen and inside the TV. Also, avoid placing drinks or vases with water on top of the TV. This could increase the risk of fire or shock hazard or damage to the TV.

Limited Warranty

What your warranty covers:

- Defects in materials or workmanship.

For how long after your purchase:

- One year from date of purchase for labor.
- One year from date of purchase for parts.
- Two years from date of purchase for the picture tube.

The warranty period for rental units begins with the first rental or 45 days from date of shipment to the rental firm, whichever comes first.

What we will do:

- Pay an Authorized Service Center the labor charges to repair your unit.
- Pay an Authorized Service Center for the new, or at our option, refurbished replacement parts and picture tube required to repair your unit.

How you get service:

- Call 1-877-RCA-HDTV and have your unit's date of purchase and model number ready.
- A representative will troubleshoot your problem over the phone.
- If the representative determines that you should receive service, they will provide you with the name(s) of the Authorized Service Center in your area.
- Contact the Service Center and arrange for home or pick up, repair, and return service, provided that your unit is located within the geographic territory covered by an Authorized Service Center. If not, you must take your unit to the Service Center location at your own expense, or pay for the cost the Service Center may charge to transport your unit to and from your home.
- Proof of purchase in the form of a bill of sale or receipted invoice which is evidence that the product is within the warranty period must be presented to obtain warranty service. For rental firms, proof of first rental is also required.

What your warranty *does not* cover:

- Customer instruction. (Your Owner's Manual describes how to install, adjust, and operate your unit. Any additional information should be obtained from your dealer.)
- Installation and related adjustments.
- Signal reception problems not caused by your unit.
- Damage from misuse or neglect.
- Batteries.
- Images burnt onto the screen.
- A unit that has been modified or incorporated into other products.
- A unit purchased or serviced outside the U.S.A.
- Acts of nature, such as but not limited to lightning damage.

Other Information

Product registration:

- Please complete and mail the Product Registration Card packed with your unit. It will make it easier to contact you should it ever be necessary. The return of the card is not required for warranty coverage.

Limitation of Warranty:

- **THE WARRANTY STATED ABOVE IS THE ONLY WARRANTY APPLICABLE TO THIS PRODUCT. ALL OTHER WARRANTIES, EXPRESS OR IMPLIED (INCLUDING ALL IMPLIED WARRANTIES OF MERCHANTABILITY OR FITNESS FOR A PARTICULAR PURPOSE) ARE HEREBY DISCLAIMED. NO VERBAL OR WRITTEN INFORMATION GIVEN BY THOMSON MULTIMEDIA INC., ITS AGENTS OR EMPLOYEES SHALL CREATE A WARRANTY OR IN ANY WAY INCREASE THE SCOPE OF THIS WARRANTY.**
- **REPAIR OR REPLACEMENT AS PROVIDED UNDER THIS WARRANTY IS THE EXCLUSIVE REMEDY OF THE CONSUMER. THOMSON MULTIMEDIA INC. SHALL NOT BE LIABLE FOR INCIDENTAL OR CONSEQUENTIAL DAMAGES RESULTING FROM THE USE OF THIS PRODUCT OR ARISING OUT OF ANY BREACH OF ANY EXPRESS OR IMPLIED WARRANTY ON THIS PRODUCT. THIS DISCLAIMER OF WARRANTIES AND LIMITED WARRANTY ARE GOVERNED BY THE LAWS OF THE STATE OF INDIANA. EXCEPT TO THE EXTENT PROHIBITED BY APPLICABLE LAW, ANY IMPLIED WARRANTY OF MERCHANTABILITY OR FITNESS FOR A PARTICULAR PURPOSE ON THIS PRODUCT IS LIMITED TO THE APPLICABLE WARRANTY PERIOD SET FORTH ABOVE.**

How State Law relates to this warranty:

- Some states do not allow the exclusion nor limitation of incidental or consequential damages, or limitations on how long an implied warranty lasts, so the above limitations or exclusions may not apply to you.
- This warranty gives you specific legal rights, and you also may have other rights that vary from state to state.

If you purchased your television outside the United States:

- This warranty does not apply. Contact your dealer for warranty information.

Service calls which do not involve defective materials or workmanship are not covered by this warranty. Costs of such service calls are the sole responsibility of the purchaser.

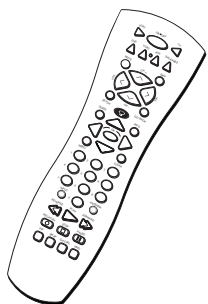

CRK76TVL1

Remote Control This is the remote control that came packed with your TV. Replacements or spares can be ordered as needed.

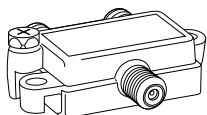

Splitter
VH47

2-way Signal Splitter helps you connect to a second TV or VCR.



ANT200

Amplified VHF/UHF/FM Antenna allows you to easily switch from the antenna signal to cable or satellite easily without disconnecting antenna.

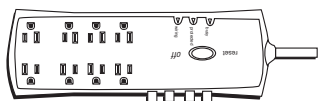

SCTV 160

Surge Protector provides eight outlets, coaxial and telephone line protection. Audible alarm for surge failure.

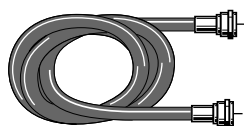

VH81 (3-ft)
VH82 (6-ft)

Screw-on Cable attaches to the round antenna connectors (called 75-ohm F-type) on the back of your VCR or TV. The ends screw onto the connectors for a secure connection.



VH83

Standard Audio/Video cable with RCA-type phono plugs.



VH913

S-Video Cable has multi-pin connectors on each end for connecting S-Video components to your TV.

Accessory Order Form

Description	Part No.	Price	Qty	Total
Screw-on antenna cable (3-ft)	VH81	\$3.95		
Screw-on antenna cable (6-ft)	VH82	\$4.95		
Push-on antenna cable (6-ft)	VH89	\$5.95		
Monaural VCR Dubbing Cable (6-ft)	VH83	\$5.95		
Stereo VCR Dubbing Cable (6-ft)	VH84	\$9.95		
S-Video Cable (6-ft)	VH976	\$7.95		
S-Video Cable (12-ft)	VH913	\$14.95		
2-way Signal Splitter	VH47	\$3.95		
Amplified Antenna	ANT200	\$49.95		
Remote Control (CRK76TVL1)	252105	\$29.20		
Audio•Video Adapter	228449	\$4.45		
Surge Protector	SCTV160	\$49.95		

Prices are subject to change without notice.

Total Merchandise \$ _____

Sales Tax \$ _____

We are required by law to collect the appropriate sales tax for each individual state, country, and locality to which the merchandise is being sent.

Shipping and Handling \$ 5.00

Total Amount Enclosed \$ _____

Use VISA, MasterCard, or Discover Card preferably.

Money order or check must be in U.S. currency only.

No COD or CASH.



Detach Here

All accessories are subject to availability. Where applicable, we will ship a superseding model.

Please complete other side also

Other Information

Charge your order on your VISA, MasterCard, or Discover Card by filling in below

USE YOUR CREDIT CARD

IMPORTANT: Copy complete account number from your VISA card



My card expires:

IMPORTANT: Copy complete account number from your MasterCard



Copy Number above your name on MasterCard

My card expires:

IMPORTANT: Copy complete account number from your Discover Card



My card expires:

AUTHORIZED SIGNATURE

(Credit card order will not be processed without signature)

Print or type your name and address clearly.



A complete and correct order will save you days of waiting.

Name: _____

Street: _____

_____ Apt: _____

City: _____

State: _____ Zip: _____

Daytime phone number: _____

Please make sure that both sides of this form have been filled out completely.

- Allow 4 weeks for delivery.
- All accessories are subject to availability.
- Prices are subject to change.

Placing an Order

To place your order by phone, have your Visa, MasterCard or Discover Card ready and call the toll-free number listed below.

Use this number only to place an order for accessory items listed on this order form.

1-800-338-0376

To place your order by mail, detach and mail the completed order form with credit card information, money order or check in US currency (made payable to Thomson multimedia Inc.) to the following address:

**Video Accessories
PO Box 8419
Ronks, PA 17573**

This page left intentionally blank.

This page left intentionally blank.

This page left intentionally blank.

This page left intentionally blank.

This page left intentionally blank.

Symbols

16:9 Mode 2, 57

A

Accessory Order Form 67
Adjust Projection TV 56
Age-Based Ratings 47
Anamorphic Mode (16:9) 57
ANTENNA Button 26
Audio
 Menu 54
 Output 14
 Processor 54
Audio Menu
 Sound Logic Stereo 55
 Speakers 55
 Tone Controls 54
 Second Audio Program 55
Audio/video cables 7, 13
Audio/video jacks 13
Auto
 Channel Search 18, 58
 Color 55
 Converge 56
 Tuning 58
Automatic Code Search 28
Automatic Convergence 56
Autotuning 2, 43
 DVD Channel 43
 Front Input 44
 High Resolution Input 44
 SAT/CABLE Channel 43
 VCR Channels 43
AUX Button 26

B

Batteries 17
Black Level 55
Block
 Age-Based Ratings 47
 Front Panel 51
 Movie Ratings 50
 Specific Content Themes 48
 V-Chip Unrated Program 51

Blue Convergence 56
Buttons
 Front Panel 16
 Remote 26

C

Cables 13
 Audio/Video 7
 audio/video 13
 coaxial 7, 14
 COMPONENT VIDEO 13
 for RF jacks 14
 for Y, Pb, Pr jacks 13
 G-LINK 7
 S-Video 7, 13
Care and Cleaning 61
CH CTRL 26, 52
Channel
 3 44
 Banner 41, 42
 Block 51
 Labels 58
 Lineup 35
 Menu 58
 Search 18
Choose Your Connection 7
CLEAR Button 26
Closed Caption
 Display 56
 Mode 56, 57
 PIP Display 56
 PIP Mode 56
Coaxial cable 7
Color Warmth 55
Component Video 13
Component Video cables 7
Composite video 13
Connecting Optional Components
 A/V Receiver + Speakers 12
 HD Receiver + VCR + DVD Player 8
 TV+DVD+VCR 11
 TV+Satellite Receiver+VCR 10
Content Themes 47
Contrast 55

D

DVD
 Button 26
 Channel 43

E

Editor Menu 40
EXT/INT Switch 14
External Speakers 14

F

Finding the sensor 15
Fixed Output 12, 14
Front Panel
 Buttons 16
 Inputs 16
Front panel
 Block 51

G

G-LINK
 cable 7
 connecting 15
GO BACK Button 26
Green Image 56
Grid Guide menu 35
GUIDE Button 26
GUIDE Plus+ system
 Channel Lineup 35
 Channels 41
 Downloading Information 34
 Setup 19
Guide Plus+ system 19, 23

H

High Resolution Input Jacks and Cables 14

I

INFO Button 26
INPUT1 44
INPUT1 jacks 13
INPUT2 jacks 13
INPUT3 jacks 13
INT Switch 14
Interactive setup 18

J

Jacks 13
 audio/video 13
 COMPONENT VIDEO 13
 RF 14
 S-VIDEO 13
 SATELLITE IN 14

K

Key Features Overview
1

L

Labels 58
Language 56
Languages, selecting 18
Limited Warranty 65
Locating remote sensor
15
Lock, Parental Controls
51

M

Memory 58
Menu
Audio 54
Channel 58
Editor 40
Grid Guide 35
Messages 39
News 38
Picture Quality 55
Schedule 38
Setup 40
Sort 37
Time 58
Menu Background Color
56
MENU Button 26
Menu Language 56
Menus 54
GUIDE Plus+ System
setup 19
Messages menu 39
Modes, remote control
30
Mono 54
Mute 27, 54, 56

N

News menu 38
Normal List 58

O

OK Button 27
ON•OFF Button 26
On-screen Program Guide 1
Order form 67

P

Parental Controls
Locking, Unlocking 51
menu 45
Picture
Presets 55
Quality Menu 55
PIP (Picture in Picture) 52
Buttons 52
Closed caption display 56
Closed caption mode 56
PIP Button 27
POWER on Front Panel 16
Programming the Remote
Automatic Code Search 28
Direct Entry 29

R

Rating Limits
movies 50
TV 46
RCA-type cables 13
Red Convergence 56
Remote
component buttons 28
sensor 15
Remote Control
Buttons 26
Installing the Batteries 17
Programming 28
Programming Codes 31
RF jacks 14

S

S-VIDEO 13
cable 7
SAT/Cable Channel 43
SATELLITE IN jack 14
Satellite receiver codes 32
Schedule
menu 38

time 58

Screen Menu 56
Second Audio Program
(SAP) 55

Set

DVD Channel 43
SAT/CABLE Channel
43
Time 58
VCR1 Channel 43
VCR2 Channel 43

Setup

GUIDE Plus+ system
menus 19
menu 40

Sharpness 55

Signal Type

Cable TV 58
UHF/VHF Antenna 58

SKIP Button 27

Sleep Timer 42, 58

Sort menu 37

Specifications 63

SRS Stereo (•) Focus
55

Stereo 54

SWAP Button 27, 52

T

Things to Consider
Before You
Connect 6

Time

Current 42
Menu 58

Tint 55

Tone Controls 54

Troubleshooting 60

TV Button 27

U

UHF/VHF Antenna 58
Universal remote
programming to
control other brands
of components 30
Unlock, Parental
Controls 51

Index

V

- V-Chip 45
 - Age-Based Ratings 45
 - Blocking Movies 50
 - Content Themes 45
- V-Chip: Parental Controls 1
- Variable Output 12, 14
- VCR
 - 1 Channel 43
 - 2 Channel 43
- VCR1 Button 27
- VCR2 Button 27

W

- Warranty 65

Y

- Y Pb Pr jacks 13

This page left intentionally blank.

Visit the RCA website at www.rca.com

Please do not send any products to the Indianapolis address listed in this manual or on the carton. This will only add delays in service for your product.

**Thomson multimedia Inc.
10330 North Meridian Street
Indianapolis, IN 46290**

©2001 Thomson multimedia Inc.
Trademark(s)® Registered
Marca(s) Registrada(s)
Printed in USA
TOCOM 15758590 Rev 1

