

15" LCD Television

FLM-1514, FLM-1514B, FLM-153B, FLM-1517



Your LCD TV may look slightly different from the one pictured above.

Table Of Contents

Important Safety Instructions	1
Product Features	3
Front Panel	4
Rear Panel	5
Remote Control	6
System Connections	8
Connecting to External AV Signal Source	8
Connecting to External AV Signal Source (Component)	10
Connecting to PC	11
Connecting to Power Cable	12
Connecting to TV Signal	13
Connecting to Headphones	15
TV Functions	14
Preparations	14
Image Setting	14
Audio Setting	15
Sleep Setting	16
Parental Setting	17
Setup Setting	20
Other Functions	23
External AV Input Function	23
Computer Screen Function	23
Troubleshooting	24
Specifications	25

Important Safety Instructions

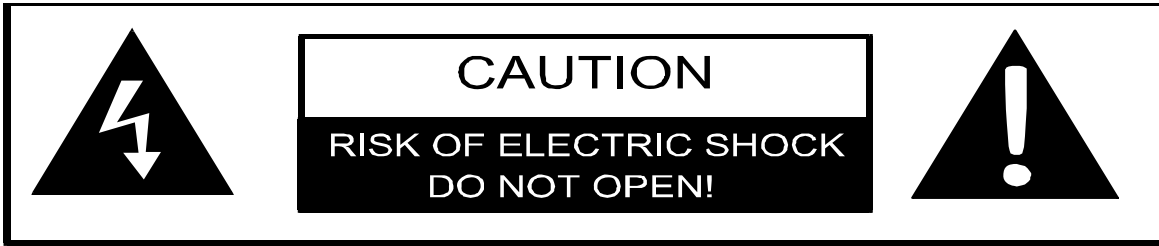

The lightning flash with arrowhead symbol, within an equilateral triangle, is intended to alert the user to the presence of un-insulated “dangerous voltage” within the product’s enclosure that may be of sufficient magnitude to constitute a risk of electric to persons.



The exclamation point within an equilateral triangle is intended to alert the user to the presence of important operating and maintenance (servicing) instructions in the literature accompanying the appliance.

POWER SUPPLY:

Plug the two-prong end of the power cord to an AC100-240V outlet. If you have difficulty inserting the plug, turn it over and reinsert it. If the unit will not be used for a long time, disconnect the plug from the outlet.

NOTE:

Before plugging the power cord into an AC outlet, make sure that all the connections have been made.

CAUTION: These servicing instructions are for use by qualified service personnel only. Don’t perform any servicing other than that contained in the operating instructions unless you are qualified to do so. Refer to service manual for servicing instructions.

Important Safety Instructions

Note:

1. Read these instructions.
2. Keep these instructions.
3. Heed all warnings.
4. Follow all instructions.
5. Do not use near water.
6. Clean only with dry cloth.
7. Do not block any ventilation openings. Maintain well ventilated conditions around the product. Do not put product on bed, sofa or anything that blocks ventilation. Install in accordance with the manufacturer's instructions.
8. Do not install near any heat sources such as radiators, heat registers, stoves, or other apparatus (including amplifiers) that produce heat.
9. Do not defeat the safety purpose of the polarized or grounding-type plug. A polarized plug has two blades with one wider than the other. If the provided plug does not fit into your outlet, consult an electrician for replacement of the obsolete outlet.
10. Protect the power cord from being walked on or pinched particularly at plugs, convenience receptacles, and the point where they exit from the apparatus.
11. Only use attachments/accessories specified by the manufacturer.
12. Use only with the cart, stand, tripod, bracket, or table specified by the manufacturer, or sold with the apparatus. When a cart is used, use caution when moving the cart/apparatus combination to avoid injury from tip-over.
13. Unplug this apparatus during lightning storms or when unused for long periods of time.
14. Refer all servicing to qualified service personnel. Servicing is required when the apparatus has been damaged in any way, such as power-supply cord or plug is damaged, liquid has been spilled or objects have fallen into the apparatus, the apparatus has been exposed to rain or moisture, does not operate normally, or has been dropped.
15. Apparatus shall not be exposed to dripping or splashing and no objects filled with liquids, such as vases, shall be placed on the apparatus.



Note: Do not touch the color TFT LCD screen by hand directly.

Copyright Protection

This product incorporates copyright protection technology that is protected by U.S. patents and other intellectual property rights. Use of this copyright protection technology must be authorized by Macrovision, and is intended for home and other limited viewing uses only unless otherwise authorized by Macrovision. Reverse engineering or disassembly is prohibited.

Product Features

This product incorporates LCD display and TV receiver in one system.

Multiple Mode

Component mode

VGA mode

TV mode

Composite mode

S-VIDEO mode

Special Function

Support sleep time setting function.

Multi-audio and Multi-video modes

Support multi-audio and multi-video modes, provide more selecting.

High Quality Property

LCD (Liquid Crystal Display)

Designed with 15" color TFT liquid crystal display clearly shows the data.

Auto TV Searching Function

Can be connected to the TV antenna, support Auto TV programs searching function.

Stereo amplifier

Built-in 2x3w stereo speakers provide high quality sound.

NOTE: It is normal for a TFT screen to experience some light or dark spots appearing on the LCD screen.

AV and VGA Input

Can be connected external audio and video signal source and PC.

Front Panel

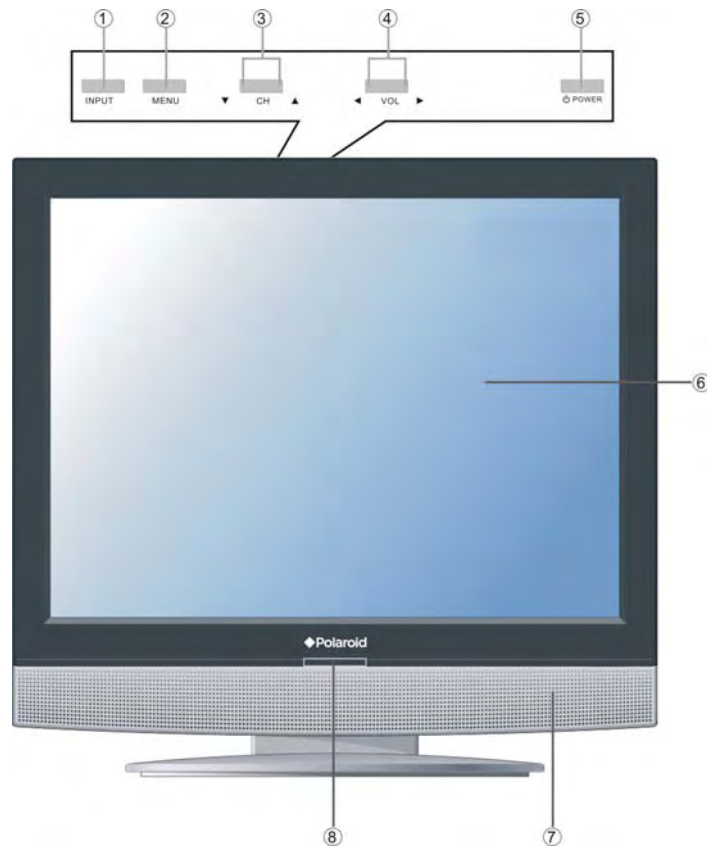

- 1. INPUT button**
Press to select the modes: Component, VGA, TV, Composite or S-VIDEO.
- 2. MENU button**
Press to enter or exit setup menu.
- 3. CH ▲/▼ button**
In the TV mode, press to select channels.
In setup menu, the same function as ▲/▼ direction buttons.
- 4. VOL ◀/▶ button**
In the TV mode, press to decrease or increase the volume.
In setup menu, the same function as ◀/▶ direction buttons.
- 5. POWER button**
Press to enter or exit the standby mode.
- 6. 15" color TFT screen**
15" color TFT screen clearly show the data.
- 7. Speaker**
Output high quality stereo sound.
- 8. Remote Sensor**
Remote sensor window for the remote control.

Rear Panel

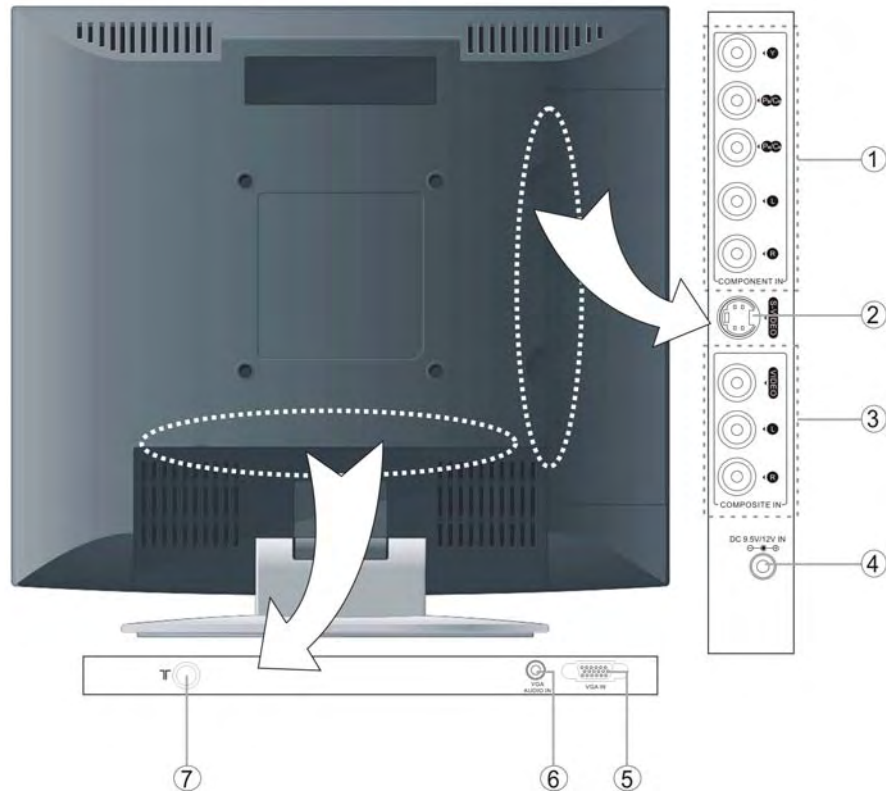

- 1. Component Input / L/R Audio Input Jack**
Connected to the Component (YPbPr) input in Component mode.
Connected to the L/R audio input in Component mode.
- 2. S-VIDEO Input Jacks**
- 3. VIDEO/L/R Audio Input Jack**
Connected to the VIDEO input in Composite mode.
Connected to the L/R audio input in Composite mode.
- 4. DC 9.5V/12V In Jack**
Connected to power adapter.

- 5. VGA Input Jack**
Connected to the VGA output jack on a personal computer.
- 6. PC AUDIO Input Jack**
Connected to the PC audio output jack.
- 7. TV Signal Input Jack**
Connected for the external NTSC TV signal input.

Remote Control

Remote Control Drawing

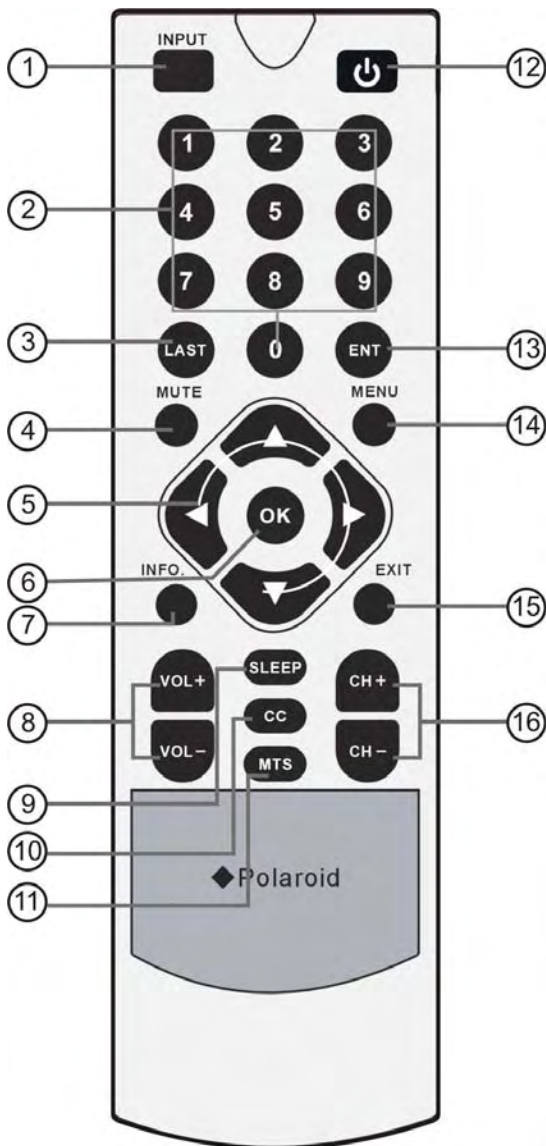

- 1. INPUT button**
Press to select the modes: Component, VGA, TV, Composite or S-VIDEO.
- 2. 0~9 Number buttons**
Press to select numbers.
- 3. LAST button**
In the TV mode, press to return to the channel last viewed.
- 4. MUTE button**
Press to turn on or off the speaker output.
- 5. Direction buttons (▲▼◀▶)**
In the setup menu, press the ▲▼ button to select the desired item and press the ◀▶ button to adjust or set.
- 6. OK button**
Press to confirm your selection.
- 7. INFO button**
Press to display the information about current status on the screen.
- 8. VOL +/- button**
Press to increase or decrease the volume.
- 9. SLEEP button**
Press to select sleep time.
- 10. CC button**
In the TV or CVBS mode, press to display the closed captions or cancel display.
- 11. MTS button**
Press to activate MTS function in TV mode.
- 12. POWER button**
Press to enter or exit the standby mode.
- 13. ENT button**
Under TV mode, confirm the selected TV channel during TV channel selection.
- 14. MENU button**
Press to enter the LCD setup menu.
- 15. EXIT button**
Press to exit the setup menu.
- 16. CH +/- button**
In TV mode, press to select channel.

Remote Control

Preparation of Remote Control

Softly push the back cover to open the battery compartment.

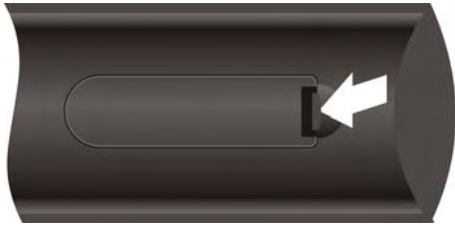

Insert two batteries (1.5V, size AAA) into the compartment, please make sure the polarity matches the marks inside the compartment.

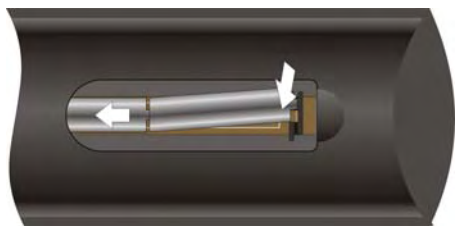

Softly press the back cover to close it.

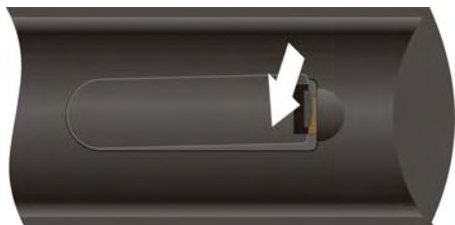

- Under normal use the battery will last for six months.
- Take out the battery when the remote is not in use for a long time.

Using of Remote control

Point the remote control unit from no more than about 7m from the remote control sensor and within about 60 degrees of the front of the unit.



- The operating distance may vary depending to the brightness around.

Notes:

- Do not point bright lights directly at the remote control sensor.
- Do not place objects between the remote control unit and the remote control sensor.
- Do not use this remote control unit while simultaneously operating the remote control unit of any other equipment.

System Connections

- Do not connect the power cord until all other connections have been made.
- Ensure that you observe the color cord when connecting audio and video cables.

Connecting to External AV Signal Source

Use the audio and video cable to connect the AV input jacks on the rear panel of the unit to the external AV signal source.

After connection, turn on the power of the unit and the external AV signal source and then press the INPUT button to shift to Composite mode.

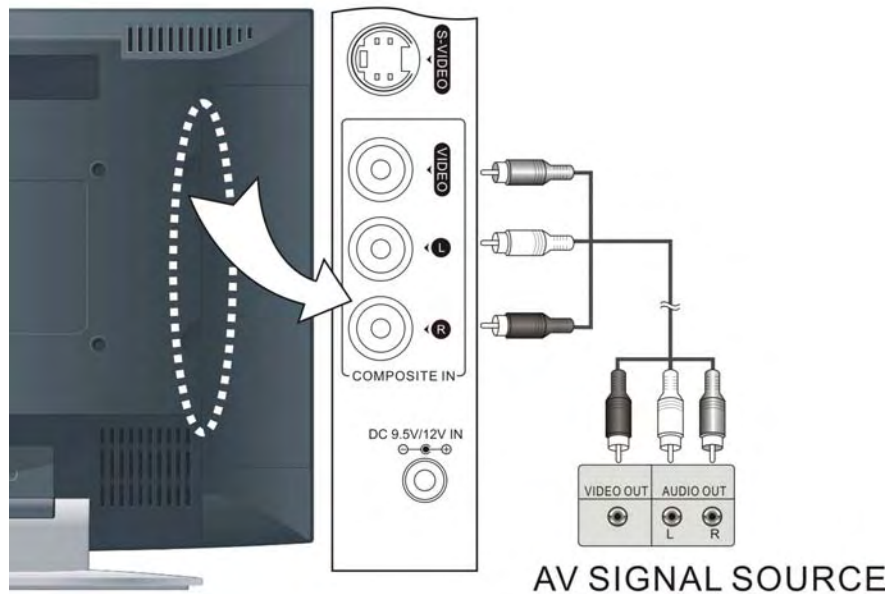

System Connections

Connecting to External AV Signal Source

Use the audio cable to connect the audio input jacks on the rear panel of the unit to the external AV signal source.

Use the S-VIDEO cable to connect the S-VIDEO input jack on the rear panel of the unit to the external AV signal source.

After connection, turn on the power of the unit and the external AV signal source and then press the INPUT button to shift to S-VIDEO mode.

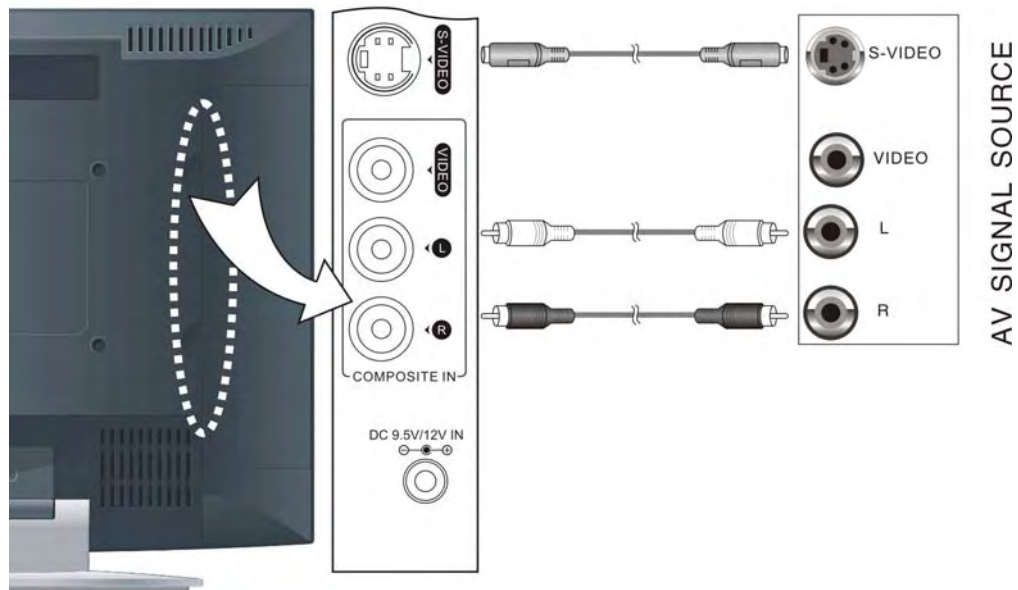

System Connections

Connecting to External AV Signal Source (COMPONENT)

Use the audio and video cables to connect the COMPONENT (Y/Pb/Pr) input Jacks on the rear panel of the unit to the external AV signal source.

After connection, turn on the power of the unit and external AV signal source and then press the INPUT button to shift to Component mode.

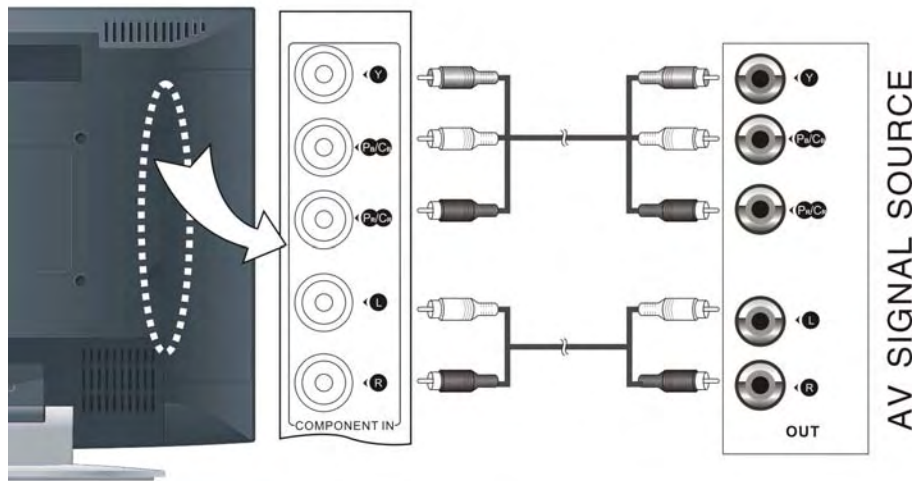

System Connections

Connecting to PC

The unit can be connected to PC (person computer) via the VGA cable. Follow the steps and the figure below to connect:

1. Connect one end of the VGA cable to the VGA input jack on the rear panel of the unit.
2. Connect the other end to the PC.
3. Connect one end of the audio cable to the PC audio input jack on the rear panel of the unit.
4. Connect the other end to the PC audio output jack.
5. Please set the PC's resolution at 1024x768@60Hz

After connection, turn on the unit and the PC and then press the INPUT button to shift to VGA mode.

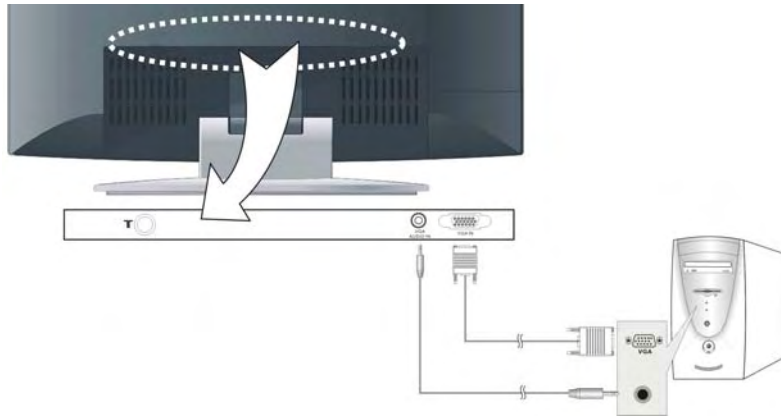

System Connections

Connecting the Power Cable

Plug the two-prong end of the power cord to an AC100-240V outlet. If you have difficulty inserting the plug, turn it over and reinsert it. If the unit will not be used for a long time, disconnect the plug from the outlet.

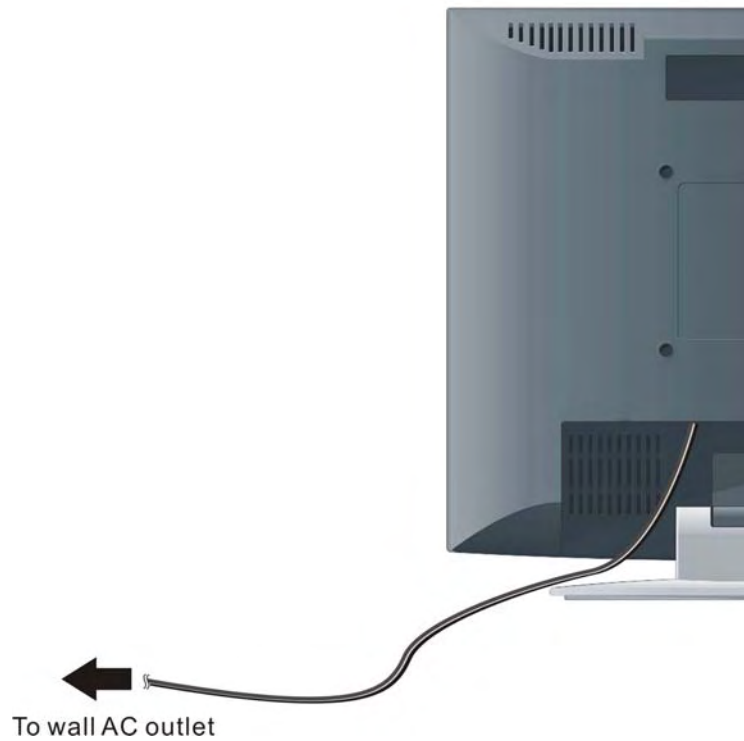

System Connections

Connecting to TV Signal

This unit can be connected to the TV signal input source via the TV jack on the rear panel.

After connection, turn on the power of the unit, press the INPUT button to shift to TV mode.

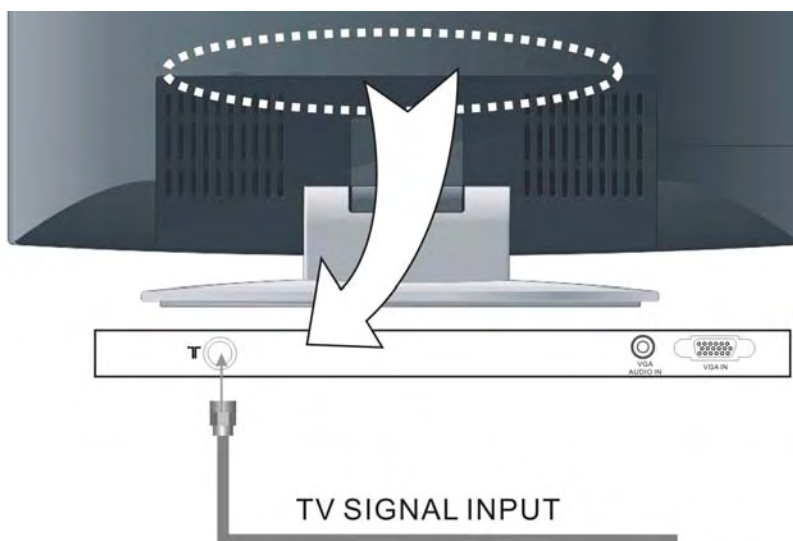

After connecting to the antenna, turn on the unit, and go on with program searching, you can follow the below steps to select channels:

1. For 0~9 channel:
Press the number buttons to select the channel X, wait two seconds and it will go to the selected channel.
Or press the number buttons to input 00X, it will go to the selected channel immediately.
2. For 10~99 channel:
Press the number buttons to select channel XX, wait two seconds and it will go to the selected channel.
3. For 100~125 channels:
Press the number buttons to select channels XXX, and it will go to the selected channel.

* X is the channel number.

When the unit is connected with CATV cable, after selecting the TV channel number including one or two number, press the ENT button to confirm, after selecting the TV channel number (refer to three number), don't need to press the ENT button to confirm. When the unit is connected with external antenna, after selecting the TV channel number (refer to one number), press the ENT button to confirm. after selecting the TV channel number (refer to two number), don't need to press the ENT button to confirm.

TV Function

Preparations

1. After connection, press the POWER button to turn on the power.
2. Press the INPUT button to shift to TV mode. You can go on with the following operations:

Image Setting

Note: This item is only available when there is signal input.

Press the MENU button once to enter the setup menu, as shown on the right:

In the setup menu, press the ▲▼ button to select **Image** and then press the OK button to enter the item. Press the ▲▼ button to select. Press the MENU button to return to the previous menu.

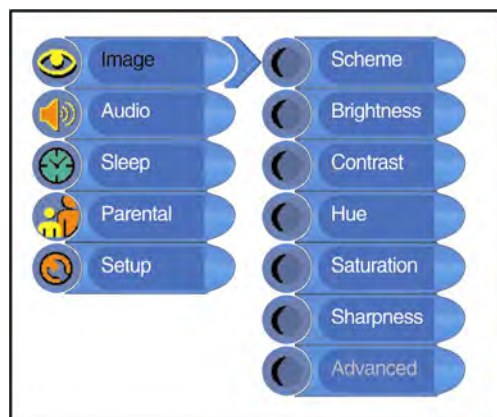

Scheme Setup

Press the ▲▼ button to select **Scheme** and press the OK button to enter. Press the ▲▼ button to select the desired item and press the OK button to confirm your selection. Press the MENU button to return to the previous menu.

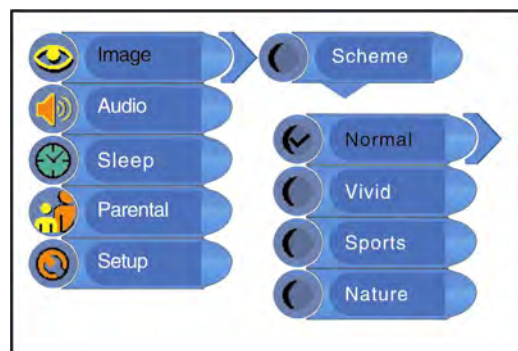

Brightness Setup

Press the ▲▼ button to select **Brightness** and press the ◀▶ button to adjust the value. Press the MENU button to return to the previous menu.

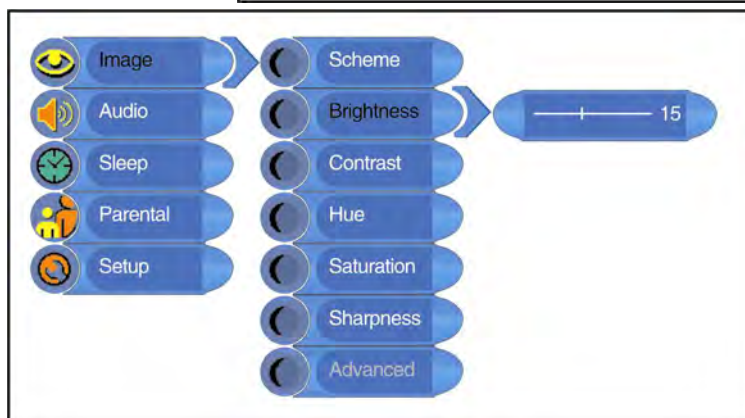

TV Function

Contrast Setup

Press the ▲▼ button to select **Contrast** and press the ◀▶ button to adjust the value. Press the MENU button to return to the previous menu.

Hue Setup

Press the ▲▼ button to select **Hue** and press the ◀▶ button to adjust the value. Press the MENU button to return to the previous menu.

Saturation Setup

Press the ▲▼ button to select **Saturation** and press the ◀▶ button to adjust the value. Press the MENU button to return to the previous menu.

Sharpness Setup

Press the ▲▼ button to select **Sharpness** and press the ◀▶ button to adjust the value. Press the MENU button to return to the previous menu.

Advanced Setup

Press the ▲▼ button to select **Advanced** and press the OK button to enter.

In the menu, press the ▲▼ button to select the desired item and then press the OK button to confirm. Press the MENU button to return to the previous menu.

Note: This item is only available in Component and VGA modes.

Audio Setting

Press the MENU button once to enter the setup menu. Press the ▲▼ button to select **Audio** and press the OK button to enter the menu shown on the right.

In the **Audio** setup menu, press the ▲▼ button to select the desired item and press the OK button to enter. Press the MENU button to return to the previous menu.

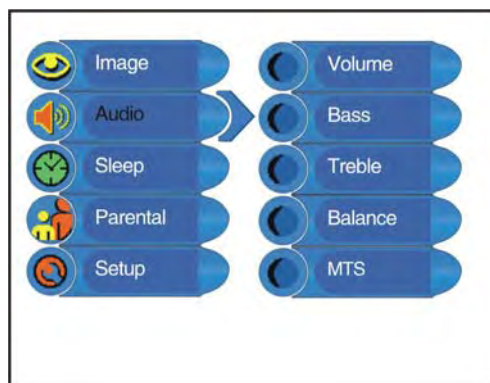

Volume Setup

Press the ▲▼ button to select **Volume** and press the ◀▶ button to adjust the level. Press the MENU button to return to the previous menu.

Bass Setup

Press the ▲▼ button to select **Bass** and press the ◀▶ button to adjust the level. Press the MENU button to return to the previous menu.

TV Function

Treble Setup

Press the ▲▼ button to select **Treble** and press the ◀▶ button to adjust the level. Press the MENU button to return to the previous menu.

Balance Setup

Press the ▲▼ button to select **Balance** and press the ◀▶ button to adjust the level. Press the MENU button to return to the previous menu.

MTS Setup

Press the ▲▼ button to select **MTS** and press the OK button to enter. Press the ▲▼ button to select the desired item and then press the OK button to confirm your selection. Press the MENU button to return to the previous menu.

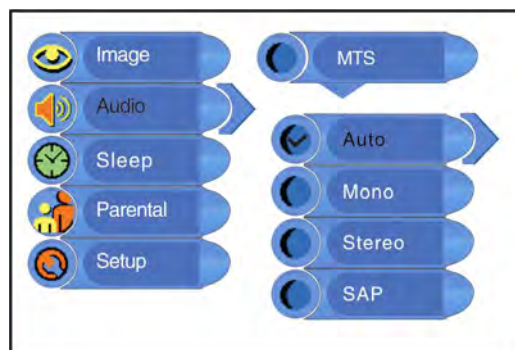

Sleep Setting

Press the MENU button to enter the setup menu. Press the ▲▼ button to select **Sleep** and press the OK button to enter the menu shown on the right.

In the **Sleep** setup menu, press the ▲▼ button to select 15Min, 30Min, 45Min, 60Min, 75Min, 90Min, 105Min, 120Min or Off. Press the MENU button to return to the previous menu.

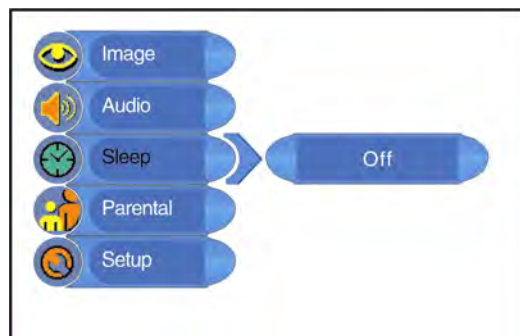

TV Function

Parental Setting

Note: The Parental Function is the same as that of V-CHIP.

Press the MENU button to enter the setup menu. Press the ▲▼ button to select **Parental** and press the OK button to enter the menu shown on the right.

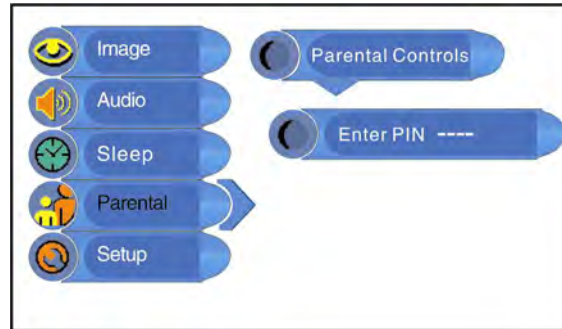

In the **Parental** setup menu, press the OK button and then use the number buttons to enter the pin. The default pin is 1111. Then press the OK button to continue and display the menu as shown on the right.

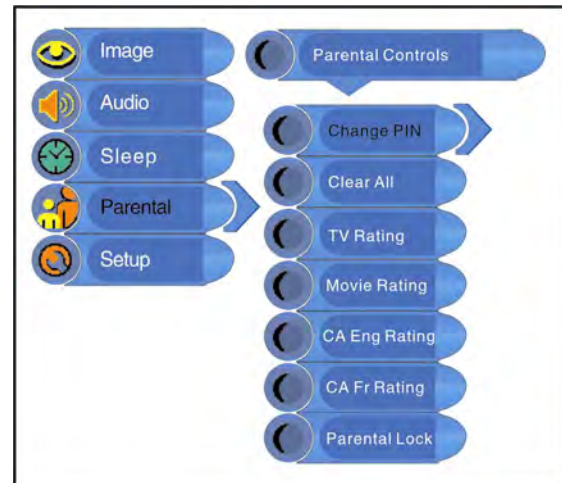

Change PIN

Press the ▲▼ button to select **Change PIN** and press the OK button to enter. Use the number buttons to enter the new pin you want and then press the OK button to confirm. Then use the number buttons to enter the new pin again and press the OK button to confirm and return to the previous menu.

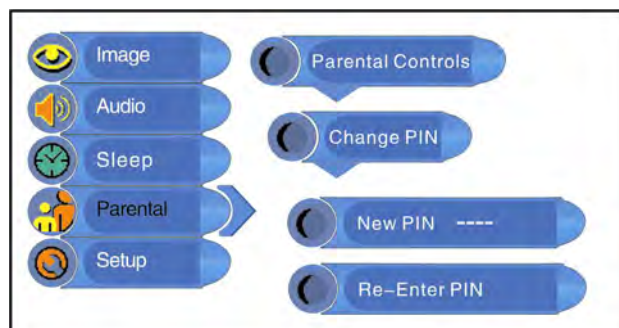

TV Function

Clear All

Press the ▲▼ button to select **Clear All** and press the OK button to enter. Press the ▲▼ button to select the desired item and then press the OK button to confirm your selection. Press the MENU button to return to the previous menu.

TV Rating

Press the ▲▼ button to select **TV Rating** and press the OK button to enter. Press the ▲▼ button to select the desired item and then press the OK button to confirm your selection. Press the MENU button to return to the previous menu.

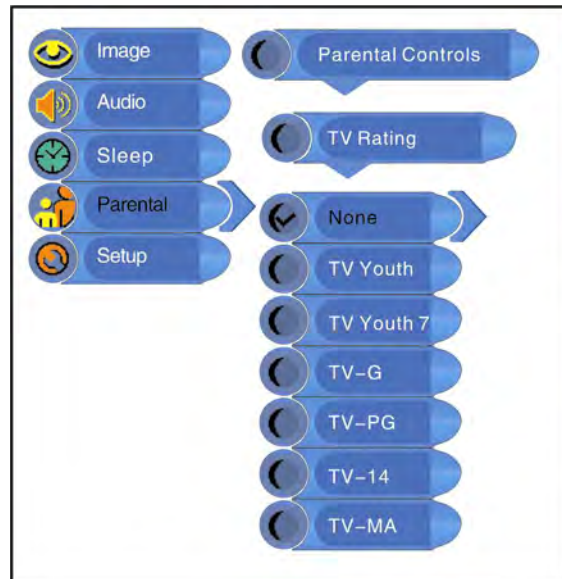

Movie Rating

Press the ▲▼ button to select **Movie Rating** and press the OK button to enter. Press the ▲▼ button to select the desired item and then press the OK button to confirm your selection. Press the MENU button to return to the previous menu.

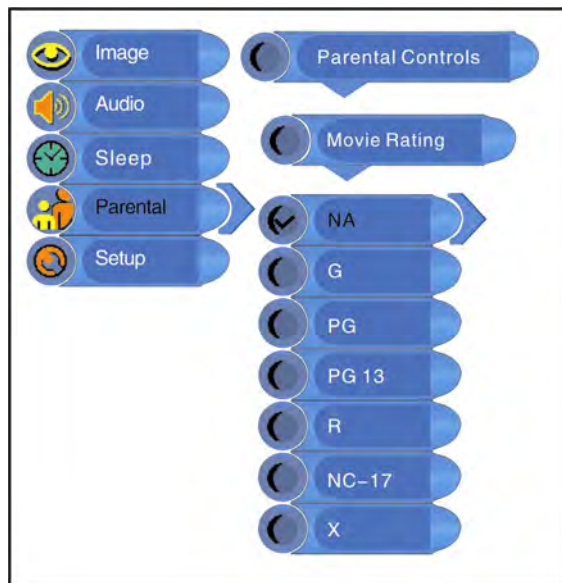

TV Function

CA Eng Rating

Press the ▲▼ button to select **CA Eng Rating** and press the OK button to enter. Press the ▲▼ button to select the desired item and then press the OK button to confirm your selection. Press the MENU button to return to the previous menu.

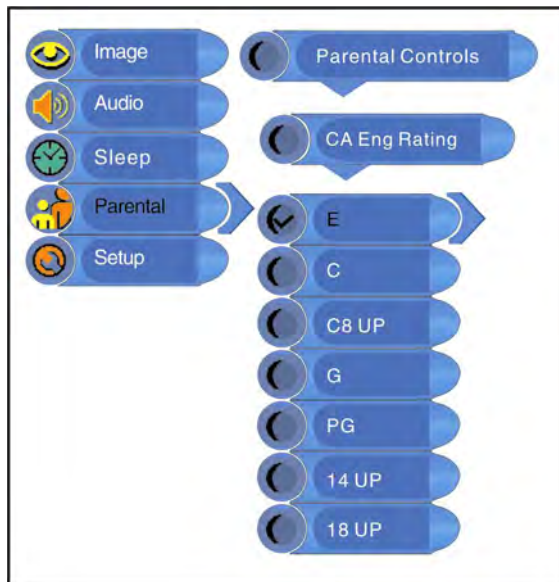

CA Fr Rating

Press the ▲▼ button to select **CA Fr Rating** and press the OK button to enter. Press the ▲▼ button to select the desired item and then press the OK button to confirm your selection. Press the MENU button to return to the previous menu.

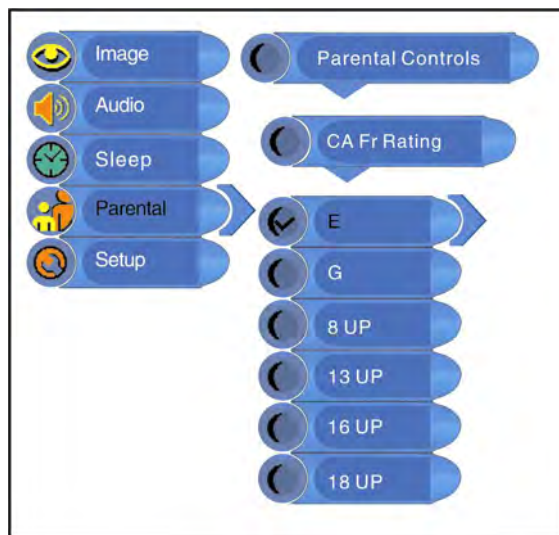

Parental Lock

Press the ▲▼ button to select **Parental Lock** and press the OK button to enter. Press the ▲▼ button to select the desired item and then press the OK button to confirm your selection. Press the MENU button to return to the previous menu.

TV Function

Setup Setting

Press the MENU button once to enter the setup menu. Press the ▲▼ button to select **Setup** and press the OK button to enter the menu shown on the right.

In the **Setup** menu, press the ▲▼ button to select the desired item and press the OK button to enter. Press the MENU button to return to the previous menu.

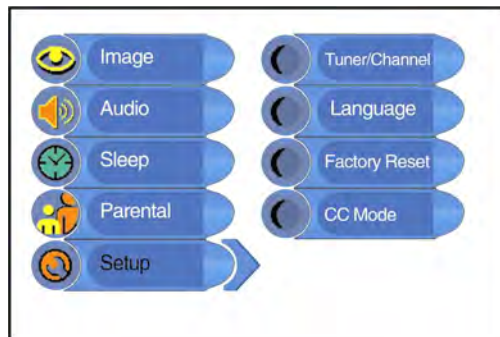

Tuner/Channel

Press the ▲▼ button to select the **Tuner/Channel** and press the OK button to enter the menu as shown on the right. Press the ▲▼ button to select the desired item and press the OK button to enter. Press the MENU button to return to the previous menu.

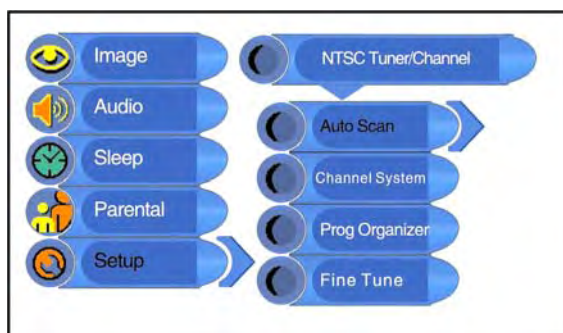

Auto Scan

Press the ▲▼ button to select the **Auto Scan**, press the OK button to start auto scan. The screen will display as below:



Auto scan will take a few minutes, when the tuning operation completes the unit will exit and memorize the programs by sequence automatically.

During tuning, press the MENU button to exit the auto scan mode.

TV Function

Channel System

Press the ▲▼ button to select **Channel System** and press the OK button to enter. Press the ▲▼ button to select the desired item and then press the OK button to confirm your selection. Press the MENU button to return to the previous menu.

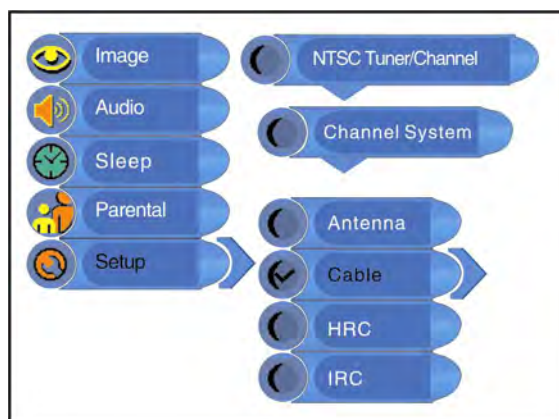

Prog Organizer

Press the ▲▼ button to select the **Prog Organizer** and press the OK button to enter the menu as shown on the right.

In the **Prog Organizer** setup menu, press the ▲▼ button to select the desired item. Press the MENU button to return to the previous menu.

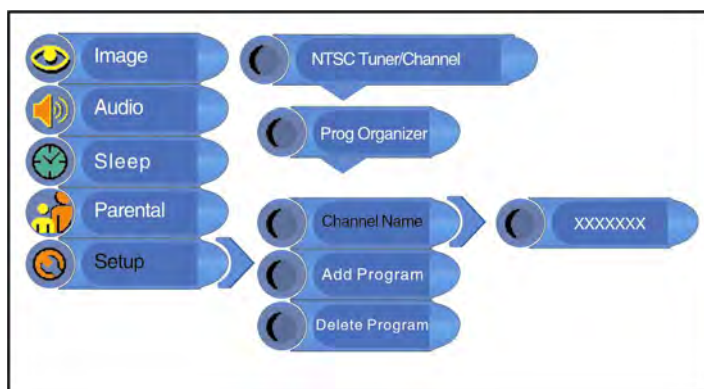

Channel Name

Press the ▲▼ button to select the **Channel Name** and press the OK button to enter. Then press the ▲▼ button to select letters or press the number button to input numbers. Press the MENU button to return to the previous menu.

Add Program

Press the ▲▼ button to select the **Add Program** and press the OK button to cancel the skip function which when using the CH ▲▼ button to select channels under normal playback status, it will play the channels in sequence. Press the MENU button to return to the previous menu.

Delete Program

Press the ▲▼ button to select the **Delete Program** and press the OK button to activate the skip function which when using the CH ▲▼ button to select channels under normal playback status, it will skip the current channel. Press the MENU button to return to the previous menu.

TV Function

Fine Tune

Press the ▲▼ button to select **Fine Tune** and press the OK button to enter. Press the ► or ◀ button to start fine tuning forward or backward. Press the MENU button to return to the previous menu.

Language

Press the ▲▼ button to select the **Language**, press the OK button to enter the setup, press the ▲▼ button to select item. Press the MENU button to return to the previous menu.

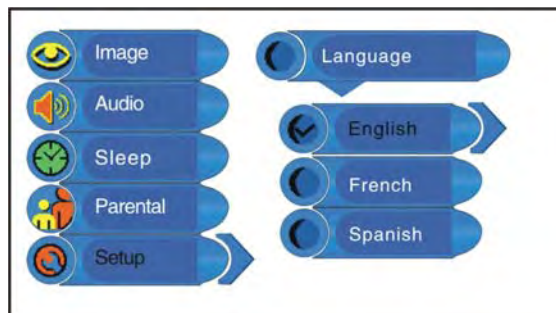

Factory Reset

Press the ▲▼ button to select the **Factory Reset**, press the OK button to resume default status.

CC Mode

Press the ▲▼ button to select **CC Mode** and press the OK button to enter. Press the ▲▼ button to select the desired item and then press the OK button to confirm your selection. Press the MENU button to return to the previous menu.

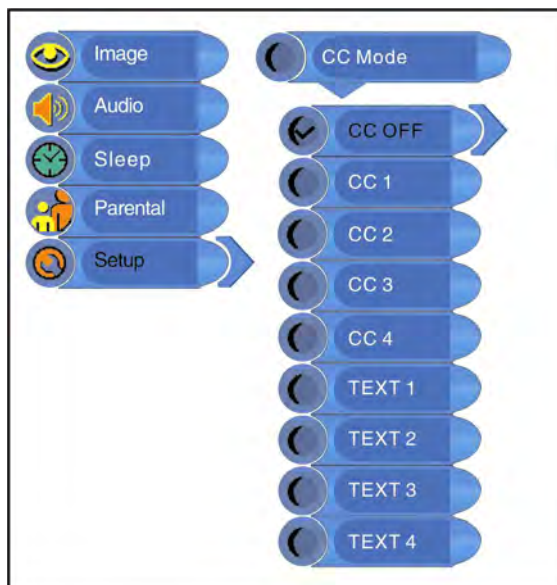

Other Function

External AV Input Function

The unit has external AV input function. It supports S-VIDEO, Composite and Component modes. Use the audio, video and S-Video cable to connect the unit to the external AV signal source such as recorder, vidicon, satellite receiver or game player etc. Then turn on the unit and the external AV signal source. Press the INPUT button to shift to the corresponding mode: S-VIDEO, Composite or Component. Then you can go on to set up the menu in a certain mode.

Computer Screen Function

The TFT LCD screen of the unit can be used as the computer screen. Take the steps of connecting the unit to the PC and then you can set up the menu.

You had better set the PC's resolution at: 1024 x 768@60Hz.

The operations of these menus in S-VIDEO, Composite, Component and VGA modes are the same with those in the TV mode. Please refer to the introduction in “TV Function”.

Note: Some of these menus are not available in these modes.

Troubleshooting

SYMPTOM	CHECK ITEM
There is no sound.	Make sure system connection is correct. Make sure the speakers are not muted. In the TV mode, set the correct sound mode.
LCD does not display a picture.	Make sure the unit is turned on and the connections are correct. Make sure the power adapter is correctly connected.
There is no picture or picture moves up and down.	Check if the connections with the external AV signal source are correct. Correctly set the items in the picture menu. Check if the video type input signal is not corresponding to the unit. Make sure the unit is turned on and in correct video type.
The remote control does not work.	Make sure there are no obstructions between the remote control and the player. Make sure the remote control is pointing at the player. Make sure batteries are inserted and the polarity is correct. Make sure batteries are not weak.

Note about External Interference:

Static or other external interfere may cause the player to behave abnormally. If this occurs, unplug the power-supply cord from the outlet and plug it in again to reset the player. If the problems persist, then please disconnect the power and consult a qualified technician.

Note about Picture Compression:

If two black bars appear on the sides of your LCD screen and your picture is compressed, you may need to adjust the settings of your cable/satellite set-top box. For instructions on adjusting the picture, consult your cable/satellite set-top box's manual or call your local cable/satellite company.

Specifications

TFT-LCD Resolution	1024 x 768
TFT-LCD Screen Size	15 inches
Power	AC100~240V 50/60Hz DC 12V 4A
Power Consumption	< 48W
Dimension	345 x 84 x 390mm (LXWXD)
Weight	About 5.8Kg
Ambient Temperature	10~45 degrees

DESIGN AND SPECIFICATIONS ARE SUBJECT TO CHANGE WITHOUT NOTICE

"Polaroid" and "Polaroid and Pixel" are trademarks of Polaroid Corporation, Waltham, MA, USA.

For service, support and warranty information, visit www.polaroid.com.

