

COVER L9
PR1903C1

Return your Warranty Registration card today to ensure you receive all the benefits you're entitled to.

Once your PHILIPS MAGNAVOX purchase is registered, you're eligible to receive all the privileges of owning a PHILIPS MAGNAVOX product. So complete and return the Warranty Registration Card enclosed with your purchase at once. And take advantage of these important benefits.

Warranty Verification

Registering your product within 10 days confirms your right to maximum protection under the terms and conditions of your PHILIPS MAGNAVOX warranty.

Owner Confirmation

Your completed Warranty Registration Card serves as verification of ownership in the event of product theft or loss.

Model Registration

Returning your Warranty Registration Card right away guarantees you'll receive all the information and special offers which you qualify for as the owner of your model.

Congratulations on your purchase, and welcome to the "family!"

PHILIPS MAGNAVOX



Dear PHILIPS MAGNAVOX product owner:

Thank you for your confidence in PHILIPS MAGNAVOX. You've selected one of the best-built, best-backed products available today. And we'll do everything in our power to keep you happy with your purchase for many years to come.

As a member of the PHILIPS MAGNAVOX "family," you're entitled to protection by one of the most comprehensive warranties and outstanding service networks in the industry.

What's more, your purchase guarantees you'll receive all the information and special offers for which you qualify, plus easy access to accessories from our convenient home shopping network.

And most importantly you can count on our uncompromising commitment to your total satisfaction.

All of this is our way of saying welcome—and thanks for investing in a PHILIPS MAGNAVOX product.

Sincerely,

Robert Minkhorst
President and Chief Executive Officer

P.S. Remember, to get the most from your PHILIPS MAGNAVOX product, you must return your Warranty Registration Card within 10 days. So please mail it to us right now!

Know these
safety symbols



This "bolt of lightning" indicates uninsulated material within your unit may cause an electrical shock. For the safety of everyone in your household, please do not remove product covering.

The "exclamation point" calls attention to features for which you should read the enclosed literature closely to prevent operating and maintenance problems.

WARNING: TO PREVENT FIRE OR SHOCK HAZARD, DO NOT EXPOSE THIS EQUIPMENT TO RAIN OR MOISTURE.

CAUTION: To prevent electric shock, match wide blade of plug to wide slot, and fully insert.

ATTENTION: Pour éviter les chocs électriques, introduire la lame la plus large de la fiche dans la borne correspondante de la prise et pousser jusqu'au fond.

PHILIPS MAGNAVOX Visit our World Wide Web Site at <http://www.philipsmagnavox.com>

SAFETY INSTRUCTIONS - Read before operating equipment

This product was designed and manufactured to meet strict quality and safety standards. There are, however, some installation and operation precautions which you should be particularly aware of.

1. **Read Instructions** - All the safety and operating instructions should be read before the appliance is operated.
2. **Retain Instructions** - The safety and operating instructions should be retained for future reference.
3. **Heed Warnings** - All warnings on the appliance and in the operating instructions should be adhered to.
4. **Follow Instructions** - All operating and use instructions should be followed.
5. **Water and Moisture** - The appliance should not be used near water - for example, near a bathtub, washbowl, kitchen sink, laundry tub, in a wet basement or near a swimming pool, etc.
6. **Carts and Stands** - The appliance should be used only with a cart or stand that is recommended by the manufacturer.
- 6A.  An appliance and cart combination should be moved with care. Quick stops, excessive force, and uneven surfaces may cause the appliance and cart combination to overturn.
- 6B. **Tilt/Stability** - All televisions must comply with recommended international global safety standards for tilt and stability properties of its cabinet design.
 - Do not compromise these design standards by applying excessive pull force to the front, or top, of the cabinet which could ultimately overturn the product.
 - Also, do not endanger yourself, or children, by placing electronic equipment/toys on the top of the cabinet. Such items could unsuspectingly fall from the top of the set and cause product damage and/or personal injury.
7. **Wall or Ceiling Mounting** - The appliance should be mounted to a wall or ceiling only as recommended by the manufacturer.
8. **Ventilation** - The appliance should be situated so that its location or position does not interfere with its proper ventilation. For example, the appliance should not be situated on a bed, sofa, rug, or similar surface that may block the ventilation openings; or, placed in a built-in installation, such as a bookcase or cabinet that may impede the flow of air through the ventilation openings.
9. **Heat** - The appliance should be situated away from heat sources such as radiators, heat registers, stoves, or other appliances (including amplifiers) that produce heat.
10. **Power Sources** - The appliance should be connected to a power supply only of the type described in the operating instructions or as marked on the appliance.

11. **Power-Cord Protection** - Power supply cords should be routed so that they are not likely to be walked on or pinched by items placed upon or against them, paying particular attention to cords and plugs, convenience receptacles, and the point where they exit from the appliance.
12. **Cleaning** - The appliance should be cleaned only as recommended by the manufacturer.
13. **Power Lines** - An outdoor antenna should be located away from power lines.
14. **Outdoor Antenna Grounding** - If an outside antenna is connected to the receiver, be sure the antenna system is grounded so as to provide some protection against voltage surges and built up static charges.

Section 810 of the National Electric Code, ANSI/NFPA No. 70-1984, provides information with respect to proper grounding of the mats and supporting structure grounding of the lead-in wire to an antenna discharge unit, size of grounding connectors, location of antenna-discharge unit, connection to grounding electrodes and requirements for the grounding electrode. See Fig. below.
15. **Non-use Periods** - The power cord of the appliance should be unplugged from the outlet when left unused for a long period of time.
16. **Object and Liquid Entry** - Care should be taken so that objects do not fall and liquids are not spilled into the enclosure through openings.
17. **Damage Requiring Service** - The appliance should be serviced by qualified service personnel when:
 - A. The power supply cord or the plug has been damaged; or
 - B. Objects have fallen, or liquid has been spilled into the appliance; or
 - C. The appliance has been exposed to rain; or
 - D. The appliance does not appear to operate normally or exhibits a marked change in performance; or
 - E. The appliance has been dropped, or the enclosure damaged.
18. **Servicing** - The user should not attempt to service the appliance beyond that described in the operating instructions. All other servicing should be referred to qualified service personnel.

Note to the CATV system installer: This reminder is provided to call the CATV system installer's attention to Article 820-40 of the NEC that provides guidelines for proper grounding and, in particular, specifies that the cable ground shall be connected to the grounding system of the building, as close to the point of cable entry as practical.

Example of Antenna Grounding as per NEC - National Electric Code

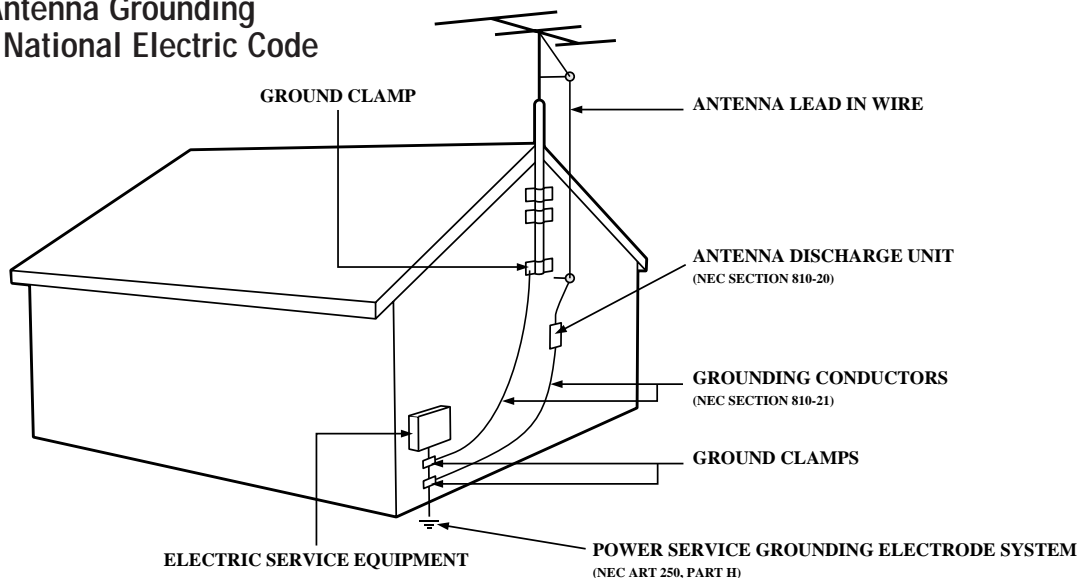

TABLE OF CONTENTS

Introduction

Welcome/Registration of Your TV	2
Safety/Precautions	3
Table of Contents	4
Features	4
Basic Cable TV Hookups	5
Basic Antenna Hookups.....	6
Basic TV to VCR Hookup.....	7
Basic TV and Remote Operations	8
TV Remote Buttons	9



Onscreen MENU

◇ Setting the Language Control	10
◇ Using the Tuner Control.....	11
◇ Using the Auto Program Control	12
◇ How to Add and Delete Channels.....	13
◇ Adjusting the TV Picture	14
◇ Activating Noise Reduction (Picture) Control	15
◇ Setting the TV for Closed Caption	16
◇ Using the Sleep Timer Control	17
◇ Using the Volume Bar Control	18
◇ Using the Alternate Channel.....	19



SmartLock™

◇ Understanding the SmartLock Feature	20
◇ Setting the SmartLock Access Code.....	21
◇ Setting the SmartLock to Block Channels.....	22
◇ Setting SmartLock's Blocking Options	23
◇ Blocking Using the Movie/TV Ratings	24-25
◇ Using the SmartLock Review Screen.....	26



General Information

Tips if Something Isn't Working.....	27
Glossary of TV Terms.....	28
Index	29
Factory Service Locations	30-31
Warranty.....	32

Here are a few of the special features built into this new Color Television:

SmartLock™ feature allows you to block the viewing of certain channel or external audio/video connections where you might not want your children viewing inappropriate material.

Infrared Remote Control works your TV set.

Standard broadcast (VHF/UHF) or Cable TV (CATV) channel capability.

Closed Captioning allows the viewer to read TV program dialogue or voice conversations as onscreen text.

Automatic Programming of Channels for quick and easy selection of favorite stations available in your area.

Onscreen Features (in either English, French, or Spanish) show helpful messages for setting of TV controls.

Sleep Timer automatically turns the TV OFF at pre-set times.

NOTE: This owner's manual is used with several different television models. Not all features (and drawings) discussed in this manual will necessarily match those found with your television system. This is normal and does not require you contacting your dealer or requesting service.

HOOKING UP YOUR TV (BASIC CABLE TV CONNECTIONS)



CABLE TV

Your Cable TV input into your home may be a single (75 ohm) cable, or a Converter Box installation. In either case the connection to the TV is very easy. Just put the threaded end of the cable signal to the TV's antenna plug and screw it down tight.

BEGIN

- 1 If your Cable TV signal is a single round cable (75 ohm) then you're ready to connect to the TV.

If you have a Cable Converter Box:

Connect the Cable TV signal to the Cable Signal IN(put) plug on the Converter..

- 2 Connect the Cable TV cable to the 75 Ω plug on the TV.

If you have a Cable Converter Box:
Connect the OUT(put) plug from the Converter to the 75 Ω plug on the TV.



SMART HELP



Remember:
Set the TV for the type signal you've just connected (see the "Tuner" section on page 11 of this manual.)

To select only the channel numbers on your Cable system see "Auto Program" (page 12). If you use a Cable Converter box, set the TV to the same channel as the converter's CH 3/4 switch (on the rear of the converter.)

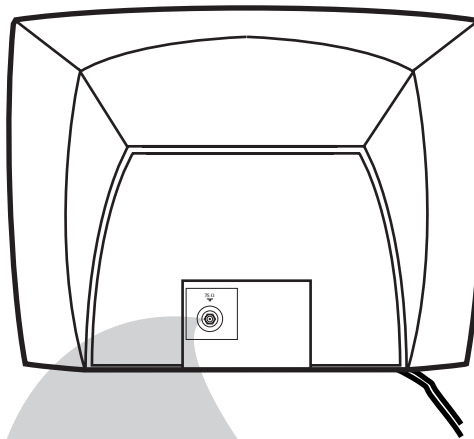

Cable TV Company



Cable TV Signal Input

OR

75 Ω
⌋⌋



Back of TV

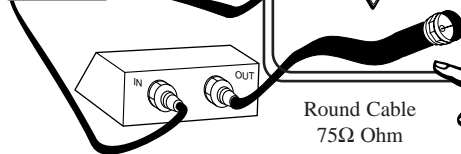

Round Cable
75Ω Ohm

Cable TV Converter
Box Connection

HOOKING UP YOUR TV (BASIC ANTENNA TV CONNECTIONS)

ANTENNA

A combination antenna receives normal broadcast channels (VHF 2-13 and UHF 14-69). Your connection is easy since there is only one 75Ω (ohm) antenna plug on the back of your TV - and that's where the antenna goes.

BEGIN

1 If your antenna has a round cable (75 ohm) on the end, then you're ready to connect it to the TV. If your antenna has flat twin-lead wire (300 ohm), you first need to attach the antenna wires to the screws on a 300 to 75 ohm adapter.

2 Push the round end of the adapter (or antenna) onto the 75 Ω plug on the rear of the TV. If the round end of the antenna wire is threaded, screw it down tight.

STOP

Note: For homes with separate UHF and VHF antennas you will need an optional combiner to connect to the TV.

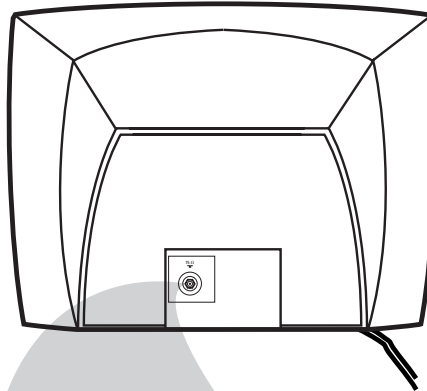
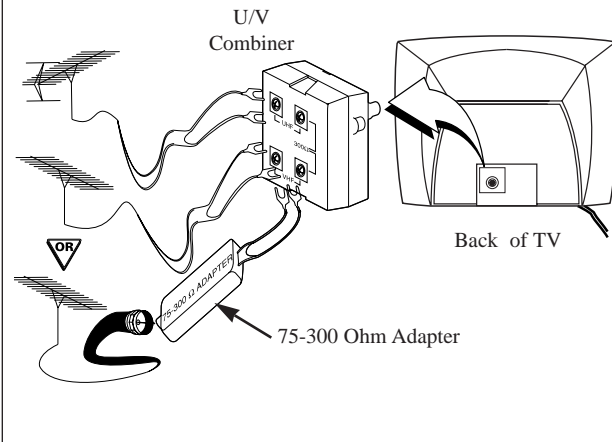

Combination VHF/UHF Antenna (Outdoor or Indoor)

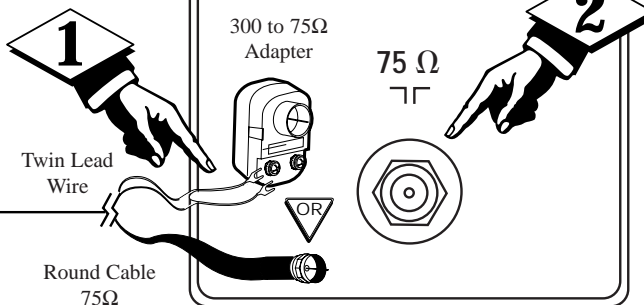
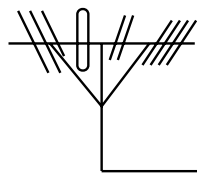

Back of TV

SMART HELP



Remember:

Be sure to set the TV for the type signal you've connected (see the "Tuner" section on page 11 of this manual.)

To set the TV to select only the channel numbers in your area see how to "Program" channels in the TV's memory on page 12 (Auto Program section).

To order any optional accessory contact your dealer or the Philips Parts Center at 1-800-851-8885.

HOOKING UP YOUR TV (BASIC TV TO VCR CONNECTIONS)



VCR TO TV

The basic Antenna, or Cable TV, to VCR to TV connection is shown to the right. For more information on other hookups (possible when Cable Converter/Descrambler boxes are included) refer to your accessory VCR and Cable Converter Owner's Manual for details.

BEGIN

- 1 Connect your Antenna or Cable TV signal to the IN FROM ANT(enna) plug on the VCR.
- 2 Connect the OUT TO TV plug on the VCR to the 75 Ω plug on the TV (connecting cable supplied with the VCR.)

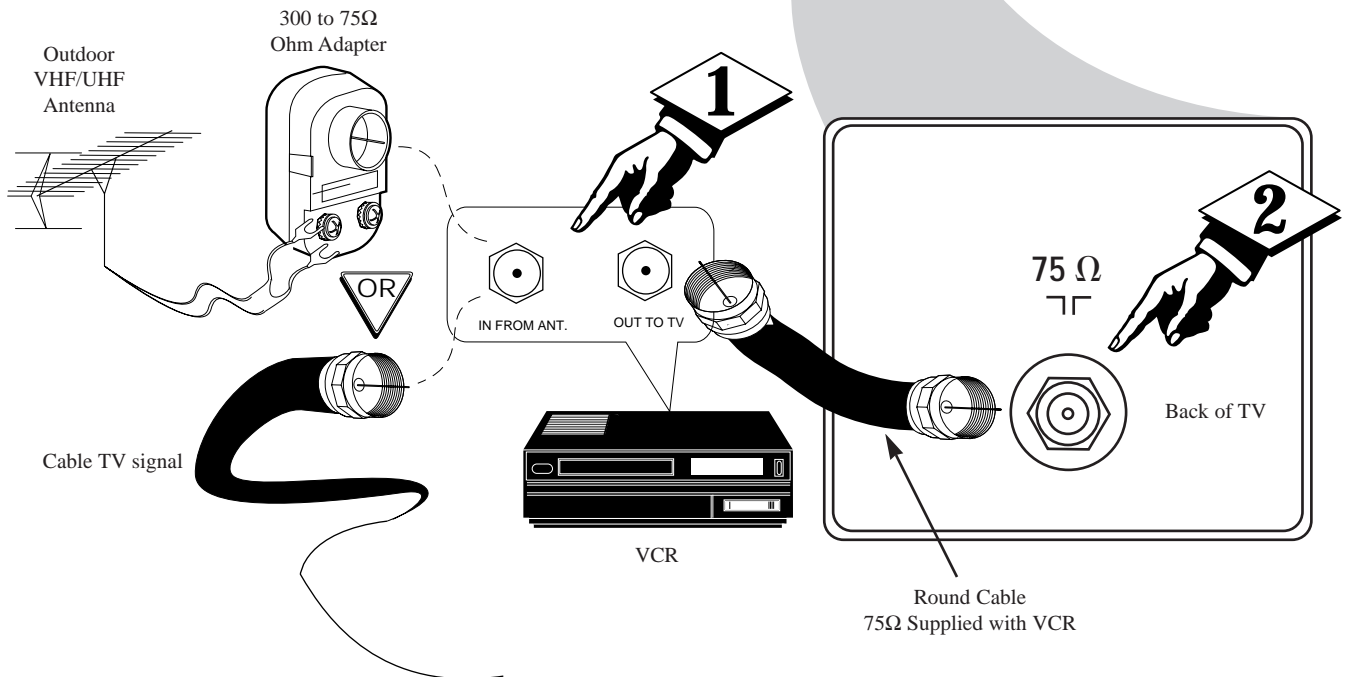
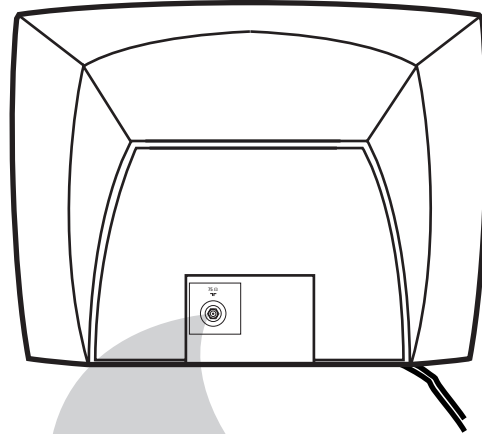

BASIC TV/REMOTE OPERATIONS

TELEVISION

BEGIN

- 1 Press the **POWER** button to turn the TV ON.
- 2 Press the **VOLUME +** button to increase the sound level or the **VOLUME -** button to lower the sound level.
Pressing both buttons at the same time will display the onscreen menu. Once in the menu, use these button to make adjustments or selections.
- 3 Press the **CHANNEL UP ▲** or **DOWN ▼** button to select TV channels.

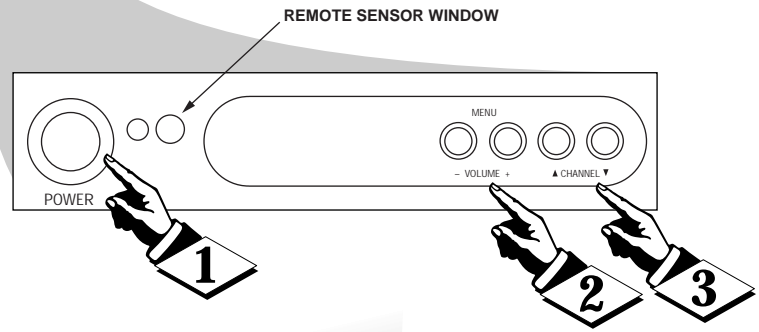
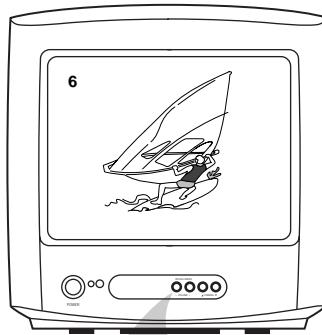

REMOTE

BATTERY INSTALLATION

To load the supplied batteries into the remote:

1. Remove the battery compartment lid on the back of the remote.
2. Place the batteries (2-AAA) in the remote. Be sure the (+) and (-) ends of the batteries line up correctly (inside of case is marked.)
3. Reattach the battery lid.

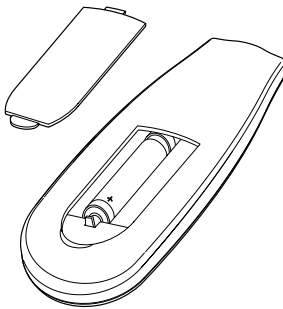

Point the remote control toward the remote sensor window on the TV when operating the TV with the remote.

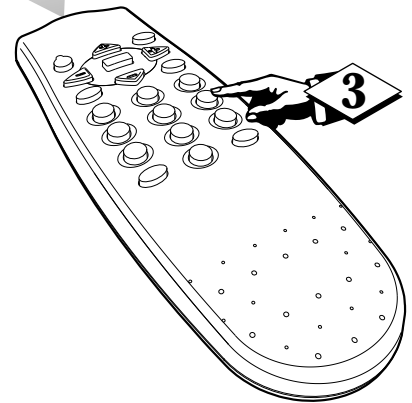

SMART HELP

 Remember, You can press any button on the front of the TV to turn the TV ON.

The tuned channel number will always appear briefly when the TV is first turned ON (and with channel changes.)

You can also press the STATUS/EXIT button (on the remote) to see what channel the TV is ON.

TV REMOTE BUTTONS



Power Button

Press to turn the TV ON and OFF.

Channel (+), (-) Buttons

Press to change the tuned channel.

Status/Exit Button

Press to see the current channel number on the TV screen. Also press to clear the TV screen after control adjustments.

Cursor Buttons

Use these buttons to select and adjust the TV's onscreen menu.

Volume (+), (-) Buttons

Press to adjust the TV sound level.

Mute Button

Press to turn the sound OFF on the TV. Press again to return the sound to its previous level.

Menu Button

Press for the onscreen menu to appear. Pressing the menu button after menu selections are made will return you to the previous menu screen or eliminate the menu from the display.

A/CH Button

Press to toggle between the currently viewed channel and the previously viewed channel.

Number Buttons

Press the number buttons to select TV channels. For single channel entries, press the numbered button of the channel you desire. The TV will pause for a few seconds before changing to the selected channel. For channels 100 and above, press "1" first, then the next two numbered buttons.

CC Button

Press to select Closed Caption options within the menu.

Sleep Button

Press to set the TV to automatically turn itself OFF.

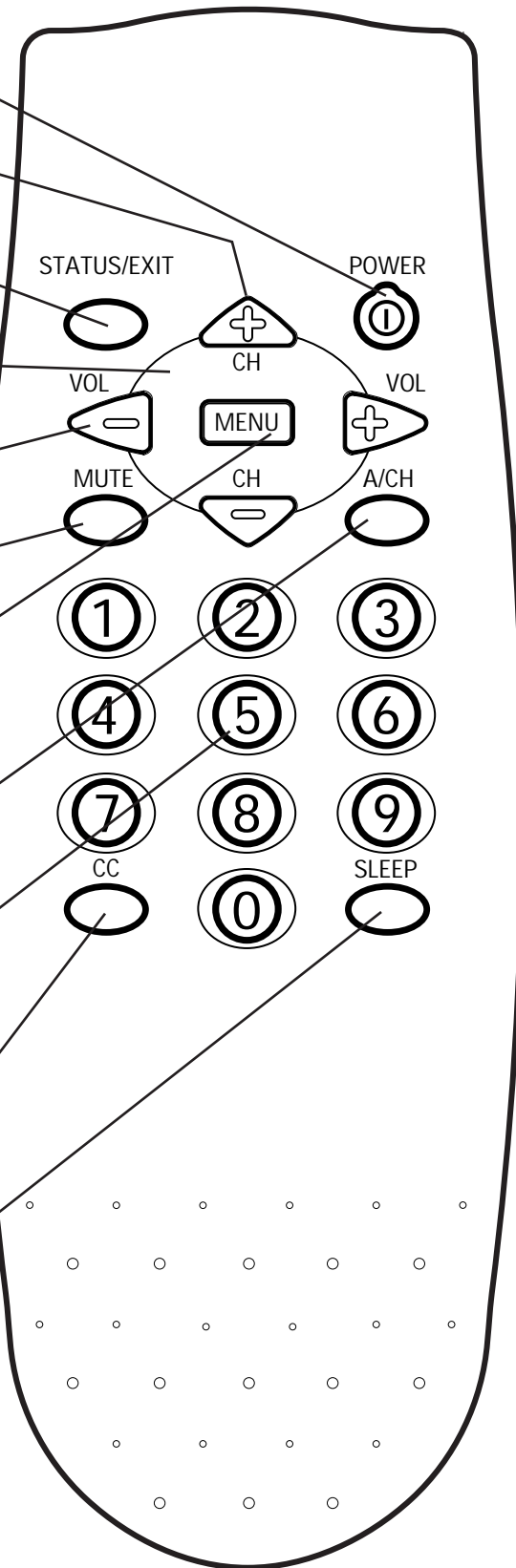

USING THE LANGUAGE CONTROL

For our Spanish and French speaking TV owners an onscreen LANGUAGE option is present. With the LANGUAGE control you can set the TV's onscreen menu to be shown in either English, Spanish, or French.

(BEGIN)

1 Press the **MENU** button on the remote to show the onscreen menu.

2 Press the **CURSOR UP ▲** or **DOWN ▼** buttons to scroll through the onscreen menu until the word **SETUP** is highlighted.

3 Press the **CURSOR RIGHT ►** button to display the **SETUP** menu features.

4 Press **CURSOR UP ▲** or **DOWN ▼** buttons to scroll the Setup features until the word **LANGUAGE** is highlighted.

5 Press the **CURSOR RIGHT ►** button repeatedly to select **ENGLISH**, **ESPANOL** (Spanish), or **FRANCAIS** (French).

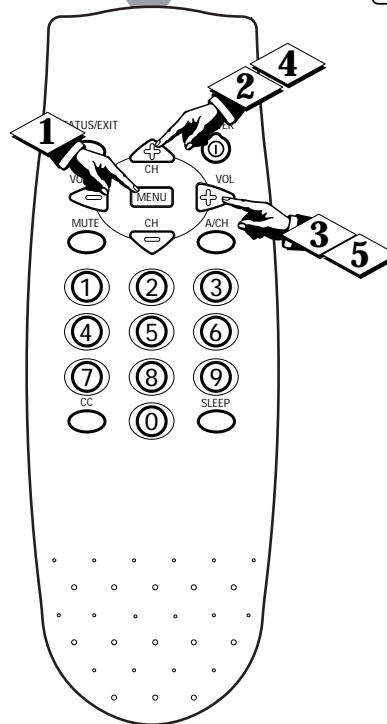
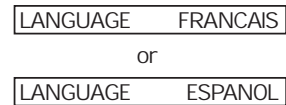
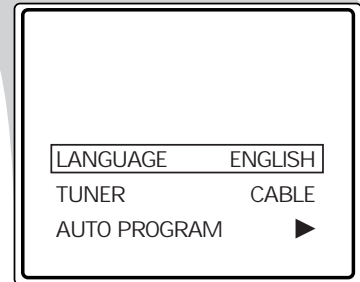
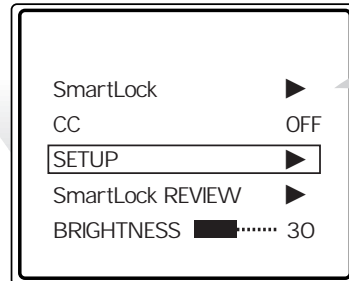

SMART HELP

Remember: The Language control only makes the TV's onscreen MENU items appear in English, Spanish, or French text.

It does not change the other onscreen text features such as Closed Caption (CC) TV shows.

The onscreen menu will time out and disappear from the screen when you finish, or you can press the STATUS/EXIT button to clear the menu from the screen.

USING THE TUNER CONTROL

The **TUNER** feature allows you to change the TV's signal input to either **CABLE**, **AUTO** or **ANTENNA** mode. It's important for the TV to know what type of signal to look for. (From a Cable TV signal or a normal Antenna signal.) In the **AUTO** mode, when the **AUTO PROGRAM** feature is activated, the TV will automatically choose the correct mode.

BEGIN

- 1 Press the **MENU** button on the remote to show the onscreen menu.
- 2 Press the **CURSOR UP ▲** or **DOWN ▼** buttons to scroll through the onscreen menu until the word **SETUP** is highlighted.
- 3 Press the **CURSOR RIGHT ►** button to display the **SETUP** menu features.
- 4 Press **CURSOR UP ▲** or **DOWN ▼** buttons to scroll the Setup features until the word **TUNER** is highlighted.
- 5 Press the **CURSOR RIGHT ►** button to select either **CABLE**, **AUTO** or **ANTENNA** mode.

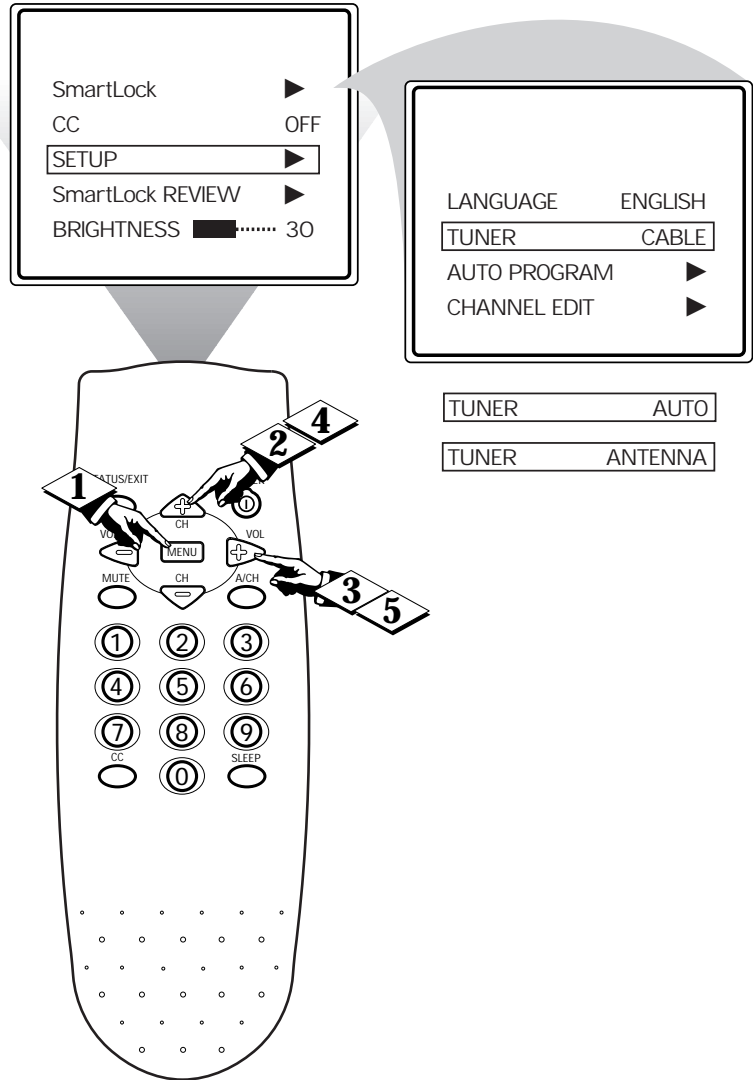

SMART HELP



When **CABLE** is selected, channels 1-125 are available.

When **ANTENNA** is selected, channels 2-69 are available.

When **AUTO** is selected, the TV will automatically set itself to the correct mode based on the type of signal it detects when the **AUTO PROGRAM** feature is activated.

The onscreen menu will time out and disappear from the screen when you finish, or you can press the **STATUS/EXIT** button to clear the menu from the screen.

USING THE AUTO PROGRAM CONTROL

Your TV can automatically set itself for local area (or Cable TV) channels. This makes it easy for you to select only the TV stations in your area when the CHANNEL (+), (-) buttons are pressed.

Note: Make sure the antenna or cable signal connection has been completed before AUTO PROGRAM control is used.

BEGIN

- 1 Press the **MENU** button on the remote to show the onscreen menu.
- 2 Press the **CURSOR UP ▲** or **DOWN ▼** buttons to scroll through the onscreen menu until the word **SETUP** is highlighted.
- 3 Press the **CURSOR RIGHT ►** button to display the **SETUP** menu features.
- 4 Press **CURSOR UP ▲** or **DOWN ▼** buttons to scroll the Setup features until the words **AUTO PROGRAM** are highlighted.
- 5 Press the **CURSOR RIGHT ►** button to start the Auto Program scanning of channels.

STOP

SMART HELP

Try it out. Press the CHANNEL (+), (-) buttons and see which channels have been added to the TV's memory.

If you want to delete any unwanted channels from the TV's memory, see the CHANNEL EDIT section on page 13.

The onscreen menu will time out and disappear from the screen when you finish, or you can press the STATUS/EXIT button to clear the menu from the screen.

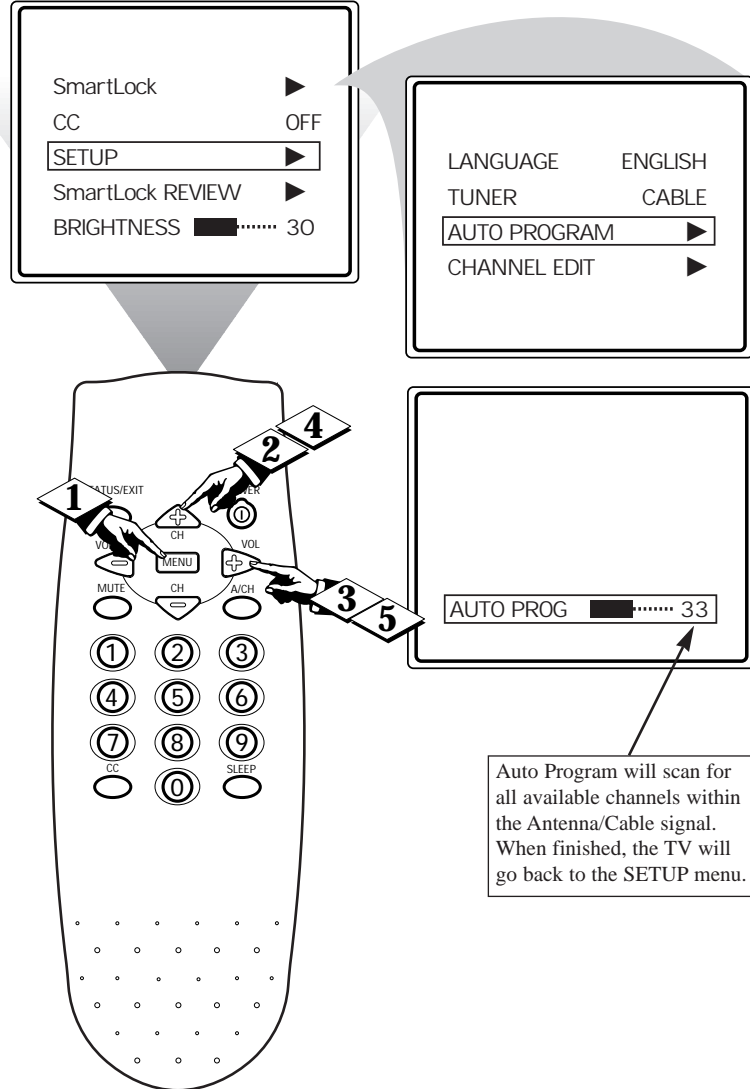

HOW TO ADD AND DELETE CHANNELS

Channel Edit makes it easy for you to **ADD** or **DELETE** channels from the list of channels stored in the TV's memory.

BEGIN

- 1** Press the **MENU** button on the remote to show the onscreen menu.
- 2** Press the **CURSOR UP ▲** or **DOWN ▼** buttons to scroll through the onscreen menu until the word **SETUP** is highlighted.
- 3** Press the **CURSOR RIGHT ►** button to display the **SETUP** menu features.
- 4** Press the **CURSOR UP ▲** or **DOWN ▼** buttons to scroll the Setup features until the words **CHANNEL EDIT** are highlighted.
- 5** Press the **CURSOR RIGHT ►** button to display the **CHANNEL EDIT** options.
- 6** With the **CHANNEL EDIT** options displayed and the word **CHANNEL** highlighted; enter the channel number (with the **NUMBERED** or the **CURSOR ►** or **◀** buttons) you wish to **ADD** to, or **DELETE** from the TV's memory.
- 7** Scroll down (using the **CURSOR UP ▲** or **DOWN ▼** buttons) to highlight the word **SAVED**. Now use the **CURSOR RIGHT ►** button to toggle between **YES** or **NO**.
If **YES** is selected the menu reads "**CHANNEL ADDED**" and the channel is added to the TV's memory. If **NO** is selected the menu reads "**CHANNEL DELETED**" and the channel is deleted from the TV's memory.

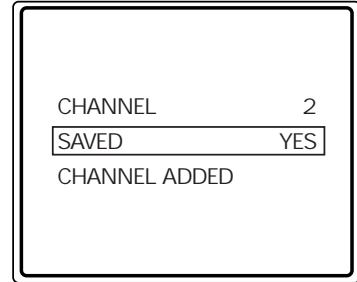
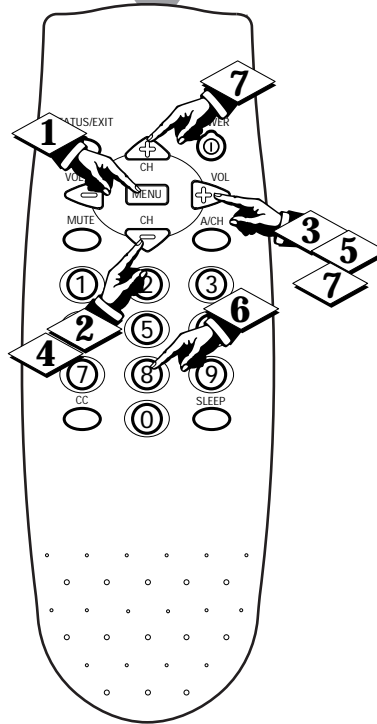
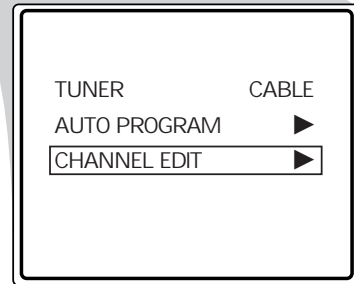
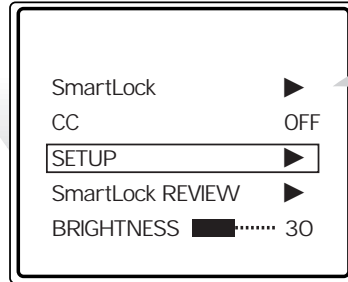

OR

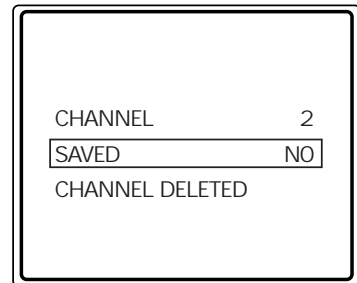

HOW TO ADJUST THE TV PICTURE

To adjust your TV picture controls, select a channel and follow the steps shown below:

BEGIN

- 1 Press the **MENU** button on the remote to display the onscreen menu.
- 2 Press the **CURSOR UP ▲** or **DOWN ▼** buttons until the word **BRIGHTNESS** is highlighted. (Or, COLOR, PICTURE, SHARPNESS, TINT, COL. TEMP depending on the adjustment you want to make.)
- 3 Press the **CURSOR RIGHT ▶** or the **CURSOR LEFT ◀** buttons to increase or decrease the brightness of the picture.

STOP



SMART HELP

BRIGHTNESS Press the **▶** or **◀** buttons until darkest parts of the picture are as bright as you prefer.

COLOR Press the **▶** or **◀** buttons to add or eliminate color.

PICTURE Press the **▶** or **◀** buttons until lightest parts of the picture show good detail.

SHARPNESS Press the **▶** or **◀** buttons to improve detail in the picture.

TINT Press the **▶** or **◀** buttons to obtain natural skin tones.

The onscreen menu will time out and disappear from the screen when you finish, or you can press the **STATUS/EXIT** button to clear the menu from the screen.

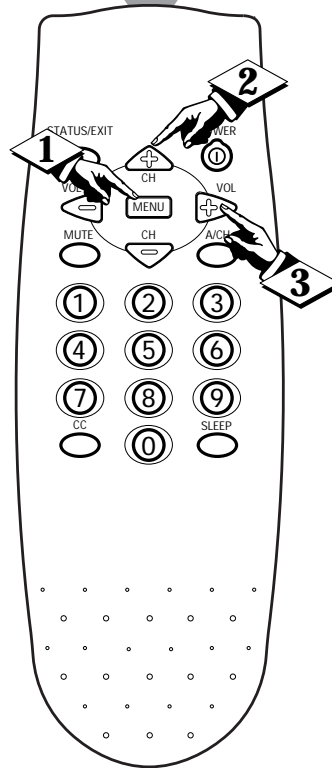
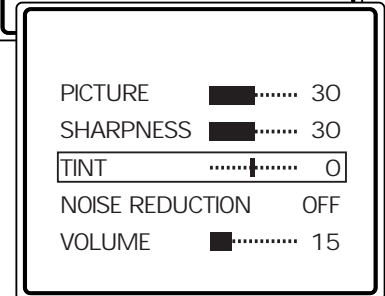
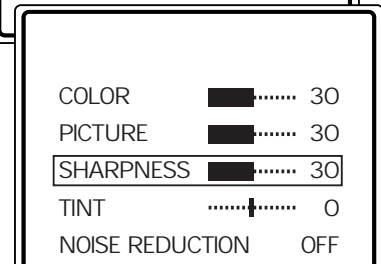
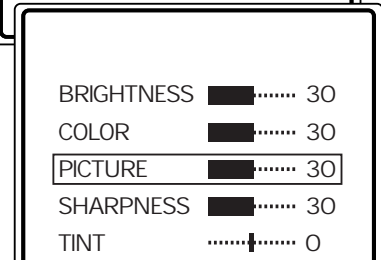
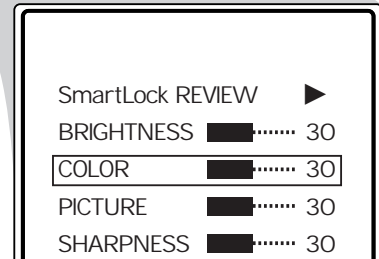
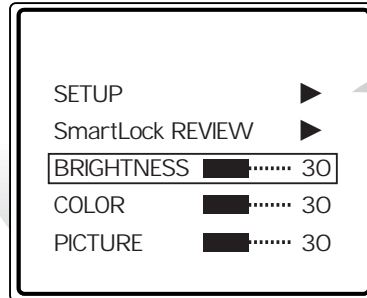

ACTIVATING THE NOISE REDUCTION (PICTURE) CONTROL



For reasons, such as poor cable reception, the picture can sometimes appear slightly “speckled” (or signal noise shown in the picture). The **NOISE REDUCTION** control can help eliminate this type of interference and improve the quality of the picture.

BEGIN

- 1 Press the **MENU** button on the remote to display the onscreen menu.
- 2 Press the **CURSOR UP ▲** or **CURSOR DOWN ▼** button until the words **NOISE REDUCTION** are highlighted.
- 3 Press the **CURSOR RIGHT ►** or **CURSOR LEFT ◀** buttons to activate or deactivate the Noise Reduction Feature.



SMART HELP



Remember: The onscreen menu will disappear in a few seconds after you have finished your adjustment.

“Noise” Reduction is a video adjustment feature that affects the picture quality of the TV not the sound.

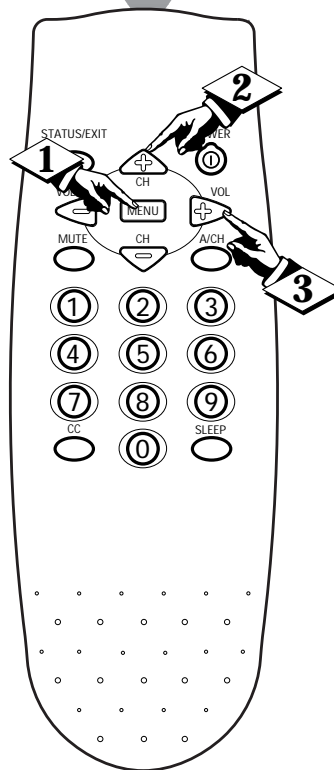
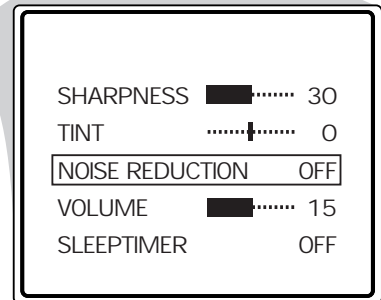
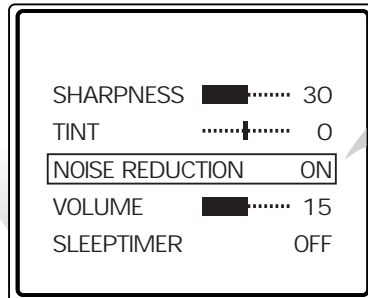

USING THE CLOSED CAPTION CONTROL

Closed Captioning (CC) allows you to read the voice content of television programs on the TV screen. Designed to help the hearing impaired, this feature uses onscreen "text boxes" to show dialogue and conversations while the TV program is in progress.

BEGIN

- 1 Press the **MENU** button on the remote to display the onscreen menu.
- 2 Press the **CURSOR UP ▲** or **CURSOR DOWN ▼** button until the word **CC** (Closed Caption) is highlighted.
- 3 Press the **CURSOR RIGHT ►** button to select the **CLOSED CAPTION** option you want (**OFF**, **1**, **2**, or **MUTE**). Dialogue (and descriptions) for the action on the captioned TV program will appear onscreen.
- 4 **NOTE:** You can also set the Closed Caption by **pressing the CC button** on the remote. When pressed repeatedly the screen will display the options: **CC-OFF**, **CC-1**, **CC-2**, or **CC-MUTE**.



SMART HELP

Remember: The onscreen menu will time out and disappear from the screen when you finish, or you can press the **STATUS/EXIT** button to clear the menu from the screen.

NOTE: Not all TV programs and product commercials are made for broadcast with Closed Caption (CC) information included. Neither are all Closed Caption modes (CC-1, or CC-2) necessarily being used by a broadcast station during the transmission of a closed caption program. Refer to your area's TV program listings for the stations and times of Closed Caption shows.

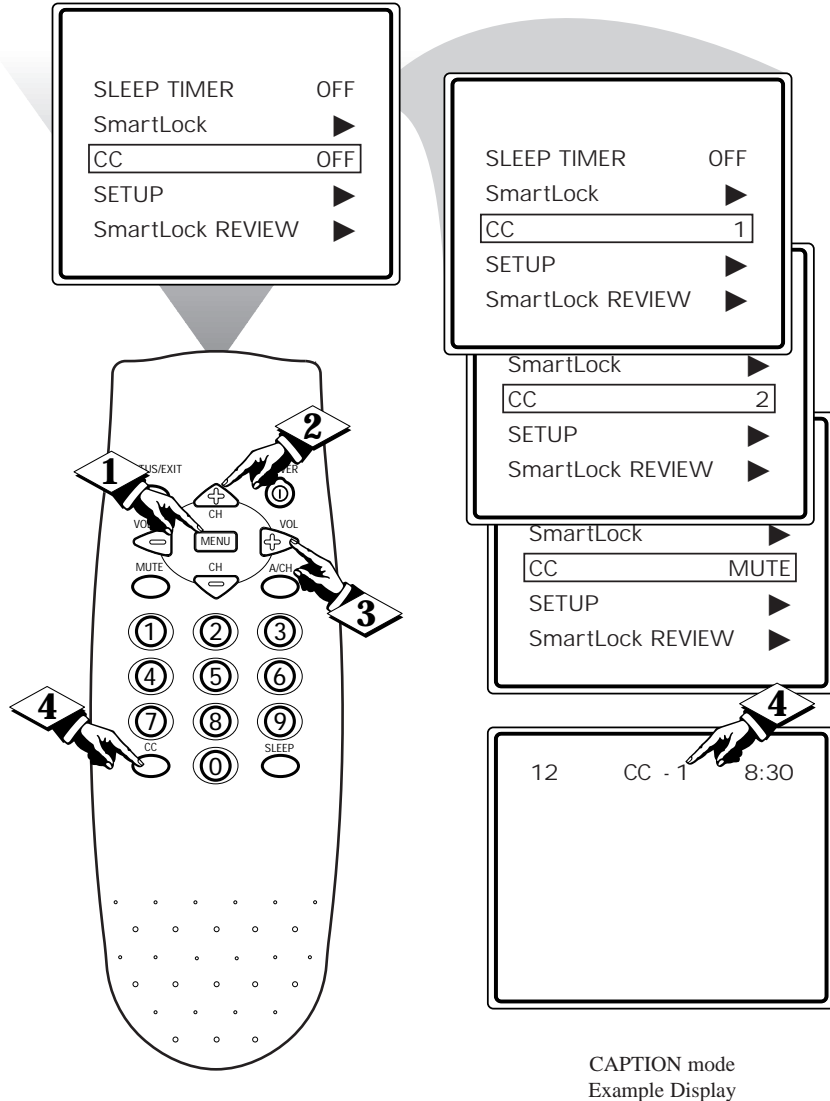

CAPTION mode
Example Display

NOTE: The **CC-MUTE** option can be used to set the TV to turn the Closed Caption **CC-1** mode "ON" whenever the **MUTE** button on the remote is pressed. "MUTE" will be displayed smaller in the upper center of the screen.



USING THE SLEEP TIMER CONTROL

Have you ever fallen asleep in front of the TV only to have it wake you up at two in the morning with a test pattern screeching in your ears? Well, your TV can save you all that trouble by automatically turning itself off.

BEGIN

1 Press the **SLEEP** button on the remote control and the SLEEP timer display will appear on the screen.

2 Press the **SLEEP** button repeatedly to pick the amount of time (in 15 minute increments up to 60 minutes; then 30 minute increments up to 120 minutes; then 60 minute increments up to 240 minutes) before the TV will turn itself off.

An onscreen count down will appear during the last minute before the TV shuts itself off.



SMART HELP

Remember: The SLEEP-TIMER control can also be set within the TV's main menu.

The onscreen menu will time out and disappear from the screen when you finish, or you can press the STATUS/EXIT button to clear the menu from the screen.

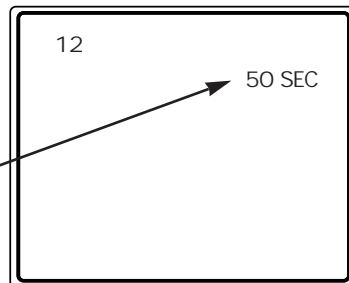
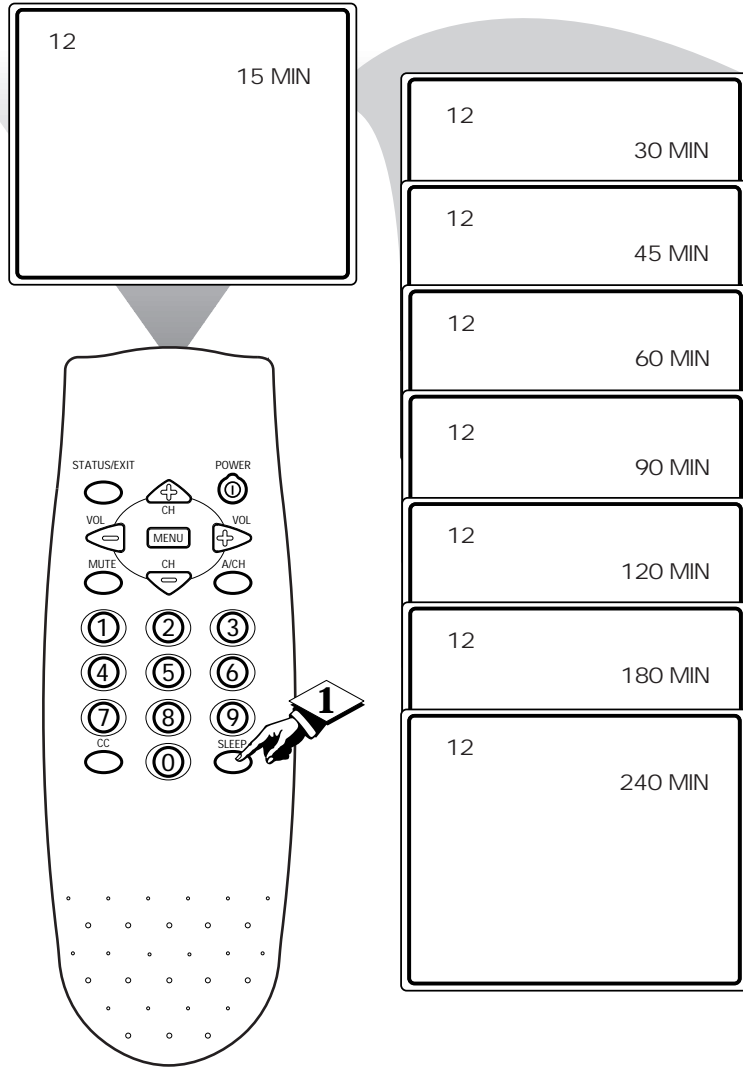

During the last minute of a SLEEP timer setting, an onscreen count down will be displayed. Pressing any button during the last minute will cancel the SLEEP timer.

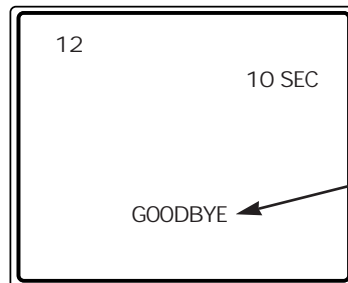

During the last 10 seconds of a SLEEP timer setting, an onscreen display will read GOOD BYE.



USING THE TV VOLUME BAR CONTROL

Use the Volume Bar control to see the TV's volume level settings on the TV screen. The Volume Bar will be seen each time the VOLUME buttons (on the TV or remote) are pressed.

BEGIN

- 1 Press the MENU button to display the onscreen menu.
- 2 Press the CURSOR UP ▲ or CURSOR DOWN ▼ buttons until the word VOLUME is highlighted.
- 3 Press the CURSOR RIGHT ► button to increase the TV's volume or the CURSOR LEFT ◀ button to decrease the sound.

STOP

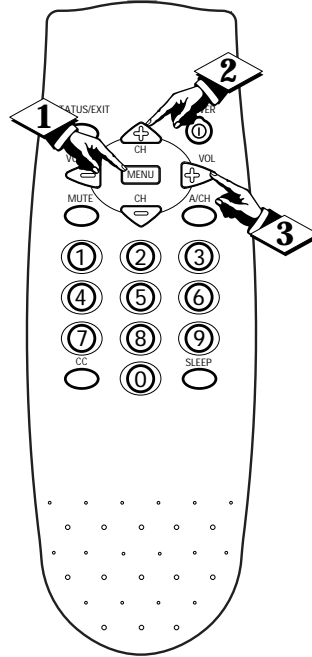
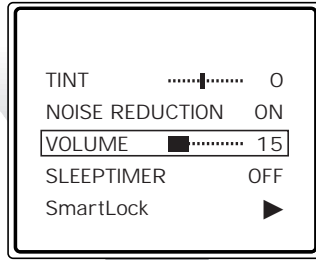

OR

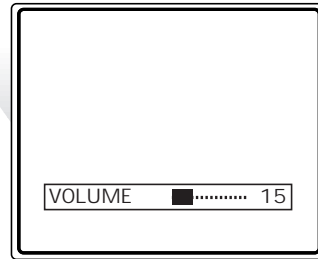

Note: Pressing the VOL (+) or (-) buttons will also allow you to adjust the sound level of the TV. A Volume Bar adjustment will appear onscreen. Press the (+) to increase the volume and the (-) button to decrease the volume.

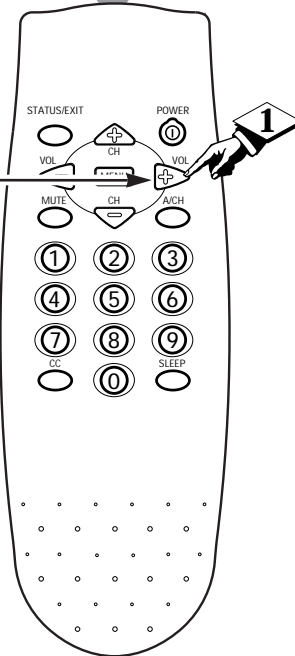

USING THE TV'S ALTERNATE CHANNEL BUTTON



The Alternate Channel option allows you to move between two channels with the simple touch of one button.

BEGIN

- 1 Press the **CHANNEL (+) or (-) buttons** (or the **NUMBER buttons**) to select a channel.
- 2 Press the **CHANNEL (+) or (-) buttons** (or the **NUMBER buttons**) to select a second channel.
- 3 Now, by **pressing the A/CH (Alternate Channel) button** on the remote, you can toggle between the two selected channels.

Alternate Channel simply allows you to toggle between the presently viewed channel and the most recently viewed channel.

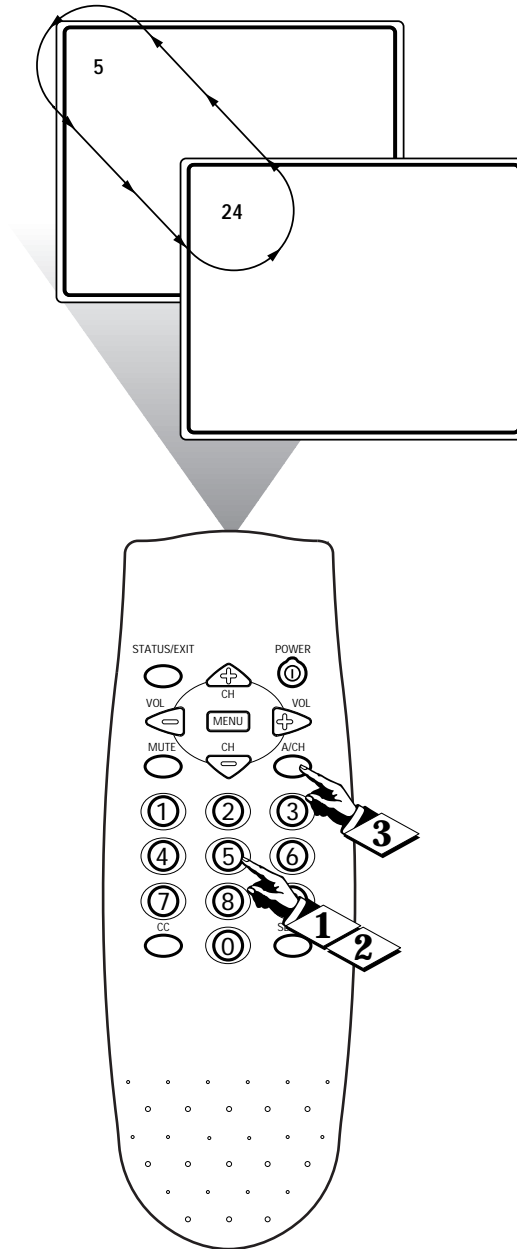



UNDERSTANDING THE SMARTLOCK™ CONTROL

The SmartLock feature is an integrated circuit that receives and processes data sent by broadcasters, or other program providers, that contain program content advisories. When programmed by the viewer, a TV with SmartLock can respond to the content advisories and block program content that may be found objectionable (such as offensive language, violence, sexual situations, etc.). This is a great feature to censor the type of viewing children may watch.

Over the next few pages you'll learn how to block channels and certain rated programming. Below is a brief explanation of some terms and ratings you will find in the SmartLock feature.

SmartLock offers various **BLOCKING OPTION** controls from which to choose:

MASTER DISABLE: This is what might be called the "master switch" for SmartLock. When in the ON position, ALL blocking/censoring is turned off (or disabled). When in the OFF position, ALL blocking based on specifically blocked settings will take place.

BLOCK UNRATED: ALL unrated programs based on the Movie Ratings or Parental (TV) Guidelines can be blocked if this feature is set to ON and the MASTER DISABLE feature is set to OFF.

BLOCK NO RATINGS: ALL programming with NO content advisory data can be blocked if this feature is set to ON and the MASTER DISABLE feature is set to OFF.

After an access code has been programmed, you can block up to 5 individual channels. But more than just blocking channels, certain blocking options exist which will block programming based on ratings patterned by the Motion Pictures Association of America and TV broadcasters. (See description of ratings on this page.)

G	OFF
PG	OFF
PG-13	OFF
R	ON
NC-17	ON
X	ON

TV-Y	OFF
TV-Y7	▶
TV-G	OFF
TV-PG	▶
TV-14	▶
TV-MA	▶

MOVIE RATINGS

(MOTION PICTURE ASSOCIATION OF AMERICA)

G: General Audience - All ages admitted. Most parents would find this program suitable for all ages. This type of programming contains little or no violence, no strong language, and little or no sexual dialogue or situations.

PG: Parental Guidance Suggested - This programming contains material that parents may find unsuitable for younger children.) It may contain one or more of the following: Moderate violence, some sexual situations, infrequent coarse language, or some suggestive dialogue.

PG-13: Parents Strongly Cautioned - This programming contains material that parents may find unsuitable for children under the age of 13. It contains one or more of the following: violence, sexual situations, coarse language, or suggestive dialogue.

R: Restricted - This is programming is specifically designed for adults. Anyone under the age of 17 should only view this programming with an accompanying parent or adult guardian. It contains one or more of the following: intense violence, intense sexual situations, strong coarse language, or intensely suggestive dialogue.

NC-17: No one under the age of 17 will be admitted. - This type of programming should be viewed by adults only. It contains graphic violence, explicit sex, or crude indecent language.

X: Adults Only - This type of programming contains one or more of the following: very graphic violence, very graphic and explicit or indecent sexual acts, very coarse and intensely suggestive language.

TV PARENTAL GUIDELINES (TV BROADCASTERS)

TV-Y **TV-Y** - (All children -- This program is designed to be appropriate for all children.) Designed for a very young audience, including children ages 2-6. This type of programming is not expected to frighten younger children.

TV-Y7 **TV-Y7** - (Directed to Older Children -- This program is designed for children age 7 and above.) It may be more appropriate for children who have acquired the development skills needed to distinguish between make-believe and reality. This programming may include mild fantasy and comic violence (FV).

TV-G **TV-G** - (General Audience -- Most parents would find this program suitable for all ages.) This type of programming contains little or no violence, no strong language, and little or no sexual dialogue or situations.

TV-PG **TV-PG** - (Parental Guidance Suggested -- This program contains material that parents may find unsuitable for younger children.) This type of programming contains one or more of the following: Moderate violence (V), some sexual situations (S), infrequent coarse language (L), or some suggestive dialogue (D).

TV-14 **TV-14** - (Parents Strongly Cautioned -- This program contains some material that many parents would find unsuitable for children under 14 years of age.) This type of programming contains one or more of the following: intense violence (V), intense sexual situations (S), strong coarse language (L), or intensely suggestive dialogue (D).

TV-MA **TV-MA** - (Mature Audience Only -- This program is specifically designed to be viewed by adults and therefore may be unsuitable for children under 17.) This type of programming contains one or more of the following: graphic violence (V), explicit sexual situations (S), or crude indecent language (L).



The SmartLock feature is an integrated circuit that receives and processes data sent by broadcasters, or other program providers, that contain program content advisories. When programmed by the viewer, a TV with SmartLock can respond to the content advisories and block program content that may be found objectionable (such as offensive language, violence, sexual situations, etc.). This is a great feature to censor the type of viewing children may watch.

Over the next few pages you'll learn how to block channels and get a better understanding of the rating terms for certain programming. First, let's start by learning how to set a personal access code:

(BEGIN)

- 1 Press the **MENU** button on the remote to display the onscreen menu.
- 2 Press the **CURSOR UP ▲** or **CURSOR DOWN ▼** buttons until the words **SmartLock** are highlighted.
- 3 Press the **CURSOR RIGHT ►** button to display the SmartLock Access Code screen.
- 4 Using the **NUMBERED** buttons, enter **0, 7, 1, 1**. "XXXX" appears on the Access Code screen as you press the numbered buttons. "INCORRECT CODE" will appear on the screen, and you will need to enter **0, 7, 1, 1** again.
- 5 Press the **CURSOR DOWN ▼** button until the words **CHANGE CODE** are highlighted.
- 6 Press the **CURSOR RIGHT ►** button to change your personal Access Code.
- 7 "Next enter a "new" 4 digit code using the **NUMBERED** buttons. The screen will then ask you to confirm the code you just entered. **Enter your new code again.** "XXXX" will appear when you enter your new code.
- 8 Press the **STATUS/EXIT** button to save the new code in the TV's memory.

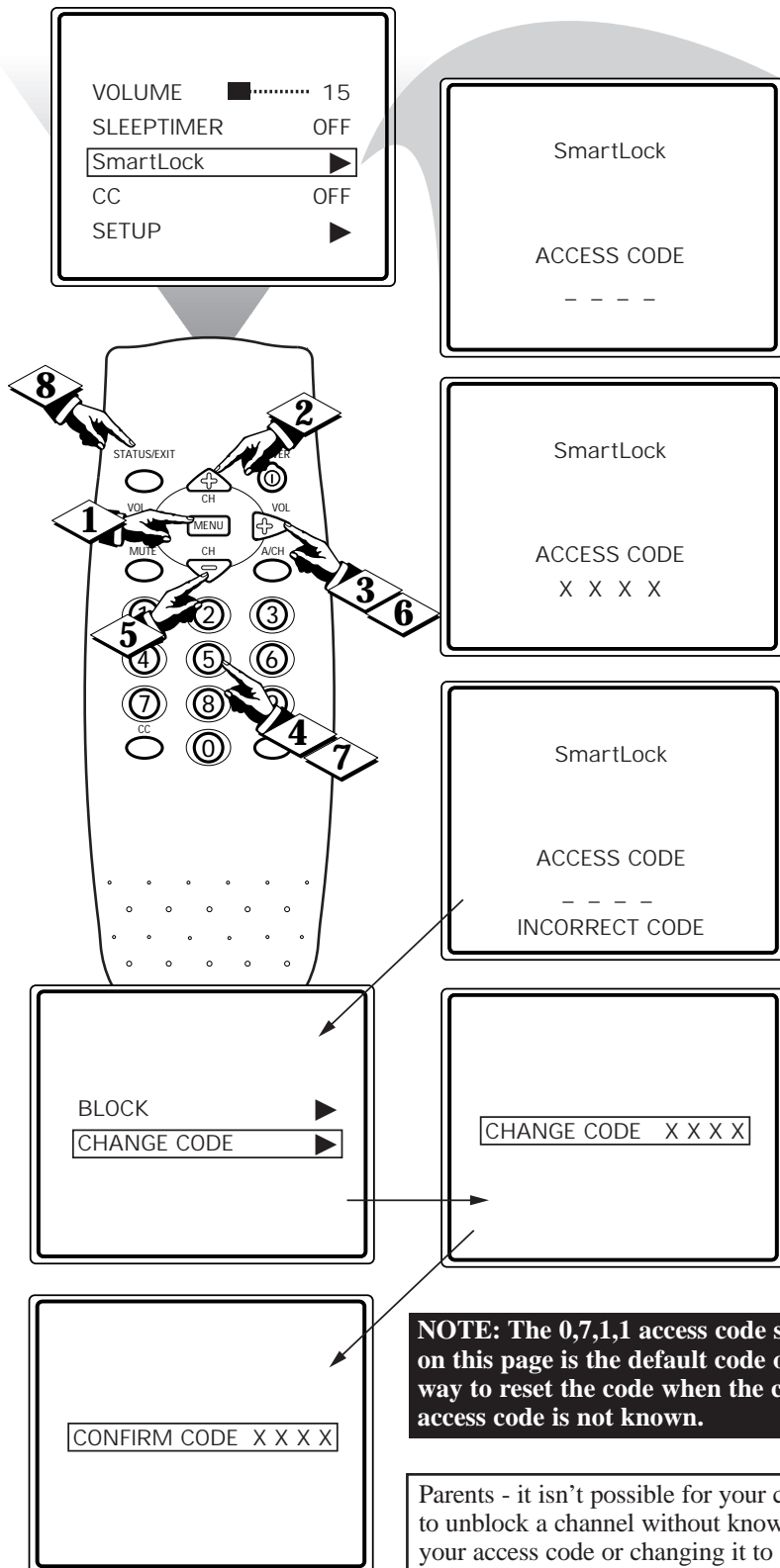

NOTE: The 0,7,1,1 access code shown on this page is the default code or a way to reset the code when the current access code is not known.

Parents - it isn't possible for your child to unblock a channel without knowing your access code or changing it to a new one. If your code changes, and you didn't change it, then you know it's been altered by someone else and blocked channels have been viewed.



UNDERSTANDING THE SMARTLOCK™ CONTROL (BLOCK CHANNEL)

After your personal access code has been set (see previous page), you are now ready to select the channels you want to block out or censor.

(BEGIN)

- 1 Press the **MENU** button on the remote to show the onscreen menu.
- 2 Press the **CURSOR UP ▲** or **CURSOR DOWN ▼** button until the words **SmartLock** are highlighted.
- 3 Press the **CURSOR RIGHT ►** button to display the SmartLock Access screen.
- 4 Enter the correct access code number. "XXXX" shows on the Access Code display as you press the **NUMBERED** buttons.
- 5 Press the **CURSOR UP ▲** or **CURSOR DOWN ▼** buttons until the word **BLOCK** is highlighted. Press the **CURSOR RIGHT ►** button then highlight **CHANNELS BLOCKED**.
- 6 Press the **CURSOR RIGHT ►** button. Three options will be displayed; **CHANNEL**, **LOCK** or **CLEAR ALL**.
- 7 With **CHANNEL** highlighted, use the **NUMBERED** buttons to enter the channel number you wish to block.
- 8 Use the **CURSOR DOWN ▼** button to highlight the word **LOCK**, then press the **CURSOR RIGHT ►** button to select **YES** (block) or **NO** (do not block). The channel chosen is now blocked from viewing.

Repeat steps 7 and 8 for any other channels you wish to block from viewing.

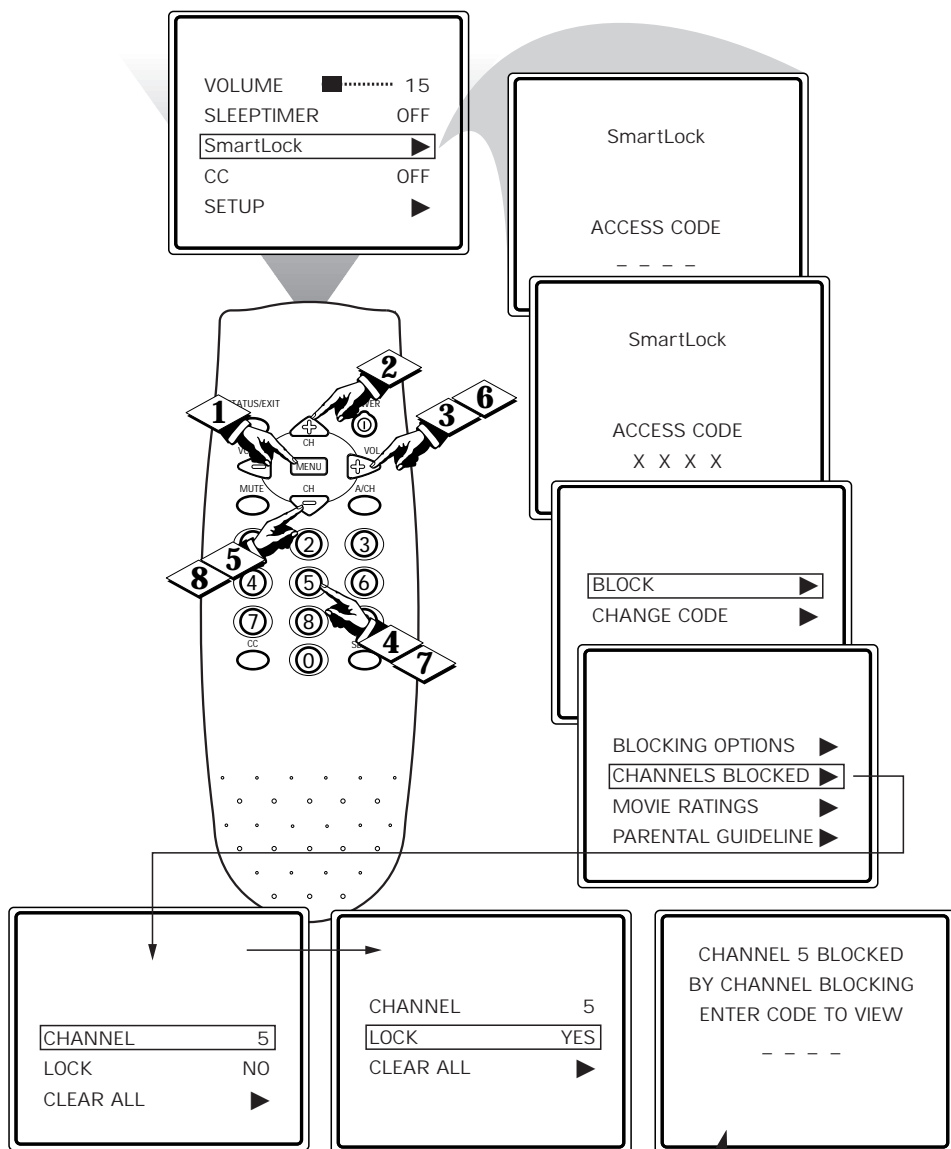

When a blocked channel is viewed, this is what the screen will display. To view the blocked channel, simply enter the current access code. Note: Once the access code is entered ALL blocked channels will be viewable until the TV is powered off. Once the set is turned off and then back on the previously blocked channels will again be blocked.

To clear blocked channels follow the steps below:

Press the **CURSOR DOWN ▼** button until the words **CLEAR ALL** are highlighted, then press the **CURSOR RIGHT ►** button.

The screen will read "ALL UNBLOCKED" for a moment. At this point ALL the previously blocked channels will be unblocked.

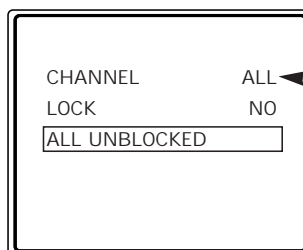
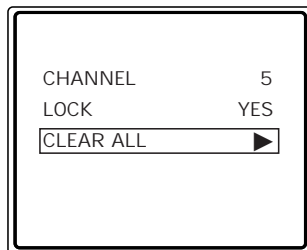

Note: When the **CLEAR ALL** option is selected, the **CHANNEL** option will display **ALL**. If at this point if you change the **LOCK** option to **YES**, ALL channels will be blocked from viewing.

UNDERSTANDING THE SMARTLOCK™ CONTROL (BLOCKING OPTIONS)



SmartLock offers the viewer other blocking features as well. With these Blocking Option features, the censoring can be turned ON or OFF.

BEGIN

- 1 Press the **MENU** button on the remote to display the onscreen menu.
- 2 Press the **CURSOR UP ▲** or **CURSOR DOWN ▼** buttons until the words **SmartLock** are highlighted.
- 3 Press the **CURSOR RIGHT ►** button to display the SmartLock Access Code screen.
- 4 Using the **NUMBERED** buttons on the remote, enter your personal Access Code.
- 5 With the word **BLOCK** highlighted, Press the **CURSOR RIGHT ►** button.
- 6 Scroll the menu using the **CURSOR UP ▲** or **CURSOR DOWN ▼** buttons until the words **BLOCKING OPTIONS** are highlighted.
- 7 Press the **CURSOR RIGHT ►** button to display the **Blocking Options (MASTER DISABLE, BLOCK UNRATED, or BLOCK NO RATING)**. When highlighted, each feature can be turned **ON** or **OFF** using the **CURSOR RIGHT ►** or **CURSOR LEFT ◀** buttons on the remote.

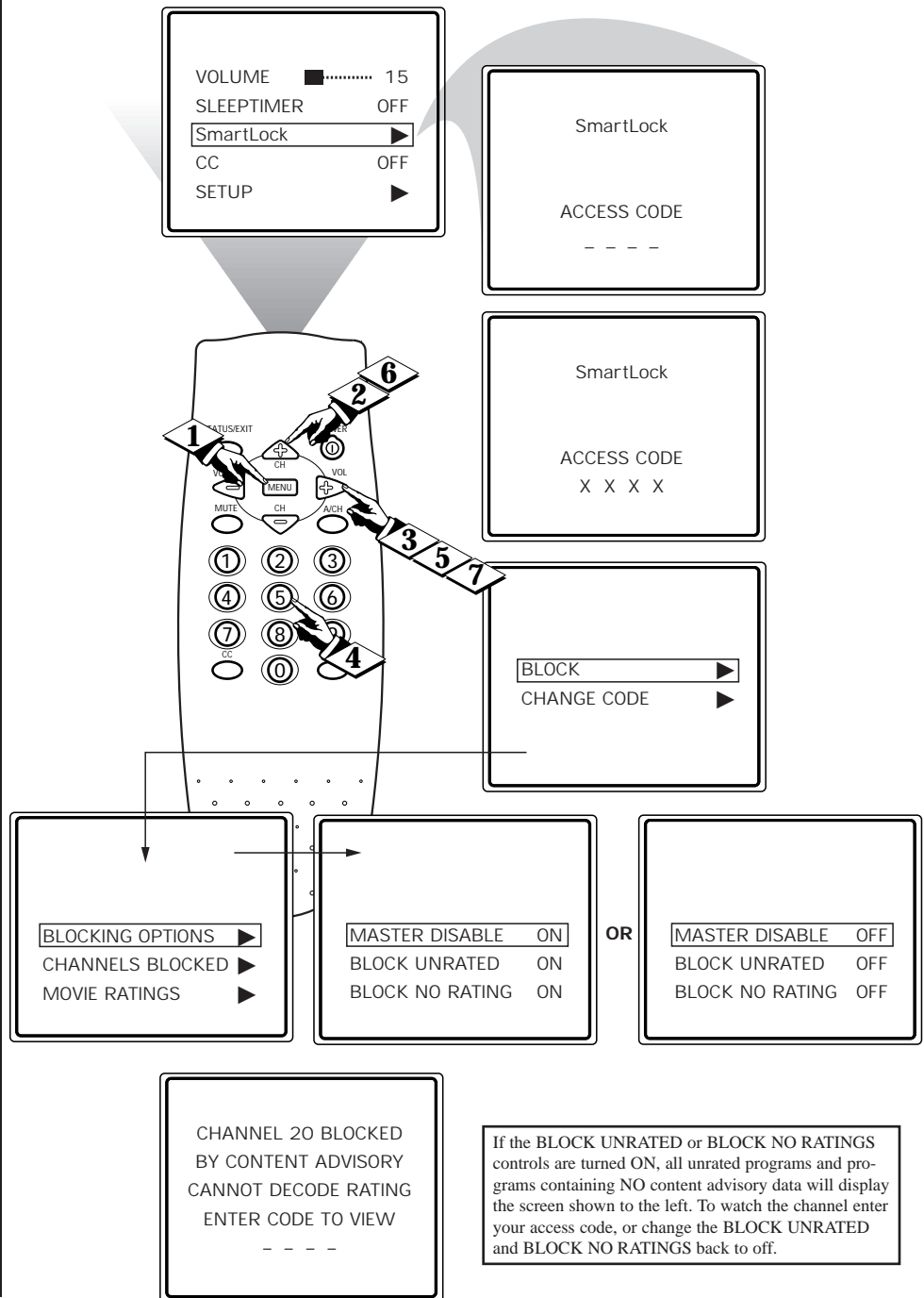

BLOCKING OPTIONS:

MASTER DISABLE: This is what might be called the “master switch” for SmartLock. When in the ON position, ALL blocking/censoring is turned off (or disabled). When in the OFF position, ALL blocking based on specifically blocked settings will take place.

BLOCK UNRATED: ALL unrated programs based on the Movie Ratings or Parental (TV) Guidelines can be blocked if this feature is set to ON and the MASTER DISABLE feature is set to OFF.

BLOCK NO RATINGS: ALL programming with NO content advisory data can be blocked if this feature is set to ON and the MASTER DISABLE feature is set to OFF.

If the BLOCK UNRATED or BLOCK NO RATINGS controls are turned ON, all unrated programs and programs containing NO content advisory data will display the screen shown to the left. To watch the channel enter your access code, or change the BLOCK UNRATED and BLOCK NO RATINGS back to off.

UNDERSTANDING THE SMARTLOCK™ CONTROL (MOVIE RATINGS)

SMART HELP



Remember:
Selecting to block any rating will cause all the higher ratings to also be blocked automatically.

There are two types of program ratings within the SmartLock feature. One is based on the Movie Industry ratings while the other is based on the TV Industry ratings. Both can be used to block or censor programming that has been rated in either manner.

Let's first look at the Movie Rating options of SmartLock:

BEGIN

- 1 Press the **MENU** button on the remote to display the onscreen menu.
- 2 Press the **CURSOR UP ▲** or **CURSOR DOWN ▼** buttons until the words **SmartLock** are highlighted.
- 3 Press the **CURSOR RIGHT ►** button to display the SmartLock Access Code screen.
- 4 Using the **NUMBERED** buttons on the remote, enter your Personal Access Code.
- 5 With the word **BLOCK** highlighted, Press the **CURSOR RIGHT ►** button.
- 6 Scroll the menu using the **CURSOR UP ▲** or **CURSOR DOWN ▼** buttons until the words **MOVIE RATINGS** are highlighted.
- 7 Press the **CURSOR RIGHT ►** button to display the **MOVIE RATINGS (G, PG, PG-13, R, NC17, or X)**.

When highlighted, all these options can be turned **ON** (which will allow blocking) or **OFF** (which will allow viewing).

Use the **CURSOR RIGHT ►** or **CURSOR LEFT ◀** buttons on the remote to turn the rating option **ON** or **OFF**.

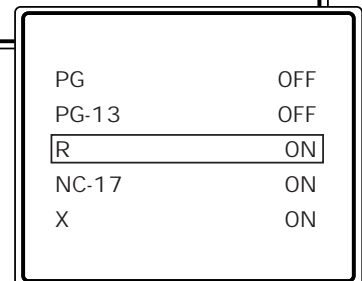
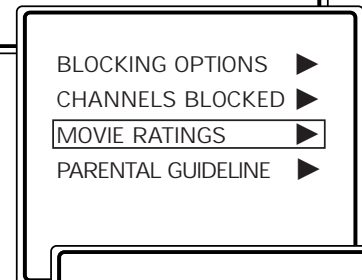
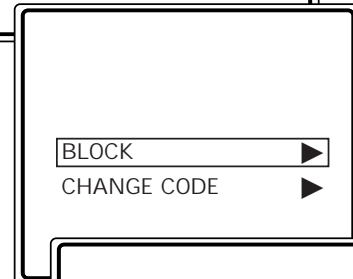
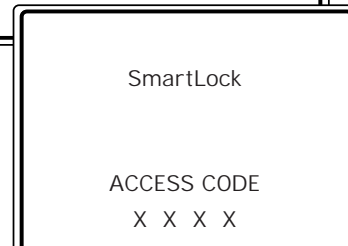
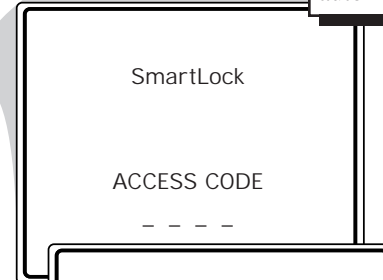
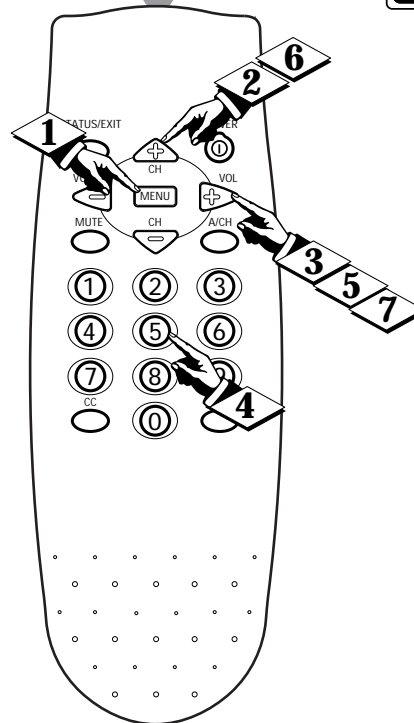
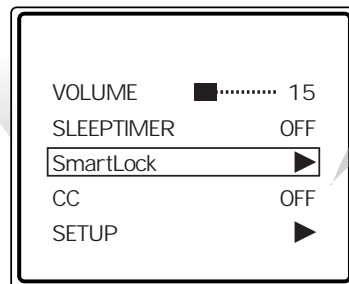

NOTE: When a rating is turned ON, all higher ratings will automatically be turned ON. To turn them OFF, you will have to set each rating individually. (i.e., R blocked manually, NC-17 and X will be blocked automatically.)

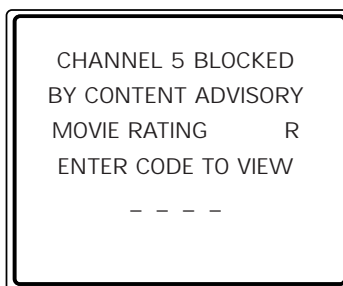

Screen will display a message when programming is blocked by the Movie Rating feature. To unblock, turn the Movie Rating OFF, or enter your personal access code. Entering the code will unblock ALL blocked Movie Ratings until the TV is turn off. Then the blocked ratings will be reset to ON.

UNDERSTANDING THE SMARTLOCK™ CONTROL (PARENTAL GUIDELINE)



This portion of the SmartLock features cover program ratings based on the TV Industry rating system. This is known as Parental Guideline within SmartLock.

After selecting the SmartLock feature and entering your personal access code, the BLOCK/CHANGE CODE screen appears;

BEGIN

- 1 With the word **BLOCK** highlighted, Press the **CURSOR RIGHT** button.
- 2 Scroll the menu using the **CURSOR UP** or **CURSOR DOWN** buttons until the words **PARENTAL GUIDELINE** are highlighted.
- 3 Press the **CURSOR RIGHT** button to display the **Parental (TV) Guidelines (TV-Y, TV-Y7, TV-G, TV-PG, TV-14, or TV-MA)**.
When highlighted, the TV-Y and TV-G can be turned **ON** (which will allow blocking), or **OFF** (which will allow viewing) of these rated programs.
- 4 The ratings of **TV-Y7, TV-PG, TV-14, TV-MA** can be customized to block **V** (violence), **FV** (fantasy violence), **S** (sexual situations), **L** (coarse language), or **D** (suggestive dialogue).
Use the **CURSOR RIGHT** or **CURSOR LEFT** buttons on the remote to turn the rating option **ON** or **OFF**.



SMART HELP



Remember: Selecting to block any rating will cause all the higher ratings to also be blocked automatically.

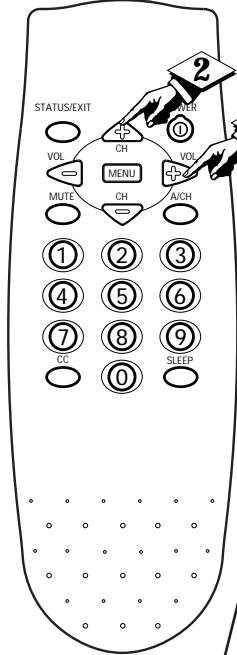
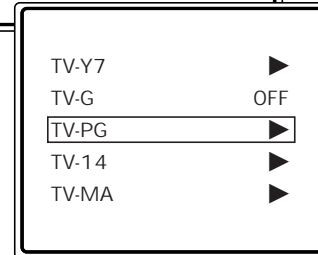
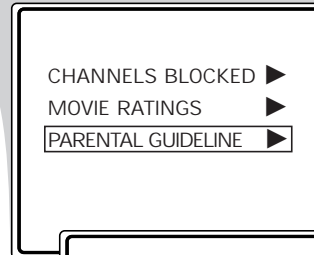
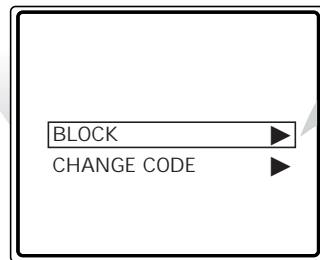

TV RATING SUB MENUS:

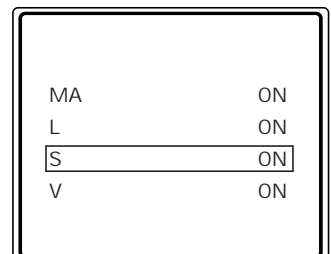
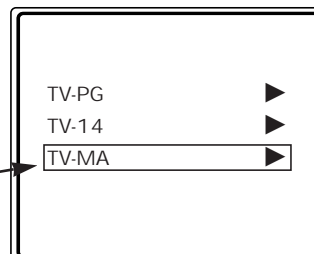
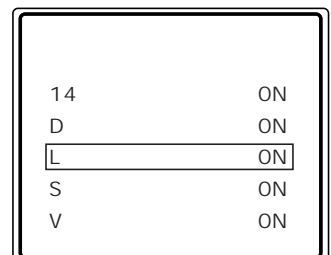
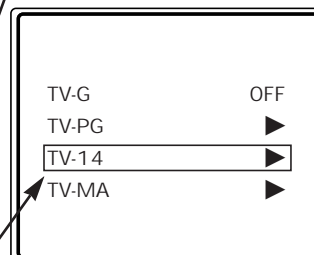
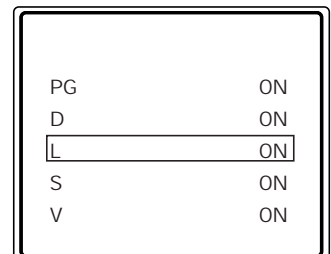
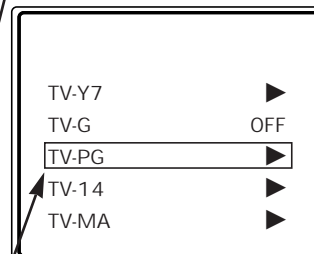
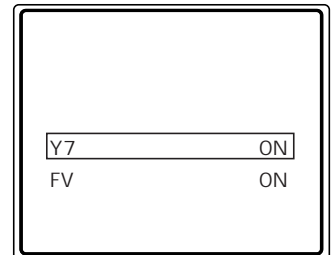
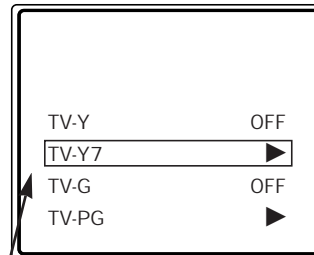

TV-Y - (All children -- This program is designed to be appropriate for all children.) Designed for a very young audience, including children ages 2-6. This type of programming is not expected to frighten younger children.

TV-Y7 - (Directed to Older Children -- This program is designed for children age 7 and above.) It may be more appropriate for children who have acquired the development skills needed to distinguish between make-believe and reality. This programming may include mild fantasy and comic violence (FV).

TV-G - (General Audience -- Most parents would find this program suitable for all ages.) This type of programming contains little or no violence, no strong language, and little or no sexual dialogue or situations.

TV-PG - (Parental Guidance Suggested -- This program contains material that parents may find unsuitable for younger children.) This type of programming contains one or more of the following: some suggestive dialogue (D), infrequent coarse language (L), some sexual situations (S), or moderate violence (V).

TV-14 - (Parents Strongly Cautioned -- This program contains some material that many parents would find unsuitable for children under 14 years of age.) This type of programming contains one or more of the following: intensely suggestive dialogue (D), strong coarse language (L), intense sexual situations (S), or intense violence (V).

TV-MA - (Mature Audience Only -- This program is specifically designed to be viewed by adults and therefore may be unsuitable for children under 17.) This type of programming contains one or more of the following: crude indecent language (L), explicit sexual situations (S), or graphic violence (V).



UNDERSTANDING THE SMARTLOCK™ CONTROL (REVIEW SCREEN)

Now that you've learned how to block channels or censor your viewing using the Movie Ratings or Parental (TV) Guidelines, let's review what you've done. The SmartLock Review feature allows you to see what has been blocked. Whenever the Menu button is pressed the onscreen menu will be displayed with the SmartLock Review highlighted.

BEGIN

1 Press the **MENU** button on the remote to show the onscreen menu. **SmartLock REVIEW** will be highlighted.

2 Press the **CURSOR RIGHT** button and the SmartLock Review Menu will appear.

This menu will display what channels have been blocked; what Movie Ratings have been blocked; what Parental (TV Ratings) Guideline have been blocked. This review screen will also display the status of Unrated and No Rating settings. If the Master Disable feature has been turned ON, the SmartLock Review screen will display "SmartLock DISABLED".

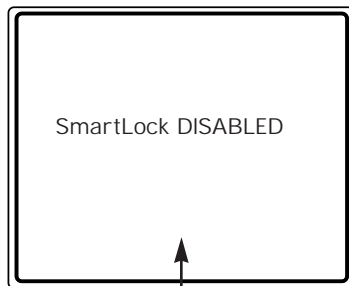
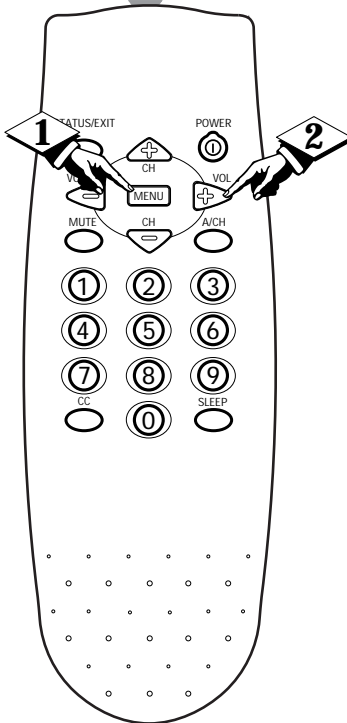
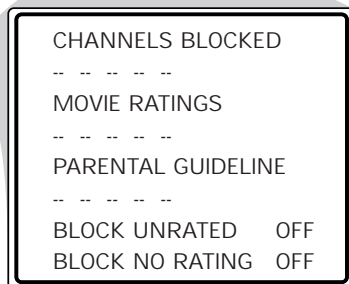
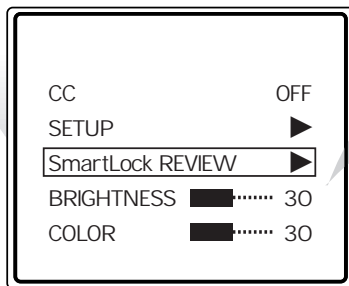

SmartLock DISABLED will appear in the SmartLock Review screen if the SmartLock Disable feature is set to ON.

CHANNELS BLOCKED - Shows all blocked channels that were set within the CHANNELS BLOCKED feature. Up to 5 channels may be blocked at one time.

MOVIE RATINGS - Shows all blocked Movie Ratings that were set within the MOVIE RATINGS feature. All or some may be blocked at one time. Note: If a lower rating is blocked; this will automatically cause the higher ratings to be blocked also. (i.e., if R is set to be blocked, X will automatically be blocked also.)

PARENTAL GUIDELINE - Shows all blocked TV Ratings that were set within the PARENTAL GUIDELINES feature. All or some may be blocked at one time. Note: If a lower rating is blocked; this will automatically cause the higher ratings to be blocked also. (i.e., if TV-14 is set to be blocked, TV-MA will automatically be blocked.) Parental Guidelines also have sub ratings for Violence (V), Fantasy Violence (FV), Sexual Situations (S), Coarse Language (L), and Suggestive Language (D). If the main rating is turned off but the sub rating is turned ON, the program will be blocked but the rating will not appear within the SmartLock Review menu.

BLOCK UNRATED - Shows ON or OFF depending on the status of the BLOCK UNRATED feature. Based on the Movie Ratings or Parental (TV) Guidelines.

BLOCK NO RATING - Shows ON or OFF depending on the status of the BLOCK NO RATING feature. Based on programming with NO content advisory data.

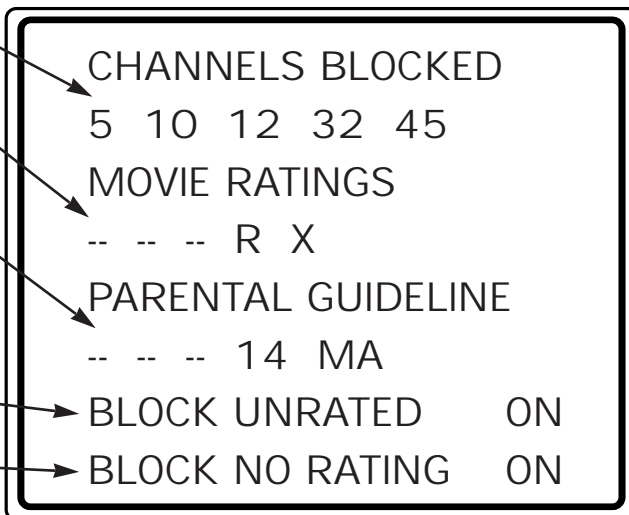



Please make these simple checks before calling for service. These tips can save you time and money since charges for TV installation and adjustment of customer controls are not covered under your warranty.

No Power

CAUTION: A video source (such as a video game, Compact Disc Interactive - CDI, or TV information channel) which shows a constant non-moving pattern on the TV screen, can cause picture tube damage. When your TV is continuously used with such a source the pattern of the non-moving portion of the game (CDI, etc.) could leave an image permanently on the picture tube. When not in use, turn the video source OFF. Regularly alternate the use of such video sources with normal TV viewing.

- Check the TV power cord. Unplug the TV, wait 10 seconds, then reinsert plug into outlet and push POWER button again.
- Check that outlet is not on a wall switch. Be sure fuse is not blown on AC Power strip.

No Picture

- Check antenna connections. Are they properly secured to the TV's 75 Ω plug?
- Check the TUNER control for CABLE or ANTENNA setting.

No Sound

- Check the VOLUME buttons.
- Check the MUTE button on the remote control.

Remote Does Not Work

- Check batteries. Replace with AAA Heavy Duty (Zinc Chloride) or Alkaline batteries if necessary.
- Clean the remote and the remote sensor window on the TV.
- Check the TV power cord. Unplug the TV, wait 10 seconds, then reinsert plug into outlet and push POWER button again. Be sure fuse is not blown on AC Power strip.
- Check to be sure TV outlet is not on a wall switch.

TV Displays Wrong Channel or No Channels Above 13

- Repeat channel selection.
- Add desired channel numbers (CHANNEL control) into TV memory.
- Check to be sure the TUNER control is set to the CABLE option.

Cleaning and Care

- To avoid possible shock hazard be sure the TV is unplugged from the electrical outlet before cleaning.
- When cleaning the TV screen take care not to scratch or damage the screen surface (avoid wearing jewelry or using anything abrasive). Wipe the front screen with a clean cloth dampened with water. Use even, easy, vertical strokes when cleaning.
- Gently wipe the cabinet surfaces with a clean cloth or sponge dampened in a solution of cool clear water. Use a clean dry cloth to dry the wiped surfaces.
- Never use thinners, insecticide sprays, or other chemicals on or near the cabinet, as they might cause permanent marring of the cabinet finish.



GLOSSARY TO TELEVISION TERMS

Coaxial Cable * A single solid antenna wire normally matched with a metal plug (F-type) end connector that screws (or pushes) directly onto a 75 Ohm input found on the Television or VCR.

Closed Caption * Broadcast standard which allows you to read the voice content of television programs on the TV screen. Designed to help the hearing impaired this feature uses onscreen "text boxes" to show dialogue and conversations while the TV program is in progress.

Direct Audio/Video Inputs * Located on the rear of the TV these connectors (RCA phono type plug) are used for the input of audio and video signals. Designed for use with VCRs (or other accessories) in order to receive higher picture resolution and offer sound connection options.

Identify* Method by which a remote control searches and finds an operating code for another product (such as a VCR or Cable Converter). Once the code has been "identified" then the TV remote can operate and send commands to the other product.

On Screen Displays (OSD) * Refers to the wording or messages generated by the television (or VCR) to help the user with specific feature controls (color adjustment, programming, etc.).

Menu * An onscreen listing of feature controls shown on the Television screen that are made available for user adjustments.

Multichannel Television Sound (MTS) * The broadcast standard that allows for stereo sound to be transmitted with the TV picture.

Programming * The procedure of adding or deleting channel numbers into the Television's memory circuits. In this way the Television "remembers" only the locally available or desired channel numbers and skips over any unwanted channel numbers.

Remote Sensor Window * A window or opening found on the Television control panel through which infrared remote control command signals are received.

Setup Mode * Automatic feature control settings made by the TV. Designed for first time setup and use. Settings for signal connections (antenna or cable TV), plus channel program memory are held in the TV's memory (even if the set is unplugged and moved to a new location.)

Second Audio Program (SAP) * Another or additional audio channel provided for in the Multichannel Television Sound (MTS) broadcast standard. The most frequently proposed use for SAP is the simultaneous bilingual broadcast of TV program material.

Status * Allows the user to quickly confirm what channel number is currently being viewed. Status can also be used to clear the Television of on screen displays or information (rather than waiting for the displays to "time out" or automatically disappear from the screen).

Twin Lead Wire * The more commonly used name for the two strand 300 Ohm antenna wire used with many indoor and outdoor antenna systems. In many cases this type of antenna wire requires an additional adapter (or balun) in order to connect to the 75 Ohm Input terminals designed into the more recent Televisions and VCRs.



Accessories/Optional5-7	Remote Control8-9
Adapter Connector	6-7	Requesting Service	30-31, 32
Add/Delete Channels	13	RF Coaxial Cable	5-7
Battery Installation	8	Safety/Precautions	3, 27, 32
Cable TV Connections/Settings	5, 11	Sensor Remote	8
Channel Memory	12, 13	Set Up/First Time Use	5-13
Closed Captioning	16	Sleep Timer	17
Controls/TV	8	SmartLock - Understanding SmartLock	20
Controls/Remote	8, 9	SmartLock Access Code Feature	21
Features	4	SmartLock Block Channel Feature	22
Glossary TV Terms	28	SmartLock Blocking Options	23
Language Option	10	SmartLock Blocking using the Movie/TV Ratings	24-25
Memory/Program Channels	12, 13	SmartLock Review	26
Menu Button	9	Status Button	9
Minus(-)/Plus (+) Buttons	9	Alternate Channel	19
Picture Controls	14	Tips for Service	27, 30-31, 32
Picture Noise Reduction	15	VCR/TV Connections	7
Precautions/Safety	3, 27, 32	Volume Bar Control	18
Programming Channels	12	Warranty	32

Philips Consumer Electronics Company Factory Service Center Locations

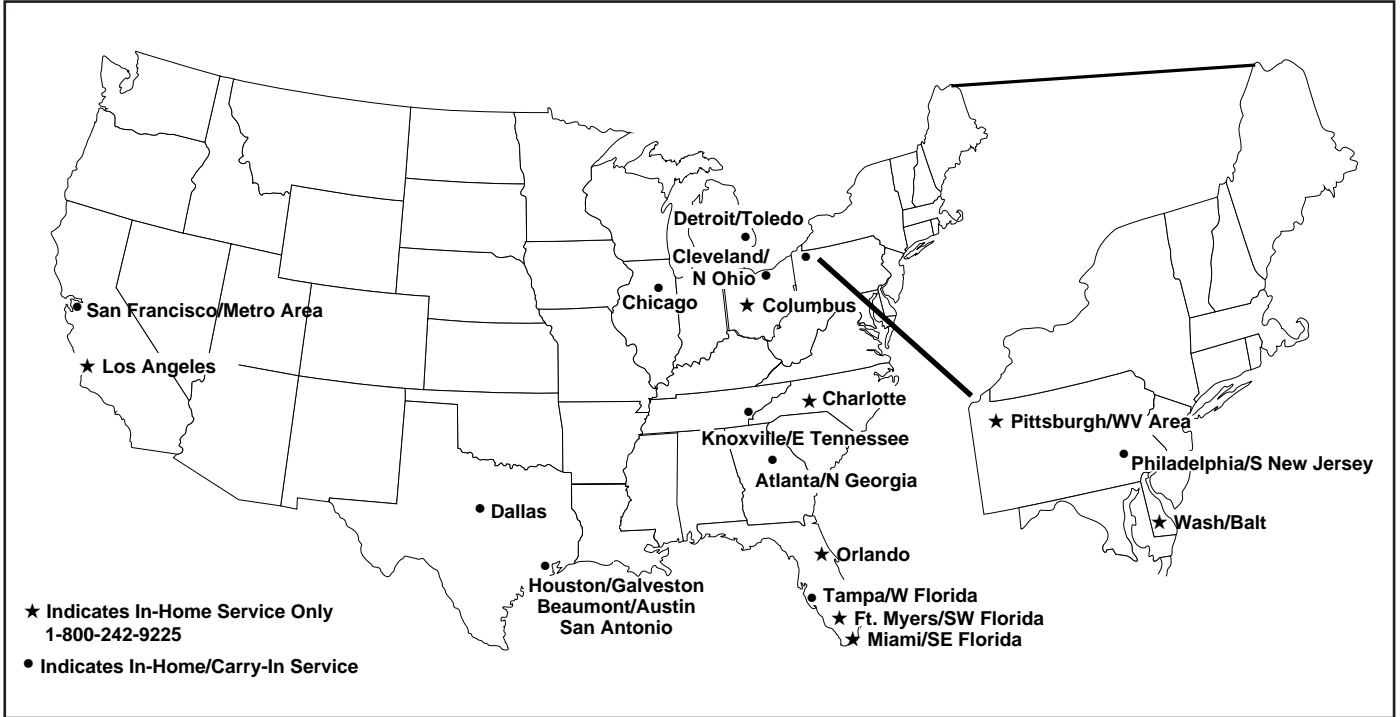

NOTE: If you reside in one of our Philips Factory Service Branch areas (see directory on back), you can contact the nearest Service Branch to obtain efficient and expedient repair for your product. If your product is In-Warranty, you should have proof-of-purchase to ensure No Charge Service. For Out-of-Warranty service, call the location nearest you.

NOTA: Si vous résidez dans une des régions desservies par une succursale de service après vente du fabricant Philips (voir liste ci-dessous), vous pourrez contacter la branche de service après vente la plus près de chez vous pour obtenir un service après vente rapide et efficace. Si le produit est sous garantie, il suffira de présenter une preuve d'achat pour bénéficier d'un service sans frais. Pour les produits non couverts par la garantie, contactez le centre le plus près de chez vous.

NOTA: Si Ud. reside en una de nuestras zonas para sucursales Philips de servicio al de fábrica (ver directorio más abajo), Ud. puede comunicarse con la sucursal de servicio más cercana para obtener una reparación oportuna y eficaz de su producto. Si su producto está todavía bajo garantía, Ud. debe presentar comprobante de compra para no ocasionar ningunos cargos por servicio. Para servicio después del vencimiento de la garantía, llame al lugar más cercano de los abajo indicados.

In Canada

How you can obtain efficient and expedient carry-in, mail-in, or in-home service for your product

Please contact Philips at

1-800-661-6162 (French speaking)

1-800-363-7278 (English speaking)

Au Canada

Comment obtenir le service après-vente pour les produits apportés ou envoyés par la poste à notre centre de service ou le service à domicile

Veuillez contacter philips à:

1-800-661-6162 (Francophone)

1-800-363-7278

En el Canadá

Cómo recibir servicio eficiente para su producto, en persona, por correo o a domicilio

Favor de comunicarse con Philips al:

1-800-661-6162 (francófono)

1-800-363-7278 (anglófono)

QUALITY SERVICE IS AS CLOSE AS YOUR TELEPHONE! SIMPLY LOOK OVER THE LIST BELOW FOR THE NUMBER OF A FACTORY SERVICE CENTER NEAR YOU. YOUR PRODUCT WILL RECEIVE EFFICIENT AND EXPEDIENT CARRY-IN, MAIL-IN, OR IN-HOME SERVICE, AND YOU WILL RECEIVE PEACE OF MIND, KNOWING YOUR PRODUCT IS BEING GIVEN THE EXPERT ATTENTION OF PHILIPS' FACTORY SERVICE. AND, IF THE PHONE NUMBER LISTED FOR YOUR AREA IS LONG DISTANCE, CALL 1-800-242-9225 FOR FACTORY SERVICE.

COMMENT OBTENIR NOTRE SERVICE APRÈS VENTE RAPIDE ET EFFICACE SOIT PAR COURRIER, À DOMICILE, OU EN SE PRÉSENTANT À UN CENTRE DE SERVICE PHILIPS. PLUS DE 600 CENTRES DE RÉCEPTION DE PRODUITS À RÉPARER À TRAVERS LE PAYS: CONTACTER LE CENTRE DE SERVICE AUX CONSOMMATEURS LE PLUS PROCHE POUR SAVOIR L'EMPLACEMENT DE CES DÉPÔTS DANS UN RAYON DE 50 À 75 MILES (80 KM À 120 KM) DU CENTRE DE SERVICE LOCAL.

CÓMO OBTENER UN SERVICIO OPORTUNO Y EFICIENTE POR CORREO, EN CASA O EN PERSONA PARA SU PRODUCTO A TRAVÉS DE UN CENTRO PHILIPS DE SERVICIO. MAS DE 600 SITIOS POR TODO EL PAIS PARA LA RECEPCION DE PRODUCTOS NECESITADOS DE REPARACIONES: COMUNICARSE CON EL CENTRO DE SERVICIO DE FABRICA MAS CERCAÑO PARA ESTOS LUGARES DENTRO DE UN RADIO DE 80 A 120 KM (50 A 75 MILLAS) DEL CENTRO DE SERVICIO LOCAL.

GEORGIA

Philips Factory Service of Georgia
200 N. Cobb Pkwy., Suite 120
Marietta, GA 30062
(770) 795-0085

FLORIDA

Philips Factory Service of Florida
1911 US Highway 301 North
Tampa, FL 33619
(813) 621-8181

WESTERN U.S.A.

Philips Factory Service Western Region
681 East Brokaw Rd.
San Jose, CA 95112
(408) 436-8566

TEXAS

Philips Factory Service of Texas
1110 N. Post Oak Rd., Suite 100
Houston, TX 77055
(713) 682-3990

CENTRAL U.S.A.

Philips Factory Service Central US
950 Keynote Circle
Brooklyn Heights, OH 44131
(216) 741-3334

MICHIGAN

Philips Factory Service of Michigan
25173 Dequindre
Madison Heights, MI 48071
(248) 544-2110

DALLAS AREA

Philips Factory Service of Dallas
415 N. Main Street, #107
Euless, TX 76040
(713) 682-3990

ILLINOIS

Philips Factory Service of Illinois
1279 W. Hamilton Pkwy.
Itasca, IL 60143
(630) 775-0990

TENNESSEE

Philips Factory Service of East Tennessee
6700 D Papermill Rd.
Knoxville, TN 37919
(423) 584-6614

MID-ATLANTIC

Philips Factory Service Mid-Atlantic
352 Dunks Ferry Rd.
Bensalem, PA 19020
(215) 638-7500

LIMITED WARRANTY

COLOR TELEVISION

90 Days Free Labor

One Year Free Replacement of Parts (Two Years Free Replacement on Color Picture Tube)

This product must be carried in for repair.

WHO IS COVERED?

You must have proof of purchase to receive warranty service. A sales receipt or other document showing that you purchased the product is considered proof of purchase.

WHAT IS COVERED?

Warranty coverage begins the day you buy your product. For 90 days thereafter, all parts will be repaired or replaced free, and labor is free. From 90 days to one year from the day of purchase, all parts will be repaired or replaced free, but you pay for all labor charges. From one to two years from the day of purchase, you pay for the replacement or repair of all parts except the picture tube, and for all labor charges. After two years from the day of purchase, you pay for the replacement or repair of all parts, and for all labor charges.

All parts, including repaired and replaced parts, are covered only for the original warranty period. When the warranty on the product expires, the warranty on all replaced and repaired parts also expires.

WHAT IS EXCLUDED?

Your warranty does not cover:

- labor charges for installation or setup of the product, adjustment of customer controls on the product, and installation or repair of antenna systems outside of the product.
- product repair and/or part replacement because of misuse, accident, unauthorized repair or other cause not within the control of Philips Consumer Electronics Company.
- reception problems caused by signal conditions or cable or antenna systems outside the unit.
- a product that requires modification or adaptation to enable it to operate in any country other than the country for which it was designed, manufactured, approved and/or authorized, or repair of products damaged by these modifications.
- incidental or consequential damages resulting from the product. (Some states do not allow the exclusion of incidental or consequential damages, so the above exclusion may not apply to you. This includes, but is not limited to, prerecorded material, whether copyrighted or not copyrighted.)
- a product used for commercial or institutional purposes.

WHERE IS SERVICE AVAILABLE?

Warranty service is available in all countries where the product is officially distributed by Philips Consumer Electronics Company. In countries where Philips Consumer Electronics Company does not distribute the product, the local Philips service organization will attempt to provide service (although there may be a delay if the appropriate spare parts and technical manual(s) are not readily available).

MAKE SURE YOU KEEP...

Please keep your sales receipt or other document showing proof of purchase. Attach it to this owner's manual and keep both nearby. Also keep the original box and packing material in case you need to return your product.

BEFORE REQUESTING SERVICE...

Please check your owner's manual before requesting service. Adjustments of the controls discussed there may save you a service call.

TO GET WARRANTY SERVICE IN U.S.A., PUERTO RICO OR U.S. VIRGIN ISLANDS...

Contact a Philips factory service center (see enclosed list) or authorized service center to arrange repair.

(In U.S.A., Puerto Rico and U.S. Virgin Islands, all implied warranties, including implied warranties of merchantability and fitness for a particular purpose, are limited in duration to the duration of this express warranty. But, because some states do not allow limitations on how long an implied warranty may last, this limitation may not apply to you.)

TO GET WARRANTY SERVICE IN CANADA...

Please contact Philips at:

1-800-894-5463

1-800-363-7278

(In Canada, this warranty is given in lieu of all other warranties. No other warranties are expressed or implied, including any implied warranties of merchantability or fitness for a particular purpose. Philips is not liable under any circumstances for any direct, indirect, special, incidental or consequential damages, howsoever incurred, even if notified of the possibility of such damages.)

REMEMBER...

Please record the model and serial numbers found on the product below. Also, please fill out and mail your warranty registration card promptly. It will be easier for us to notify you if necessary.

MODEL # _____

SERIAL # _____



This warranty gives you specific legal rights. You may have other rights which vary from state/province to state/province.

Philips Consumer Electronics Company, P.O. Box 2976, Longview, Texas 75606, (903) 242-4800