

# Always there to help you

Register your product and get support at  
[www.philips.com/welcome](http://www.philips.com/welcome)



GoGEAR

SA4VD404

SA4VD408



## User manual

**PHILIPS**





---

<b>14 Sync with PC media library through Philips Songbird</b>	<b>23</b>
Install Philips Songbird	23
Collect media files from the PC	23
Set the watch folder	23
Import media files	24
Create playlists in Philips Songbird	25
Create a playlist	25
Generate LikeMusic playlists	25
Save the play queue as a playlist	26
Manage media files in Philips Songbird	27
Edit metadata	27
Get album artwork	27
Remove media files from the library	28
Sync the player with Philips Songbird	28
Select auto or manual sync	28
Auto sync	28
Manual sync	29

---

<b>15 Update the firmware through Philips Device Manager</b>	<b>30</b>
--	-----------

---

<b>16 Troubleshooting</b>	<b>32</b>
---------------------------	-----------

---

<b>17 Technical data</b>	<b>33</b>
Supported music file formats	33
Supported video file formats	33
Supported picture file formats	33
System requirements	34

### **Need help?**

Please visit

**[www.philips.com/welcome](http://www.philips.com/welcome)**

where you can access a full set of supporting materials such as the user manual, the latest software updates, and answers to frequently asked questions.

# 1 Important safety information

## General maintenance

The translation of this document is for reference only.

In the event of any inconsistency between the English version and the translated version, the English version shall prevail.

### ! Caution

- To avoid damage or malfunction:
- Do not expose the product to excessive heat caused by heating equipment or direct sunlight.
- Do not drop the product or allow objects to fall on your player.
- Do not allow the product to be submerged in water; Do not expose headphone socket or battery compartment to water; as water entering the set may cause major damage.
- Active mobile phones in the vicinity may cause interference.
- Back up your files. Ensure that you retain the original files you have downloaded to your device. Philips is not responsible for any loss of data if the product becomes damaged or not readable / legible.
- Manage (transfer, delete, etc.) your music files only with the supplied music software to avoid problems.
- Do not use any cleaning agents containing alcohol, ammonia, benzene, or abrasives as these may harm the product.
- Batteries (battery pack or batteries installed) shall not be exposed to excessive heat such as sunshine, fire or the like.
- Danger of explosion if battery is incorrectly replaced. Replace only with the same or equivalent type.

### ☰ Note

- Batteries (battery pack or batteries installed) shall not be exposed to excessive heat such as sunshine, fire or the like.
- Danger of explosion if battery is incorrectly replaced. Replace only with the same or equivalent type.

### About operating and storage temperatures

- Operate in a place where temperature is always between 0 and 45°C (32 to 113°F)
- Store in a place where temperature is always between -20 and 45°C (-4 to 113°F).
- Battery life may be shortened in low temperature conditions.

### Replacement parts/accessories:

Visit [www.philips.com/support](http://www.philips.com/support) to order replacement parts/accessories.

### Hearing Safety



**A pleine puissance, l'écoute prolongée du baladeur peut endommager l'oreille de l'utilisateur.**



### ! Warning

- To prevent possible hearing damage, do not listen at high volume levels for long periods.

**The maximum output voltage of the player is not greater than 150 mV.**

**Wide band characteristic voltage WBCV: >= 75 mV**

### Modifications

Modifications not authorized by the manufacturer may void user's authority to operate the product.

### Copyright information

All other brands and product names are trademarks of their respective companies or organizations.

Unauthorized duplication of any recordings whether downloaded from the Internet or made from audio CDs is a violation of copyright laws and international treaties.

The making of unauthorized copies of copy-protected material, including computer programs, files, broadcasts and sound recordings, may be an infringement of copyrights and constitute a criminal offense. This equipment should not be used for such purposes.

The Windows Media and the Windows logo are registered trademarks of Microsoft Corporation in the United States and/or other countries.

**Be responsible! Respect copyrights.**



Philips respects the intellectual property of others, and we ask our users to do the same. Multimedia content on the internet may have been created and/or distributed without the original copyright owner's authorization. Copying or distributing unauthorized content may violate copyright laws in various countries including yours.

Compliance with copyright laws remains your responsibility.

The recording and transfer to the portable player of video streams downloaded to your computer is intended only for use with public domain or properly licensed content. You may only use such content for your private, non-commercial use and shall respect eventual copyright instructions provided by the copyright owner of the work. Such instruction may state that no further copies shall be made.

Video streams may include copy protection technology that prohibits further copying. For such situations the recording function will not work and you will be notified with a message.

**Data logging**

Philips is committed to improving the quality of your product and enhancing the Philips user experience. To understand the usage profile of this device, this device logs some info / data to the non-volatile memory region of the device. These data are used to identify and detect any failures or problems you as a user may experience while using the device. The data stored, for example, will be the duration of playback in music mode, duration of playback in turner mode, how many times battery low was encountered, etc. The data stored do not reveal the content or media used on the device or the source of downloads. The data stored on the device are retrieved and used **ONLY** if the user returns the device to the Philips service center and **ONLY** to simplify error detection and prevention. The data stored shall be made available to user on user's first request.

**Monkey's Audio decoder**

- ① **The Monkey's Audio SDK and source code can be freely used to add APE format playback, encoding, or tagging support to any product, free or commercial. Use of the code for proprietary efforts that don't support the official APE format require written consent of the author.**
- ② **Monkey's Audio source can be included in GPL and open-source software, although Monkey's Audio itself will not be subjected to external licensing requirements or other viral source restrictions.**
- ③ **Code changes and improvements must be contributed back to the Monkey's Audio project free from restrictions or royalties, unless exempted by express written consent of the author.**
- ④ **Any source code, ideas, or libraries used must be plainly acknowledged in the software using the code.**

- ⑤ **Although the software has been tested thoroughly, the author is in no way responsible for damages due to bugs or misuse.**

If you do not completely agree with all of the previous stipulations, you must cease using this source code and remove it from your storage device.

### FLAC decoder

Copyright (C) 2000,2001,2002,2003,2004,2005, 2006,2007,2008,2009 Josh Coalson

Redistribution and use in source and binary forms, with or without modification, are permitted provided that the following conditions are met:

- Redistributions of source code must retain the above copyright notice, this list of conditions and the following disclaimer.
- Redistributions in binary form must reproduce the above copyright notice, this list of conditions and the following disclaimer in the documentation and/or other materials provided with the distribution.
- Neither the name of the Xiph.org Foundation nor the names of its contributors may be used to endorse or promote products derived from this software without specific prior written permission.

THIS SOFTWARE IS PROVIDED BY THE COPYRIGHT HOLDERS AND CONTRIBUTORS "AS IS" AND ANY EXPRESS OR IMPLIED WARRANTIES, INCLUDING, BUT NOT LIMITED TO, THE IMPLIED WARRANTIES OF MERCHANTABILITY AND FITNESS FOR A PARTICULAR PURPOSE ARE DISCLAIMED. IN NO EVENT SHALL THE FOUNDATION OR CONTRIBUTORS BE LIABLE FOR ANY DIRECT, INDIRECT, INCIDENTAL, SPECIAL, EXEMPLARY, OR CONSEQUENTIAL DAMAGES (INCLUDING, BUT NOT LIMITED TO, PROCUREMENT OF

SUBSTITUTE GOODS OR SERVICES; LOSS OF USE, DATA, OR PROFITS; OR BUSINESS INTERRUPTION) HOWEVER CAUSED AND ON ANY THEORY OF LIABILITY, WHETHER IN CONTRACT, STRICT LIABILITY, OR TORT (INCLUDING NEGLIGENCE OR OTHERWISE) ARISING IN ANY WAY OUT OF THE USE OF THIS SOFTWARE, EVEN IF ADVISED OF THE POSSIBILITY OF SUCH DAMAGE.

---

## Recycling the product

Your product is designed and manufactured with high quality materials and components, which can be recycled and reused. When you see the crossed-out wheel bin symbol attached to a product, it means the product is covered by the European Directive 2002/96/EC:



Never dispose of your product with other household waste. Please inform yourself about the local rules on the separate collection of electrical and electronic products. The correct disposal of your old product helps prevent potentially negative consequences on the environment and human health.

### Warning

- Removal of the built-in battery invalidates the warranty and can destroy the product.
- The following removal and disposal instructions are steps that are to be performed at the end of the product's life only.

Your product contains a built-in rechargeable battery covered by the European Directive

2006/66/EC, which cannot be disposed of with normal household waste.



To safeguard the functionality and safety of your product, take your product to an official collection point or service center where a professional can remove the battery as shown:

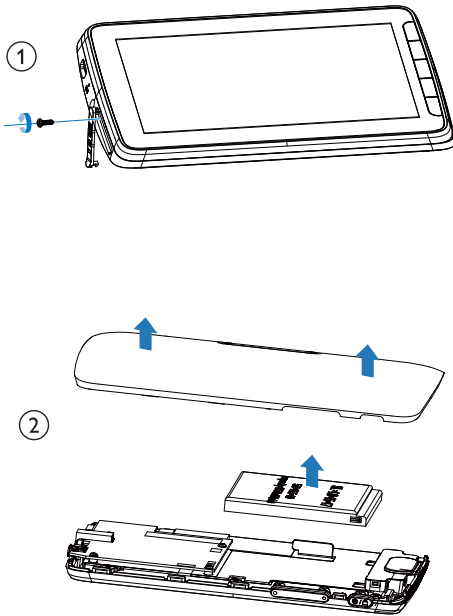

Please inform yourself about the local rules on separate collection of batteries. The correct disposal of batteries helps prevent potentially negative consequences on the environment and human health.

#### Notice for the European Union

This product complies with the radio interference requirements of the European Union.



## 2 Your new player

### What's in the box

Make sure that you have received the following items:  
Player

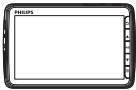

Earphones

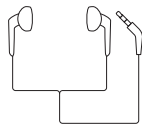

USB cable



Quick start guide



Safety and Warranty sheet



#### Note

- The images serve as reference only. Philips reserves the right to change color/design without notice.

### Software loaded on the player

VIDEO4.3 comes with the following software:

- **Philips Songbird** (helps you manage your media library on a PC and the player)
- **Philips Device Manager** (helps you get firmware updates and recover the player)

To get **Philips Songbird** and **Philips Device Manager** online,

- On your PC, download from [www.philips.com/Songbird](http://www.philips.com/Songbird) or [www.philips.com/support](http://www.philips.com/support).

### Files loaded on the player

The following files are loaded on VIDEO4.3:

- User manual
- Frequently asked questions

## Overview

### Controls

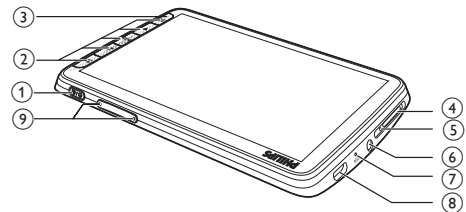

- ①
  - Press and hold: Switch on/off the device
  - Press: Lock/unlock the screen
- ②
  - Go back one level or exit
  - **on the list of options:**  
Press: Skip to the previous/next option
  - **on the play screen:**  
Press: Skip to the next/previous file  
Press and hold: Fast forward or rewind within current file



- Press: Select options, or start/pause/resume play



- Show options menu

### ③ Speaker

### ④ MICRO SD

- Slot for Micro SD card

### ⑤ RESET

- Press the hole by using the tip of a ball pen when the screen does not respond to the pressing of keys

### ⑥ 3.5 mm headphone connector

### ⑦ MIC

- Microphone

### ⑧ USB connector for power charging and data transfer

### ⑨ ◀▶

- Press: increase/decrease the volume
- Press and hold: increase/decrease fast

## Screens

### Home screen

Menu	Mode	To
	Music	play audio files
	Video	watch videos
	Pictures	view pictures
	FM radio	tune in to the FM radio
	Text reader	read text (.txt) files
	Settings	customize the settings of VIDEO4.3
	Micro SD card	view or play media files that you store on the Micro SD card
	Recordings	create or listen to recordings
	Folder view	view in folders the files that you store on the internal storage of the player

### Navigate on the screen

- From the Home screen, you can access functions or options by pressing the navigation buttons ▲, ▼ and ▶||.
- To go back to previous screens, press ◀ repeatedly.

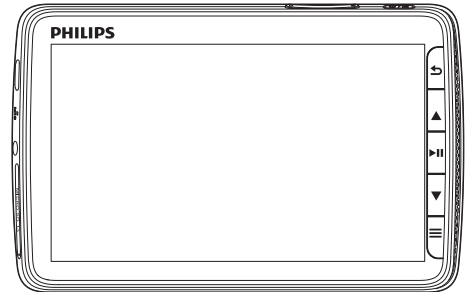

### Lock and unlock the screen

Lock the screen of VIDEO4.3. You can lock all the touch controls on the screen (the volume controls still function). Thus, undesired operations are prevented.

#### Auto lock

After a time duration, the screen dims and is locked automatically. To set the time duration, go to \* > [Display settings] > [Screen off timer].

#### To lock the screen manually

- Press ◻ / 🔒.

#### To unlock the screen

- Press ◻ / 🔓.

### Select the wallpaper

#### To select wallpaper for the Home screen,

- From the Home screen, go to \* > [Display settings] > [Wallpaper]. Select a theme.

#### To set the custom wallpaper,

- Go to . Play a picture and set the wallpaper.

#### To switch from a theme to the last custom wallpaper,

- In \* > [Display settings] > [Wallpaper], select [Custom].

---

## Volume reminder

**VIDEO4.3** can have you reminded when the volume reaches a high level. To prevent possible hearing damage, do not listen at high volume levels for long periods.

- 1 To change the volume level, press the volume button ◀, ▶ .
  - ↳ When you reach the high volume level, a beep sounds and a pop-up screen is displayed. Music play pauses.
- 2 To continue to increase the volume, press and hold ◀ until music play resumes.
  - To exit, release ◀
  - ↳ Wait until the pop-up screen disappears. Music play resumes. You return to the previous volume level.

---

## Use the stand

Use the stand at the back of the player. You can position the player in a different way.

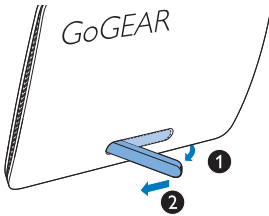

- 1 At the back of the player, lift the stand.
- 2 Push the stand to its full width.

# 3 Get started

## Charge power

VIDEO4.3 has a built-in battery that can be charged through the USB connector of a computer. Connect VIDEO4.3 to a PC by using the USB cable.

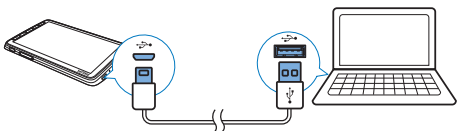

### Note

- When you connect VIDEO4.3 to a computer, you are briefly prompted to select: **[Charge & transfer]** or **[Charge & play]**. If no option is selected, **[Charge & transfer]** applies.
- To play the VIDEO4.3 when you charge power, select **[Charge & play]**.

## Battery level indication

The display indicates the approximate levels of the battery status as follows:

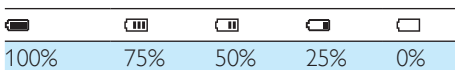

- ↳ A flashing battery screen indicates that the battery is low. The player saves all settings and switches off within 60 seconds.

### Note

- Rechargeable batteries have a limited number of charge cycles. Battery life and number of charge cycles vary by use and settings.
- The charging animation stops and the  icon is displayed when the charging process is completed.

To conserve battery power and increase the play time, do the following on VIDEO4.3:

- Set the backlight timer to a low value (go to  > **[Display settings]** > **[Screen off timer]**).

## Charge through a USB AC/DC adapter

To charge VIDEO4.3 through a USB AC/DC adapter, use **Philips AY5800** (Input: 100 - 240 V, ~50/60 Hz, 0.15 A; Output: 5.0 V, 0.5A).

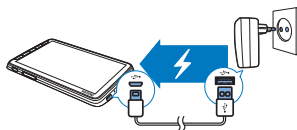

## Switch the player on or off

Press and hold  until the player is switched on or off.

## Automatic standby and shut-down

The player has an automatic standby and shut-down feature that can save battery power: If in idle mode (no play, no button is pressed) for a certain time duration, the player switches off automatically.

To define the time duration,

- From the Home screen, go to  > **[Set power-saving mode...]**.

## 4 Build a media library on VIDEO4.3

Build a media library on **VIDEO4.3** before you play from the player. To build such a media library, you can

- transfer your PC media library to the player;
- use a micro SD card (up to 32 GB) as media library.

---

### Transfer from your PC media library

You can transfer your PC media library to **VIDEO4.3** in the following ways:

- Sync through Philips Songbird (see 'Sync with PC media library through Philips Songbird' on page 23); With the media management software, you can create playlists, or edit your media collection by metadata or ID3 tag.
- Drag and drop media files in Windows Explorer.  
By doing so, you can organize your media collection by file folder:

**To drag and drop media files in Windows Explorer,**

- 1** Connect **VIDEO4.3** to a PC.
- 2** On the PC, under **My Computer** or **Computer**,
  - select **VIDEO4.3**, and create file folders.
- 3** On the PC, drag and drop media files to the file folders on **VIDEO4.3**.
  - Alternatively, drag and drop file folders from the PC to **VIDEO4.3**.

---

### Use a Micro SD card

Insert a Micro SD card (up to 32 GB) into the **VIDEO4.3**. You can expand the memory size of **VIDEO4.3**.

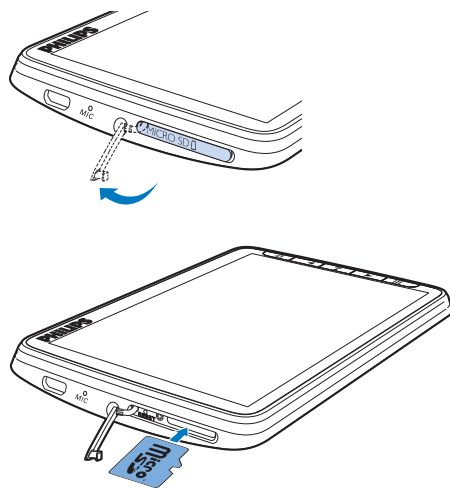

- 1** Open the cover of the Micro SD card slot.
- 2** Insert the SD card into the slot until it is fully inserted.

---

### Play from the Micro SD card

- Under **🎵**, **📺**, or **📻** on the player, you can find and play supported media files from the Micro SD card.

Alternatively,

- From the Home screen, press **🏠**. Select and play media files that are stored on the Micro SD card.







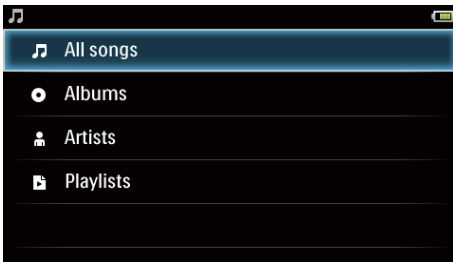

# 5 Music

Go to  to play music from the media library on the player.

## Browse the music library

In , music files are organized by meta data (file information). You can browse the music library by song information.



- 1 Press , , and  to select a library view:
  - Select , , or  to sort songs by song title, album, or artist.
    - ↳ The music library is sorted by the song information.
- 2 Press  or  to browse through the list of options. Press  to confirm your option.

## Browse by playlist

Select the library view of . You can find:







- playlists-on-the-go that you create on the player (see 'Create a playlist-on-the-go' on page 13).

## Play music



- 1 In the music library, browse to find music.
- 2 Select a song.
  - ↳ Play starts from current song.
  - ↳ The play screen is displayed.

## Select play options

On the play screen,

- Press  to pause/resume play.
- Press ,  to skip songs;  
Press and hold ,  to rewind or fast forward within current file.
- Press  to select play options:
  - [Repeat]
  - [Repeat 1]: Repeat current song.
  - [Repeat all]: Repeat all songs in current folder.
  - [Shuffle]
  - [On]: Play all songs in current folder in random order.

To switch between the play screen and library screen



- Press  repeatedly to go to the Home screen;
- To return to the play screen, select  on the Home screen. Then, select [Now playing].

## Select sound options

- On the play screen, press  to select options:

[FullSound] Restore the sonic details that music compression loses (such as MP3, WMA).

[Equalizer] Define sound settings as needed.

[Volume limit] Set a maximum volume level for the device. In this way, you can always keep the volume within a level safe enough to your hearing.  
Press ,  to set the maximum level.

 Note

- Equalizer is deactivated when you select FullSound.

---

## Playlists



With a playlist, you can access a list of songs from different artists or albums.

---

### Create a playlist-on-the-go

On **VIDEO4.3**, you can create five playlists-on-the-go.

#### Create a playlist-on-the-go

- 1 Select the library view of .
- 2 Press  and select [**Create new 'Playlist on the go'**].
  - ↳ A playlist-on-the-go is created.

#### Add songs to a playlist

- 1 Play a song.
- 2 On the play screen,
  - press  and select [**Add to playlist**].
    - ↳ A list of playlists is displayed.
- 3 Select a playlist. Confirm as prompted.
  - ↳ Current song is added to the playlist.

---

### Play a playlist

- 1 Select the library view of .
- ↳ A list of playlists is displayed.
- 2 Select a playlist and song.
  - ↳ The playlist starts playing from current song.

# 6 Videos

Go to  to play videos from the media library on the player.

---



## Browse the video library

In the video library, video files are organized by metadata (file information).

---

### Browse by title

With columns for video artwork, title and total play time, the video library of **VIDEO4.3** allows you to browse information about video files quickly.

- Press  or  to browse through the list of options. Press  to confirm your option.

---





## Play videos

- In the video library, select a video.
  - ↳ Play starts from current video.
  - ↳ The play screen is displayed.

---

### Select play options

On the play screen,

- Press  to pause/resume play.
- Press ,  to skip titles;  
Press and hold ,  to rewind or fast forward within current file.

---

### Select sound options

- On the play screen, press  to select **Surround for movies** (surround sound for movie play).

---

### Select the brightness

- On the play screen, press  and select **[Brightness]**. Select an option.



# 7 Pictures

Go to  to play pictures from the media library on the player.

---

## Browse the picture library

In the picture library, picture files are organized by album or file folder.

---

### Browse by album

- 1 Select an album or folder.
  - ↳ Pictures in the folder are displayed as thumbnails.
- 2 Press ▲ or ▼ to browse through the list of options. Press ►|| to confirm your option.

---

## Play pictures

- 1 In , select a picture to start play.
  - ↳ The play screen is displayed.
- 2 Press ▲, ▼ to select a picture.

To play pictures one by one

- Press ►||.

Alternatively,

- Press ≡ and select [Start slideshow].

---

### Select play options

On the play screen,

- Press ►|| to pause/resume play.
- Press ▲, ▼ to skip pictures.

Select slideshow settings

- On the play screen, press ≡ and select [Slideshow settings]:
  - [Slideshow effect]: Set the transition mode between two slides.
  - [Set Time per slide]: Set the time interval before one slide switches to another.

[Repeat]: Play pictures in current folder repeatedly.

[Shuffle]: Play pictures in current folder in random order.

---

## Set a picture as wallpaper

To set a picture as the wallpaper of Home screen,

- 1 Select a picture to start play.
- 2 On the play screen, press ≡ and select [Set as wallpaper].
- 3 Select [Set as wallpaper].



Tip

- You can also set the wallpaper in  > [Display settings] > [Wallpaper].

---

## Favorite pictures

With the [Favorites pictures] folder, you can access your favorite pictures from different albums.

---

### Add pictures to Favorites

- 1 Play a picture.
- 2 On the play screen, press ≡ and select [Add to 'Favorites'].
  - ↳ Current picture is added to [Favorites pictures].

---

### Remove pictures from Favorites

- 1 Play a picture.
- 2 On the play screen, press ≡ and select [Remove from 'Favorites' folder].
  - ↳ Current picture is removed from the [Favorites pictures] folder.





# 8 FM radio

## Note

- Plug in the supplied earphones when you tune in to radio stations. The earphones double as antenna. For better reception, move the earphone cable in different directions.

## Tune in to radio stations

### Auto tune

- 1 From the Home screen, go to .  
↳ The last played station starts to play.
- 2 To select a preset station, press and hold ▲ / ▼ and release.
- 3 To mute/ unmute the sound, press .  
↳  or  is displayed.

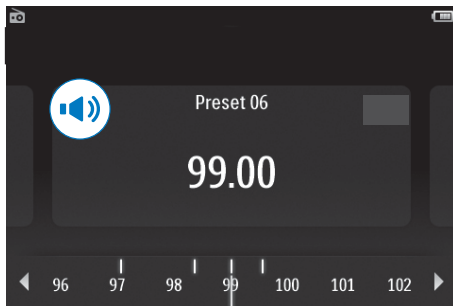

### To restart auto tune,

- On the play screen, press  and select **[Auto tune]**.  
↳ Up to 20 available stations are stored to replace the old presets.

## Tip

- When you move to a new place (such as a new city or country), restart auto tune for better reception.

## Manual tune

- Press ▲ / ▼ repeatedly to search for a frequency.

## Store preset stations

On **VIDEO4.3**, you can store up to 20 preset stations.

- 1 Tune in to a radio station.
- 2 On the radio play screen, press  and select **[Save to preset]**.  
↳ The list of preset stations is displayed.
- 3 Press ▲ / ▼ to select a preset number. Confirm as prompted.  
↳ Current station is saved to the selected location.

### To remove all preset stations,

- 1 On the radio play screen, press .
- 2 Select **[Clear all presets]**. Confirm as prompted.  
↳ All the stations are removed from the list of presets.





# 9 Recordings

## Make recordings





With **VIDEO4.3**, you can record:

- voices or audio through the built-in microphone; or
- radio programs when the radio plays on the player.

### Record voices

- 1 From the Home screen, go to . Select **[Recordings]**.  
↳ The recording screen is displayed.
- 2 Make sure that the microphone is close to the sound source.
- 3 Press  to start, pause, or resume recording. Press  to stop recording.
- 4 Select **[Yes]** to save the recording.  
↳ Recordings are saved to  > **[Voice library]** > **[Voice library]**. (Filename format: REC-00000000-XXX.MP3, where XXX is the recording number that is generated automatically.)

### Record from the FM radio

- 1 Tune in to a radio station.
- 2 On the play screen, press  and select **[Recordings]** to start recording.  
↳ You start recording from the FM radio.
- 3 Press  to toggle between pause and record.
- 4 To save the recording, press , and confirm as prompted.  
↳ Recordings are saved to  > **[Voice library]** > **[FM rec library]**. (Filename format: FMRECXXX-00000000\_XXX.MP3, where XXX is the recording number that is generated automatically.)

### Note

- The feature of FM radio recording is available with some versions only. Refer to the onscreen menu of the player to find out which features are available to you.

## Play recordings





- 1 From the Home screen, go to . Select **[Voice library]**.  
↳ In the recordings library, existing recordings are displayed.
- 2 Select a recording to start play.  
↳ The play screen is displayed.

# 10 Text reader

Go to  to play text files (.txt) from the media library on the player.

---

## Read text files



- 1 From the Home screen, go to .  
↳ The text files are displayed as a list.
- 2 Press  or  to browse through the list of options. Press  to confirm your option.  
↳ The play screen is displayed.

3 Press  ,  to turn over pages.

**To increase or decrease the font size,**

- On the play screen, press  to select **[Increase font size]** or **[Decrease font size]**.

**To add a bookmark,**

- On the play screen, press  and select **[Add bookmark]**.  
↳ Current page is folded at the  corner.

**To go to the bookmarked section,**

- On the play screen, press  and select **[Go to bookmark]**. Select an option.

**To remove a bookmark,**

- 1 Go to the bookmarked section.
- 2 Press  and select **[Delete bookmark]**.

# 11 Folder view

Go to ■ to view and play media files on the internal storage of the player.

# 12 SD Card

Go to  to view and play media files that you store on the Micro SD card.

# 13 Settings

From the Home screen, go to **⚙** to select your settings.

- Press **▲** or **▼** to browse through the list of options. Press **▶||** to confirm your option.
- Press **↵** to exit.

## Set power-saving mode

If in idle mode (no play, no button is pressed) for a certain time duration, the player switches off automatically.

- In **[Set power-saving mode...]**, select an option.
  - ↳ After the selected time duration, the device is switched off automatically.

## Sleep timer

During play or in idle mode, the **VIDEO4.3** can switch off automatically after a certain time duration.

- In **[Sleep timer]**, select an option.
  - ↳ After the selected time duration, the device is switched off automatically.

## Display settings

In **[Display settings]**, select your display options:

**[Brightness]** Select the display brightness.

**[Screen off timer]** After the selected time duration, the screen turns off automatically. To save battery power, select a low value.

**[Wallpaper]** Select a theme. Or; select **[Custom]** to switch to the custom wallpaper that you set in **⚙**.

## Language

In **[Language]**, select a language for the player.

## Information

In **[Information]**, learn the following information about the device:

**[Capacity:]** memory size

**[Free space:]** space available

**[SD card capacity:]** memory size of the SD card that is inserted into the player

**[SD card free space:]** space available on the SD card that is inserted into the player

**[Firmware version:]** current firmware version. Check the firmware version when updating firmware from the support website.

**[Model:]** full product name. Check the full product name when updating firmware from the support website.

**[CTN]** model number

**[Support site:]** web site that provides support for the device

## Format device

Format the **VIDEO4.3**. You remove all the data that are stored on the player.

- Select **[Format device]**. Then, select **[Yes]** as prompted.

---

## Factory settings

In **[Factory settings]**, restore the player to factory settings. Files transferred to the player are retained.



# 14 Sync with PC media library through Philips Songbird

With **Philips Songbird**, you can do the following:

- Manage your music collection on a PC;
- Sync **VIDEO4.3** with your PC music library;
- Register **VIDEO4.3** on [www.philips.com/welcome](http://www.philips.com/welcome).

## Install Philips Songbird

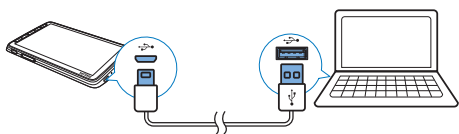

- 1 Connect **VIDEO4.3** to a PC.
- 2 On the PC, select **My Computer** (Windows XP / Windows 2000) / **Computer** (Windows Vista / Windows 7).
- 3 Right click on the **Philips GoGear VIDEO4.3** icon. Select **Download Philips Songbird**.
  - Alternatively, click the **Philips GoGear VIDEO4.3** icon. Double click the **setup.exe**.
- 4 Follow the onscreen instructions to complete the installation.

### Note

- The installation requires you to agree to the license terms.

## Collect media files from the PC

### Set the watch folder

#### Create a central folder

You can have all music files automatically added to your library when you copy them to a folder. Creating a central folder is recommended. In

**Philips Songbird**, set the central folder as the watch folder. Each time you launch **Philips Songbird**, songs are added to/ removed from **Philips Songbird** as they are on the central folder.

On the PC, create a central folder to save all music files, for example, D:\Songbird media.

#### First-time launch

The first time you launch **Philips Songbird** on a PC, do the following as prompted to import existing media files into **Philips Songbird**:

- Select the iTunes media folder to import an existing iTunes library;
- Select the central folder to search and import the existing music files.
  - ↳ The central folder is set as the watch folder of **Philips Songbird**.

#### Set iTunes media folder

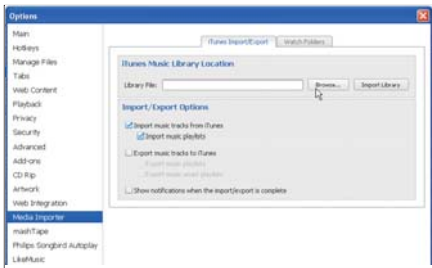
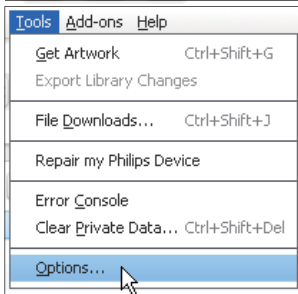

- 1 On Philips Songbird, go to **Tools > Options...**
- 2 Select **Media Importer**, and then the **iTunes Importer** tab.
- 3 Verify your library location and options.
- 4 Click the **Import Library** button next to the library location.
  - ↳ The software imports the iTunes library into **Philips Songbird**.

### Set the watch folder

In **Philips Songbird**, set the watch folder as follows:

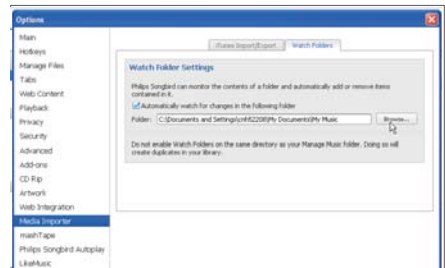
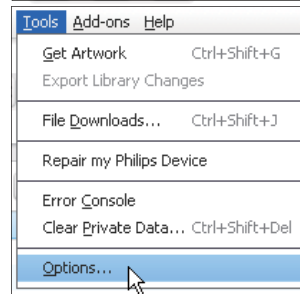

- 1 Select **Tools > Options**.
- 2 In **Options**, select **Media Importer**. Then, select the **Watch Folders** tab.
- 3 In **Watch Folders**, tick the check box as shown.
- 4 Click **Browse**, and select the central folder (e.g. D:\Songbird media) as the watch folder.
  - ↳ In **Philips Songbird**, media files are added or removed as they are in the central music folder.

## Import media files

Import media files from other folders  
In **Philips Songbird**,

- go to **File > Import Media** to select folders on the PC.
  - ↳ Media files are added under **Library**.

- or, go to **File > Import a playlist** to select playlists on the PC.
  - ↳ Media files are added under **Playlists**.

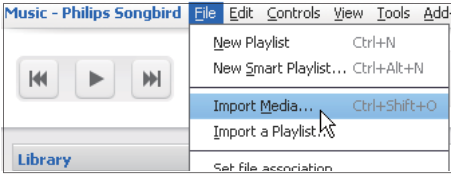

## Create playlists in Philips Songbird

With a playlist, you can manage and sync your songs as needed.

### Create a playlist

Select songs that you want to play. Add the songs to a playlist.

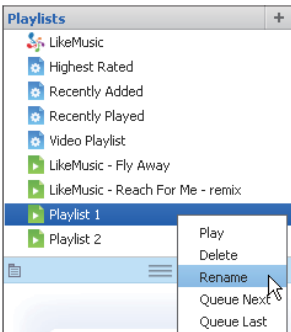
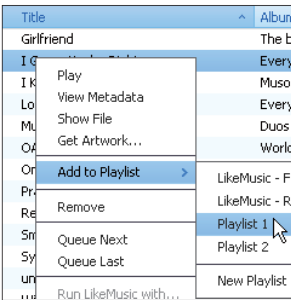

- 1 In **Library > Music**, select songs.
  - To select multiple songs, hold down the **Ctrl** button when you click songs.
- 2 To add the songs to a playlist:
  - Right click on the songs, and select **Add to Playlist**;
  - Select a playlist;
    - ↳ The songs are added to the playlist.
  - To create a playlist, select **New Playlist**.
    - ↳ A new playlist is created for the songs.
    - ↳ Under **Playlists**, name the playlist as needed.

Alternatively,  
Create a playlist. Add selected songs to the playlist.

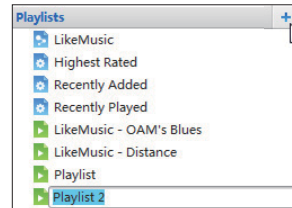

- 1 Under **Playlists**, click **+** to create a playlist.
  - ↳ A new playlist is created.
- 2 Name the new playlist as desired.
- 3 Drag and drop media files to the playlist.

### Tip

- To drag and drop multiple files at the same time, hold down the **Ctrl** button when you click on selections.

## Generate LikeMusic playlists

Based on the **LikeMusic** analysis, a playlist can be generated from a seed song.

LikeMusic analyzes songs in your library and, based on their music characteristics, creates relationships between them. These relationships help LikeMusic to create playlists of songs that sound great together.

When you import songs into the music library of Philips Songbird, the LikeMusic analysis starts. For the song that completes the analysis, the LikeMusic icon lights up; For the song that cannot complete the analysis, the icon remains gray.



### Select a seed song

Make sure that the seed song has completed the LikeMusic analysis.

- In **Library > Music**, double click the blue LikeMusic icon of the song;

Alternatively,

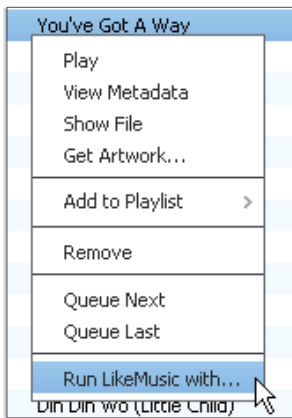

- In **Library > Music**, right click on a song and select **Run LikeMusic with...**  
 ↳ A LikeMusic playlist is displayed in the LikeMusic page.

### Set the maximum number of songs

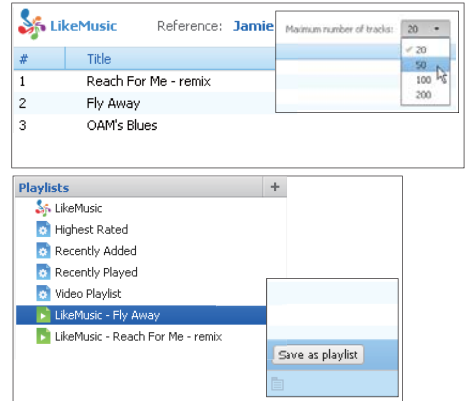

- Select a number in the drop-down list.

### Save the LikeMusic playlist

- Click **Save as playlist** in the LikeMusic page.  
 ↳ The LikeMusic playlist is saved under **Playlists**.

### Save the play queue as a playlist

#### Create a play queue

- Drag and drop songs or playlists to the **Play Queue** pane.

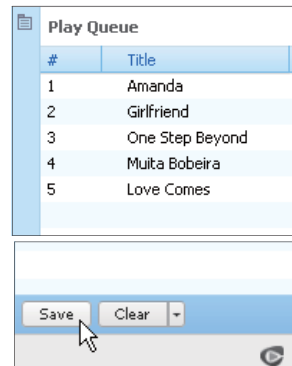

### Save the play queue as a playlist

- 1 Click **Save**.  
 ↳ The play queue is saved as a playlist under **Playlists**.

2 Under **Playlists**, name the playlist as needed.

**Add songs to the top or end of the play queue**

- To add songs to the top, right click on the options and select **Queue Next**;
- To add songs to the end, right click on the options and select **Queue Last**.

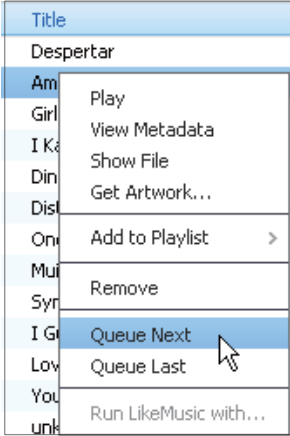

## Manage media files in Philips Songbird

### Edit metadata

By editing file information (metadata or ID3 tag), you can have media files sorted automatically by song title, artist, album, and other information.

After you sync the media files to the player, you can browse the media library by metadata.

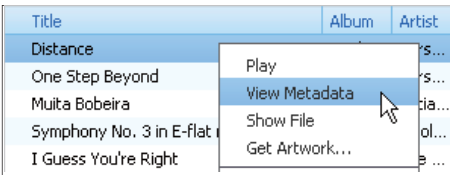

1 In **Library > Music** or **Videos**, select a media file.

2 Right click on the file to select **View Metadata**.

↳ A metadata table appears for you to edit the information.

### Get album artwork

Artwork is sometimes available for music downloads. With **Philips Songbird**, you can insert artwork for songs.

After you sync the songs to some players, you can browse the media library by artwork.

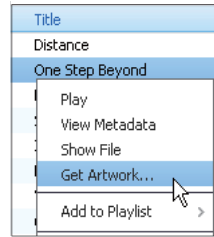
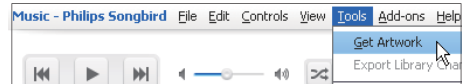

- On **Philips Songbird**, select **Tools > Get Artwork**.  
↳ Artwork is fetched for all titles in the library.
- Right click on selected titles, and select **Get Artwork**.  
↳ Artwork is fetched for all selected titles.

## Remove media files from the library

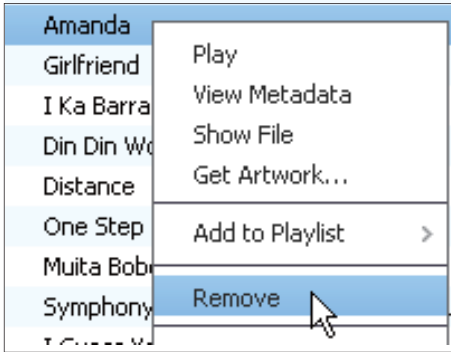

- 1 Right click on a media file. Select **Remove**.
- 2 Confirm as prompted.
  - ↳ The selected file is removed from the library and from all playlists. (By default, the file is only "removed", not "deleted". The file still exists in its original location on the computer or computer network.)

### Tip

- To select multiple files, hold down the **Ctrl** button when you click on selections.
- To select multiple consecutive files, hold down the **Shift** button when you click on the first and last selections.

## Sync the player with Philips Songbird

- 1 On the PC, launch **Philips Songbird**.
- 2 Connect the player to the PC by using a USB cable.
  - ↳ On **Philips Songbird**, the player is displayed when it is recognized by the PC.

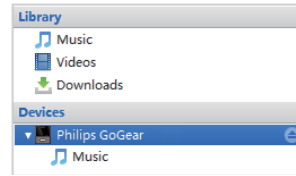
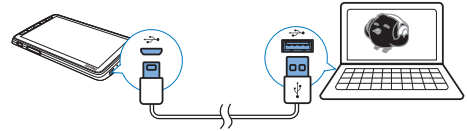

## Select auto or manual sync

The first time you connect the player to **Philips Songbird**, select auto sync as prompted. The player sync with **Philips Songbird** automatically. If you didn't select auto sync, you switch on the manual sync.

To select auto or manual sync,

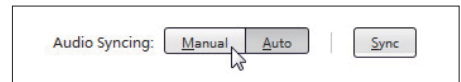
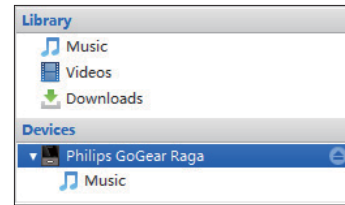

- 1 Select the player under **Devices**.
- 2 Select **Manual** or **Auto**.
- 3 To confirm the option, click **Apply**.

## Auto sync

- If you have selected auto sync, auto sync starts automatically when you connect the player to a PC;

- Alternatively, select the player under **Devices**, and click **Sync**.

To select auto sync settings,

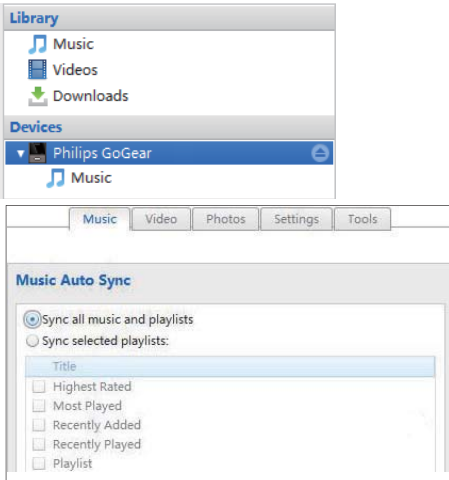

- 1 Select the player under **Devices**.
- 2 On the pop-up window, click the **Music** or **Videos** tab.
- 3 Click to select an option.

## Manual sync

To manually transfer selected playlists,

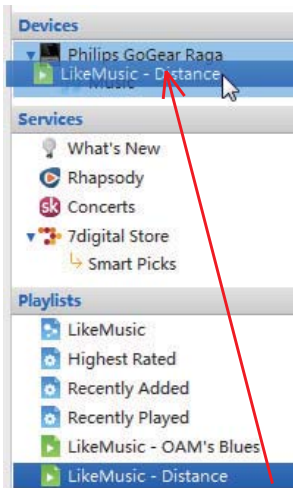

- 1 Select playlists.
  - 2 Drag and drop the playlists to **VIDEO4.3**.
- To manually transfer selected media files,



- 1 On the Content pane, right click on a selected media file.
- 2 Select **Add to Device > VIDEO4.3**.  
↳ Selected files are transferred to **VIDEO4.3**.



Tip

- To select multiple files at the same time, hold down the **Ctrl** button when you click on selections.

# 15 Update the firmware through Philips Device Manager

## Install Philips Device Manager

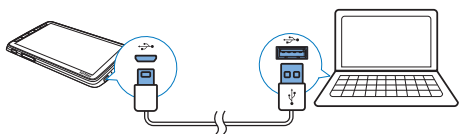

- 1 Connect **VIDEO4.3** to a PC.
- 2 On the PC, select **My Computer** (Windows XP / Windows 2000) / **Computer** (Windows Vista / Windows 7).
- 3 Right click on the **Philips GoGear VIDEO4.3** icon. Select **Install Philips Device Manager**.
  - Alternatively, click the **Philips GoGear VIDEO4.3** icon. Double-click the **installer.exe**.
- 4 Follow the onscreen instructions to complete the installation of the software.

### Note

- The installation requires you to agree to the license terms.

## Check for firmware updates

- 1 Make sure that you have connected your PC to the Internet.
- 2 Launch **Philips Device Manager**.  
↳ A dialog box is displayed.
- 3 Connect **VIDEO4.3** to your PC.  
↳ When the device is connected, "SA4VD4XX" is displayed on the text box.

↳ You can find current firmware version of the device.



- 4 To check for firmware updates,
  - ① Close the dialog box of Philips Device Manager.
  - ② At the base of the PC screen, right click  and select **Check for updates**.

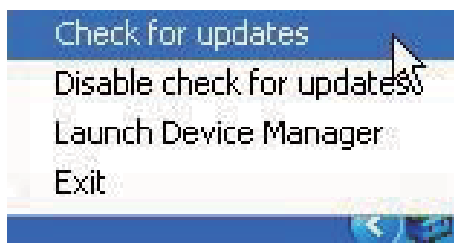

↳ **Philips SA4VD4XX Device Manager** checks for updates from the Internet.

## Update the firmware

- 1 When the firmware update is available, follow the onscreen instructions to download and install the firmware.
- 2 Disconnect **VIDEO4.3** from the PC.



↳ **VIDEO4.3** restarts after the firmware is updated and is ready for use again,

# 16 Troubleshooting

If **VIDEO4.3** is not working properly or the display freezes, you can reset it without losing data:

## How do I reset VIDEO4.3?

- Insert a pen tip or other object into the reset hole on **VIDEO4.3**. Hold until the player shuts down.
- If the reset option is unsuccessful, recover **VIDEO4.3** through **Philips Device Manager**:

- 1** On your PC, launch **Philips Device Manager**.
- 2** Enter the recovery mode:
  - ①** Switch off **VIDEO4.3**.
  - ②** Press and hold the volume button , and then, connect **VIDEO4.3** to your PC.
  - ③** Keep holding the button until **Philips Device Manager** recognizes **VIDEO4.3** and enters the recovery mode.
- 3** Start the recovery process:
  - ①** On **Philips Device Manager**, click the **Repair** button. Follow the onscreen instructions to complete the recovery process.
  - ②** When the recovery is completed, disconnect **VIDEO4.3** from your PC.
- 4** Restart **VIDEO4.3**.

# 17 Technical data

## Power

- Power supply: 1050 mAh Li-ion polymer internal rechargeable battery
- Play time<sup>1</sup>  
Music: up to 20 hours  
Video: up to 4 hours  
Radio: up to 25 hours

## Software

- **Philips Songbird:** To transfer<sup>3</sup> media
- **Philips Device Manager:** To update the firmware and recover the player

## Connectivity

- Headphone 3.5 mm
- USB 2.0 High speed

## Sound

Headphone:

- Channel separation: >35 dB
- Frequency Response: 45 Hz - 16 kHz
- Output power (RMS): 2 x 2.4 mW
- Signal to noise ratio: > 80 dB

## Audio playback

- MP3 bit rates: 8 - 320 kps and VBR
- MP3 sample rates: 8, 11.025, 16, 22.050, 24, 32, 44.1, 48 kHz
- WMA bit rates: 5 - 192 kbps and VBR
- WMA sample rates: 8, 11.025, 16, 22.050, 32, 44.1, 48 kHz
- ID3-tag support

## Video playback

- MPEG4 SP: Up to 2 Mbps, 720 x 560 pixels, 25 fps
- MP4 (AVI)/ MPEG4 AVC/ H.264: up to 4 Mbps in .avi/.mp4, 720 x 576 pixels, 25 fps
- RMVB: up to 2 Mbps, 1280 x 720 pixels, 25 fps
- WMV9: Up to 1 Mbps, 640 x 480 pixels, 25 fps

## Storage media

- Built-in memory capacity<sup>2</sup>: SA4VD4 4 GB NAND Flash , SA4VD4 8GB NAND Flash

## Media transfer<sup>3</sup>

- Songbird (sync)
- Windows Explorer (drag and drop)

## Display

- Touch-sensitive color LCD
- 480 x 272 pixels
- 262 k colors

## Note

- Specifications are subject to change without notice.
- <sup>1</sup> Rechargeable batteries have a limited number of charge cycles. Battery life and number of charge cycles vary by use and settings.
- <sup>2</sup> 1GB = 1 billion bytes; available storage capacity is less. Full memory capacity may not be available as some memory is reserved for the player. Storage capacity is based on 4 minutes per song and 128 kbps MP3 encoding.
- <sup>3</sup> Transfer speed depends on operating system and software configuration.

## Supported music file formats

VIDEO4.3 supports the following music formats:

- MP3
- WMA
- WAV
- Flac
- Ape

## Supported video file formats

VIDEO4.3 supports the following video formats:

- MPEG4 SP
- MP4 (AVI)/ MPEG4 AVC/ H.264
- RMVB

## Supported picture file formats

VIDEO4.3 supports the following picture formats:

- JPEG

- BMP

---

## System requirements

- Windows® XP (SP3 or above) / Vista / 7
- Pentium III 800 MHz processor or higher
- 512 MB RAM
- 500 MB hard disk space
- Internet connection
- Windows® Internet Explorer 6.0 or later
- CD-ROM drive
- USB port



