

User Manual

22HFL5662H

26HFL5662H

32HFL4462F

32HFL5662D

32HFL5662H

32HFL5662L

37HFL4482F

37HFL5682D

37HFL5682L

42HFL4482F

42HFL5682D

42HFL5682H

42HFL5682L

PHILIPS

Contents

1	Notice	1
	Safety information and useful tips	1
	Important Safety Instructions	2
	OSS declaration	3
	Cleaning and care	3
	Environmental care	4

2	Your TV	5
	Standalone installation and side controls	5
	Guest remote control (optional)	6
	Philips Hospitality setup remote control (not included in box)	7
	RC2573GR setup remote control (not included in box)	7

3	Installation	8
	Smart Installation	8
	Install TV Channels	9

4	Home Screen	13
	Watch TV	13
	Smart Features	13
	USB	14
	TV Settings in Guest Menu	14

5	Option	16
----------	---------------	-----------

6	Hotel Setting	17
	Hotel and Room Information	17
	Channel Map Setup	17
	Guest TV Settings	18
	PPV/VOD Options	19
	Installer TV Settings	21
	SmartClone	23
	TV Upgrade	24

7	Overview of TV connectors and controls	26
----------	---	-----------

8	Glossary	28
----------	-----------------	-----------

1 Notice

Know these

safety symbols



This “bolt of lightning” indicates uninsulated material within your unit may cause an electrical shock. For the safety of everyone in your household, please do not remove product covering.



The “exclamation point” calls attention to features for which you should read the enclosed literature closely to prevent operating and maintenance problems.

WARNING: To reduce the risk of fire or electric shock, this apparatus should not be exposed to rain or moisture and objects filled with liquids, such as vases, should not be placed on this apparatus.

CAUTION: To prevent electric shock, match wide blade of plug to wide slot, fully insert.

ATTENTION: Pour éviter les choc électriques, introduire la lame la plus large de la fiche dans la borne correspondante de la prise et pousser jusqu’au fond.

Healthcare TV models

(22HFL5662H, 26HFL5662H, 32HFL5662H, 42HFL5682H)

Class 1 Warning

WARNING

THIS TELEVISION IS CONSIDERED TO BE A DEVICE WITH CLASS 1 CONSTRUCTION AND IT SHALL BE CONNECTED TO A MAINS SOCKET OUTLET WITH A PROTECTIVE EARTHING CONNECTION.

Pendant control Instruction manual Marking

CAUTION

INSTALLER: THIS PRODUCT IS NOT PROVIDED WITH A PENDANT CONTROL; HOWEVER, IT IS EXPECTED THAT THIS INSTITUTION (OR HOSPITAL) WILL PROVIDE ONE FOR ATTACHMENT TO THE APPROPRIATE RECEPTACLE ON THE PRODUCT. AS PART OF THE INSTALLATION, EXAMINE THE PENDANT CONTROL TO DETERMINE WHETHER A MARKING SIMILAR TO THE ONE BELOW APPEARS ON IT: ‘CAUTION – RISK OF FIRE IF USED IN OXYGEN ENRICHED ATMOSPHERE – RETURN TO HOOK OR HOLDER AFTER USE.’ IF THE ABOVE NOTICE IS NOT PROVIDED ON THE PENDANT CONTROL, REMOVE THE LABEL PROVIDED WITH THESE INSTRUCTIONS AND ATTACH IT TO THE PENDANT CONTROL.

Safety information and useful tips

1. Two people are required to lift and carry a TV that weighs more than 55 lb (25 kg). Improper handling of the TV can cause serious injury.
 2. If you place the TV set on a solid surface. Ensure the surface is level and that it can withstand the weight of the TV.
 3. Installing the TV on the wall requires special skill that should only be performed by a qualified personnel. You should not attempt to do the work yourself. Philips bears no responsibility for improper mounting or mounting that results in accident or injury. Make sure that the wall mount is being fixed securely enough so that it meets safety standards.
 4. This TV is compatible with the VESA wall mounting standard. Please contact your local electronics supplier for a VESA compliant bracket to wall mount this TV. Before you mount your TV on a wall, ensure the wall is suitable to carry the weight of the TV.
 5. Do not insert the power plug in the wall socket before all connections are made.
 6. Do not touch any part of the TV, power lead, or aerial lead during lightning storms.
 7. Do not leave the TV in stand-by mode for an extended period of time. Instead, disconnect the TV from the mains.
 8. The TV set is always connected to the mains. Disconnection of the TV set can be done by:
 - unplugging the mains cord located at the back of TV set, or
 - unplugging the mains plug from the mains socket outlet.
-  Pull the power lead by the plug - do not pull by the wire.
9. Ensure the power cord is fully inserted into the TV mains socket and the wall socket.
 10. If the TV is mounted on a swivel base or swivel arm, ensure no strain is placed on the power cord when the TV is swivelled. Strain on the power cord can loosen connections and cause arcing or fire.
 11. Verify that the mains supply voltage in your location corresponds to the voltage printed on the sticker at the rear of the TV.
 12. The mains plug or appliance coupler is used as the disconnect device, the disconnect device shall remain readily operable.
 13. An all-pole MAINS SWITCH is used as the disconnect device, the location on the apparatus and the function of the switch shall be described, and the switch shall remain readily operable.

Important Safety Instructions

Read before operating equipment

1. Read these instructions.
2. Keep these instructions.
3. Heed all warnings.
4. Follow all instructions.
5. Do not use this apparatus near water.
6. Clean only with a dry cloth.
7. Do not block any ventilation openings. Install in accordance with the manufacturer's instructions.
8. Do not install near any heat sources such as radiators, heat registers, stoves, or other apparatus (including amplifiers) that produce heat.
9. Do not defeat the safety purpose of the polarized or grounding-type plug. A polarized plug has two blades with one wider than the other. A grounding type plug has two blades and a third grounding prong. The wide blade or the third prong are provided for your safety. If the provided plug does not fit into your outlet, consult an electrician for replacement of the obsolete outlet.
10. Protect the power cord from being walked on or pinched particularly at plugs, convenience receptacles, and the point where they exit from the apparatus.
11. Only use attachments/accessories specified by the manufacturer.
12. Use only with a cart, stand, tripod, bracket, or table specified by the manufacturer; or sold with the apparatus. When a cart is used, use caution when moving the cart/apparatus combination to avoid injury from tip-over.
13. Unplug this apparatus during lightning storms or when unused for long periods of time.
14. Refer all servicing to qualified service personnel. Servicing is required when the apparatus has been damaged in any way, such as power-supply cord or plug is damaged, liquid has been spilled or objects have fallen into the apparatus, the apparatus has been exposed to rain or moisture, does not operate normally, or has been dropped.
15. This product may contain lead or mercury. Disposal of these materials may be regulated due to environmental considerations. For disposal or recycling information, please contact your local authorities or the Electronic Industries Alliance: www.eiae.org.
16. **Damage Requiring Service** - The appliance should be serviced by qualified service personnel when:
 - A. The power supply cord or the plug has been damaged; or
 - B. Objects have fallen, or liquid has been spilled into the appliance; or
 - C. The appliance has been exposed to rain; or
 - D. The appliance does not appear to operate normally or exhibits a marked change in performance; or
 - E. The appliance has been dropped, or the enclosure damaged.



17. **Tilt / Stability** - All televisions must comply with recommended international global safety standards for tilt and stability properties of its cabinet design.
 - Do not compromise these design standards by applying excessive pull force to the front, or top, of the cabinet which could ultimately overturn the product.
 - Also, do not endanger yourself, or children, by placing electronic equipment/toys on the top of the cabinet. Such items could unsuspectingly fall from the top of the set and cause product damage and / or personal injury.
18. **Wall or Ceiling Mounting** - The appliance should be mounted to a wall or ceiling only as recommended by the manufacturer. For use only with VESA Wall Mount Bracket.
19. **Power Lines** - An outdoor antenna should be located away from power lines.
20. **Outdoor Antenna Grounding** - If an outside antenna is connected to the receiver, be sure the antenna system is grounded so as to provide some protection against voltage surges and built up static charges. Section 810 of the National Electric Code, ANSI/NFPA No. 70-1984, provides information with respect to proper grounding of the masts and supporting structure grounding of the lead-in wire to an antenna-discharge unit, size of grounding connectors, location of antenna-discharge unit, connection to grounding electrodes and requirements for the grounding electrode. See Figure below.
21. **Object and Liquid Entry** - Care should be taken so that objects do not fall and liquids are not spilled into the enclosure through openings.
Warning: To reduce the risk of fire or electric shock, this apparatus should not be exposed to rain or moisture and objects filled with liquids, such as vases should not be placed on this apparatus.
22. **Battery Usage CAUTION** - To prevent battery leakage that may result in bodily injury, property damage, or damage to the unit:
 - Install all batteries correctly, with + and - alignment as marked on the unit.
 - Do not mix batteries (old and new or carbon and alkaline, etc.).
 - Remove batteries when the unit is not used for a long time.
 - The batteries (batteries installed) shall not be exposed to excessive heat such as sunshine, fire or the like.
23. **CAUTION** - These servicing instructions are for use by qualified service personnel only. To reduce the risk of electric shock, do not perform any servicing other than that contained in the operating instructions unless you are qualified to do so.

LAMP(S) INSIDE THIS PRODUCT CONTAIN MERCURY AND MUST BE RECYCLED OR DISPOSED OF ACCORDING TO LOCAL, STATE OR FEDERAL LAWS.

EXAMPLE OF ANTENNA GROUNDING AS PER NATIONAL ELECTRICAL CODE (NEC)

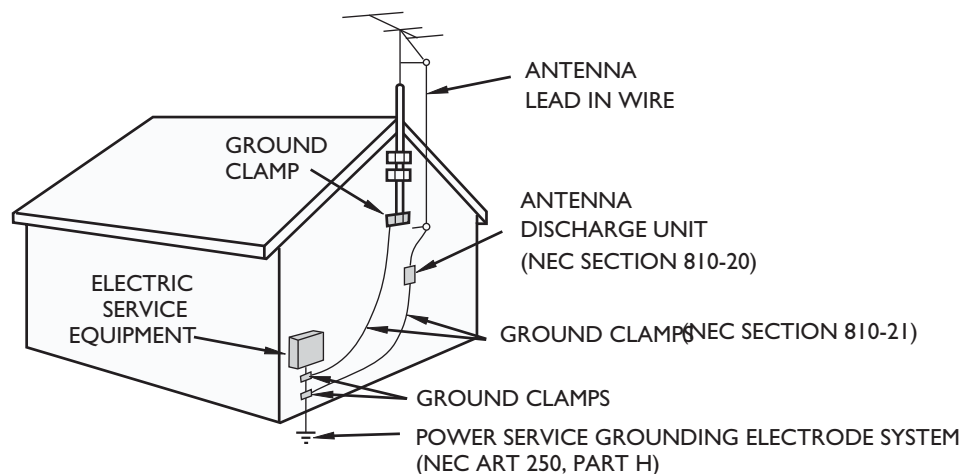

Note to the CATV system installer: This reminder is provided to call the CATV system installer's attention to Article 820-40 of the NEC that provides guidelines for proper grounding and, in particular, specifies that the cable ground shall be connected to the grounding system of the building, as close to the point of cable entry as practical.

2010 © Koninklijke Philips Electronics N.V. All rights reserved.

Specifications are subject to change without notice. Trademarks are the property of Koninklijke Philips Electronics N.V or their respective owners. Philips reserves the right to change products at any time without being obliged to adjust earlier supplies accordingly.

The material in this manual is believed adequate for the intended use of the system. If the product, or its individual modules or procedures, are used for purposes other than those specified herein, confirmation of their validity and suitability must be obtained. Philips warrants that the material itself does not infringe any United States patents. No further warranty is expressed or implied.

Philips can't be held responsible neither for any errors in the content of this document nor for any problems as a result of the content in this document.

Errors reported to Philips will be adapted and published on the Philips support website as soon as possible.

Warranty

No components are user-serviceable. Do not open or remove covers to the inside of the product.

Repairs may only be done by Philips Service Centers and official repair shops. Failure to do so shall void any warranty, stated or implied. Any operation expressly prohibited in this manual, any adjustments, or assembly procedures not recommended or authorised in this manual shall void the warranty.

Pixel characteristics

This LCD product has a high number of colour pixels. Although it has effective pixels of 99.999% or more, black dots or bright points of light (red, green or blue) may appear constantly on the screen. This is a structural property of the display (within common industry standards) and is not a malfunction.

OSS declaration

Open source software

This television contains open source software. Philips BU Hospitality hereby offers to deliver or make available, upon request, for a charge no more than the cost of physically performing source distribution, a complete machine-readable copy of the corresponding source code on a medium customarily used for software interchange.

To obtain the source code, write to:

Philips Singapore Pte Ltd.
Philips BU Hospitality
Software Development Manager
620A Lorong 1, Toa Payoh
Singapore 319762

This offer is valid for three years after the date of purchase of this product.

Federal Communications Commission Notice

This equipment has been tested and found to comply with the limits for a Class B digital device, pursuant to part 15 of the FCC Rules. These limits are designed to provide reasonable protection against harmful interference in a residential installation. This equipment generates, uses, and can radiate radio frequency energy and, if not installed and used in accordance with the instructions, may cause harmful interference to radio communications. However, there is no guarantee that interference will not occur in a particular installation. If this equipment does cause harmful interference to radio or television reception, which can be determined by turning the equipment off and on, the user is encouraged to try to correct the interference by one or more of the following measures:

- Reorient or relocate the receiving antenna.
- Increase the separation between the equipment and the receiver.
- Connect the equipment into an outlet on a circuit different from that to which the receiver is connected.
- Consult the dealer or an experienced radio or television technician for help.

Modifications

The FCC requires the user to be notified that any changes or modifications made to this device that are not expressly approved by Philips Consumer Electronics may void the user's authority to operate the equipment.

Cables

Connections to this device must be made with shielded cables with metallic RFI/EMI connector hoods to maintain compliance with FCC Rules and Regulations.

Canadian notice

This Class B digital apparatus meets all requirements of the Canadian Interference-Causing Equipment Regulations.

Avis Canadien

Cet appareil numérique de la classe B respecte toutes les exigences du Règlement sur le matériel brouilleur du Canada.

Cleaning and care

- Do not touch the screen with anything hard as this may scratch, mark or damage the screen permanently.
- Do not rub with dust clothes containing chemical treatment.
- Do not touch the surface with bare hands or a greasy cloth (some cosmetics are harmful to the screen).
- Unplug the TV before cleaning the screen.
- When the surface becomes dusty, wipe gently with absorbent cotton or other soft materials like chamois soaks. Do not use acetone, toluene and alcohol cleaners because they cause chemical damage.
- Do not use liquid or aerosol cleaners.
- Wipe off saliva or water droplets as soon as possible. Long time contact with the screen causes deformations and color fading.

Screen care and sterilization

Avoid stationary images as much as possible. Stationary images are images that remain on-screen for extended periods of time. Examples include: on-screen menus, black bars and time displays. If you must use stationary images, reduce screen contrast and brightness to avoid screen damage.

Unplug the TV before cleaning.

Use a damp (not wet) cloth with only non-aggressive cleaners to wipe the TV. Use another damp (not wet) cloth to clean off the cleaning agent residue from the surface of the TV.

Recommended cleaning agents include:

- Bleach solution (10:90 concentration of bleach to water).
- Denatured alcohol (comprising of 80%-90% ethanol, 10%-20% methanol) Risk of damage to the TV screen! Never touch, push, rub or strike the screen with any object. To avoid deformations and color fading, wipe off water drops as soon as possible.

Environmental care

- Your product is designed and manufactured with high quality materials and components, which can be recycled and reused.
- The packaging of this product is intended to be recycled. Contact your local authorities for information about how to recycle the packaging. For product recycling information, please visit- www.recycle.philips.com



Please act according to your local rules and do not dispose of your old products with your normal household waste. Correct disposal of your old product helps to prevent potential negative consequences for the environment and human health.



- Like all LCD products, this set contains a lamp with mercury; please dispose of according to all local, state and federal laws. Philips pays a lot of attention to produce environment-friendly products in green focal areas. Your new TV contains materials which can be recycled and reused. At the end of its life, specialized companies can dismantle the discarded TV to concentrate the reusable materials and to minimize the amount of materials to be disposed of. Please ensure you dispose of your old TV according to local regulations. Disposal of used batteries The batteries supplied do not contain the heavy metals mercury and cadmium. Nevertheless, in many areas batteries may not be disposed of with your household waste. Please ensure you dispose of batteries according to local regulations.

Copyright



VESA, FDMI and the VESA Mounting Compliant logo are trademarks of the Video Electronics Standards Association.



Manufactured under licence from Dolby Laboratories. Dolby and the double-D symbol are trademarks of Dolby Laboratories.



Energy Star® qualified products and practices help you save money and reduce Greenhouse gas emissions by meeting strict energy efficiency guidelines set by the U.S. Environmental Protection Agency and U.S. Department of Energy.

2 Your TV

Standalone installation and side controls

This section describes how to install the TV channels automatically.

1. Connect the RF signal from the wall socket to the TV.
2. Plug the power cord into the power outlet.
 - 2-pin power cord (for D/L models)
 - 3-pin power cord (for H models)

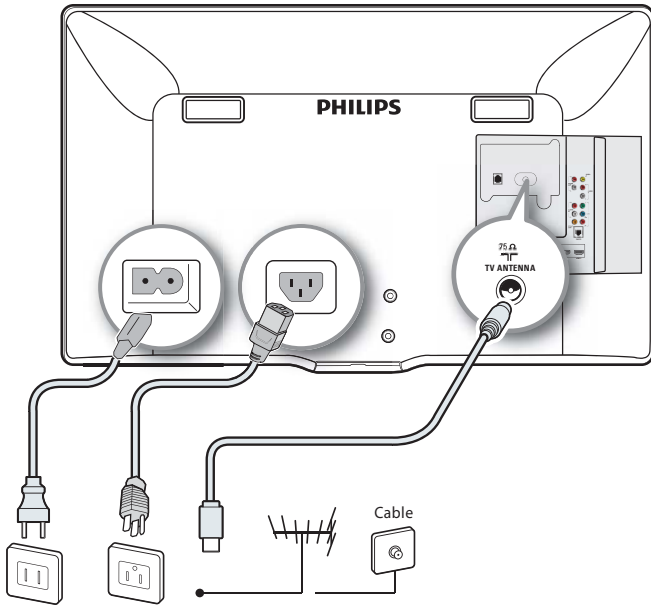

3. Turn the TV on.
 - Press **POWER** at the side of the TV.

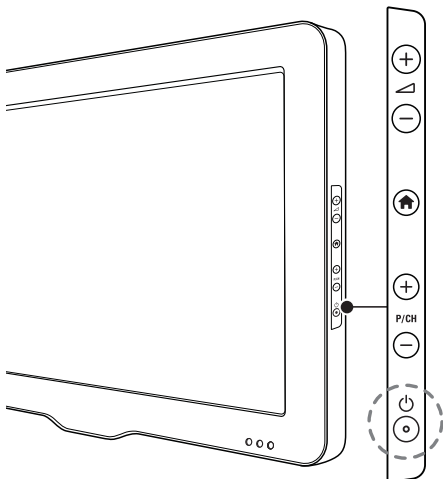

- Press **POWER** on the setup remote control.

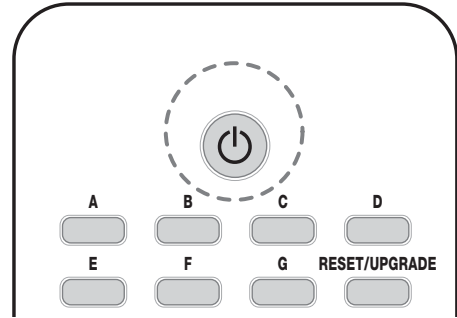

4. Press **RC5 SETUP** to display the setup menu.

Note

- The setup remote control is not included in the box. Contact your Philips authorized agent or dealer to acquire the setup remote control. Setup remote control might differ from the illustration.

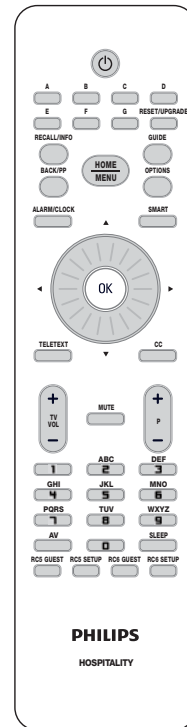

Guest remote control (optional)

- ① **POWER:** Press to turn on/off the TV from or to standby mode.
- ② **HOME:** Toggles the main menu on or off.
- ③ **SOURCE:** Selects connected devices.
- ④ **OPTIONS:** Selects different options.
- ⑤ **COLOR buttons:** Selects tasks or options.
- ⑥ **Forward button:** Fast forward feature.
- ⑦ **USB/MEDIA:** Access the USB files or photos.
- ⑧ **OK:** Confirm an entry or selection.
- ⑨ **Navigation buttons:** Navigates through the menus.
- ⑩ **SMART FEATURES:** Direct access to Smart Features.
- ⑪ **Mute:** Mute or restores audio output.
- ⑫ **Program +/-:** Switches to the next or previous channel.
- ⑬ **0-9 Numeric buttons:** Selects a channel or setting.
- ⑭ **FORMAT:** Launches the picture FORMAT menu.
- ⑮ **BACK:** Going back to the previous menu.
- ⑯ **Volume +/-:** Increases or decreases volume.
- ⑰ **SMART GUIDE:** Direct access to SMART GUIDE menu.
- ⑱ **CLOCK:** Unused button.
- ⑲ **Backward button:** Fast reverse feature.
- ⑳ **STOP:** Stop button.
- ㉑ **PLAY/PAUSE:** Select Play or Pause a picture.
- ㉒ **CC:** Enables Closed Caption.
- ㉓ **SLEEP:** Enable SleepTIMER feature.

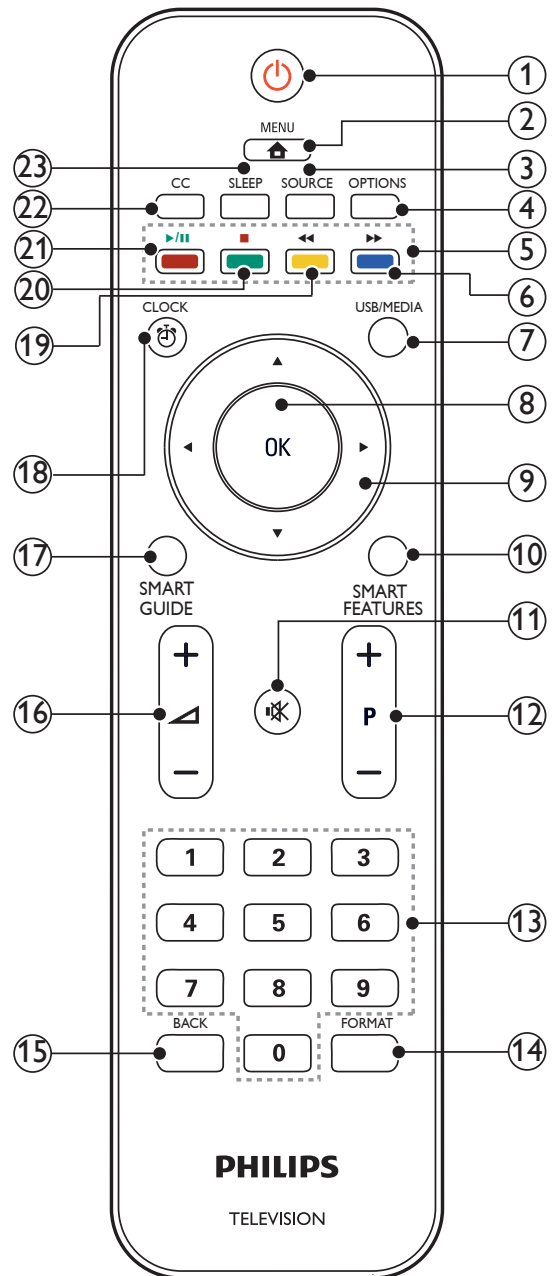

Philips Hospitality setup remote control (not included in box)

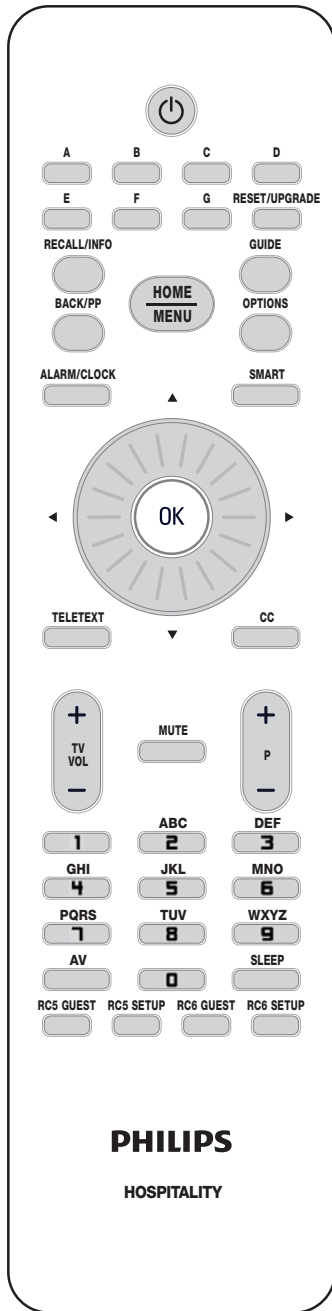

RC2573GR setup remote control (not included in box)

RC2573GR is an optional remote control. It is used for Philips Commercial Solutions features and SmartCard settings. It can be purchased separately.

- ① Slide this button up to enter into **Guest mode** or slide this button down to enter into **Setup mode**.
- ② **E button:** It has the same function as OK button.

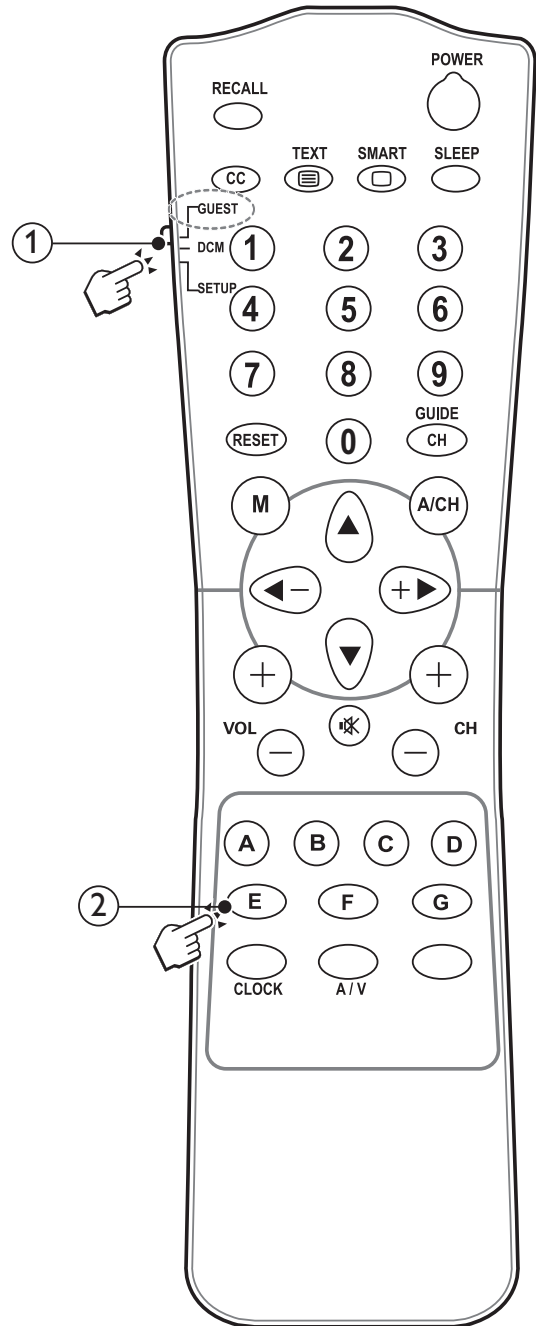



3 Installation

Smart Installation

In the 1st time (Virgin) installation, the OSD will instruct you step by step to do the TV installation setting.

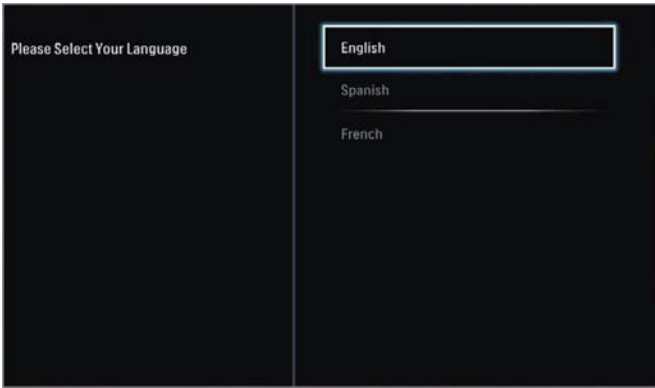
1. Please Select Your Language



- Choose a language and press  to select and proceed to the next step.



2. SmartInstall – Initial Wizard



- In the option, you can choose either “Skip” or “Continue” to continue the Smart Install.
- In the first time set up, choose “Continue” option and press  to enter the next step



3. SmartInstall – Connection to Paid-Per-View System

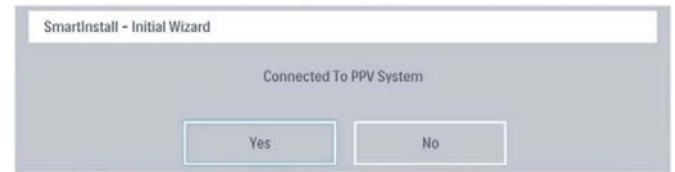

- In the option, you can choose “Yes” or “No” to Connected To PPV System.
- Choose either the “No” option and press  to enter the next step.
- Or for a PPV system installation, choose “Yes”. The Screen Menu will request for selection of Communication Type which includes SmartPort (select No, SPI-5V, SPI-3V3) and Serial Express.



4. SmartInstall – Standalone Pro:Idiom selection



- In the option, you can choose “Yes” or “No” to Using Standalone Pro:Idiom.
- In the first time set up, choose “No” option and press  to enter the next step.

After above setting is completed, you will enter the following setting OSD.

Install TV Channels

This TV is equipped with Helptext which will time out in 10 sec or upon Remote Control key press.

- **Install TV Channels:** This option allows you to Install TV channels. For the **“Install TV Channels”** option, you can do the setting for following options in sub-menu:



- Scan Type: “Cable” to receive TV signals from a cable, “Air” to receive TV signals from an antenna.
- Install TV Channels: “Auto”, “Manual”
- Confirmation page to “Start” the TV channels tuning.
- System Searching Status: “Digital Channels Found”, “Analog Channels Found”

Note

It is important to understand the difference between physical channel numbers and TV program numbers. When Auto Install is selected, the TV first scans for digital channels, starting at a physical (RF) channel 2 and then increasing in frequency to 3, 4, The first digital program it finds will be installed on TV program 1, the second on TV program 2 etc. Then the TV scans for analog channels. For the sake of discussion, let's assume that the TV found 36 digital programs. Then the first analog channel found would be installed as TV program 37, the second as TV program 38 etc. This could be a big change as most hybrid analog/digital systems have the analog programs on the lower physical channels and the digitals on the higher. But this is only the initial order that the Auto Install creates - the final order of the channel map that you wish to present to the guest is fully programmable.

- **Install TV Settings:** This option allows you to Install TV setting. For the **“Install TV Settings”** option, you can do the setting for following options in sub-menu:

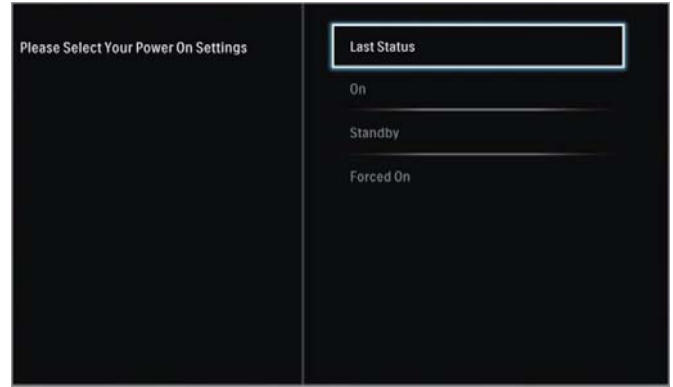

- Select Your Power On Setting: “Last Status”, “On”, “Standby”, “Forced On”
- When power to the TV is interrupted, this function sets the state that the TV will return to when power is restored.
- If set to Standby, the TV will always resume into Standby mode when power is restored (default setting).
- If set to Last Status, the TV will resume to the mode it was in when power was lost.
- If set to On, the TV will always turn-on into On mode when power is restored.
- If set to Forced On, the TV will turn-on to On mode, but it cannot be turned off. (For applications where TV is always on and you do not want anyone accidentally turning it off.)
- Default setting is Standby.



- Select Your Keyboard Lock Setting: “ No”, “Yes”, “All”.
- This function enables/disables the Keyboard buttons on the TV.
- If set to No, all keys are enabled. If set to Yes, all keys are locked except for the Power key. If set to All, then all keys are locked including the Power key.
- Default setting is “No”.

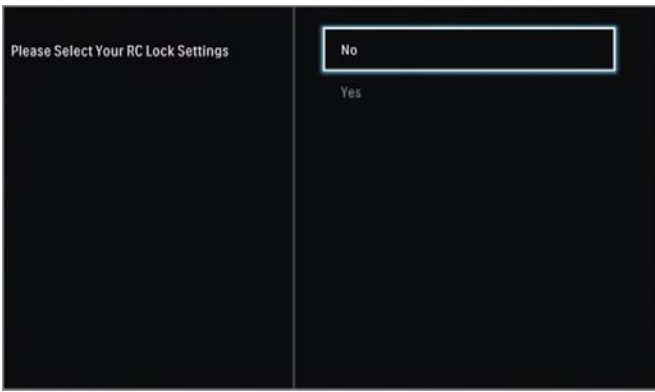

- Select Your RC Lock Settings: “No”, “Yes”.
- This function enables/disables the processing of the Guest remote control signals. Installer remote control signals will still function regardless of the setting.
- Default setting is “No”.



- Any CEC Communication: “Yes”, “No”
- This function enables/disables the HDMI-CEC functionality available on this TV.
- Default setting is “No”.



- Using Smart Secure: “Yes”, “No”.
- This function enables/disables the Smart Secure feature, which will check for a special security ID on a specific TV channel (when enabled). If the ID is found, the TV will function. If the ID is not found, the TV will display an error message and not function. This renders the TV non-functional if the TV is removed from the property.
- Default setting is “No”.



- Using Smart Update: “Yes”, “No”.
- This function enables/disables the Smart Update feature of the TV. If set to Yes, then SmartUpdate will automatically check for new TV upgrades at regular intervals and upgrade the TV software accordingly. You must select the channel # for the SmartUpdate data (default 87) and the time to check for updates (default 4:00 am).
- Default setting is Yes.



- Using Smart Guide: “Yes”, “No”.
- If you choose yes, then you have the further ability to enable/disable the available individual categories: High Definition; Sports; News; Kids; Movies; Network; Adult/Hospital*; Lifestyle; Other/Education*.
 - » Categories are Hospital and Education for Healthcare TVs (“H” models) or Adult and Other for Hospitality TVs (“D”, “L”, “F” models)
- Default setting is “No”.
- **Guest TV Settings:** This option allows you to set the Guest TV Settings”. For the **“Guest TV Settings”** option, you can do the setting for following options in sub-menu:



- Select Your Closed Caption (CC) Settings: “Off”, “On”, “CC on Mute”. CC on Mute is the default and recommended setting.

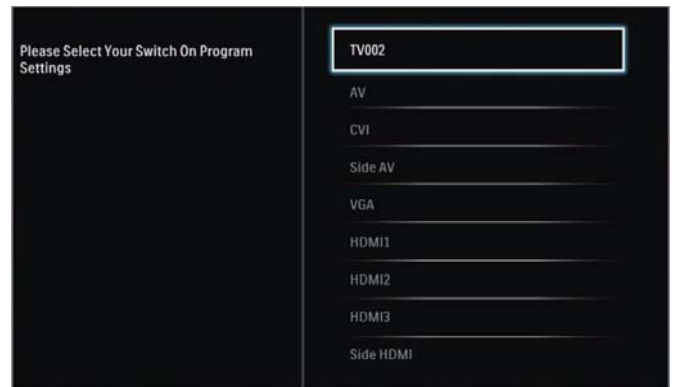

- Select your Switch On Program Settings: “TV”, “AV”, “CVI”, “Side AV”, “VGA”, “HDMI1”, “HDMI2”, “HDMI3”, “Side HDMI”.



- Set Your Minimum (0), Maximum (100), And Switch On (0-100) Volume.
- Default switch on volume = 12



- Any Welcome Message For Guest: "Yes", "No".



- Any Welcome Picture For Guest: "Yes", "No".



- Welcome Picture enables a customizable picture to be shown at TV startup to welcome the guest, before the TV switches to the channel or input source that is defined in Switch On Program.

Note

The welcome picture must be in the png format, and have the name WelcomeLogo.png and it must be on the USB drive in a folder named BUH_Logos. The size of the picture must be Width ≤ 940 pixels and Height ≤ 540 pixels. (Use of transparent background can create interesting images!)

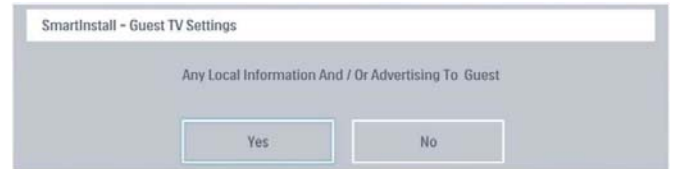

- Any Local Information And / Or Advertising To Guest: "Yes", "No".

Note

This TV has the capability to add a custom Hotel Logo icon to the Home guest menu screen (replaces the "PHILIPS" in the lower right corner). Then this icon can be assigned to a channel where the property runs informational or advertising programming. So when the guest clicks on this icon, the TV will switch to the assigned program. Similarly to the Welcome Logo, the Hotel Logo must be in the png format, and have the name HotelLogo.png and it must be on the USB drive in a folder named BUH_Logos. The size of the picture must be Width = 266 pixels and Height = 136 pixels. (Again, use of transparent background can create interesting images!) A smaller image can be used, but it should be centered in a canvas of the size specified.



- Any AV Source To Block: "Yes", "No".

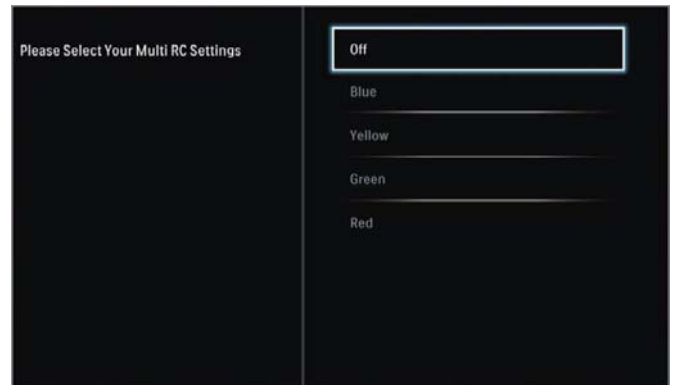

- Select Your Multi RC Settings: "Off", "Blue", "Yellow", "Green", "Red".
- Multi RC enables control of multiple TVs in a room without any interference from each other's remote control.
- To enable MultiRC, each TV and its associated remote control is set to one of the four colors – blue, yellow, green, red. Each TV in the room is separately programmed to a remote control of one of those colors.

Set the TV to a particular RC:

- » Use the set-up remote control and go to the PPV/ VOD options.
- » Press ▼▶ to go to the Multi RC option.

- » Press OK to select one of the four colors. The TV is configured to respond to the RC that is set to the same color:
 - » Press the color button (same color as above) on the guest RC simultaneously to set to the selected color:
 - » Press OK for five seconds while pointing to the TV. The TV displays the RC color and the TV color on the screen. If they do not match, program the TV and the RC again.
- In this way, each TV responds to only one RC that is set to the same color of the TV itself.

■ **Energy Saving Settings:** This option allows you to set the Energy Saving Features. For the **“Energy Saving Settings”** option, you can do the setting for following options in sub-menu:



- Select Your Smart Power Settings: “Off”, “Low”, “Medium”, “High”.
- This feature enables the customization of the power consumption of the TV. Set to High, savings in power consumption is typically around 50% as compared to when set to Off at maximum backlight setting.
- Default setting is “Off”.

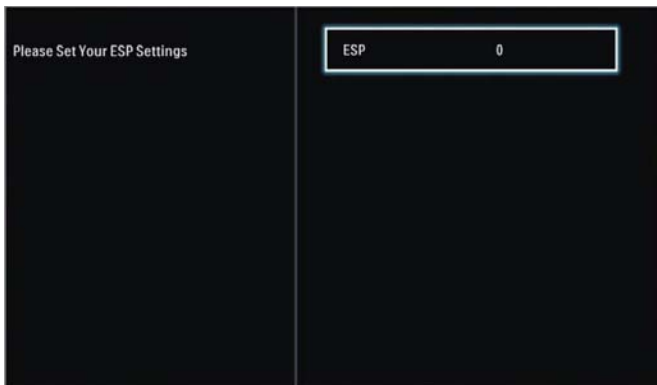

- Set Your ESP Settings.
- This feature enables the customization of the duration (in hours) in which TV will automatically turn off if there is no user interaction via remote control or keyboard. Setting this to 0 disables the function; this is the default setting.

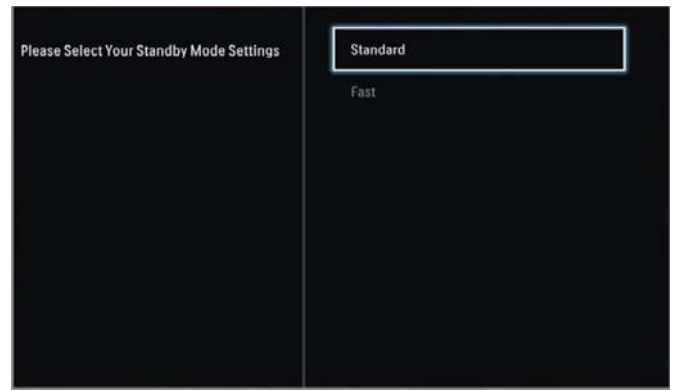

- Select Your Standby Mode Settings: “Standard”, “Fast”.
- This feature enables the customization of the TV standby behavior.
- Set to Standard, the TV will consume the least power during standby, but startup time will be longer and hospitality communication is not possible while the TV is in standby mode.
- Set to Fast, the TV will be best performing in terms of turn-on time and hospitality communication is also available while in Standby, but power consumption will be higher.

When above 4 settings are done, select “Done” and press  to confirm the “Smart Install Finished” is OK.

4 Home Screen

Press  key to go to the Home Screen.

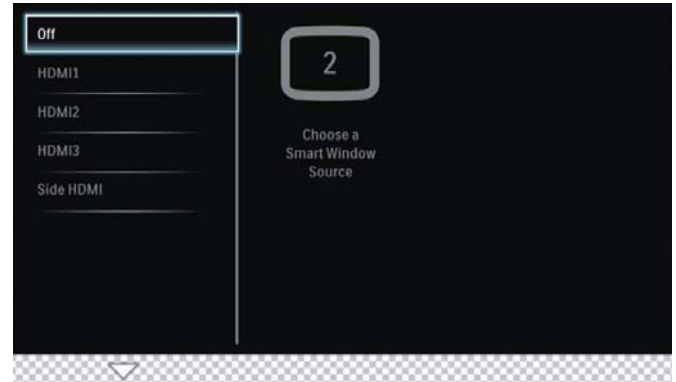

- Smart Window: "Off", "HDMI1", "HDMI2", "HDMI3", "Side HDMI".
- This feature enables the display of Smart Window from other sources other than the main programme being view currently. You can choose to display the HDMI display in the Smart Window and define the position of Smart Window.

Watch TV

In this option, you can use the cursor to select category you would like to see via OK key. This is the screen you see if SmartGuide is enabled, otherwise you see

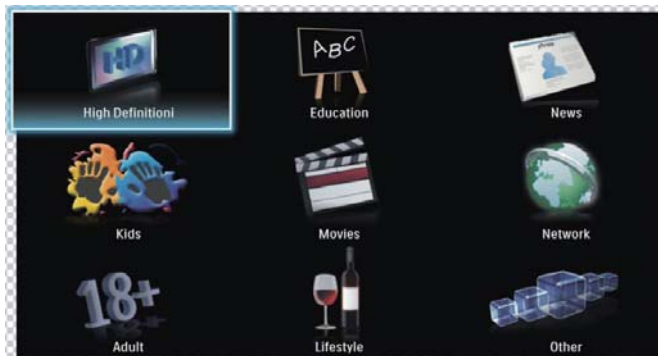

- "High Definition", "Sports", "News", "Kids", "Movies", "Network", "Adult/Hospital", "Lifestyle", "Other/ Education".

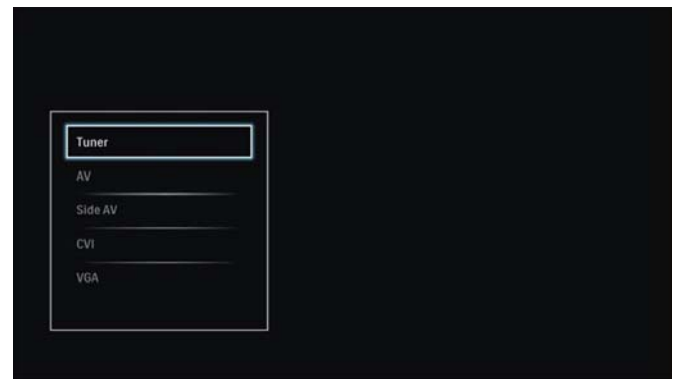

- Smart Audio: "Tuner", "AV", "CVI", "Side AV", "VGA".
- SmartAudioSelect enables the audio from different input sources connected to the TV to be selected while maintaining the current TV picture.

Smart Features

Select this option, you can start to set the "Smart Feature". For the "Smart Features" option, you can do the setting for following options in sub-menu:

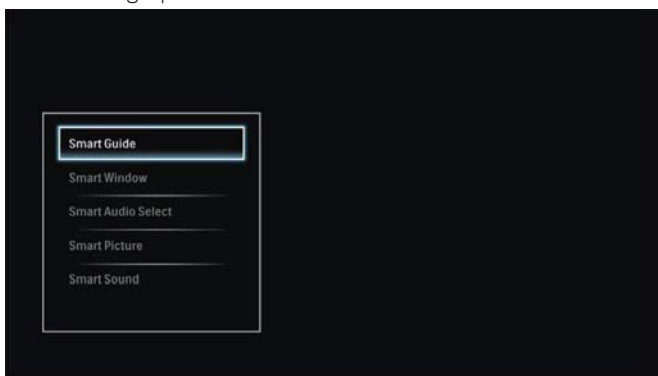

Enables list of Smart Features:

- Smart Guide
- Smart Window
- SmartAudioSelect (Split audio)
- Smart Picture
- Smart Sound

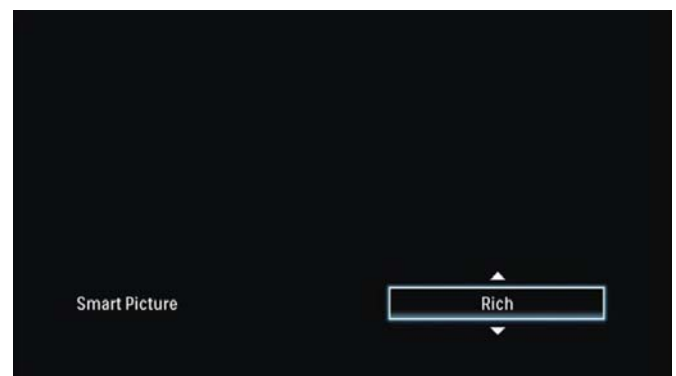

- Smart Picture: "Soft", "Natural", "Personal", "Rich".

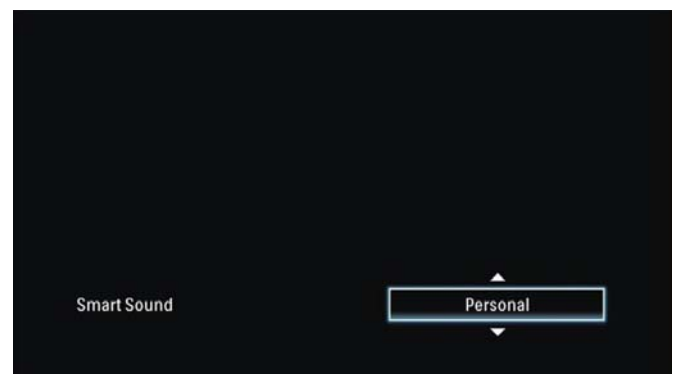

- Smart Sound: "Personal", "Music", "Voice", "Theatre".

USB

Using this option, you can select the files you want to play. For the **“USB”** option, you can do the setting for following options in sub-menu:

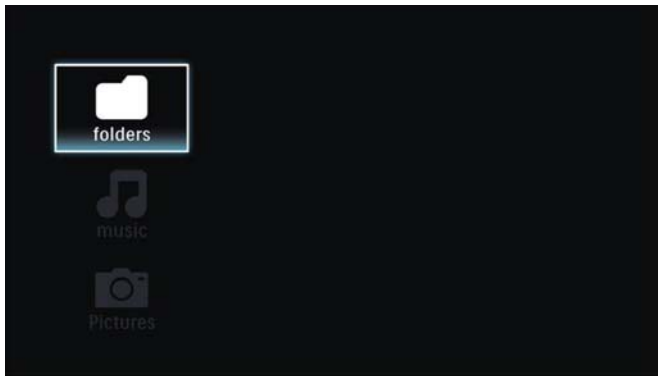

- “Folders”, “music”, “picture”

TV Settings in Guest Menu

In this menu, the following settings are available.

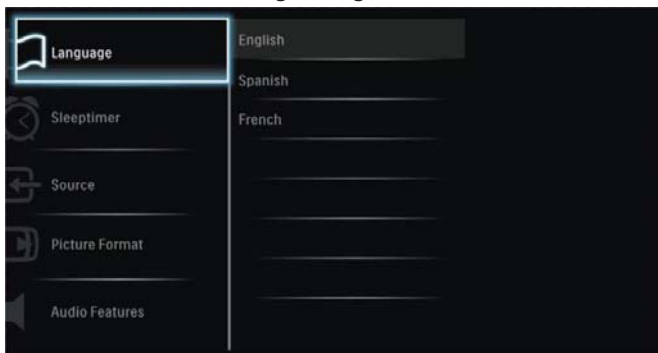

- Sets the Menu Language: “English”, “Spanish”, “French”



- Sleptimer: “OFF”, “15”, “30”, “45”, “60”, “90”, “120”, “180”, “240”. The TV will turn off after the selected time interval.



- Source: Select input as “Tuner”, “AV”, “Side AV”, “CVI”, “HDMI1”, “HDMI2”, “HDMI3”, “Side HDMI”, “VGA”



- Picture format: “Auto”, “MovieExpand 16:9”, “Superzoom”, “Widescreen”
 - This feature allows to set the TV display to the preferred picture format viewing mode.



- Audio: Enables “Audio Language” selection for digital channels, or enables “SAP” (Second Audio Programme) selection for analog channels.
 - “Smart Audio Select” enables the audio from different input sources connected to the TV to be selected while maintaining the current TV picture.



- CC Setup: "CC" — "Off", "On", "CC on Mute"
- This feature allows the Closed Captions settings of this TV to be customized. Any changes made in this section will be reset to default values when the TV is turned off.



- V-Chip Setup:
 - "US Movie Rating" – "G", "PG", "PG13", "R", "NC-17", "X", "NR"
 - "US TV Rating" – "Lock All", "Unlock All", "Done"

Note

G: General Programming
 PG: Parental Guidance
 PG-13: Parental Strongly Cautioned if Under 13
 R: Restricted. Accompanied By An Adult If under 17
 NC-17: No Children Under Age 17
 X: Adults Only
 NR: Not Rated



- "Analog CC Mode" – "CC1", "CC2", "CC3", "CC4", "TEXT1", "TEXT2", "TEXT3", "TEXT4"

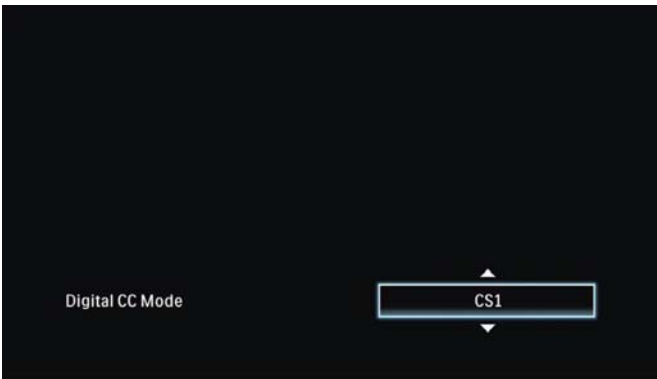

- "Digital CC Mode" – "CS1", "CS2", "CS3", "CS4", "CS5", "CS6"

5 Option

Press  key on the Guest Remote Control to enter the Option Menu Setting:

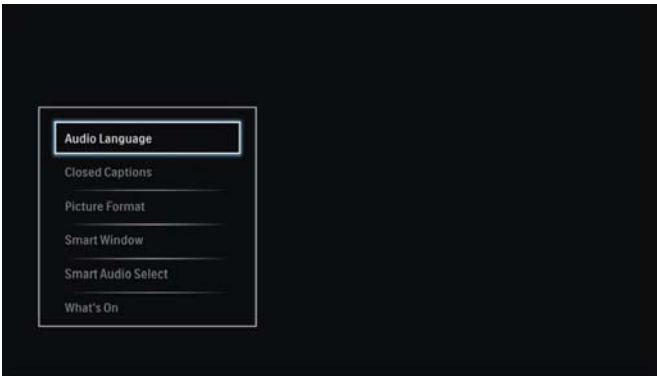

■ Audio Language:

- Displays options (if available) SAP allows you to select the Secondary Audio Program of the analog TV channel (if available)

or

- Audio Language allows you to select from the audio languages of the digital TV channel (if available)

■ Closed Captions:

- CC Setup:
 - » CC — “Off”, “On”, “CC on Mute”
 - » Analog CC Mode – “CC1”, “CC2”, “CC3”, “CC4”, “TEXT1”, “TEXT2”, “TEXT3”, “TEXT4”
 - » Digital CC Mode – “CS1”, “CS2”, “CS3”, “CS4”, “CS5”, “CS6”

For normal operation, choose Analog CC Mode = CC1 and Digital CC Mode = CS1

■ Picture format:

- “Auto”, “MovieExpand 16:9”, “Superzoom”, “Widescreen”

■ Smart Window:

- “Off”, “HDMI1”, “HDMI2”, “HDMI3”, Side HDMI”

■ Smart Audio Select:

- “Tuner”, “AV”, “Side AV”, “CVI”, “VGA”

■ What's On

- Indicate the current TV info

6 Hotel Setting

Press **M** on the Setup Remote Control to display the Hotel Setup Menu.

Hotel and Room Information

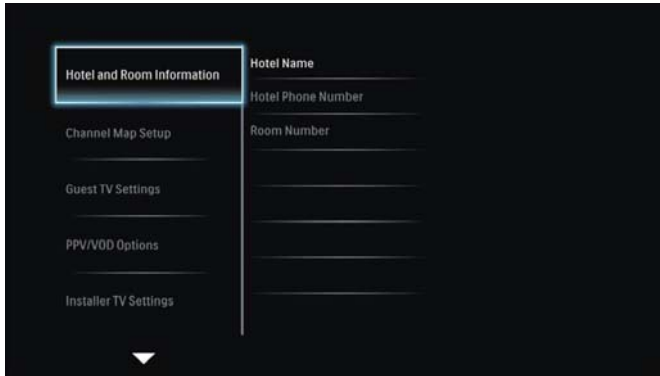

Select this option can set the hotel information to customer.

- **Hotel Name:** Use the virtual keyboard to enter the Hotel Name
- **Hotel Phone Number:** Use the virtual keyboard to enter the Hotel Phone Number
- **Room Number:** Use the virtual keyboard to enter the Room Number

Channel Map Setup

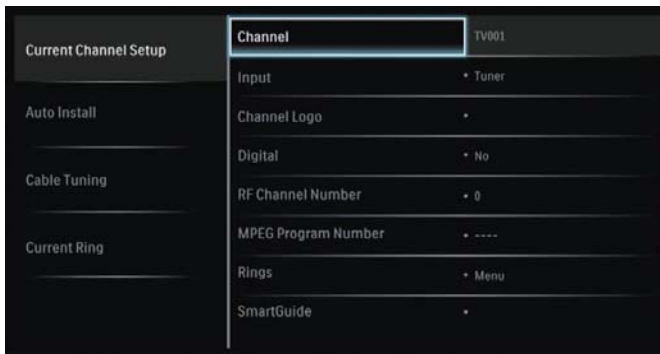

Current Channel Setup:

- **Channel:** Press 0-9 (Number buttons) to enter a program number.
 - For cable mode, select a number between 01-250.
 - For antenna mode, select a number between 02-250.
- **Input:** selection of input source. External input can also be assigned to a program number.
- **Channel Logo:** Press **▶** to enter a page containing logos, press **▲▼** to select a logo for the channel. Press **E** button on the set-up remote control to save the logo.
- **Digital:** Press Yes to select the digital channel.
- **RF Channel Number:** corresponds to Digital Major Channel:
 - Press 0-9 (Number buttons) to enter a channel number between 1 and 999.

- **MPEG Program Number:** corresponds to Digital Minor Channel.
 - Press 0-9 (Number buttons) to enter a channel number between 1 and 32768.
- **Rings:** This option define which Ring is to be currently used by the TV for Hotel guest viewing. The default is Ring 1, and only those channels marked as valid Ring1 channels are accessible on the TV.
- **SmartGuide:** This option allows selection of different category option (High Definition, Sports, News, etc).
- **Label:** This option assigns a (text) channel label to the current TV channel. The channel label will be displayed on the top of the screen during the changing of channels.
- **Mute:** Mute allows you to customize the video and/or audio muting of the current TV channel setup.
 - Set to Audio, the current TV channel will be audio muted.
 - Set to Video, the current TV channel will be video blanked.

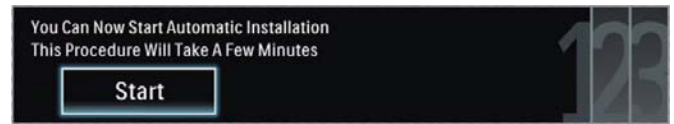

- Auto Install: "Start"

Note

It is important to understand the difference between physical channel numbers and TV program numbers. When Auto Install is selected, the TV first scans for digital channels, starting at a physical (RF) channel 2 and then increasing in frequency to 3, 4, The first digital program it finds will be installed on TV program 1, the second on TV program 2 etc. Then the TV scans for analog channels. For the sake of discussion, let's assume that the TV found 36 digital programs. Then the first analog channel found would be installed as TV program 37, the second as TV program 38 etc. This could be a big change as most hybrid analog/digital systems have the analog programs on the lower physical channels and the digitals on the higher. But this is only the initial order that the Auto Install creates - the final order of the channel map that you wish to present to the guest is fully programmable.

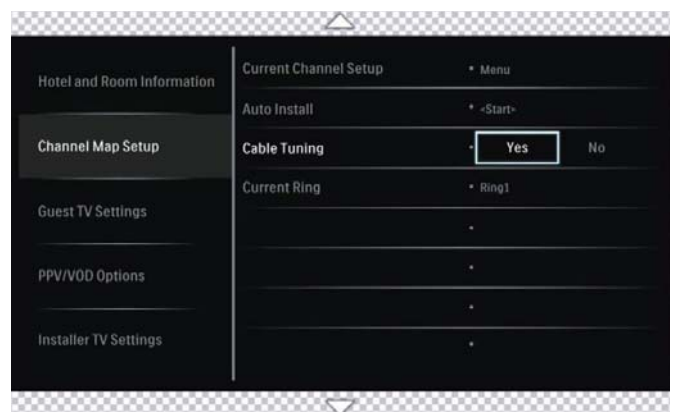

- Cable Tuning: "Yes", "No"

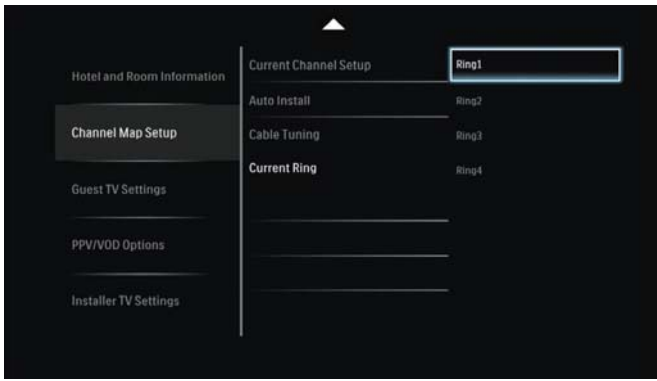

- Current Ring: “Ring1”, “Ring2”, “Ring3”, “Ring4”. Only those channels assigned to the “Current Ring” will be available to the guest.

Note

Channels can be assigned to more than one ring.

Guest TV Settings

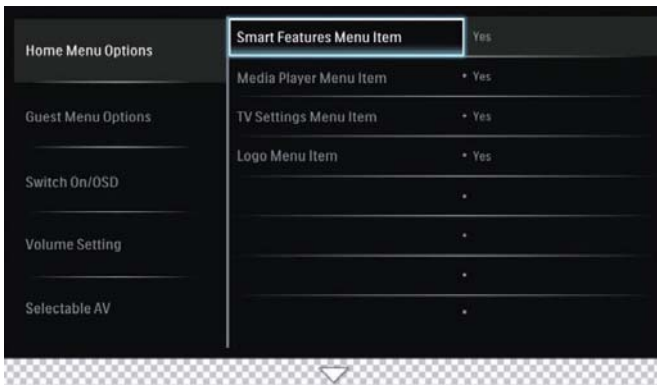

- Home Menu Options are : “Smart Features Menu Item”, “Media Player Menu Item”, “TV Settings Menu Item”, “Logo Menu Item”

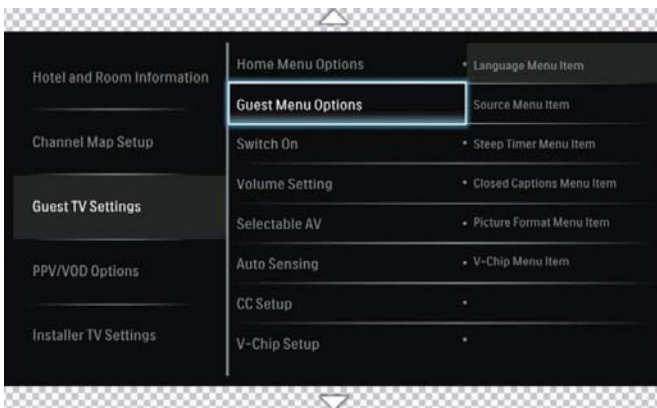

- Guest Menu Options are (selecting Yes/No for these items adds or removes their icons from the guest Home screen menu): “Language Menu Item”, “Source Menu Item”, “Sleep Timer Menu Item”, “Closed Captions Menu Item”, “Picture Format Menu Item”, “V-Chip Menu Item”

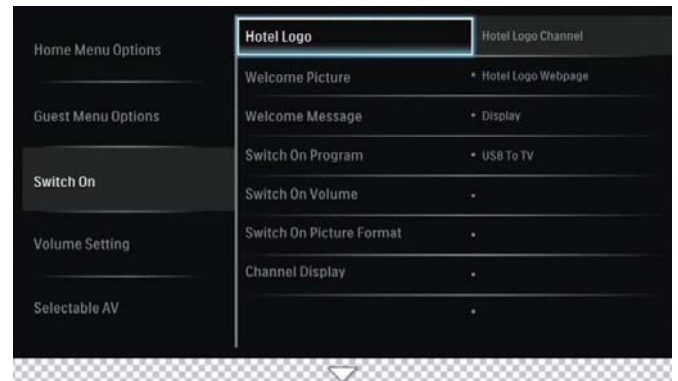

- Switch On Options are:
 - **Hotel Logo:** This option allows the TV to display a customized logo on the Home Menu of TV,
 - **Welcome Picture:** This option enables a customizable picture to be shown at TV startup to welcome the guest, before the TV switches to the channel or input source that is defined in Switch On Program.
 - **Welcome Message:** This option enables a customizable welcome text message (of 2 lines maximum, 20 characters per line) to be shown to the guest at TV startup.
 - **Switch On Program:** This option allows you to set a channel or input source which you want the TV to always tune to at TV startup.
 - **Switch On Volume:** This option allows you to set the volume setting to be heard by the guest at TV startup.
 - **Channel Display:** This option allows you to set the On Screen Display to include numbers only, labels only, numbers and labels, or none to be displayed.

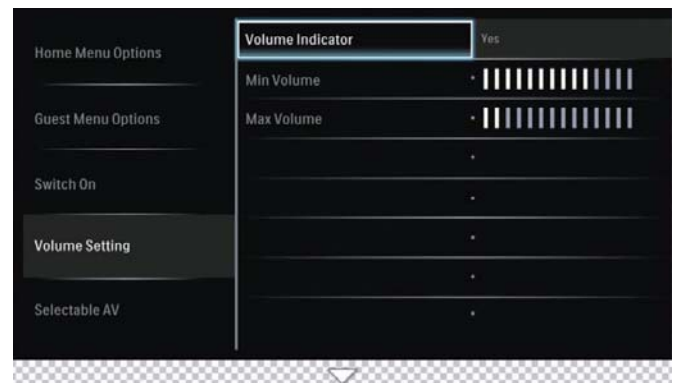

- Volume Setting:
 - **Volume Indicator:** This option enables/disables the display of the Volume Bar indicator when the Volume of the TV is adjusted.
 - **Min Volume:** This option sets the minimum volume level of the TV which the guest can adjust to. The minimum volume must always be less than or equal to the maximum volume.
 - **Max Volume:** This option sets the maximum volume level of the TV which the guest can adjust to. The maximum volume must always be greater than or equal to the minimum volume.



- Selectable AV (selecting Yes/No for these items adds or removes them from the list of available sources when the guest presses the Source button on the remote control.): “AV”, “CVI”, “Side AV”, “VGA”, “HDMI1”, “HDMI2”, “HDMI3”, “Side HDMI”



- Auto Sensing: “Side AV”, “VGA”, “Side HDMI”, “USB”
- This function allows you to enable/disable the auto sensing feature of the side input sources based on video or audio.
- Default setting is set to “Yes”.

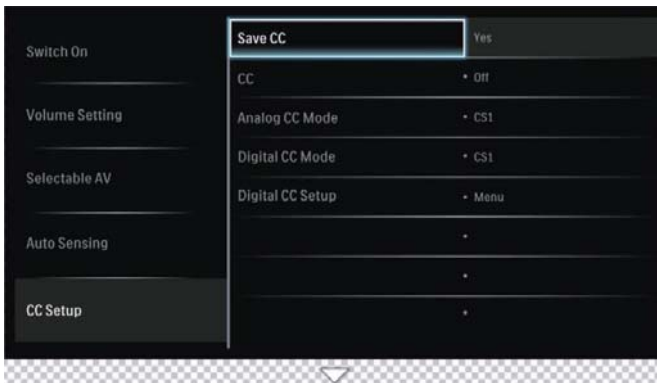

- CC Setup: “Save CC”, “CC”, “Analog CC Mode”, “Digital CC Mode”, “Digital CC Setup”
- Save CC allows you to set if the CC settings adjustment perform by guest shall be saved permanently or temporarily. If Yes, the CC settings adjustment done shall be saved permanently.
- CC sets the default Closed Caption selection in the Guest Menu, and the default CC mode at TV turn-on.



- V-Chip Setup: “Saved V-Chip”, “Clear All Rating”, “US Movie Rating”, “US TV Rating”
- Save V-Chip allows you to set if the V-Chip settings adjustment perform by guest shall be saved permanently or temporarily. If Yes, the V-Chip settings adjustment done shall be saved permanently.

PPV/VOD Options



- SmartPort: “SPI-3V3”, “SPI-5V”, “No”
- This function sets the voltage levels used for the SmartPort communication via the DATA1 connector of the TV. Selecting No disables the communications.

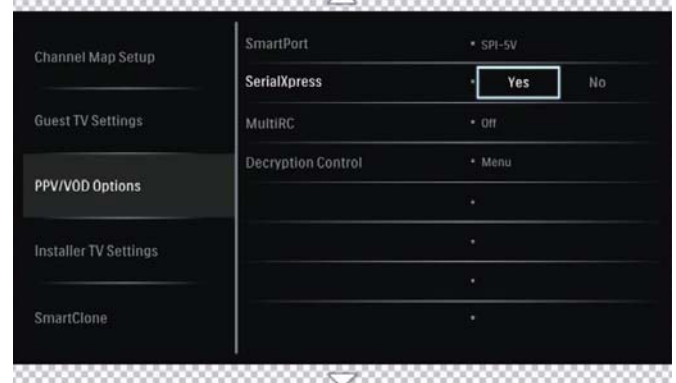

- SerialXpress: “Yes”, “No”
- This feature enables/disables the Serial Express communication via the RS232 connector of the TV.

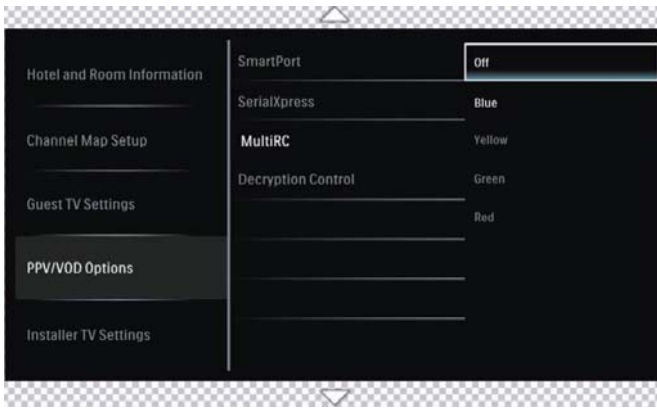

- MultiRC: “Off”, “Blue”, “Yellow”, “Green”, “Red”
- This function enables control of multiple TVs in a room without any interference from each other’s remote control.
- To enable Multi RC, each remote control is set to one of the four colors – blue, green, yellow or red. Each TV in the room is separately programmed to a remote control of one of those colors.
- In this way, each TV responds to only one RC that is set to the same color as the TV itself. This prevents interference from each other’s remote control when you watch multiple TVs in a room.

Note

Multi RC supports a maximum of four TVs in one room.

■ **Set the TV to a particular RC:**

1. Use the set-up remote control to enter the PPV/VOD and Multi RCoption menu,
2. Press ▼▲ to select the one of the four colors,
3. Press OK button on setup remote control to store the setting.

■ **Enable standalone mode (Decryption control)**

The premium HD content received by a satellite or cable is encrypted using a digital rights management system (DRM) called Pro Idiom® to avoid piracy. The technology is embedded in the TV and prevents guests from pirating the content.



- Decryption Control: “Model #”, “Serial #”, “Current Mode”, “New Mode”, “Password”, “Convert”, “Store”
- This function enables TV conversion between a Connected Pro:Idiom system and StandAlone Pro:Idiom system. The conversion mechanism is via a 9 digit keycode obtained from your Philips representative.
 - Enter the Philips Hospitality setup menu,
 - Enter the PPV/VOD options and go into the Decryption Control Menu,
 - Key in the TV model and serial number,
 - Set the current mode to Standalone via pressing of OK button,
 - Enter the 9 digit Passwod obtained,
 - Go to Convert option to decrypt the encrypted digital signal received from a satellite or Pay-Per-View service.

Installer TV Settings

This section allows the Installer to customize the TV performance and general settings.

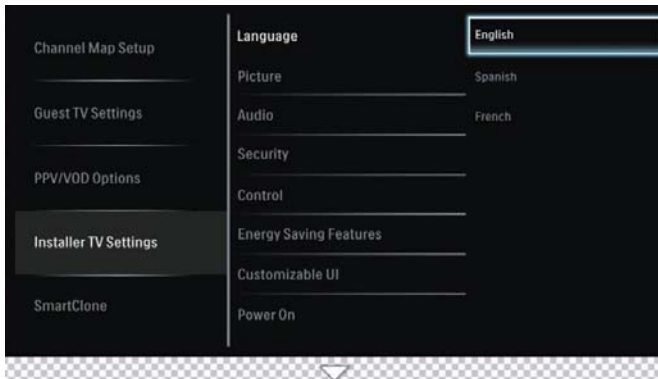

- Language: "English", "Spanish", "French"

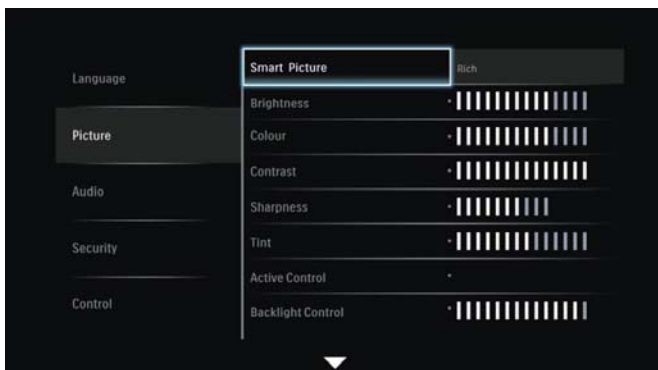

- Picture: This feature allows the installer to customize the Picture setting of the TV set. Options are "Smart Picture", "Brightness", "Colour", "Contrast", "Sharpness", "Tint", "Active Control", "Backlight control", "Colour Temp".



- Audio: This feature allows the installer to customize the audio settings of the TV set. Options are: "Smart Sound", "Equalizer", "Balance", "AVL", "Default HDMI1 Audio", "Default HDMI2 Audio", "Default HDMI3 Audio", "Loud Speaker Mute", "Bathroom Speaker Volume".

Note

- Default HDMI 1, 2, 3 Audio enables the customization of the default audio path of the HDMI1, 2, 3 input source. VGA can be selected if HDMI1, 2, 3 is dedicated for PC input where the audio input is via the PC audio in.
- Bathroom speaker volume allows you to configure the volume behavior of the bathroom speaker output. If set to Variable, the bathroom speaker volume will be identical to the TV loudspeaker volume. If set to Fixed, the bathroom speaker volume will be fixed at a constant level output..



- Security Options - This section allows the Installer to customize the Security settings of the TV. There are : "Security", "Keyboard Lock", "Remote Control Lock", "SmartSecure"
- Security - This function sets the Security access level of the TV Setup Menu. If set to High, access to the Setup menu is via the Installer Remote Control only. If set to Standard, access to the Setup Menu is via the Installer Remote Control, or via a keycode sequence on the normal Guest Remote Control.
- Keyboard Lock - This function enables/disables the Keyboard buttons on the TV. If set to No, all keys are enabled. If set to Yes, all keys are locked except for the Power key. If set to All, then all keys are locked including the Power key.
- Remote Control Lock - This function enables/disables the processing of the Guest remote control signals. Installer remote control signals will still function regardless of the setting.
- Smart Secure - This function enables/disables the SmartSecure feature, which will check for a special security ID on a specific TV channel (when enabled). If the ID is found, the TV will function. If the ID is not found, the TV will display an error message and not function. This functionality requires an external device (PSG) to be installed in the property head end. Contact you Philips sales associate if this functionality is required.



- Control: "Digit Timeout", "3-Digit Entry", "Step Tuning", "HDMI-CEC"
- This section allows the Installer to customize the Control and Performance settings of the TV.
- Digit Timeout - This function enables the setting of the timeout (in seconds) between digit key presses during TV channel changing. It is advisable not to specify too short a time period especially when you want to key in 2 or 3 digit channel numbers. Recommended and default setting is 3.0 seconds
- 3-Digit Entry - This function enables/disables 3-digit entries during TV channel changing.
- Step Tuning - This function enables/disables channel tuning at each digit key press. Set to Yes, each digit key press will perform a channel tuning instead of waiting for the entire 2 or 3 digits to be entered completely.
- HDMI-CEC - This function enables/disables the end user CEC functionality available on this TV.



- Energy Saving Features: "Smart Power", "Auto Sense", "ESP", "Standby Mode"
- Smart Power – This feature enables the customization of the power consumption of the TV. Set to High, savings in power consumption is typically around 50% as compared to when set to Off in maximum backlight setting.
- Auto Sense - This feature will enable/disable the Light sensor of the TV. If enabled, the ambient light conditions of the room will be measured to automatically configure the optimum power consumption and picture performance of the TV, according to the room ambience conditions.
- ESP - This feature enables the customization of the duration (in hours) after which TV will automatically turn off if there is no user interaction via remote control or keyboard. Set to 0 = disabled.

- Standby Mode - This feature enables the customization of the TV standby behavior. Set to Standard, the TV will consume the least power during standby, but startup time will be longer and hospitality communication is not possible. Set to Fast, the TV will be best performing in terms of turn-on time and hospitality communication is also available, but power consumption will be higher.

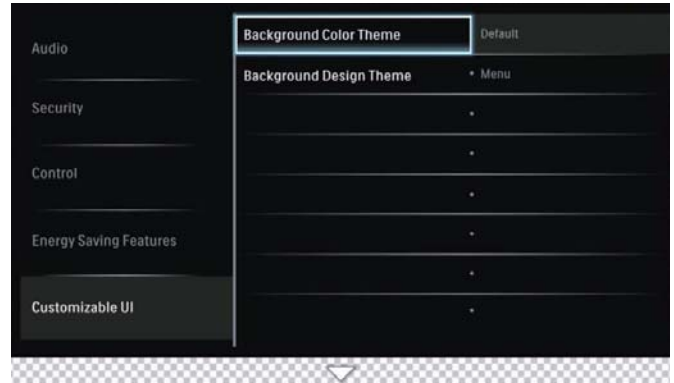

- Customizable UI feature: "Background Color Theme", "Background Design Theme"
 - This function enables the customization of the TV's Graphical User Interface via selection of colors and themes.
 - Background Color Theme - This feature enables the customization of the background color of the menus, to create a common brand recognition with the hotel property.
 - Background Design Theme - This feature enables customized background designs to be included and used as the background for User Interface menus. Like the Welcome Logo and the Hotel Logo, these also need to be in the png format. A transparency of < 65% is recommended. For the images and sizes see appendix A.



- Programmable UI feature : This feature is available to those with advanced Flash(R) Lite(R) programming capabilities.

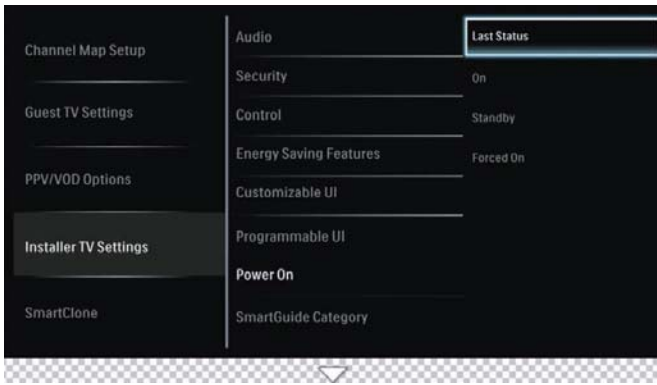

- Power On: “Last Status”, “On”, “Standby”, “Forced On”. Default setting is “Standby”. When power to the TV is interrupted, this function sets the state that the TV will return to when power is restored.
 - If set to Standby, the TV will always resume into Standby mode when power is restored (default setting).
 - If set to Last Status, the TV will resume to the mode it was in when power was lost.
 - If set to On, the TV will always turn-on into On mode when power is restored...
 - If set to Forced On, the TV will turn-on to On mode, but it cannot be turned off. (for applications where TV is always on and you do not want anyone accidentally turning it off.)



- SmartGuide Category: “SmartGuide”, “High Definition”, “Sports”, “News”, “Kids”, “Movies”, “Network”, “Adult/Hospital”, “Lifestyle”, “Other/Education”
 - If you choose yes, then you have the further ability to enable/disable the available individual categories: High Definition; Sports; News; Kids; Movies; Network; Adult/Hospital*; Lifestyle; Other/Education*
 - * Categories are Hospital and Education for Healthcare TVs (“H” models) or Adult and Other for Hospitality TVs (“D”, “L”, “F” models)
 - Default setting is “No”

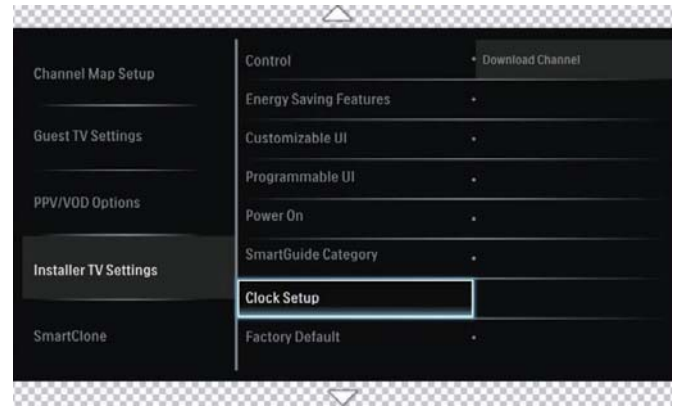

- Clock Setup
 - This feature allows the entering of TV channel number that will provide the date and clock information. This must be a digital channel containing an STT table (almost all digital channels do.)

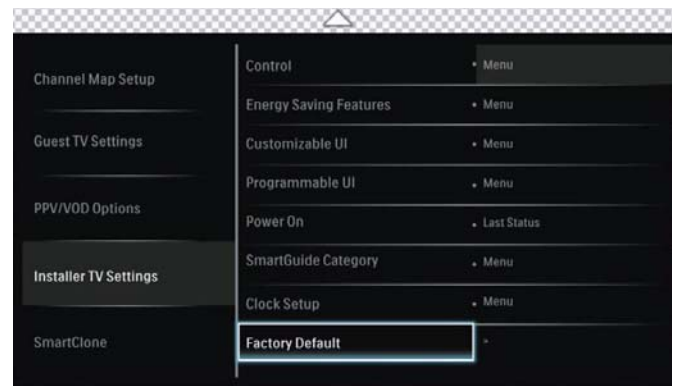

- Factory Default will reset the factory out-of-box settings.

Warning

- There is no confirmation request - if you press right arrow here, all programming is immediately and irrevocably reset to default values.

SmartClone

This section enables the cloning of TV settings via USB, RF.



- Source: “RF”, “USB” – This function selects the Source from which the Clone data will be received. To receive data over RF requires an additional piece of equipment (PSG) installed in the property head end to transmit the data to the TVs. Contact your Philips sales associate for more information.

TV Upgrade

This section enables the upgrading of the TV software via USB or RF. It also allows the configuration of the SmartUpdate feature to enable the TV to be automatically upgraded.



- Source: "RF", "USB" – This function Select the Source from which the TV Upgrade data will be received. Like the SmartClone function, the RF option requires a PSG installed in the property head end to broadcast the data to the TVs. For more information, contact your Philips sales representative.



- Direction: "USB To TV", "TV to USB"



- RF Channel Number

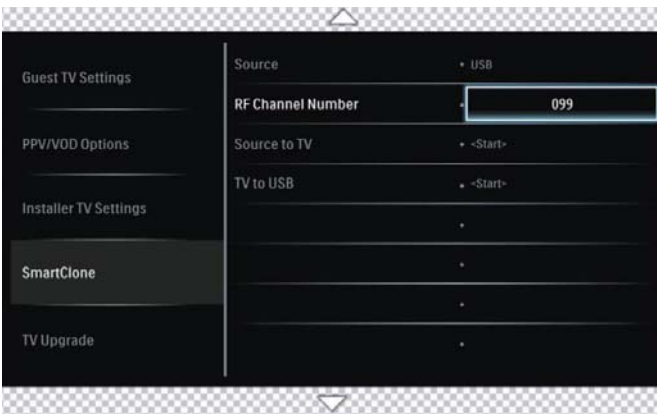

- RF Channel Number: This function selects the RF channel number where the TV can find the clone data. Note that both the PSG must be set to broadcast on the same channel that the TV must be set to receive.



- Source to TV: This function will initiate the cloning process of data from the selected source to the TV.



- TV to USB : This function will clone the data from the TV to a USB device.

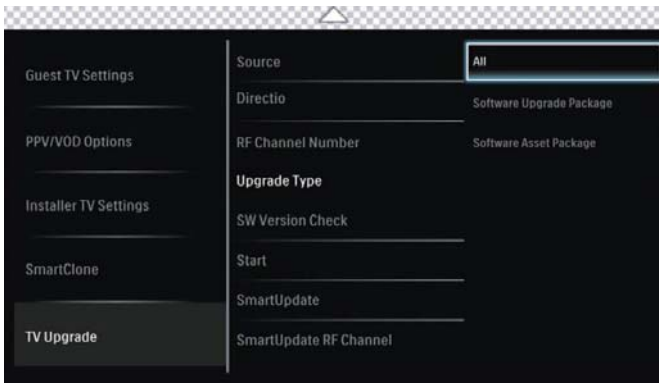

- Upgrade Type: "All", "Software Upgrade Package", "Software Asset Package"
- This section Select the type of software to be upgraded to the TV.
 - If set to ALL, then all software types (Software Upgrade Package and Software Asset Package) will be upgraded automatically.
 - If set to Software Upgrade Package, there is an option to selectively upgrade individual software components such as main software, standby software and back-end software.
 - If set to Software Asset Package, there is an option to selectively upgrade individual software assets such as Hotel Logo, Channel Logo, Welcome Logo, Customizable UI, Programmable UI and SmartModule Clone Data.



- SmartUpdate: "Yes", "No" - This function enables/disables the SmartUpdate feature of the TV. If set to Yes, then SmartUpdate will automatically check for new TV upgrades daily, at the time specified in the SmartUpdate Schedule step below, and upgrade the TV software and/or clone data if newer versions are found. Like all previous RF download functions, this too requires a PSG to be installed in the property head end.



- SW Version Check: "Yes", "No" - If set to Yes, this feature causes the TV to perform a version check of the TV upgrade software to ensure that only a newer version will be installed.

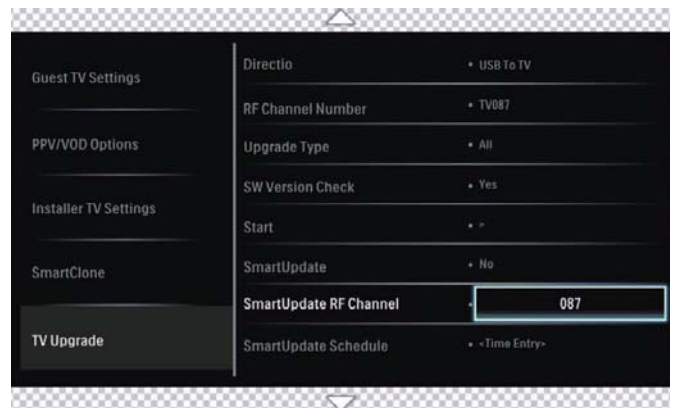

- SmartUpdate RF Channel: This function selects the RF channel number where the TV will search for SmartUpdate data (if SmartUpdate is enabled).



- SmartUpdate Schedule : This function allows Entering the time of the day when the TV will search for SmartUpdate data (if SmartUpdate is enabled).

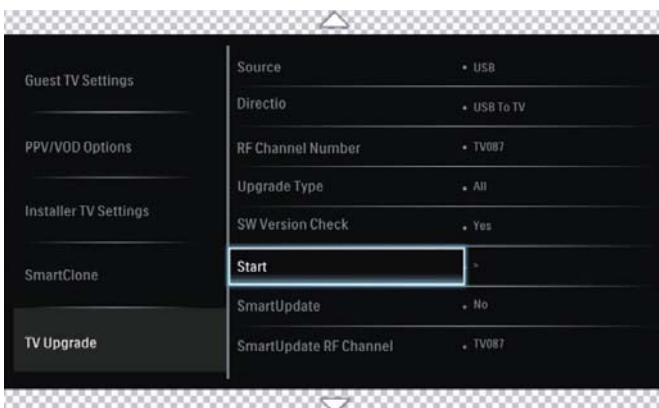

- Start - This function will initiate the TV upgrading process.

7 Overview of TV connectors and controls

L/D/H model

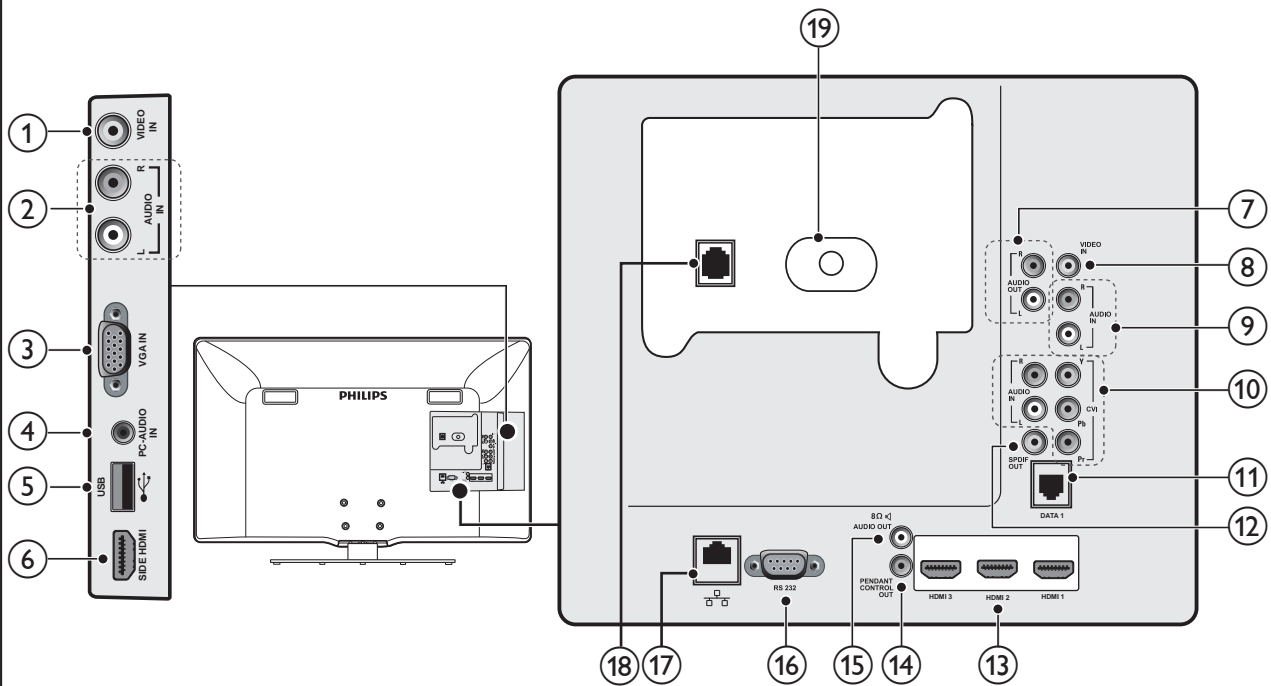

- ① VIDEO IN
- ② AUDIO IN L/R
- ③ VGA IN
- ④ PC-AUDIO IN
- ⑤ USB
- ⑥ SIDE HDMI
- ⑦ AUDIO OUT L/R
- ⑧ VIDEO IN
- ⑨ AUDIO IN L/R
- ⑩ CVI (YPbPr and AUDIO L/R)
- ⑪ Data 1
- ⑫ SPDIF OUT
- ⑬ HDMI 1 / HDMI 2 / HDMI 3
- ⑭ PENDANT CONTROL OUT
- ⑮ AUDIO OUT 8Ω
- ⑯ RS232 (Service Port)
- ⑰ Future Use
- ⑱ Game Port (Available on selected models only)
- ⑲ TV 75Ω

F models

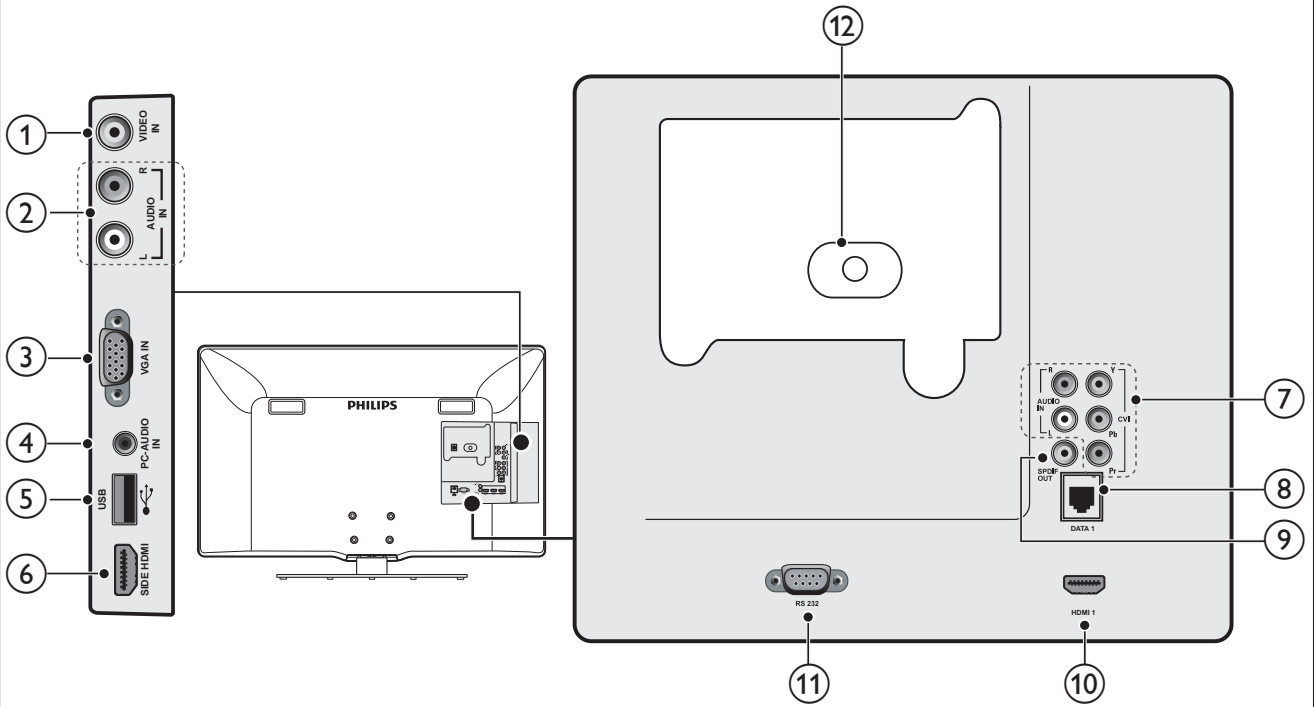

- ① VIDEO IN
- ② AUDIO IN L/R
- ③ VGA IN
- ④ PC-AUDIO IN
- ⑤ USB
- ⑥ SIDE HDMI
- ⑦ CVI (YPbPr and AUDIO L/R)
- ⑧ Data 1
- ⑨ SPDIF OUT
- ⑩ HDMI 1
- ⑪ RS232 (Service Port)
- ⑫ TV 75Ω

8 Glossary

Aspect Ratio	The ratio between the width and height of the TV picture on the screen. An old analog TV has an aspect ratio of 4 to 3 (4:3). The new aspect ratio for HDTV is 16:9 which is closer to the aspect ratio in a movie theatre (Widescreen). New TV systems support both 4:3 and 16:9 aspect ratio and can automatically switch between them.
Audio Video (AV)	A term often used when discussing a connections on a TV receiver or on video equipment, which has been especially designed to accept VCR or DVD audio-video signals.
CVBS	Composite Video Baseband Signal. In broadcast television this refers to the video signal, including the colour information and syncs. This is the yellow connector in an A/V input.
Component Video Input (Y Pb Pr)	Component Video Input is a type of connection that uses RCA-type connectors to allow set top boxes or analog DVD players to connect a signal to the TV. By offering the RCA-type input (YPbPr) analog High Definition signals can be connected from a set top box directly into the TV allowing for the signal to display on the screen.
HDTV	The generally agreed upon definition of HDTV is approximately twice the vertical and horizontal picture resolution of the old analog TV, which essentially makes the picture twice as sharp. HDTV also has a screen ratio of 16:9 as compared with the old TV screens, which have a screen ratio of 4:3. HDTV offers reduced motion artifacts (i.e. ghosting, dot crawl).
PPV	Pay Per View
Resolution	Resolution: A measurement of the finest (smallest) detail that is visible in a video image. TV Resolutions may be expressed as number of pixels in an image; or more commonly, As Total Number of (horizontally scanned) Lines used to create the image. Standard Digital TV Resolutions: SDTV: 480i –The picture is 720x480 pixels, 480p – The picture is the same 720x480 pixels, but non-interlaced. HDTV: 720p – The picture is 1280x720 pixels non-interlaced, 1080i – The picture is 1920x 1080 pixels interlaced. 1080p – The picture is 1920x 1080 pixels non-interlaced.
SPDIF	SPDIF (Sony and Philips Digital Interconnect Format) is the high quality digital audio output from the TV. Use this to connect the TV sound to a home theater audio system.

