

iTV



PHILIPS

Care of the screen

Do not touch the screen with anything hard as this may scratch, mar or damage the screen permanently. Do not rub with dust clothes with chemical treatment. Do not touch the surface with bare hands or greasy cloth (some cosmetics are detrimental to the screen). Unplug the TV before cleaning the screen. When the surface becomes dusty, please wipe gently with absorbent cotton or other soft materials like chamois soaks. Do not use acetone, toluene and alcohol because they cause chemical damage.

Do not use liquid cleaners or aerosol cleaners. Wipe off saliva or water drops as soon as possible. Their long time contact with the screen causes deformations and color fading.

Warning concerning stationary images on the TV screen (Plasma displays)

A characteristic of Plasma Display Panels is that displaying the same image for a long time can cause a permanent after-image to remain on the screen. This is called phosphor burn in. Normal use of the TV should involve the showing of pictures that contain constantly moving and changing images that fill the screen.

Warning concerning VGA/DVI display mode

As this product processes in VGA/DVI mode, some diagonal lines may be seen under circumstances of environmental interference. This will not affect the computer signal performance that displays in VGA/DVI mode.

Environmental

- Your television contains material that can be recycled and reused by specialized companies. Please find out about local regulations on the disposal of your old television set. Pay particular attention to the disposal of exhausted batteries used in your TV Remote Control unit.
- Your television consumes energy in the stand-by mode. Energy consumption contributes to air and water pollution. We advise you to switch off your television overnight instead of leaving it in stand-by mode.

Preparation

Wall mounting instructions/Table stand

According to the type of TV you've purchased a wall mount bracket and/or stand may be supplied. To mount the supplied stand and/or wall mount bracket, refer to separate instructions. Make sure that the wall mount is fixed securely so that it meets safety standards.

Make sure that air can circulate freely through the ventilation slots

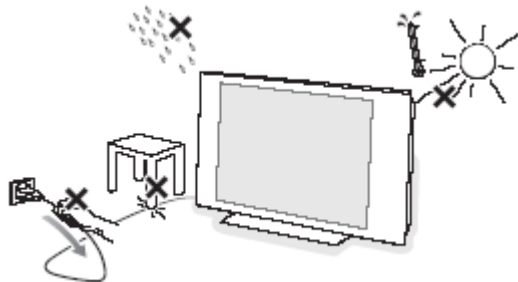

To prevent any unsafe situations, no naked flame sources, such as lighted candles, should be placed on or in the vicinity. Avoid heat, direct sunlight and exposure to rain or water. The equipment should not be exposed to any dripping or splashing moisture, and no objects filled with liquids, such as vases, should be placed on it. Insert the aerial plug firmly into the aerial socket at the bottom of the TV.

Connecting the Mains

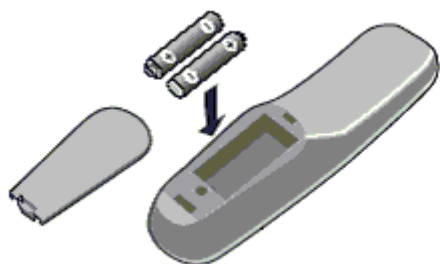

Insert the mains plug into the wall socket and switch on. Please refer to the label on the back of the television for the correct operating voltage.

Installing the remote control



- Remove the cover at the back of the remote control.
- Insert the correct type and size batteries into the battery compartment, making sure they are the right way around.

Switch the TV on:

Press the power switch  on the TV. An indicator on the front of the TV lights up and the screen comes on. If the TV is in standby mode (red indicator), press the - TV+ keys or the  key on the remote control.

To use the menus

Accessing the Set-up Menu

When the set is in the High Security Mode, the Setup menu can be accessed only with an Institutional Set-up Remote Control (RG4172BK or RC2573).



RG4172BK
(Optional)

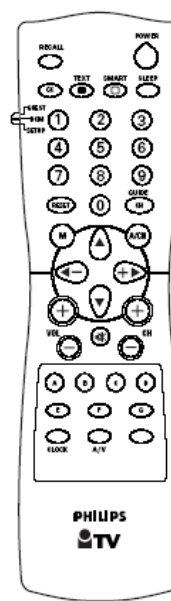

RC 2573
(Optional)

Navigation

The current menu item can be selected by means of the cursor up and cursor down keys. Submenus can be accessed from menu items with a “>” symbol by pressing the cursor right key.

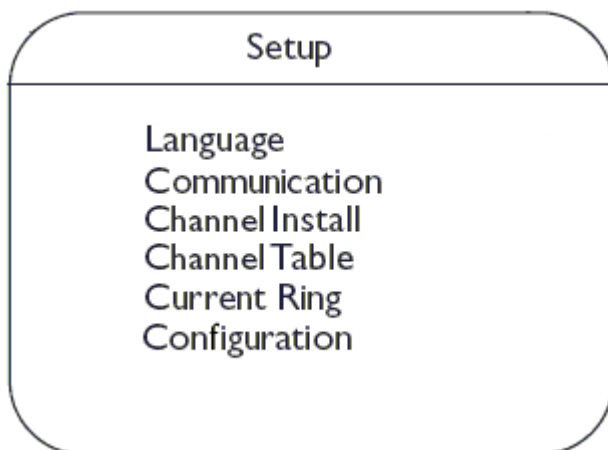

- To exit any menu press “Menu” button
- Select “YES” to activate/enable a setting, “NO” to deactivate/disable.

Setup menu items

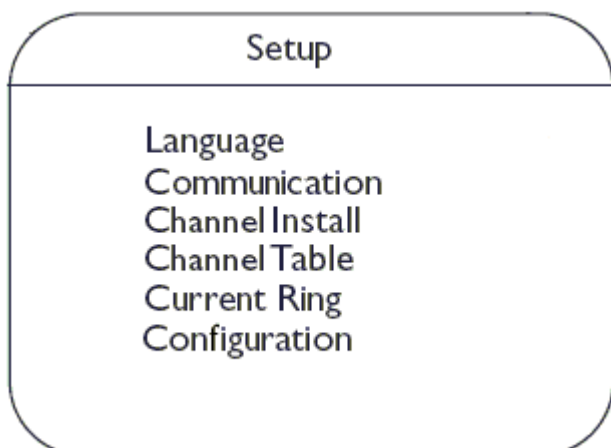

- **Language:** Select the language of the installation menu. Options are “ENGLISH”, “FRANCAIS”, and “ESPANOL”.
- **Communication:** The Communication menu is required to enable interactive applications and Healthcare Pendant controls. Refer to Annex C at the end of this document for more information.
- **Channel Install:** This sub menu allows setting the number of television channels.
- **Channel Table:** Allows selection between Cable and Antenna.
- **Current Ring:** This option allows selection of the Channel Ring (from 1 to 4)
- **Configuration:** In the Configuration menu, picture and control settings of the TV can be adjusted.

Channel Installation

In the Channel Install sub-menu, program settings can be set. When this menu is displayed, all the protections are inactive.

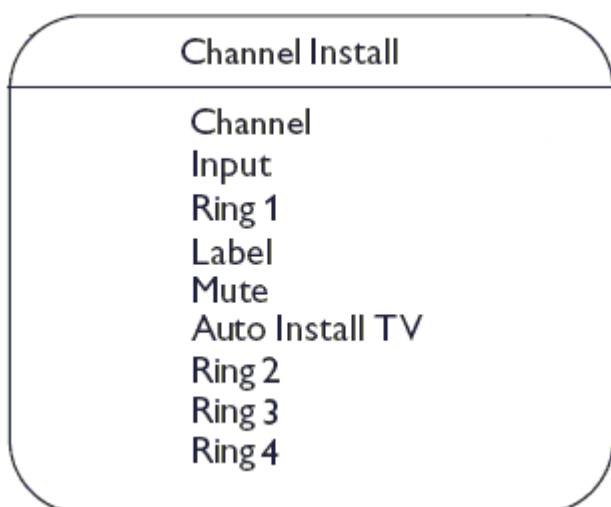

- **Channel:** The Channel number can be selected with the CH+/- buttons.
- **Input:** The "Input" menu item selects the desired input source that will be assigned to the channel. Possible values are TUNER, AV2, S-VIDEO, RADIO, VGA, CVI, HD-D, HD-A, and HDMI. Some input sources may not be available on certain sets.
- **Ring 1:** This menu item allows toggling between **Saved** and **Deleted** for Channel Ring 1
- **Label:** This menu item will be used to add a label/name for each channel.
 - By pressing the left/right buttons you may enter or exit the label field; by pressing the up/down cursor you may insert alphanumeric characters.
 - Pressing the Menu button lets you exit the “Label” menu item.

- **Mute:** This item enables/disables picture and sound for the particular channel.
 - NONE: normal picture and sound enabled
 - VIDEO: picture is blanked for this channel (e.g. radio channel)
 - AUDIO: sound is muted for this channel (e.g. information channel)
- **Auto Install TV:** This menu item initiates the automatic frequency searching of TV channels. Inside the “Auto Install TV” sub-menu, select **Start** to begin frequency searching. (**Note: In some LCD TV models, the TV screen may go completely blank for a short period of time, or there may be some brief flashing of images on the screen, while the TV is searching for channels to install. This is normal behaviour of the TV set. When all TV channels have been successfully stored, the first stored channel will then be displayed.*)
- **Ring 2/Ring3/Ring 4:** This menu item allows toggling between **Saved** and **Deleted** for Channel Rings 2/3/4.

Configuration

In the Configuration menu, various settings and features of the TV can be adjusted.

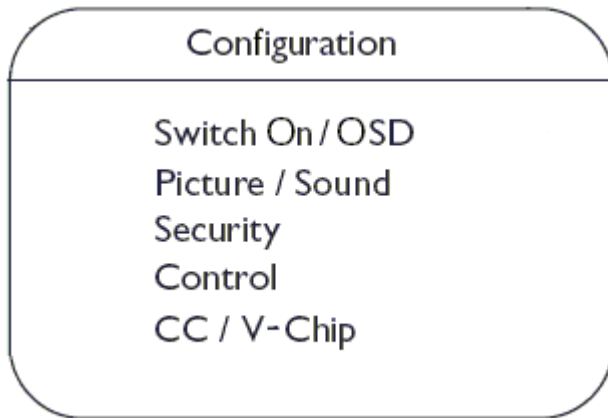

- **Switch On/OSD:** In this sub-menu the behavior of the TV after switching on and the behavior of the On Screen Display can be selected.
- **Picture/Sound:** In this sub-menu, the Picture and Sound settings of the TV can be selected.
- **Security:** In this sub-menu, the Security settings of the TV can be configured.
- **Control:** In this sub-menu, the Control settings of the TV can be configured.
- **CC/V-Chip:** In this sub-menu, the Close Caption and V-Chip settings of the TV can be configured.

Switch On / OSD

In this sub menu the behavior of the TV after switching on and the behavior of the On Screen Display can be selected.

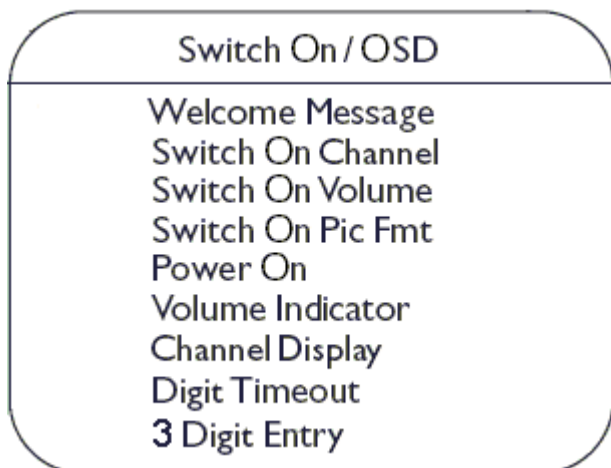

- **Welcome Message:** Press Cursor Left/Right to display the Welcome message entry menu:
 - **Welcome Message**
 - **Line 1**
 - **Line 2**
 - **Clear**With the Cursor Up/Down buttons you can set the message characters.
- **Switch On Channel:** This item sets the television's channel at switch on.
- **Switch On Volume:** This item sets the television's volume at switch on. Use the Right/Left Cursor buttons on the Remote Control to adjust.
- **Switch On Pic Fmt:** This item sets the television's Picture Format at switch on. Use the Right/Left Cursor buttons on the Remote Control to adjust.

- **Power On:** The Power On menu function defines the behavior of the television whenever AC Power is applied. The valid states are "FORCED ON", "LAST STATUS" and "STANDBY".
 - When "FORCED ON", the television can only be switched OFF by means of the main switch or a set-up remote control or by ESP function (Energy Saving Programmability controls the maximum continuous viewing time allowed by the control system).
 - When "LAST STATUS", the television switches on the previous status, ON or Stand-by.
 - When "STANDBY", the television always switches on in Stand-by.
- **Volume Indicator:** To display volume indicator when adjusting volume, select "YES". Select "NO" to hide the volume indicator.
- **Channel Display:** Program Display values can be: **Number, Label, All, None**.
- **Digit Timeout:** This is the time-out to enter the second digit of channel number (example: for channel number 10 and above).
- **3 Digit Entry:** To allow for 3-digit entry of channel numbers via the Remote Control, select "YES". Select "NO" to allow only 2-digit entry of channel numbers via Remote Control.

Picture and Sound settings

In this sub menu, the Picture and Sound settings of the TV can be configured.

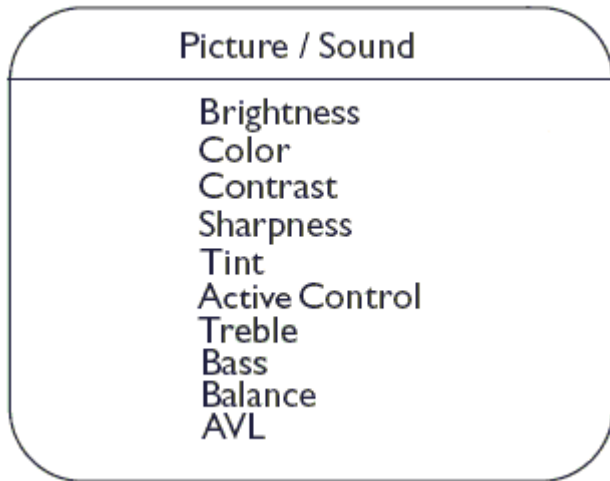

- **Brightness:** This changes picture brilliance.
- **Color:** This changes the intensity of the color.
- **Contrast:** This changes the difference between the light and dark tones.
- **Sharpness:** This changes the picture definition.
- **Tint:** Adjusts the picture to obtain natural skin tones.
- **Active Control:** Active Control optimises the quality of the picture according to the quality of reception.
- **Treble/Bass:** This adjusts the level of treble and bass effects on the TV's sound output.
- **Balance:** This balances the sound on the left and right speakers.
- **AVL (Automatic Volume Leveller):** This is used to limit increases in sound, especially on programme change or advertising slots.

Security settings

In this sub menu, the Security settings of the TV can be configured.

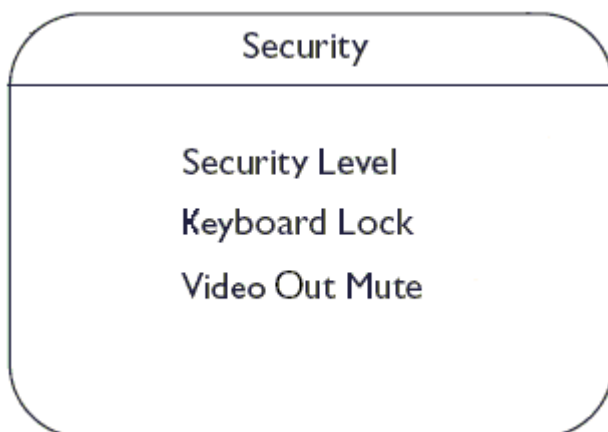

- **Security Level:** The menu function "SECURITY" allows the user to select one of two states "HIGH" or "STANDARD". The default is "STANDARD".
 - While the TV set is in the Security **High** Mode, the Set-up menu can only be accessed with an Institutional Set-up Remote Control.
 - While the set is in the Security **Standard** Mode, the Set-up Menu may be accessed either with an Institutional Set-up Remote Control, or with a guest remote control using an authorized access code.
- **Keyboard Lock:** The Keyboard Lockout menu function disables the television's local keyboard for volume and program control.
- **Video Out Mute:** This option allows the user to mute Video outputs from the TV set, to prevent unauthorized copying of Video content. (*Note: Available on certain models only).

Control settings

In this sub menu, the Control settings of the TV can be configured.

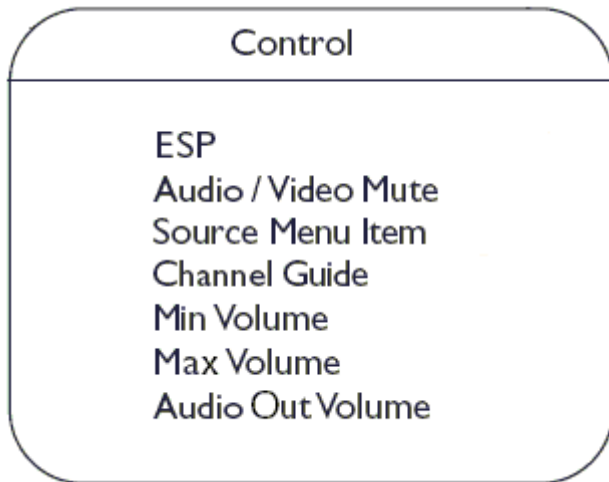

- **ESP:** Energy Saving Programmability Mode (ESP) controls the maximum continuous viewing time allowed by the control system. The ESP Menu function is shown as "ESP", and its valid values are 00 - 99 (in hours). 00 value means OFF.
- **Audio/Video Mute:** The Audio/Video Mute menu function determines whether the video should be blanked and the audio muted, if the currently tuned channel has no signal.
- **Source Menu Item:** Toggle between "YES/NO" to enable or disable selection of the TV Source Input via the guest Setup menu when using the guest Remote Control.

- **Channel Guide:** Select "YES" to allow the Channel Guide Menu to be displayed if the "Channel Guide" button is pressed on the guest Remote Control. Select "NO" to disable this feature.
- **Min Volume:** This item sets the limit for minimum volume allowed for the television set. Use the Right/Left cursor buttons to adjust.
- **Max Volume:** This item sets the limit for the maximum volume allowed for the television set. Use the Right/Left cursor buttons to adjust.
- **Audio Out Volume:** Set the volume of the external audio output (e.g. bathroom speaker). This volume is independent of the main speaker volume level. (**Note: Available on certain models only*).

Close Caption / V-Chip Setup

In this sub menu, the Close Caption and V-Chip settings of the TV can be configured.

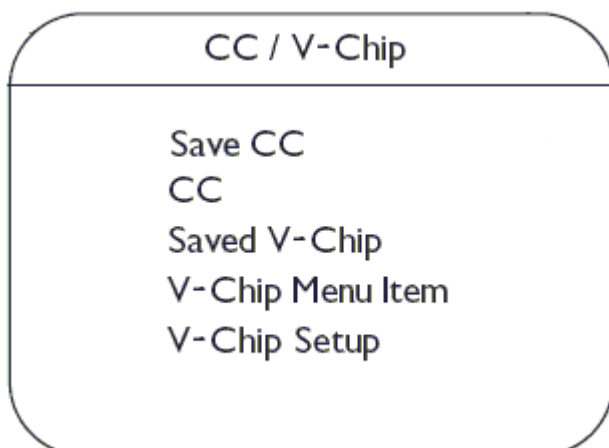

- **Save CC:** This menu item sets the option of saving the Close Caption selection to "Yes" or "No".
- **CC:** This menu item allows selection of Close Caption channels, or to turn Close Caption "OFF".
- **Saved V-Chip:** This menu item sets the option of saving the V-Chip selection to "Yes" or "No".
- **V-Chip Menu Item:** This menu item sets the option of toggling the V-Chip Menu Item to "Yes" or "No".
- **V-Chip Setup:** This sub-menu allows the setting and disabling of Movie and TV ratings for the V-Chip.

16:9 Formats

The pictures you receive may be transmitted in 16:9 format (wide screen) or 4:3 format (conventional screen). 16:9 pictures sometimes have a black band at the top and bottom of the screen (letterbox format). This function allows you to optimize the picture display on screen.

Using the different formats

Select the preferred format from the **Switch ON/OSD** Menu in the setup screen, or (if applicable) use the **16:9 Formats** button on the Remote Control to select the different modes: 4:3, Zoom 14:9, Zoom 16:9, Subtitle zoom, Super wide, Full screen, and Wide screen.

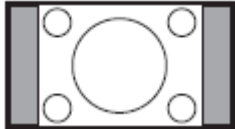

4:3

The picture is reproduced in 4:3 format and a black band is displayed on either side of the picture.

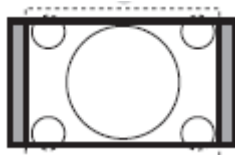

Zoom 14:9

The picture is enlarged to 14:9 format, a thin black band remains on both sides of the picture.

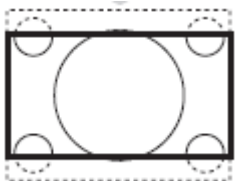

Zoom 16:9

The picture is enlarged to 16:9 format. This mode is recommended when displaying pictures that have black bands at the top and bottom (letterbox format).

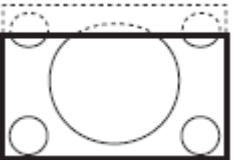

Subtitle Zoom

This mode is used to display 4:3 pictures using the full surface of the screen leaving the subtitles visible.

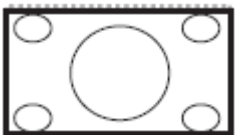

Super Wide

This mode is used to display 4:3 pictures using the full surface of the screen by enlarging the sides of the picture



Widescreen

This mode restores the correct proportions of pictures transmitted in 16:9 using the full screen display.

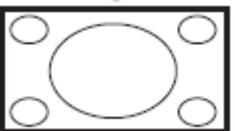

Fullscreen

This mode displays images in full screen.

Keys on the TV

Should your remote be lost or broken you can still change some of the basic settings with the keys on top of your TV.

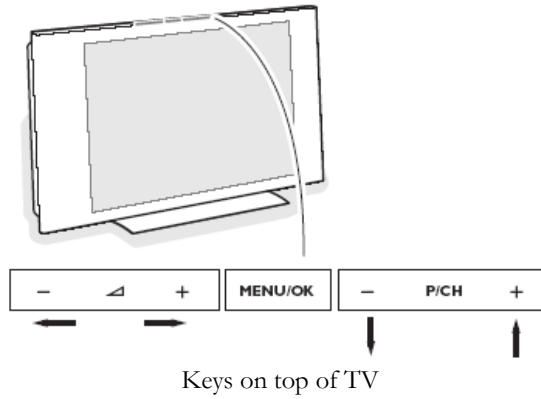

Press:

- The **- Vol +** key to adjust the volume;
- The **- P/CH+** key to select the TV channels or source

Press the **MENU/OK** key to summon the main menu without the remote control (*not available on all TVs*).

Use:

- The **- Vol +** key and the **- P/CH+** key to select menu items in the directions as shown;
- The **MENU/OK** key to remove the menu

Connecting the television set

This section provides information on the connectivity available for the LCD Television set.

20" LCD TVs

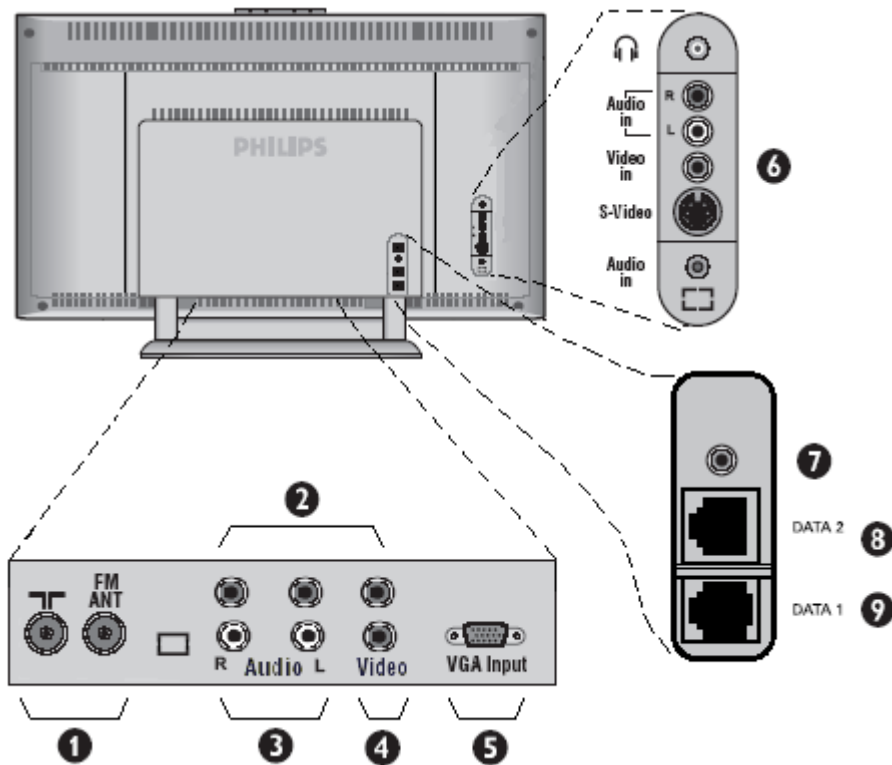

Connectors on the 20" LCD TV

1. TV and Radio aerial sockets
2. Component Video Inputs (CVI) connectors – Pr, Pb, Y
3. Audio-In connectors (AV1)
4. Video-In connector (AV1)
5. VGA connector for connecting HD devices (via HD-A mode, with appropriate cables)
6. Side IO Connectors (AV2) – Headphones, Audio-In, Video-In, S-Video, and HD-Audio In
7. Pendant Control jack
8. Data 2 (RJ45) jack – for interactive connectivity purposes
9. Data 1 (RJ12) jack – for interactive connectivity purposes

Mounting the Television Stand

This section provides information on mounting the stand for the LCD Television set.

20" LCD TVs

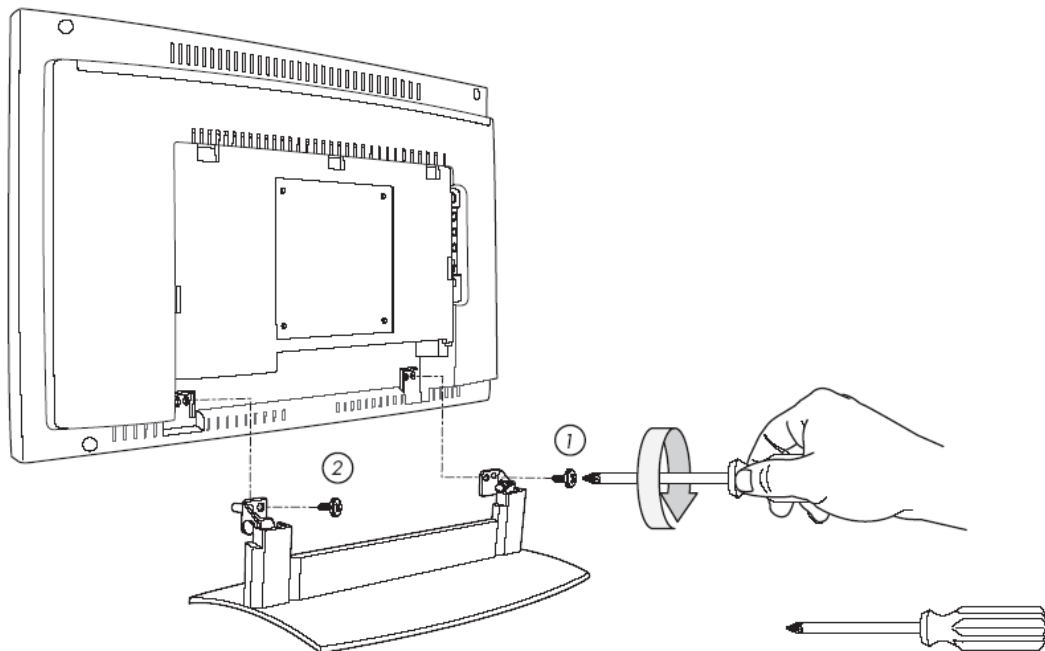
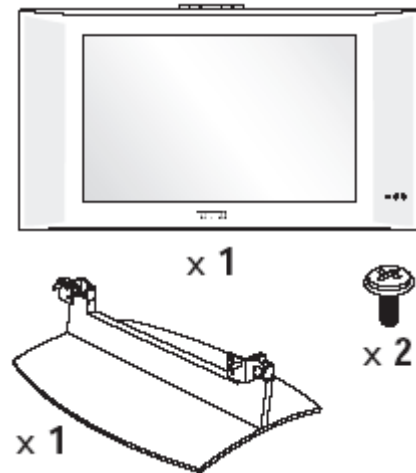
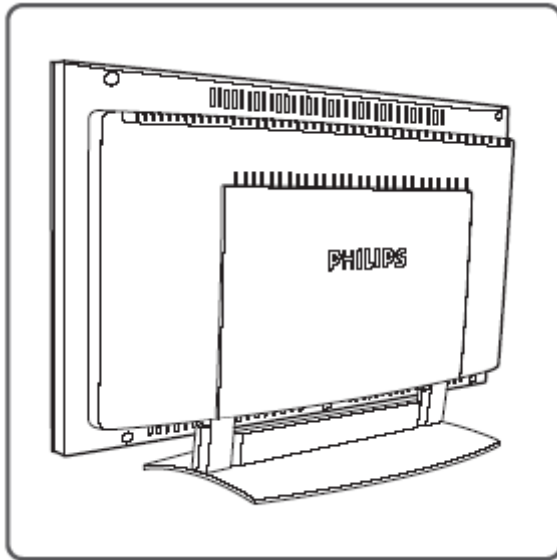

Annex A Health Care Pendant / Pillow Speaker Operation

The Philips 20FT3310 Institutional Television product can be used in hospitals and other medical facilities. It is compatible with a type of device known as a “pillow speaker” or “pendant control”. This device contains a built-in speaker for bedside audio, while also providing television power, channel, and volume control functions, all by means of a three-conductor cable. Examples of two such devices are described herein. The following products are manufactured by Curbell Industries (www.curbell.com), Orchard Park, NY.



“Analog” style pillow-speaker control

The “analog” version of the pillow speaker, as it is sometimes referred to, provides a built-in speaker, a volume control, and one dual-purpose button that both selects the TV channel, and powers the television on and off.

If the television is in the standby state (power off), a single press of the channel / power button will turn the unit on.

When the television is on, each press of the button increments the currently-tuned channel.

If the television is on, it will power off when the the channel / power button remains depressed for four successive channel increments (the television will power off *after* the fourth channel increment).

NOTE: Analog-style controls tend to exhibit a relatively slow response time to channel commands. This is normal, and is not indicative of a system problem.



“Digital” style pillow speaker control

One example of a so-called “digital” version of the pillow speaker provides a built-in speaker, a volume control, and dedicated buttons that perform the following functions, as indicated.

- Power on/off
- Channel up
- Channel down
- Closed-caption
- Channel guide

Annex B Connection Information for Healthcare Pendant

The following diagram illustrates the connection of the Healthcare Pendant Control to the Philips LCD TV.

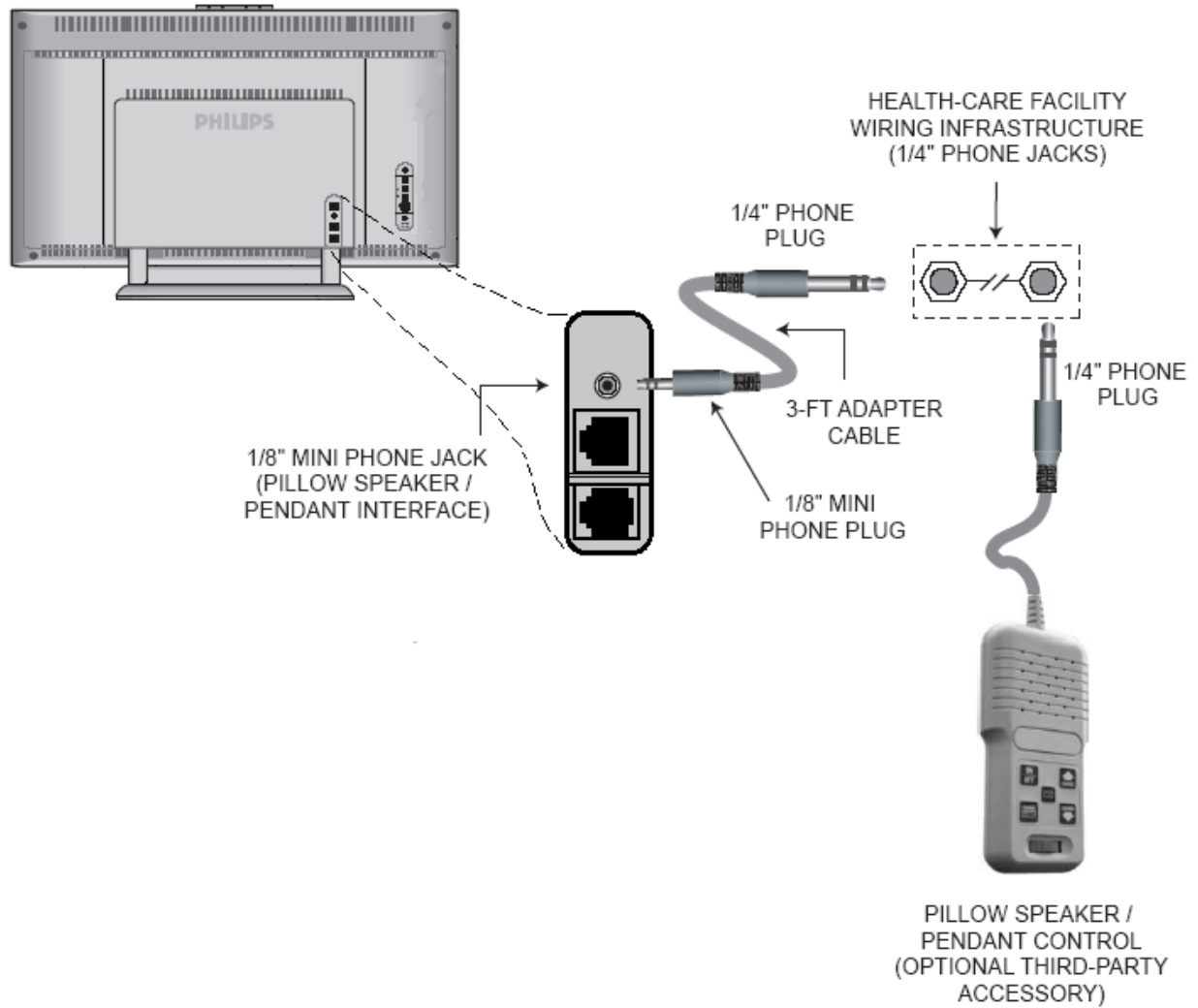

Annex C Communication Menu of the LCD TV

The Communication Menu allows the selection of different communications protocols between the LCD TV and external interactive devices that may be connected to the TV. By default, the Communication setting should be set to “OFF”. In order to select the appropriate Communication setting, refer to the application notes or installation documentation that is provided with the external interactive devices.

The Communication Menu also allows a Pendant Control to be enabled. Select “Yes” next to the item “Pendant” to enable the Pendant Control, and then select “Store” to ensure that this setting is saved. Make sure the pendant control device has been properly attached to the LCD TV first before enabling it via this menu.

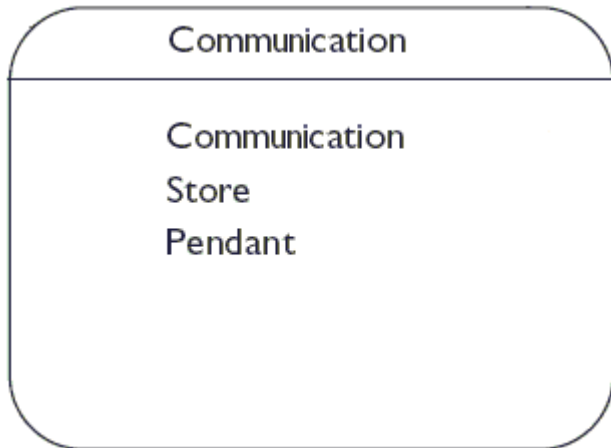

- **Communication:** Toggles between different communications protocols for use with (external) interactive devices. The default setting is “OFF”
- **Store:** Use the Right/Left Cursor buttons on the Remote Control to select this option. This will store all the settings that have been modified in the Communication menu only.
- **Pendant:** Toggle between “YES/NO” to enable or disable selection of the Healthcare Pendant Control.

