

Register your product and get support at

[www.philips.com/welcome](http://www.philips.com/welcome)



55PFL76x6H  
47PFL76x6H  
42PFL76x6H  
37PFL76x6H  
32PFL76x6H  
55PFL76x6K  
47PFL76x6K  
42PFL76x6K  
37PFL76x6K  
32PFL76x6K  
55PFL76x6T  
47PFL76x6T  
42PFL76x6T  
37PFL76x6T  
32PFL76x6T

---

EN User Manual

**PHILIPS**

# Contents

<b>1</b>	<b>Get started</b>	<b>3</b>	<b>6</b>	<b>Troubleshooting</b>	<b>56</b>
	TV tour	3		Contact Philips	56
	Important	6		General TV	56
	Environmental efforts	8		TV channel	56
	Position the TV	9		Picture	56
	Help and support	10		Sound	57
<b>2</b>	<b>Use your TV</b>	<b>11</b>		HDMI	58
	Controls	11		USB	58
	Watch TV	13		Network	58
	Watch a connected device	16	<b>7</b>	<b>Product specifications</b>	<b>59</b>
	Watch 3D	17		Power and reception	59
	Ambilight	18		Display and sound	59
	Browse PC through DLNA	20		Display resolutions	59
	Browse Net TV	21		Multimedia	60
	Rent online video	23		Connectivity	60
<b>3</b>	<b>Use more of your TV</b>	<b>25</b>		Dimensions	62
	Enjoy HbbTV	25		Help version	63
	Smart USB recording	25	<b>8</b>	<b>Index</b>	<b>64</b>
	View Teletext	28			
	Set locks and timers	29			
	View subtitles	30			
	View Scenea	31			
	Set universal access	31			
	Use EasyLink	32			
<b>4</b>	<b>Set up your TV</b>	<b>36</b>			
	Settings assistant	36			
	Picture and sound	36			
	Channels	37			
	Menu language	40			
	Other settings	40			
	Update software	41			
	Reinstall the TV	42			
<b>5</b>	<b>Connect your TV</b>	<b>43</b>			
	About cables	43			
	Connect devices	44			
	Connect more devices	50			
	Computers and the Internet	52			
	Common interface	55			

# 1 Get started

## TV tour

### Remote control

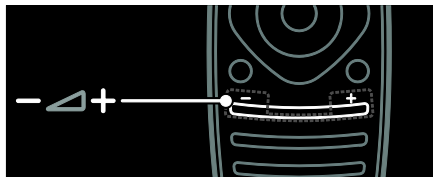

To adjust the volume.

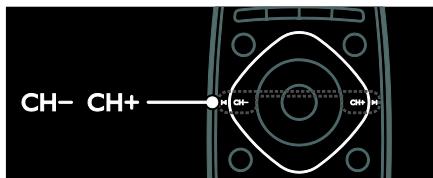

To switch TV channels.



To open or close the **Home** menu.

In the Home menu, access connected devices, picture and sound settings, and other useful features.



To open or close the **Source** menu.

In the Source menu, access connected devices.



To open or close the **Find** menu.

In the Find menu, access the channel list.



To open or close the **Adjust** menu.

In the Adjust menu, access a range of frequently used settings.



To open or close the **Text** menu.

In the Text menu, access teletext for news and information.



To open or close the **Options** menu.

Options menus offer convenient settings for TV channels or programmes.



To return to the previous menu page or to exit from a TV function.

Press and hold to return to watching TV.

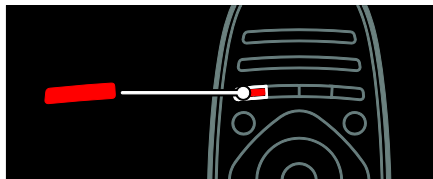

To select a red menu option, access digital Interactive TV services\*, or watch TV demonstration clips.

\*Available on certain models only.

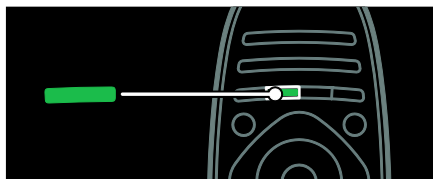

To select a green menu option or to access energy efficient settings.

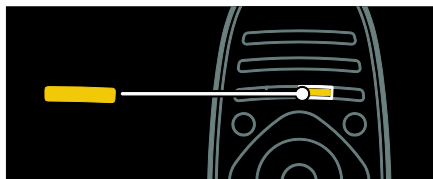

To select a yellow menu option or to access the electronic user manual.

Read more about the remote control in **Use your TV > Controls > Remote control** (Page 11).

Alternatively, look at the index in **Search for...**

Press ▲ to select the next TV tour.

## Connect devices

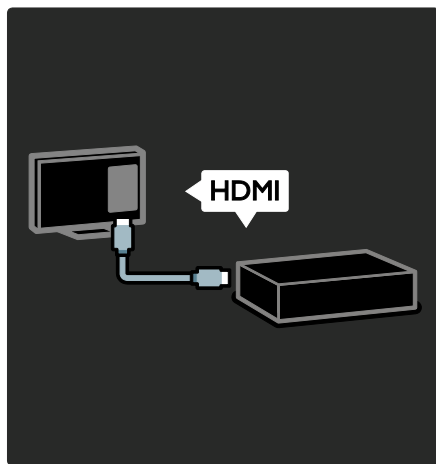

For the best picture and sound quality, connect a DVD, Blu-ray disc player, or game console through HDMI (TM).

To watch a non EasyLink compliant device, add it to the Home menu.

1. Press **⬆** > **[Add your devices]**.
2. Follow the onscreen instructions.

Note: If you are prompted to select the TV connection, select the connector that this device uses. See **Connect your TV > Connect devices** (Page 44) for information on connection.

If an EasyLink or HDMI-Consumer Electronic Control (HDMI-CEC) compliant device is connected to the TV, it is automatically added to the Home menu when both devices are switched on.

To watch a connected device

1. Press **⬆**.
2. Select the newly added device icon.

You can learn more on device connections in **Connect your TV > Connect devices**.

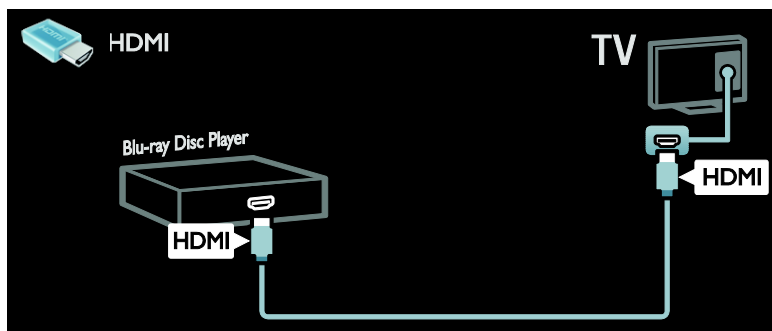

## High Definition TV

For high-definition (HD) picture quality, watch HD programmes.

On standard-definition (SD) programmes, the picture quality is standard.

You can watch HD video content in these ways and more:

- a Blu-ray disc player, connected with an HDMI cable, playing a Blu-ray disc
- an upscaling DVD player, connected with an HDMI cable, playing a DVD disc
- an over-the-air HD broadcaster (DVB-T MPEG4)
- a digital HD receiver, connected with an HDMI cable, playing HD content from a cable or satellite operator
- an HD channel on your DVB-C network
- an HD game console (for example, X-Box 360 or PlayStation 3), connected with an HDMI cable, playing an HD game

### HD video clip

To experience the stunning sharpness and picture quality of HD TV, watch the HD video clip from the Home menu.

Press **Home** > **[Setup]** > **[Watch demos]**.

**Watch Demo** is on the second page of the setup menu.

For more information about the availability of HD channels in your country, contact your Philips dealer or visit [www.philips.com/support](http://www.philips.com/support).

## Ambilight

\*Available on certain models only.

Ambilight gives a more relaxed viewing experience. It automatically adjusts the colour and brightness of the light to match the TV picture.

Read more in **Use your TV > Ambilight** (Page 18).

## Network

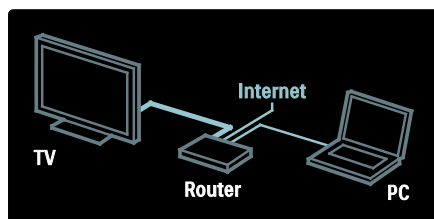

Connect your TV to your home network to play music, photos, and videos from a computer or other media server on the same network.

Read more in **Connect your TV > Computers and the Internet** (Page 51).

## Net TV

If your home network is connected to the Internet, you can connect your TV to **Net TV**. Net TV offers movies, pictures, music and much more.

Read more in **Use your TV > Browse Net TV** (Page 21).

---

## 3D TV

This is a 3D TV. Connect your TV to a 3D Blu-ray disc player or tune in to a TV channel that broadcasts programmes in 3D. Read more in [Use your TV > Watch 3D](#) (Page 17).

---

## Important

---

### Safety

Read and understand all instructions before you use your TV. If damage is caused by failure to follow instructions, the warranty does not apply.

#### Risk of electric shock or fire!

- Never expose the TV to rain or water. Never place liquid containers, such as vases, near the TV. If liquids are spilt on or into the TV, disconnect the TV from the power outlet immediately. Contact Philips Consumer Care to have the TV checked before use.
- Never insert objects into the ventilation slots or other openings on the TV.
- When the TV is swivelled, ensure that no strain is exerted on the power cord. Strain on the power cord can loosen connections and cause arcing.
- Never place the TV, remote control or batteries near naked flames or other heat sources, including direct sunlight. To prevent the spread of fire, keep candles or other flames away from the TV, remote control and batteries at all times.



#### Risk of short circuit or fire!

- Never expose the remote control or batteries to rain, water or excessive heat.

- Avoid force coming onto power plugs. Loose power plugs can cause arcing or fire.

#### Risk of injury or damage to the TV!

- Two people are required to lift and carry a TV that weighs more than 25kg or 55lbs.
- When stand mounting the TV, use only the supplied stand. Secure the stand to the TV tightly. Place the TV on a flat, level surface that can support the combined weight of the TV and the stand.
- When wall mounting the TV, use only a wall mount that can support the weight of the TV. Secure the wall mount to a wall that can support the combined weight of the TV and wall mount. Koninklijke Philips Electronics N.V. bears no responsibility for improper wall mounting that result in accident, injury or damage.
- Before you connect the TV to the power outlet, ensure that the power voltage matches the value printed on the back of the TV. Never connect the TV to the power outlet if the voltage is different.
- Parts of this product may be made of glass. Handle with care to avoid injury and damage.

#### Risk of injury to children!

Follow these precautions to prevent the TV from toppling over and causing injury to children:

- Never place the TV on a surface covered by a cloth or other material that can be pulled away.
- Ensure that no part of the TV hangs over the edge of the surface.
- Never place the TV on tall furniture, such as a bookcase, without anchoring both the furniture and TV to the wall or a suitable support.
- Educate children about the dangers of climbing on furniture to reach the TV.

**Risk of swallowing batteries!**

- The product/remote control may contain a coin-type battery, which can be swallowed. Keep the battery out of reach of children at all times!

**Risk of overheating!**

- Never install the TV in a confined space. Always leave a space of at least 4 inches or 10 cm around the TV for ventilation. Ensure that curtains or other objects never cover the ventilation slots on the TV.

**Risk of injury, fire or power cord damage!**

- Never place the TV or any objects on the power cord.
- To easily disconnect the TV power cord from the power outlet, ensure that you have full access to the power cord at all times.
- When you disconnect the power cord, always pull the plug, never the cable.
- Disconnect the TV from the socket and aerial before lightning storms. During lightning storms, never touch any part of the TV, power cord or aerial cable.

**Risk of hearing damage!**

- Avoid using earphones or headphones at high volumes or for prolonged periods of time.

**Low temperatures**

- If the TV is transported in temperatures below 5°C or 41°F, unpack the TV and wait until the TV temperature matches room temperature before connecting the TV to the power outlet.

**Screen care**

- Risk of damage to the TV screen! Never touch, push, rub or strike the screen with any object.
- Unplug the TV before cleaning.
- Clean the TV and frame with a soft damp cloth. Never use substances such as alcohol, chemicals or household cleaners on the TV.
- To avoid deformations and colour fading, wipe off water drops as soon as possible.

- Avoid stationary images as much as possible. Stationary images are images that remain onscreen for extended periods of time. Stationary images include onscreen menus, black bars, time displays, etc. If you must use stationary images, reduce screen contrast and brightness to avoid screen damage.

**3D, health warning**

- If you or your family have a history of epilepsy or photosensitive seizures, consult a medical professional before exposing yourself to flashing light sources, rapid image sequences or 3D viewing.
- To avoid discomfort such as dizziness, headache or disorientation, we recommend not watching 3D for extended periods of time. If you experience any discomfort, stop watching 3D and do not immediately engage in any potentially hazardous activity (for example driving a car) until your symptoms have disappeared. If symptoms persist, do not resume watching 3D without consulting a medical professional first.
- Parents should monitor their children during 3D viewing and ensure they do not experience any discomfort as mentioned above. Watching 3D is not recommended for children under 6 years of age as their visual system is not fully developed yet.
- Do not use the 3D glasses for any purpose other than watching 3D TV.

**Care of 3D glasses**

3D glasses are supplied with this TV. Follow these care instructions for your glasses:

- Use a clean soft cloth (microfibre or cotton flannel) to clean the lenses to avoid scratching them. Never spray cleaner directly on the 3D glasses. You can use pre-moistened cleaning cloths from most well-known lens manufacturers of sunglasses.

- Do not expose the 3D glasses to direct sunlight, heat, fire or water. This may result in a product malfunction or fire.
- Do not drop, bend or apply force to the lenses of the 3D glasses.
- Do not use cleaning chemicals containing alcohol, solvent, surfactant, or wax, benzene, thinner, mosquito repellent or lubricant. Using these chemicals can cause discolouration or cracks.
- CHOKING HAZARD - Keep the product out of reach of children under three years of age at all times! The product contains small parts which can be swallowed.

- **Light sensor:** The built-in ambient light sensor lowers the brightness of the TV screen when the surrounding light darkens.
- **Low standby power:** The advanced power circuitry brings down the power consumption of the TV to an extremely low level, without losing out on the constant standby functionality.
- **Power management:** The advanced power management of this TV ensures the most efficient use of its energy. To view how your personalised TV settings affect the TV's relative power consumption, press **⬆** and select **[Setup] > [Watch demos] > [Active Control]**.

---

## Environmental efforts

---

### Energy efficiency

Philips continuously focuses on lowering the environmental impact of our innovative consumer products. We aim our efforts towards environmental improvements during manufacturing, reduction of harmful substances, energy-efficient use, end-of-life instructions and product recycling.

#### To access energy efficient settings:

While you watch TV, press the **green** button on the remote control.

These energy-efficient settings include:

- **Energy saving picture settings:** You can apply a combination of energy saving picture settings. While you watch TV, press the **green** button and select **[Energy saving]**.
- **Power switch:** You can completely cut off power to the TV with the power switch. It is located at the base of the set.
- **Screen off:** If you only want to listen to audio from the TV, you can turn off the TV display. Other functions continue to operate normally.

---

### End of use

Your product is designed and manufactured with high quality materials and components, which can be recycled and reused.

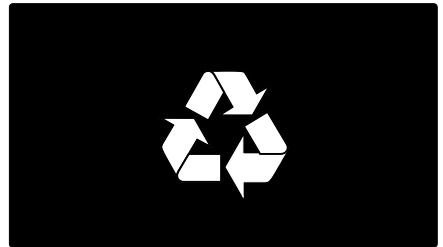

When this crossed-out wheeled bin symbol is attached to a product it means that the product is covered by the European Directive 2002/96/EC. Please inform yourself about the local separate collection system for electrical and electronic products.

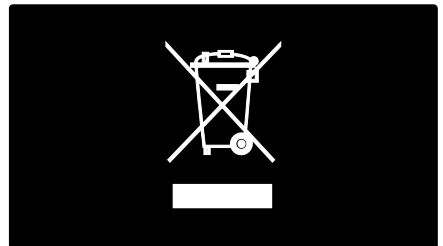



Please act according to your local rules and do not dispose of your old products with your normal household waste. Correct disposal of your old product helps to prevent potential negative consequences for the environment and human health.

Your product contains batteries covered by the European Directive 2006/66/EC, which cannot be disposed of with normal household waste. Please inform yourself about the local rules on separate collection of batteries because correct disposal helps to prevent negative consequences for the environment and human health.

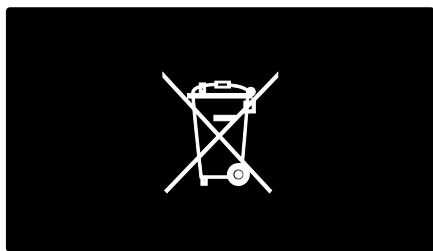

## Position the TV

### Placement

- Before you position the TV, read all safety precautions. See **Get Started > Important > Safety** (Page 6).
- Position the TV where light does not shine directly on the screen.
- The ideal distance from which to watch TV is three times its diagonal screen size. For example, if the diagonal screen size of the TV is 116cm / 46", the ideal viewing distance is ~3.5m / ~138" from the front of the screen.
- While seated, your eyes should be level with the centre of the screen.

### Stand mount or wall mount

To apply the best settings for your TV, select wall mount or stand mount.

1. In the **[Preferences]** menu, select **[TV placement]**.
2. Select **[On a TV stand]** or **[Wall mounted]**, then press **OK**.

### Wall mount

You can also wall mount your TV on a compatible TV mount (not supplied). Check your TV screen size and match it against the list for the type of wall mount to purchase:

- 81 cm / 32 inches** : 200mm x 200mm, M6
- 94 cm / 37 inches**: 200mm x 200mm, M6
- 107 cm / 42 inches**: 400mm x 400mm, M6
- 119 cm / 47 inches**: 400mm x 400mm, M6
- 140 cm / 55 inches**: 400mm x 400mm, M8

**Warning:** Follow all instructions provided with the TV mount. Koninklijke Philips Electronics N.V. bears no responsibility for improper TV mounting that results in accident, injury or damage.

To prevent damage to cables and connectors, leave a gap of at least 5.5 cm / 2.2 inches from the back of the TV.

### For 32-inch to 42-inch TVs:

Before you wall mount the TV, find the correct length of screw.

To find the length of screw, add the thickness of your wall mount to the screw length, as shown in the graphic.

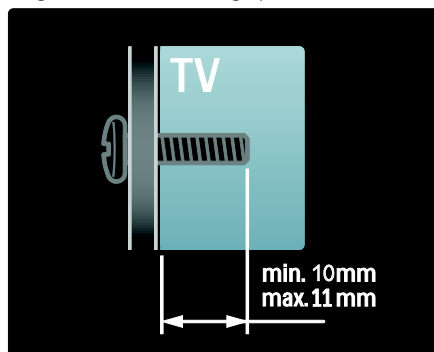

## For 47 inch to 55 inch TVs:

Before you wall mount the TV, find the correct length of screw.

To find the length of screw, add the thickness of your wall mount to the screw length, as shown in the graphic.

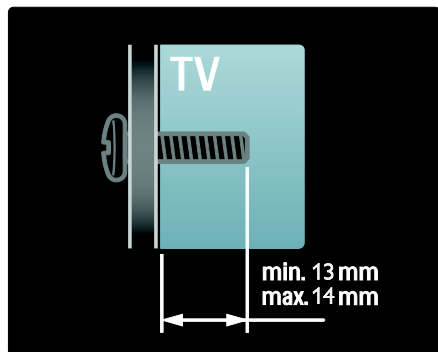

## Location

A range of TV settings are applied to suit the location of the TV.

### Shop or home mode

Set the TV location to **Home** mode to access all TV settings. In **Shop** mode, you can access only a few settings.

1. While you watch TV, press **Home**.
2. Select **[Setup]** > **[TV settings]** > **[Preferences]**.
3. Select **[Location]** > **[Home]** or **[Shop]**, then press **OK**.
4. Restart the TV.

## Lock the TV

Your TV is equipped with a Kensington security slot at the base of the TV. Purchase a Kensington anti-theft lock (not supplied) to secure the TV.



# Help and support

## Use Help

You can access onscreen **[Help]** from the Home menu by pressing the Yellow button.

You can also switch between the **[Help]** menu and the TV menu by pressing the Yellow button.

## Online support

If you can't find what you need in the onscreen **[Help]**, consult our online support at [www.philips.com/support](http://www.philips.com/support).

Follow the website instructions to select your language, then enter your product model number.

At our support website, you can also:

- find answers to frequently asked questions
- download a printable PDF version of this user manual to read
- email us a specific question
- chat online with one of our support personnel (available in certain countries only)

## Contact Philips

If you like, you can contact Philips Consumer Care in your country for support. You can find the contact number in the leaflet accompanying the TV.

Before you contact Philips, note down your TV model and serial number. You can find this information on the back of your TV or on its packaging.

## 2 Use your TV

### Controls

#### TV controls

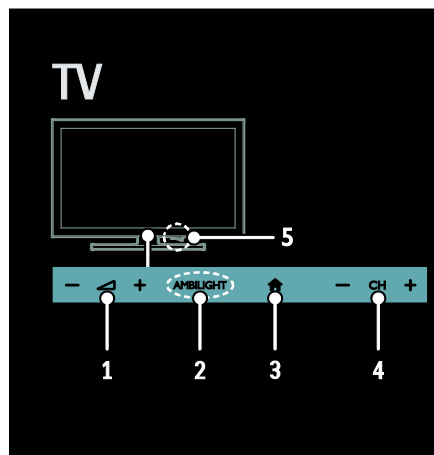

1. +/-: Increase or decrease volume.
2. **AMBILIGHT**: Switch Ambilight on or off. Ambilight is available on certain models only.
3. (Home): Access the Home menu. Press again to launch an activity in the Home menu. Confirm an entry or selection.
4. **CH +/-**: Switch to the next or previous channel.
5. **Power**: Switch the TV on or off.

### Indicators

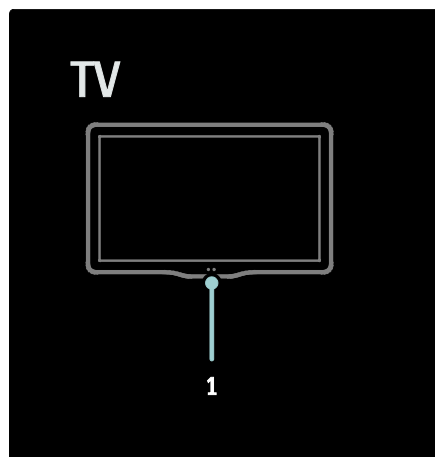

1. **Ambient sensor / remote control sensor**  
Ambient sensor is available on certain models only.

### Remote control

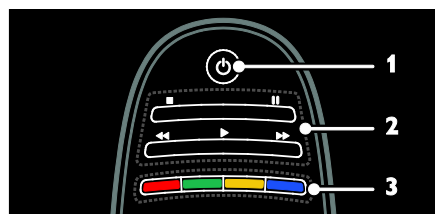

1. (Standby): Switch the TV on or to standby.
2. **Play buttons**: Control video or music play.
3. **Colour buttons**: Select tasks or options. Not supported in MHEG mode.

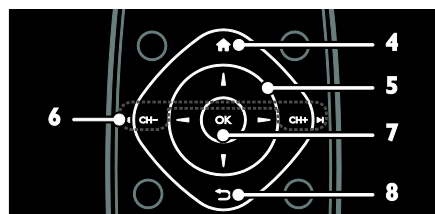

- 4. **⬆️ (Home)**: Access the Home menu.
- 5. **⬆️⬆️⬆️⬆️ (Navigation buttons)**: Navigate through menus and select items.
- 6. **⬅️ CH - / CH + ⬆️ (Previous/Next)**: Switch channels, navigate through menu pages, tracks, albums or folders.
- 7. **OK**: Confirm an entry or selection.
- 8. **⬅️ (Back)**: Return to the previous menu page or exit from a TV function.

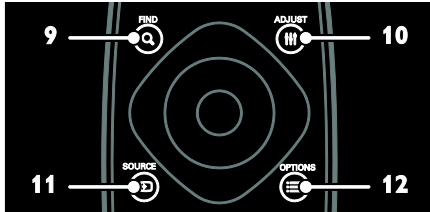

- 9. **Q FIND**: Access the menu to select TV channel list.
- 10. **⏸️ ADJUST**: Access the menu to adjust settings.
- 11. **📺 SOURCE**: Select connected devices.
- 12. **☰ OPTIONS**: Access options for the current activity or selection.

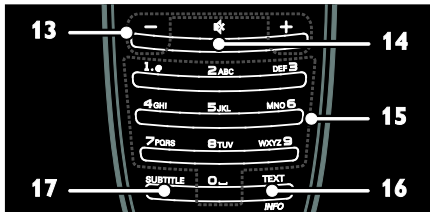

- 13. **+/- (Volume)**: Adjust volume.
- 14. **★ (Mute)**: Mute or restore audio.
- 15. **0-9 (Numeric buttons)**: Select channels.
- 16. **TEXT/INFO**: Enable or disable teletext. Press and hold to view more information on the current activity.
- 17. **SUBTITLE**: Enable or disable subtitles.

## Batteries

**Warning:** Risk of swallowing batteries!  
 The product/remote control may contain a coin-type battery, which can be swallowed. Keep the battery out of reach of children at all times!

**Caution:** The battery contains perchlorate material, handle it with care. For information, see [www.dtsc.ca.gov/hazardouswaste/perchlorate](http://www.dtsc.ca.gov/hazardouswaste/perchlorate).

If your remote control signal is weak, replace the batteries:

1. Open the battery cover.
  2. Remove the old batteries from the battery compartment, and replace them with fresh batteries.
- Make sure that the ends of the batteries line up correctly with the +/- markings in the battery compartment.

### Notes:

Dispose of batteries according to environmental directives. Read **Get started > Environmental efforts > End of use** (Page 8).  
 Remove batteries from the remote control if you will not use it for an extended period of time.

The type of battery varies according to RC model:

For remote control with AAA batteries (end to end):

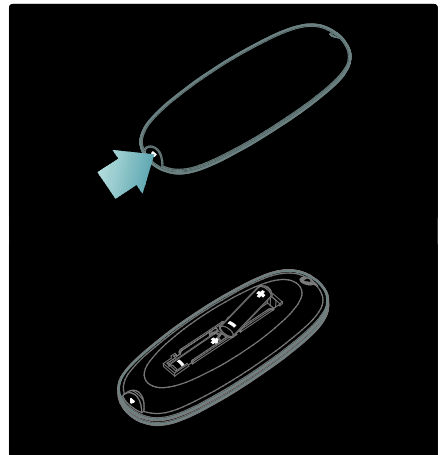

For remote control with AAA batteries (side by side):

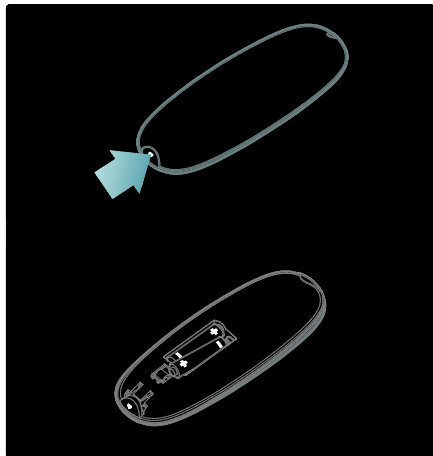

For remote control with coin cell batteries:

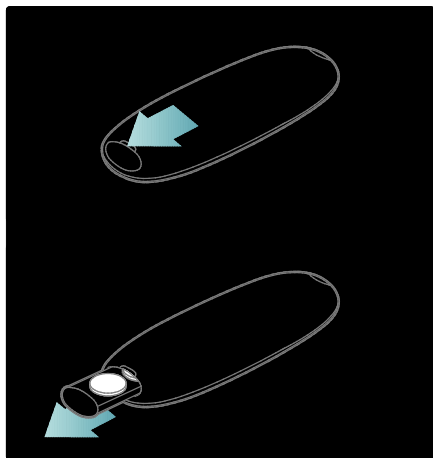

## EasyLink controls

**Note:** EasyLink controls are available when the connected device is HDMI-CEC compliant.

EasyLink allows you to control your TV and other HDMI-CEC devices with one remote control.

## Access EasyLink controls

1. While you view content from a connected HDMI-CEC device, press **≡** **OPTIONS**.
2. Select **[Show device keys]**, then press **OK**.
3. Select the EasyLink control button, then press **OK**.

Read more on EasyLink in **Use more of your TV > Use EasyLink** (Page 32).

## Smartphone control

Use your iPhone as a secondary remote, and even as a keyboard. Go to the Apple Apps store and download the application '**Philips Wifi TV Remote**'. Follow the instructions provided at the Apps store.

Ensure that your TV is connected to the same network as your iPhone. Read more about network connections in **Connect your TV > Computers and the Internet** (Page 51).

## Watch TV

### Switch TV on or off

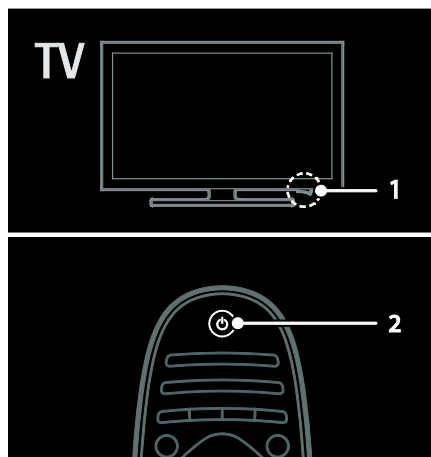

### Switch the TV on

- Press the power switch at the base of the TV to the **ON** position.
- If the TV is in standby, press **⏻** on the remote control.

Note: There is a short delay before the TV responds.

Tip: If you cannot find your remote control and want to switch on the TV from standby, press **CH +/-** on the front of the TV.

Though your TV consumes very little energy in standby, it does use some energy. If you are not going to use the TV for an extended period of time, switch it off to cut off the power.

### Switch TV to standby

Press **⏻** on the remote control. The remote control sensor on the TV switches to red.

### Switch off the TV

Press the power switch at the base of the TV to the **OFF** position.

The TV no longer consumes energy.

### Automatic switch off

This TV is designed with energy efficiency settings. If there is no user interaction (such as pressing a remote control button or a control on the front panel) for four hours, the TV will automatically switch to standby.

### To disable automatic switch off,

While you watch TV, press the green button on the remote control. Select **[Auto switch off]** and press **OK**. An on screen message confirms that automatic switch off is disabled.

---

## Adjust TV volume

### Increase or decrease the TV volume

- Press **+/-** on the remote control.

- Press **◀ +/-** on the front of the TV.

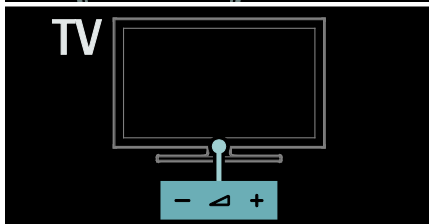
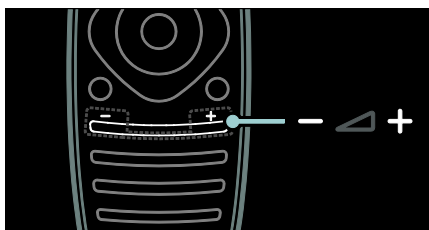

### Mute or unmute the TV volume

- Press **⏻** to mute the TV, or
- Press **⏻** again to restore the volume.

### Adjust headphone volume

1. Press **🏠** > **[TV settings]** > **[Sound]**.
2. Select **[Headphones volume]**, then press **OK**.

---

## Switch TV channels

- Press **◀▶** on the remote control.
- Press **CH +/-** on the TV.
- Press the **Numeric buttons** to enter a channel number.

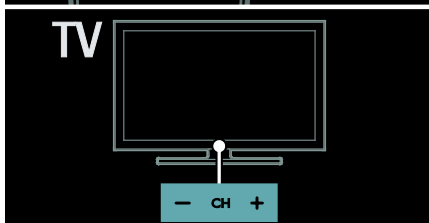
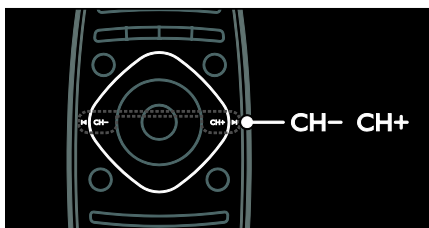

---

## Manage channel lists

You can view all channels, or only your favourites in the channel list.

Press **Q FIND** to access the channel list.

### Create a channel list

You can create a channel list that contains only your favourite channels.

1. Press **Q FIND**.
2. Press **≡ OPTIONS**.
3. Select **[Mark as favourite]** or **[Unmark as favourite]**, then press **OK**.

### Select a channels list

1. In the channel list, press **≡ OPTIONS**.
2. Select **[Select list] > [Favourites]** to display channels in the favourite list; or **[All]** to display all channels.
3. Press **OK** to confirm.

### View only analogue or digital TV channels

You can filter the channel list to access only analogue or digital channels.

1. In the channel list, press **≡ OPTIONS**.
2. Select **[Select list] > [Analogue]** or **[Digital]**, then press **OK**.

Depending on your selection, only analogue or digital channels are available.

### Listen to digital radio

If digital radio channels are available, they are installed automatically when you install the TV channels.

1. While you watch TV, press **Q FIND**. The channel list is displayed.
2. Press **≡ OPTIONS**.
3. Select **[Select list] > [Radio]**, then press **OK**.
4. Select a radio channel, then press **OK**.

---

## View programme guide

The programme guide displays information about digital TV channels, for example:

- Channel schedules
- Synopsis of programmes

**Note:** TV programme guides are available in certain countries only.

## Set programme guide

Before you use the programme guide, check the following settings:

1. Press **⬆**.
2. Select **[Setup] > [TV settings] > [Preferences]**.
3. Select **[Programme guide] > [From the broadcaster]**, then press **OK**.

### Access the TV programme guide

1. Press **⬆**.
2. Select **[Programme guide]**, then press **OK**.

**Note:** If you are viewing the programme guide for the first time, select **[Update Programme guide]** to update all available programmes.

### Use TV programme guide options

You can customise the displayed information to:

- Remind you when programmes start
- Display only preferred channels

1. In the programme guide, press **≡ OPTIONS**.

2. Select one of these settings, then press **OK**:

- **[Set reminder]:** Set programme reminders.
- **[Clear reminder]:** Clear programme reminders.
- **[Change day]:** Select the day to display.
- **[More info]:** Display programme information.
- **[Search by genre]:** Search TV programmes by genre.
- **[Scheduled reminders]:** List programme reminders.
- **[Update Programme guide]:** Update the latest programme information.

---

## Use smart picture settings

Select your preferred picture setting.

1. While you watch TV, press **≡ OPTIONS**.
2. Select **[Smart picture]**.
3. Select one of the following settings, then press **OK**:

- **[Personal]:** Apply your personalised picture settings.

- **[Vivid]**: Rich and dynamic settings, ideal for daytime viewing.
- **[Natural]**: Natural picture settings.
- **[Cinema]**: Ideal settings for movies.
- **[Game]**: Ideal settings for games.
- **[Energy saving]**: Settings that conserve the most energy.
- **[Standard]**: Default settings that suit most environments and types of video.
- **[Photo]**: Ideal settings for photos.
- **[Custom]**: Customise and store your own picture settings.

---

## Use smart sound settings

Select your preferred sound setting.

1. While you watch TV, press **≡** **OPTIONS**.
2. Select **[Smart sound]**.
3. Select one of the following settings, then press **OK**:
  - **[Personal]**: Apply your preferred setting in the **Sound** menu.
  - **[Standard]**: Settings that suit most environments and types of audio.
  - **[News]**: Ideal settings for spoken audio, such as the news.
  - **[Movie]**: Ideal settings for movies.
  - **[Game]**: Ideal settings for games.
  - **[Drama]**: Ideal settings for drama programs.
  - **[Sports]**: Ideal settings for sports.

---

## Change picture format

Change the picture format to suit your preference.

1. Press **≡** **ADJUST**.
2. Select **[Picture format]**, then press **OK**.
3. Select a picture format, then press **OK** to confirm.

The available picture formats depend on the video source:

- **[Auto fill]**: Adjust the picture to fill the screen (subtitles remain visible). Recommended for minimal screen distortion but not for HD or PC.
- **[Auto zoom]**: Enlarge the picture to fill the screen. Recommended for minimal screen distortion but not for HD or PC.

- **[Super zoom]**: Remove the black bars on the sides of 4:3 broadcasts. Not recommended for HD or PC.
- **[Movie expand 16:9]**: Scale 4:3 format to 16:9. Not recommended for HD or PC.
- **[Wide screen]**: Stretch 4:3 format to 16:9.
- **[Unscaled]**: Provide maximum detail for PC. Only available when PC mode is enabled in the picture menu.

---

## Watch a connected device

---

### Add new device

**Notes:**

- Before you watch a connected device, you must add its icon to the Home menu. See **Connect your TV > Connect device** (Page 44).
- If you connect an HDMI-CEC compliant device to the TV through an HDMI connector and switch it on, the device is automatically added to the Home menu.

1. Connect and switch on the device.
2. Press **⬆**.
3. Select **[Add your devices]**, then press **OK**.
4. Follow the onscreen instructions.
  - Select your device.
  - Select the connector.

Note: If you are prompted to select the TV connection, select the connector that this device uses.

---

### Select a source

#### From Home menu

After you have added the new device to the Home menu, select the new device icon to view its contents.

1. Press **⬆**.
2. Select the device icon from the Home menu.
3. Press **OK** to confirm.



## From Source menu

You can also press **SOURCE** to display a list of connector names. Select the connector that connects the device to the TV.

1. Press **SOURCE**.
2. Press the **Navigation buttons** to select a connector in the list.
3. Press **OK** to confirm.

---

## Play from USB

If you have photos, videos or music files on a USB storage device, you can play the files on TV.

**Caution:** Philips is not responsible if the USB storage device is not supported, nor is it responsible for damage or loss of data in the device.

Do not overload the USB port. If you connect an HDD device that consumes more than 500mA power, make sure that it is connected to its own external power supply.

Access the USB content browser as follows:

- While you watch TV, connect the USB device to the USB connector on the TV.
- Press **Home**, select **[Browse USB]**, then press **OK**.

### Watch video

Press the **Navigation buttons** to select a video file, then press **OK**.

- Press **Left** or **Right** to search forward or backward within a video.
- Press and hold **Back** to exit the content browser.

While you play video, press **Options** to access the following video options:

- **[Stop]:** Stop playback.
- **[Repeat]:** Repeat a video.
- **[Shuffle on] / [Shuffle off]:** Enable or disable random play of videos.

### View picture

Press the **Navigation buttons** to select a picture, then press **OK**.

- To pause or stop play, press **OK**.

- To skip to the previous or next file, press **Left** or **Right**.
- Press and hold **Back** to exit content browser.

Press **Options** to access or exit the following picture options:

- **[Show info]:** Display the file information.
- **[Stop]:** Stop slideshow.
- **[Rotate]:** Rotate the file.
- **[Repeat]:** Repeat the slideshow.
- **[Play once]:** Play the file once.
- **[Shuffle off] / [Shuffle on]:** Enable or disable random display of pictures in the slideshow.
- **[Slideshow speed]:** Set the display time for each picture in the slideshow.
- **[Slideshow transition]:** Set the transition from one picture to the next.
- **[Set as Scenea]:** Set the selected picture as wallpaper on TV.

### Listen to music

Press the **Navigation buttons** to select a music track, then press **OK**.

- Press **Left** / **Right** to search forward or backward within a track.
- Press and hold **Back** to exit content browser.

Press **Options** to access or exit the following music options:

- **[Stop]:** Stop audio play.
- **[Repeat]:** Repeat a track or an album.
- **[Play once]:** Play the track once.
- **[Shuffle on] / [Shuffle off]:** Enable or disable random play of tracks.

---

## Watch 3D

### What you need

Your TV is a 3D TV. To watch 3D, you can use the Philips Easy 3D glasses, included with this TV. You can purchase additional Philips 3D glasses PTA416 (sold separately) from your local dealer.

Before you watch 3D, read the health warning information in **Get started > Important > 3D Health warning** (Page 7).

**Note:** Passive 3D glasses from other manufacturers may not work or offer less optimal 3D viewing.

---

## Start 3D

To enjoy a 3D movie or programme, insert a 3D movie disc into the 3D Blu-ray disc player connected to the HDMI connector on this TV or tune to a TV channel that broadcasts 3D content.

Press **Home** and select the 3D Blu-ray disc player or select **[Watch TV]** and tune to the TV channel.

The TV will prompt a message when 3D is available. To start watching 3D, select **[Start 3D]** and press **OK**. Put on your 3D glasses.

If you have tuned to a 3D TV channel and do not see the prompt to switch to 3D, you have to select the 3D format manually.

### Select a suitable 3D format

If the TV shows a double picture but the 3D effect is not seen with the 3D glasses, you will need to select a suitable 3D viewing format.

To set the TV in 3D, press **Menu** **ADJUST**. Select **[3D format]** and press **OK**, then select **[3D - Side by side]** or **[3D - Top / bottom]** according to the double picture positions.

**Note:** Some 3D formats are not supported. The TV does not support 3D input from its USB connection and Net TV.

---

## Stop 3D

If you switch to another channel or a connected device, the TV switches back to 2D.

To stop watching 3D during a 3D programme, press **Menu** **ADJUST**. Select **[2D/3D] > [2D]**, then press **OK**. This forced 2D picture shows only the 3D-left picture.

**Note:** The 2D/3D menu is only available when the TV receives 3D content from the input signal, or when **[3D format]** has been set to **[3D - Side by side]** or **[3D - Top / bottom]**.

---

## Optimal 3D viewing

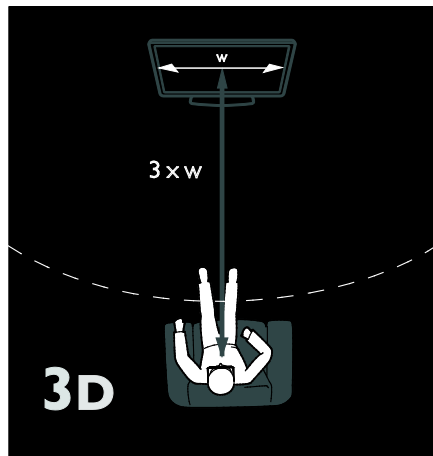

For an optimal 3D viewing experience, we recommend that you:

- sit at a distance that is at least three times the width (W) of the TV screen. Do not sit more than six metres away.
- view the centre of the TV screen at your eye level.
- watch the TV away from direct sunlight as it may interfere with the 3D experience.

---

## Ambilight

---

### What you can do

\*Available on certain models only.

Ambilight gives a more relaxed viewing experience. It automatically adjusts the colour and brightness of the light to match the TV picture.

## What you need

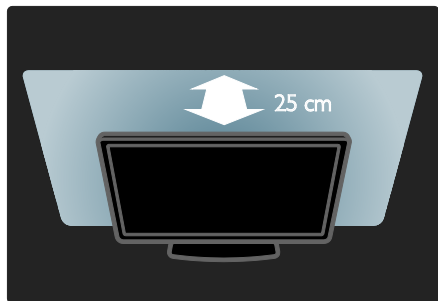

- For the best Ambilight effect, position the TV 25cm away from the wall.
- Keep the remote control away from the TV, as it can interfere with the infrared signals.
- Dim the light in the room.

## Switch on

1. Press **ADJUST**.
2. Select **[Ambilight]**, then press **OK**.
3. To switch Ambilight on or off, select **[On]** or **[Off]**.

You can also press **AMBILIGHT** on the TV to switch Ambilight on or off.

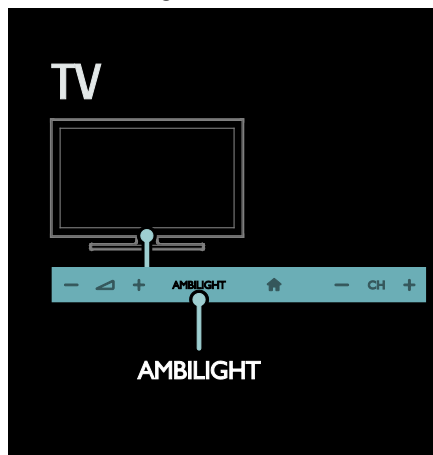

## Change settings

In the Ambilight menu, you can access more Ambilight settings.

1. While you watch TV, press **HOME** > **[Setup]**.
2. Select **[TV settings]** > **[Ambilight]**.
3. Select a setting to adjust:
  - **[Dynamic]**: Adjust Ambilight between relaxed and dynamic levels. Available only if Ambilight **[Colour]** is set to **[Dynamic]**.
  - **[Brightness]**: Adjust the brightness of Ambilight.
  - **[Colour]**: Select a predefined colour.
  - **[Custom colour]**: Set your own Ambilight colour. To access this option, set **[Ambilight]** > **[Colour]** > **[Custom]**.
  - **[Separation]**: Adjust the difference in colour levels on each side of the TV. Turn off this feature for a dynamic and uniform Ambilight colour.
  - **[TV switch off]**: Select how Ambilight switches off when the TV is switched off.
  - **[Lounge light mood]**: Select a lounge light mode. The lounge light comes on when the TV is in standby.
  - **[Scenea lounge light]**: Switch Scenea lounge light on or off when Scenea is enabled.
  - **[Wall colour]**: Select the colour of the wall behind the TV. Ambilight corrects its colours to suit the colour of the wall.

## Use lounge light

When the TV is in standby, press **Ambilight** on the front of the TV to create a lounge light effect in your room.

**Note:** It may take more than 5 seconds for the lounge light to switch on.

To select another lounge light colour, see **Use your TV > Ambilight > Setup** (Page 19).

---

# Browse PC through DLNA

---

## What you can do

If you have photos, videos or music files stored on a computer connected through a home network, you can play the files on your TV.

---

## What you need

- A wired or wireless home network, connected with a Universal Plug and Play (uPnP) router.
- A Philips wireless USB adapter or a LAN cable that connects your TV to your home network.
- A media server such as:  
PC running **Windows Media Player 11** or higher; or  
Mac running **Twonky Media Server**.
- Make sure that your computer firewall allows you to run the media server software program.

You will also need to set up the network connection:

- Connect your TV and the computer to the same home network. See **Connect your TV > Computers and the Internet (Page 51)**.
- Switch on your computer and the router.

Proceed to set up a media sharing server with Windows Media Player 11 or higher, or Twonky Media Server.

**Note:** For help to use other media servers, such as TVerseity, see the web site of the media server.  
If the apparatus does not return to DLNA mode due to external electrical disturbances (e.g. electrostatic discharge), user intervention is required.

---

## Enable sharing on Windows Media Player 11

1. Start **Windows Media Player** on your computer.
2. Select **Library > Media Sharing**.

- The first time you select **Media Sharing**, a pop-up screen appears. Tick the **Share my media box** and click **OK**.
- A device marked as **Unknown Device** appears in the **Media Sharing** screen. If the unknown device does not appear after a minute or so, make sure that your PC firewall is not blocking the connection.

3. From the **Media Sharing** screen, select the unknown device and click **Allow**.

A green tick appears next to the device.

- By default, **Windows Media Player** shares files from these folders: **My Music**, **My Pictures**, and **My Videos**.

4. If your files are in other folders, select **Library > Add to Library**, and then follow the onscreen instructions to add the folders.

- If necessary, select **Advanced options** to display a list of monitored folders.

5. Select **Library > Apply Media Information Changes** to activate the changes.

---

## Enable sharing on Windows Media Player 12

1. Start **Windows Media Player** on your computer.

2. In **Windows Media Player**, select the **Stream** tab, and then select **Turn on media streaming**.

The **Media streaming** options screen appears.

3. Click **Turn on media streaming**.

Return to the Windows Media Player screen.

4. Click **Stream > More streaming options**.

- The **Media streaming options** screen appears.
- A media program appears in the local network screen. If the media programme does not appear, make sure that your PC firewall is not blocking the connection.

5. Select the media programme and click **Allowed**.

- A green arrow appears next to the media programme.

- By default, **Windows Media Player** shares files from these folders: **My Music**, **My Pictures**, and **My Videos**.
6. If your files are in other folders, select **Organize** tab and select **Manage libraries > Music**.
- Follow the onscreen instructions to add the folders that contain your media files.

---

## Enable sharing on Twonky Media

1. Visit [www.twonkymedia.com](http://www.twonkymedia.com) to purchase the software, or download a free 30-day trial to your Macintosh.
  2. Start **Twonky Media** on the Macintosh.
  3. In the **Twonky Media Server** screen, select **Basic Setup** and **First steps**. The **First steps** screen appears.
  4. Type a name for your media server, and then click **Save changes**.
  5. Back in the Twonky Media screen, select **Basic Setup > Sharing**.
  6. Browse and select folders to share, and then select **Save Changes**.
- Your Macintosh rescans the folders automatically so that they are ready to share.

---

## Play files from computer

**Note:** Before you play multimedia content from the computer, make sure that the TV is connected to the home network, and the media server software is properly set up.

1. Switch on the computer and the router.
2. Switch on your TV.
3. Press **⬆** on the remote control.
4. Select **[Browse PC]**, then press **OK**. If the network installation starts, follow the onscreen instructions.
5. If the content browser is displayed, select a file, then press **OK**.

The file starts to play.

6. Press the **Play buttons** on the remote control to control play.

### View pictures

- To play a picture slideshow, select a photo, then press **OK**.
- To pause or stop playback, press **OK** again.

- To play the previous or next file, press **⏮** or **⏭**.

Press **☰ OPTIONS** to access one of the following options:

- **[Show info]**: Display the file information.
- **[Stop]**: Stop slideshow.
- **[Rotate]**: Rotate the file.
- **[Repeat]**: Repeat the slideshow.

---

## Browse Net TV

---

### What you can do

Enjoy Internet Applications (Apps), specially adapted internet websites for your TV. You can control the Apps with the TV remote control. For example, you can:

- Read newspaper headlines
- Watch videos
- Check weather forecasts

Use the catch-up TV feature to watch TV programmes that you missed. Availability of catch-up TV Apps differ for each country. To find out which TV programmes are available, access the Net TV programme guide.

Find out more on Net TV services at the Net TV forum website, [www.supportforum.philips.com](http://www.supportforum.philips.com).

### Notes:

- Each country has different Net TV services.
- Certain websites may not display completely. Some functions are not available, for example file download, or functions that require plug-ins.
- Net TV services are updated automatically. To view the latest updates, change **All** to **New** in the **App store**.
- Net TV displays one page at a time, in full screen.
- Koninklijke Philips Electronics N.V. bears no responsibility regarding the content and the quality of the content provided by the content service providers.

---

## What you need

To enjoy Net TV, complete these tasks:

1. On your home network, connect the TV to the Internet
2. On your TV, configure Net TV.
3. On your PC, register with Philips to enjoy exclusive benefits and receive updates on product information. You can register now or later.

### Notes:

- You can lock Net TV Applications (Apps) with a 4 digit pin-code. All adult Apps can be locked as one selection.
- When you lock an adult Application, the advertisements and Web pages not adapted for Net TV remain accessible.

### Connect the TV to the Internet

On your home network, connect the following:

1. Connect a router with a high-speed connection to the Internet.
2. Switch on the router.
3. Install the network. See **Connect the TV > Computers and the Internet** (Page 51).

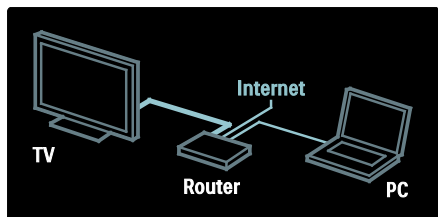

### Configure Net TV

1. Press **⬆**, select **[Browse Net TV]**, and then press **OK** to confirm.

The terms and conditions of use are displayed.

2. To agree to the terms and conditions, press **OK**. The registration menu is displayed.

3. To register with Club Philips, select **[Register]**, then press **OK**.

4. Confirm the onscreen message.

A prompt asks if you want to lock adult services.

5. To lock adult services, select **[Lock]**, then press **OK**.

To leave adult services unlocked, select **[Leave unlocked]**, then press **OK**.

6. To lock, enter a 4-digit code, then press **OK**.

7. Re-enter the 4-digit code, then press **OK**. The Net TV start page is displayed.

---

## Access Net TV Applications (Apps)

The first page shown is the Net TV home page. The icons on this page represent the applications (Apps).

- Browse Internet websites with the Internet Apps. Press the **Navigation buttons** to select an App, then press **OK** to confirm.
- Read the Net TV quick guide for more information.
- Access the App Gallery to add more Apps to your home screen.
- You can change country settings and select Apps from other countries.

### Access website

1. Select an Internet App, then press **OK**.
2. Use the **Numeric buttons** on the TV remote control to enter a web address.

### Onscreen keyboard

Select the area to enter the web address, then press **OK**.

A keyboard appears on the screen.

Use this to enter a web address.

### Clear Net TV memory

**Warning:** This option resets Net TV completely.

You can clear the Net TV memory completely, including your favourites, the parental control code, passwords, cookies and history.

1. Press **⬆**.
2. Select **[Setup] > [Network settings]**.
3. Select **[Clear Net TV memory]**, then press **OK**.

## Options

Press **≡ OPTIONS** to select the following:

- Remove App
- Lock App
- Unlock App
- Move App

### Show remote control

Keys such as play ▶, rewind ◀◀ and fast forward ▶▶ can be called up with **[Show remote control]**.

Press **≡ OPTIONS** and select **[Show remote control]**. Use the onscreen keys to operate the connected audio or video player.

Select a key and press **OK** to carry out its function. Press **⏏** to hide the onscreen keys.

Select **P+** and **P-** to scroll up and down on a web page.

### Zoom page

To zoom in and out on an Internet page, press **≡ OPTIONS** and select **[Zoom page]**. Use the slider bar to set the enlargement.

To scroll through an Internet page, use the **Navigation buttons** to jump from highlight to highlight.

### Reload page

If a page does not load correctly, reload it. Press **≡ OPTIONS** and select **[Reload page]**.

### Security info

To view security information about a page, press **≡ OPTIONS** and select **[Security info]**.

## Rent online video

### What you can do

With this TV, you can rent a video from an online video store.

1. Open a video store. You may need to register or enter your login.
2. Select a video.
3. Make the online payment.
4. Download a video.

## What you need

To rent and download a video, you need a high-speed Internet connection to the TV. Read more about network connections in **Connect your TV > Computers and the Internet** (Page 51).

You also need an SD memory card to insert into the TV SD card slot.

### SD memory size

Use a blank SD memory card of type SDHC class 6, with at least 4 GB of storage capacity.

For high-definition video, make sure that you use an SDHC card with at least 8 GB of storage capacity.

**Note:** If the write speed is insufficient for video transfer, the TV rejects the SD card.

**Caution:** This TV has a standard SD card slot that can be used only for renting video.

Follow the instructions described here. If you insert the card incorrectly, you might damage the card. All existing content on the SD card is erased before you download rented videos.

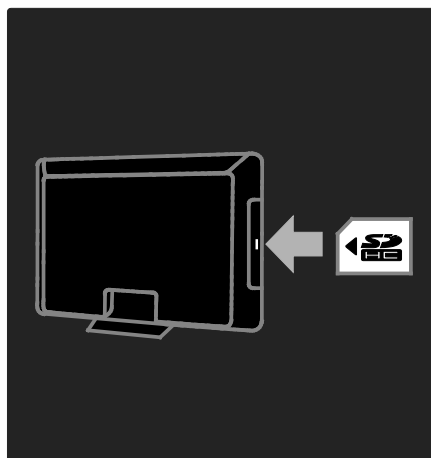

### Format an SD card

Before you download rented videos, your SD card must be formatted.

1. Switch on the TV.
2. As illustrated, insert the SD memory card into the SD card slot on the side of the TV. The TV automatically starts formatting the card.
3. After formatting, leave the SD card in the slot.

---

## Rent

### View a video store

1. Press **⬆**.
2. Select **[Browse Net TV]** and press **OK**.
3. Access the App Gallery to search for available video stores in your country.
4. Press the **Navigation buttons** to select a store, then press **OK** to confirm.

The icon of the video store is added to the home page.

5. To view a store, select its icon and press **OK**.

### Rent a video

To rent a video, select its icon on the video store page and press **OK**. In most cases you can rent a video for one day or for a couple of days or even just 1 hour. The way you select and rent a video varies from store to store.

### Payment

The store prompts you to log in or to open a new account if you do not have one. The login might consist of your email address and a personal PIN code. When you are logged in, you can select the payment method, a credit card, or a value code in most cases.

Consult the video store website for more information on its payment terms.

- To enter a number code (PIN), use the **Numeric buttons** on the remote control.
- To enter an email address, select the text field on the page and press **OK**. Select a character on the keyboard and press **OK** to enter.

### Download the video

When you have paid, you can download the video on to the video memory. During the download, you can continue to watch a TV programme until the TV notifies you that the video is ready to play.

If you cancel a download, you can still download the video until the rental period expires.

### Watch video

1. Press **⬆**, select **[Browse Net TV]**. The installed video stores are displayed.
2. Select the video store where you rented the video, then press **OK**.
3. With your log-in information, enter the online video store.
4. Select the video from the list of downloaded videos, then press **OK** to play.



## 3 Use more of your TV

### Enjoy HbbTV

#### What you can do

Some broadcasters of digital channels offer interactive HbbTV (Hybrid Broadcast Broadband TV).

With HbbTV, broadcasters combine their normal TV programme with all kinds of information or entertainment. You can browse this information interactively. You can respond to a programme or vote, do online shopping or pay for a video-on-demand programme.

To fully enjoy HbbTV, you need to connect your TV to the Internet. Read more about connecting the TV to the Internet in **Connect your TV > Computers and the Internet** (Page 51).

**Note:** You cannot download files to your TV with this feature.

#### Access HbbTV

When you tune to a TV channel that offers HbbTV, the interactive pages will open automatically or, at some point, you will be invited to open them.

Depending on the broadcaster, you might need to press the red button or **OK** on the remote control to access the page.

To exit the HbbTV pages, select the relevant button on screen and press **OK**.

#### Navigate HbbTV pages

To navigate the HbbTV pages, you can use the navigation buttons, colour buttons, number buttons, and the **↶** (back) button.

While you watch videos within HbbTV pages, you can use **▶** (play), **⏸** (pause) and **■** (stop) buttons.



#### HbbTV text

Some broadcasters offer HbbTV Text, a new version of Text. Depending on the broadcaster, you might need an Internet connection to view HbbTV Text.

You can use the same remote control buttons to navigate HbbTV Text as you did to navigate HbbTV pages.

#### Block HbbTV

You can block HbbTV completely.

To block HbbTV, press **≡** **OPTIONS** and select **[HbbTV on this channel] > [Off]**.

### Smart USB recording

#### What you can do

With this TV, you can pause a live TV broadcast from a digital channel. Connect a USB hard disk to your TV and you can pause the live broadcast.

If your TV is connected to the Internet, you can also set a programmed recording of a digital broadcast.

#### What you need

Smart USB recording and Pause TV work only with digital TV channels (DVB broadcast or similar).

To pause or record a digital broadcast, you need to connect a USB hard disk. Use a USB 2.0 compatible hard disk with a minimum of 250 GB hard disk space. Ensure that the USB hard disk supports a minimum transfer speed of 30MBps.

To record programmes with the USB hard disk device, ensure your TV is connected to the Internet. Read more about connecting the TV to the Internet in (Page 51).

To record programmes with the USB hard disk device, ensure your TV is connected to the Internet. Read more about connecting the TV to the Internet in (Page 51).

If you cannot connect to the Internet, you can still pause live TV broadcasts. To pause broadcasts, you need a USB hard disk with a minimum size of 32 GB hard disk space.

Connect the USB hard disk to the USB connector on the side of the TV. If you need extra USB connectors, use a USB hub.

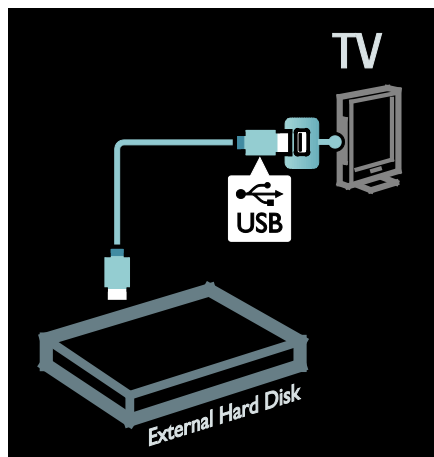

## Installation

**Caution:** Philips is not responsible if the USB hard disk device is not supported, nor is it responsible for damage or loss of data in the device.

Do not overload the USB port. If you connect an USB device that consumes more than 500mA power, make sure that it is connected to its own external power supply.

Once the USB hard disk device is formatted for this TV, you cannot use the recordings on another TV. Do not copy or change recording files on the USB hard disk through any PC application. This will corrupt your recordings.

Before you can pause or record a broadcast, you must format the connected USB hard disk device.

1. Connect the USB hard disk to one of the USB connectors on the side of the TV. Do not connect another USB device in the other USB connection when you are formatting the USB hard disk.
2. Switch on the device and the TV.
3. When the TV is tuned to a digital TV channel, press **||** (pause) to start formatting. Formatting removes all data from the connected USB hard disk device. Follow the instructions on screen.

When the USB hard disk is formatted, keep the device connected permanently.

---

## Pause live broadcast

While you watch a live TV broadcast on a digital channel, you can pause the broadcast and continue watching it later. You can pause TV to answer an urgent phone call or have a break without having to wait for the TV commercials. Meanwhile, the broadcast is stored on the USB hard disk.

**Note:** You can pause a broadcast for a maximum time span of 90 minutes.



- To pause a live TV broadcast, press **||** (pause). A progress bar appears briefly on screen.
- To continue watching, press **▶** (play).
- To switch to live TV broadcast again, press **■** (stop).

Once you switch to a digital channel, the USB hard disk starts storing the broadcast.

**The stored broadcast on the USB hard disk is cleared when:**

- you switch the TV to standby.

- you switch to another channel. The USB hard disk starts storing the content on the new channel broadcast.
- you start watching a programme from a connected device - a Blu-ray disc player or digital receiver.

While a programme is recording to the USB hard disk, you cannot pause a live TV broadcast.

### Instant replay

While you watch a live TV broadcast from a digital channel, you can replay the broadcast instantly.

**To replay the last 10 seconds of a live TV broadcast**, press **⏸** (pause) and press the left navigation button on the remote control.

**To jump back several steps of 10 seconds**, press the left navigation button repeatedly.

**To jump back to the beginning of the TV broadcast**, press the left navigation button repeatedly until you reach the beginning of the broadcast storage or the maximum timespan.

### Progress bar

To display the progress bar while you watch TV, press **⏸** (pause).

With the progress bar on screen, press **⏮** (reverse) or press **⏭** (forward) to select from where you want to start viewing the stored broadcast.

Press these buttons repeatedly to change their speed.

---

## Start recording

If your TV is connected to the Internet, you can record a TV programme onto the USB hard disk. Start and manage the recordings you make from the programme guide on the TV.

Press **🏠** and select **[Programme guide]**. If you find a TV Recording button on the programme guide page, you can access the programme guide to start and manage recordings.

If the TV Recording button is not present, check if the programme guide data is set to be updated through the network. Select **🏠** > **[Setup]** > **[TV settings]** > **[Preferences]** > **[Programme guide]** > **[From network]**.

### Record now

**To record the programme you are watching**, press **🏠** and select **[Programme guide]**. With the current TV programme highlighted, press **☰** **OPTIONS** and select **Record programme**. The USB hard disk starts recording and stops at the end of the programme.

**To stop recording immediately**, access the **[Programme guide]** and press **☰** **OPTIONS**, select **Stop recording**.

### Record a programme

You can schedule a recording of an upcoming programme for today or a few days from today (maximum of 8 days away).

- To schedule a recording, press **🏠** and select **[Programme guide]**.

At the programme guide page, select the channel and programme you wish to record. Press the right or left navigation buttons to shift the list. You can enter the channel number to select the channel in the list.

- To change the date, select the date at the top of the page and press **OK**. Select the date you want and press **OK**.

You can set the schedule to record all future episodes of a programme or set the schedule to add 10 minutes of buffer at the end of the recording. Highlight the programme, press **☰** **OPTIONS** and select **Record programme**.

Select **Schedule** and press **OK**. The programme is scheduled for recording.

A warning displays automatically when overlapping recordings are scheduled.

If you plan to record a programme during your absence, remember to switch the TV to standby and keep the USB hard disk switched on.

---

## Manage recordings

### List of recordings

To view the list of recordings and scheduled recordings, select the **Recordings** button above the programme guide list and press **OK**.

On this page with your recordings, you can:

- select a recording to watch,
- remove recorded programmes,
- check the free disk space, or
- schedule a timed recording not linked to a specific TV programme.

### Watch a recording

To watch a recording, select the arrow in front of the recording and press **OK**. The playback of the recording starts. You can use the **▶** (play), **▶▶** (forward), **◀◀** (rewind), **⏸** (pause) or **■** (stop) keys on the remote control to control play.

### Schedule a recording

Set a recording for a programme on a specific channel by entering its date and time without selecting a programme from the electronic programme guide.

Press **🏠** and select **[Programme guide]**.

Select **Schedule** and press **OK**. You need to set the channel, date and time span in the following pages.

### Remove a scheduled recording

To remove a scheduled recording, select the red circle in front of the recording and press **OK**.

### Delete a recording

To remove a recording, select the recording in the list and press **≡** **OPTIONS** and select **Delete recording**.

### Programme information

To view more information on a programme, select the programme in any programme guide list and press **OK**. Depending on the status of this programme, you can start watching it, schedule its recording, play back the recording, or delete the recording from this page.

---

## View Teletext

---

### Select a page

1. Select a channel that has teletext feature, then press **TEXT**.
2. Select a page in one of the following ways:
  - Enter the page number with the **Numeric buttons**.
  - Press **▲▼** or **◀▶** to view the next or previous page.
  - Press the **Colour buttons** to select a colour coded item.
3. Press **↩** to exit.

---

### Teletext options

1. When you view teletext, press **≡** **OPTIONS**.
2. Select one of the following options:
  - **[Freeze page] / [Unfreeze page]**: Freeze or unfreeze the current page.
  - **[Dual screen] / [Full screen]**: Enable or disable dual screen teletext. Dual screen splits the current channel or source to the left of the screen, with teletext on the right.
  - **[T.O.P. overview]**: Table Of Pages (T.O.P.) teletext broadcasts allow you to jump from one subject to another without using page numbers.
  - **[Enlarge] / [Normal view]**: Zoom in on the page. Press the **Navigation buttons** to move around the enlarged view.
  - **[Reveal]**: Hide or reveal hidden information on a page, such as solutions to riddles or puzzles.
  - **[Cycle subpages]**: If subpages are available, each is shown automatically.
  - **[Language]**: Switch to a different language group to display different character sets correctly.
3. Press **≡** **OPTIONS** to exit.

---

## Teletext language

Some digital TV broadcasters provide several teletext languages. You can set your primary and secondary language.

1. Press **▲**.
2. Select **[Setup]** > **[Channel settings]** or **[Satellite settings]**.
3. Select **[Languages]** > **[Primary Text]** or **[Secondary Text]**.
4. Select your preferred teletext languages, then press **OK**.

---

## Subpages

A teletext page can contain several subpages. These subpages are shown on a bar next to the main page number.

If subpages are available on a teletext page, press **◀** or **▶** to select them.

---

## Search

1. When you view teletext, press **OK** to highlight the first word or number.
2. Press the **Navigation buttons** to skip to the word or number to search.
3. Press **OK** to begin the search.
4. Press **▲** until no word or number is highlighted to exit the search.

---

## Digital teletext

Some digital TV broadcasters offer dedicated digital text or interactive services on their digital TV channels, for example, BBC1.

When in digital teletext:

- Press the **Navigation buttons** to select or highlight items.
- Press the **Colour buttons** to select an option, then press **OK** to confirm or activate.

**Note:** Digital text services are blocked when subtitles are broadcast and enabled on the TV. Read **Use more of your TV > View subtitles** (Page 30).

---

## Teletext 2.5

Teletext 2.5 offers more colours and better graphics than normal teletext. If Teletext 2.5 is broadcast by a channel, it is switched on by default.

### To switch Teletext 2.5 on or off

1. Press **▲**.
2. Select **[Setup]** > **[TV settings]** > **[Preferences]**.
3. Select **[Text 2.5]** > **[On]** or **[Off]**, then press **OK**.

---

## Set locks and timers

---

### Clock

You can display a clock on the TV screen. The clock displays the time that is broadcast by your TV service operator.

#### Display the TV clock

1. While you watch TV, press **≡** **OPTIONS**.
2. Select **[Status]**, then press **OK**.  
The clock is displayed on the lower right hand corner of the TV screen.

#### Change the clock mode

The clock mode is automatically synchronised to the Coordinated Universal Time (UTC). If your TV cannot receive UTC transmissions, change the clock mode to **[Manual]**.

1. While you watch TV, press **▲**.
2. Select **[Setup]** > **[TV settings]** > **[Preferences]**.
3. Select **[Clock]** > **[Auto clock mode]**.
4. Select **[Automatic]**, **[Manual]** or **[Country dependent]**, then press **OK**.

#### Enable or disable daylight saving

If clock mode is set to **[Country dependent]**, you can enable or disable daylight saving for your time zone.

1. In the **[Clock]** menu, select **[Daylight saving]** > **[Daylight saving time]** or **[Standard time]**, then press **OK**. Daylight saving is enabled or disabled.

---

## Set the clock manually

If clock mode is set to **[Manual]**, set the date and time manually.

1. In the **[Clock]** menu, select **[Date]** or **[Time]**, then press **OK**.
2. Use the **Navigation buttons** to make your selection.
3. Select **[Done]**, then press **OK**.

---

## Sleeptimer

Sleeptimer switches the TV to standby after a specified time. You can switch off your TV earlier or reset the sleeptimer during the countdown.

1. Press **🏠**.
2. Select **[Setup]** > **[TV settings]** > **[Preferences]** > **[Sleeptimer]**.
3. Press the **Navigation buttons** to set the sleeptimer.

The sleeptimer can be set up to 180 minutes, in steps of five minutes. The sleeptimer is switched off if it is set to zero minutes.

4. Press **OK** to activate the sleep timer. The TV switches to standby after the specified time.

---

## Child lock

To protect children from unsuitable TV programmes, you can lock the TV or block age rated programmes.

### Set or change the child lock code

1. Press **🏠**.
2. Select **[Setup]** > **[Channel settings]** > **[Child lock]**.
3. Select **[Set code]**, or **[Change code]**.
4. Enter the code with the **Numeric buttons**.

**Tip:** If you forget your code, enter '8888' to override any existing codes.

### Lock or unlock channels

1. In the child lock menu, select **[Channel lock]**.
2. Enter the child lock code with the **Numeric buttons**. The **[Channel lock]** menu appears.
3. Select channels to lock or unlock.

---

## Parental rating

Some digital broadcasters rate their programmes according to age. You can set your TV to display only programmes with age ratings lower than your child's age.

1. Press **🏠**.
2. Select **[Setup]** > **[Channel settings]** or **[Satellite settings]**.
3. Select **[Child lock]** > **[Parental rating]**.  
A message prompts you to enter the child lock code.

4. Enter the child lock code with the **Numeric buttons**.
5. Select an age rating, then press **OK**.

All programmes above the selected age rating are blocked.

For information on child lock codes, see **Use more of your TV > Set locks and timers > Child lock** (Page 30).

---

## View subtitles

---

### Analogue channels

1. Switch the TV to an analogue TV channel.
2. Press **TEXT**.
3. Enter the three-digit page number of the subtitles page (usually '888').
4. Press **↩** to exit teletext.  
Subtitles display if available.

---

### Digital channels

1. Press **☰ OPTIONS**.
2. Select **[Subtitles]**, then press **OK**.
3. Select **[Subtitles off]**, **[Subtitles on]** or **[On during mute]**, then press **OK**.

#### Note:

- If MHEG application is activated, subtitles are not displayed.
- If you select **[On during mute]**, subtitles are displayed only when you press **🔇** to mute the sound.

---

## Subtitle language

You can change the subtitle language on some digital channels.

1. Press **▲**.
2. Select **[Setup]** > **[Channel settings]** or **[Satellite settings]** > **[Subtitle language]**.
3. Select **[Primary subtitles]** or **[Secondary subtitles]** for the preferred language.
4. Press **OK** to confirm.

**Tip:** You can also press **☰ OPTIONS** > **[Subtitle language]**.

---

## View Scenea

### What you can do

You can display a default picture as the wallpaper on your TV. You can also load another picture as the wallpaper.

If the sleeptimer is off, the wallpaper is displayed for 240 minutes. Otherwise, it is displayed for the duration of the sleeptimer.

### What you need

To use another picture as the wallpaper, you need a USB storage device that contains a picture that is less than 1 MB in size.

### Switch on

1. Press **▲**.
2. Select **[Scenea]**, then press **OK**.

The default picture is displayed.

**Note:** The wallpaper is displayed for the duration of the sleeptimer. For more information on sleeptimer, see **Use more of your TV > Set locks and timers > Sleeptimer** (Page 30).

---

### Set TV wallpaper

You can load another picture as the wallpaper.

**Note:** Loading a new picture overrides the existing picture.

1. Connect the USB storage device to the TV.
2. Press **▲**.
3. Select **[Browse USB]**, then press **OK**.
4. Select a picture, then press **☰ OPTIONS**.
5. Select **[Set as Scenea]**, then press **OK**.
6. Select **[Yes]**, then press **OK**.
7. Press any button to exit Scenea.

---

### Set Scenea lounge light

When the TV is in standby, you can switch on Ambilight and create a lounge light effect with your wallpaper. Ambilight is available on certain models only.

When the TV is in standby, press **AMBILIGHT** on the front of the TV.

**Note:** It can take more than 5 seconds for the lounge light to switch on.

To select another colour for the lounge light, see **Use your TV > Ambilight > Setup** (Page 19).

---

## Set universal access

### Switch on

Some digital TV broadcasters provide special audio and subtitle features for people who are hearing or visually impaired.

To enable these features, turn on universal access in the preference menu.

1. Press **▲**.
2. Select **[Setup]** > **[TV settings]** > **[Preferences]**.
3. Select **[Universal access]** > **[On]**, then press **OK**.

---

### Hearing impaired

**Tip:** To verify whether a hearing impaired audio language is available, press **☰ OPTIONS** and select **[Audio language]**. Languages with an ear icon support hearing impaired audio.

## To switch on hearing impaired audio and subtitles

1. While you watch TV, press **⋮** **OPTIONS**.
2. Press one of the following buttons to select an option:
  - **Red**: Switch hearing impaired on or off.
  - **Green**: Switch on hearing impaired audio and subtitles.
3. Press **↩** to exit.

---

## Visually impaired

**Tip:** To verify whether visually impaired audio is available, press **⋮** **OPTIONS** and select **[Audio language]**. Languages with an eye icon support visually impaired audio.

### To switch on visually impaired audio (if available)

1. While you watch TV, press **⋮** **OPTIONS**.
2. Press the green button to select **[Visually impaired]**.
3. Press one of the following buttons to select an option:
  - **Red - [Off]**: Turn off visually impaired audio.
  - **Yellow - [Headphones]**: Hear visually impaired audio from headphones only. (if applicable)
  - **Green - [Speakers]**: Hear visually impaired audio from speakers only.
  - **Blue - [Speakers + headphones]**: Hear visually impaired audio from speakers and headphones.
4. Press **↩** to exit.

**Note:** If the EasyLink remote control is enabled, you cannot select the green or yellow buttons. To disable, see **Use more of your TV > Use EasyLink > Switch on**. (Page 33)

### Adjust volume for the visually impaired

1. In the **[Universal access]** menu, press the yellow button to select **[Mixed volume]**.
2. Press the **Navigation buttons** to move the slider up or down, then press **OK**.
3. Press **↩** to exit.

## Audio feedback for the visually impaired

This feature enables audio feedback when buttons are pressed on the remote control or TV.

1. In the **[Universal access]** menu, press the blue button to select **[Key beep]**.
2. Press the green button to turn on audio feedback, or press the red button to turn it off.
3. Press **↩** to exit.

---

## Use EasyLink

### What you can do

Get the most out of your HDMI-CEC compliant devices with Philips EasyLink enhanced control features. If your HDMI-CEC compliant devices are connected through HDMI, you can control them at the same time with your TV remote control .

**Note:** Other brands describe HDMI-CEC functionality differently. Some examples are Anynet (Samsung), Aquos Link (Sharp) or BRAVIA Sync (Sony). Not all brands are fully compatible with Philips EasyLink.

After you switch on Philips EasyLink, these features are available:

#### One-touch play

When you play an HDMI-CEC compliant device, the TV switches on from standby, and switches to the correct source.

#### One-touch standby

When you press **⏻** on the TV remote control, the TV and all HDMI-CEC compliant devices switch to standby mode.

#### System audio control

If you connect an HDMI-CEC compliant device that includes speakers, you can choose to hear the TV from those speakers instead of the TV speakers.

For more information about TV audio output, see **Use more of your TV > Use EasyLink > Select speaker output** (Page 34).



## EasyLink remote control

You can control multiple HDMI-CEC compliant devices with your TV remote control.

To switch on EasyLink Remote Control, see **Use more of your TV > Use EasyLink > Control devices simultaneously** (Page 33).

### Retain picture quality

If your TV picture quality is affected by the picture-processing features of other devices, switch on Pixel Plus Link.

To switch on Pixel Plus Link, see **Use more of your TV > Use EasyLink > Retain picture quality** (Page 34).

### Maximize display for subtitled video

While you view subtitles in a video, you can maximize the video display area. Some subtitles can create a separate subtitle bar under the video, which limits the video display area. After you switch on auto subtitle shift, the subtitles display on top of the video image, which maximizes the video display area.

To switch on auto subtitle shift, see **Use more of your TV > Use EasyLink > Maximize display for video with subtitles** (Page 34).

### Hear another device at standby

You can hear a connected HDMI-CEC compliant device through the TV speakers, even when the TV is in standby.

To switch on, see **Use more of your TV > Use EasyLink > Hear another device at TV standby** (Page 35).

---

## What you need

To benefit from Philips EasyLink advanced control features, make sure that you do the following:

- Connect at least two HDMI-CEC compliant devices through HDMI
- Configure each HDMI-CEC compliant device properly
- Switch on EasyLink

---

## Switch on

### To switch on or off EasyLink

**Note:** If you do not intend to use Philips Easylink, switch it off.

1. Press **⬆**.
2. Select **[Setup] > [TV settings] > [EasyLink]**.
3. Select **[On]** or **[Off]**, then press **OK**.

---

## Control devices simultaneously

If you connect multiple HDMI-CEC devices that support this setting, all the devices respond to the TV remote control.

**Caution:** This is an advanced setting. Devices that do not support this setting will not respond to the TV remote control.

1. Press **⬆**.
2. Select **[Setup] > [TV settings] > [EasyLink]**.
3. Select **[EasyLink Remote Control] > [On]** or **[Off]**.
4. Press **OK** to activate.

### • Notes:

- To switch back to TV control, press **⬆**, then select **[Watch TV]**.
- To control another device, press **⬆**, then select the device from the Home menu.
- To exit, press **⬅**.

### EasyLink buttons

Control HDMI-CEC compliant devices with the following buttons on the TV remote control.

- **OK:** Start, pause or resume play on the connected device, activate a selection, or access the device menu.
- **⏮ (Previous) / ⏭ (Next):** Search backwards and forwards on the connected device.
- **Numeric buttons:** Select a title, chapter or track.
- **Play buttons:** Control video or music play.
- **Standby:** Display the menu of the connected device.

- **🏠**: Display the TV menu.
- **⏻ (Standby)**: Switch the TV and the connected device to standby.

Other EasyLink buttons are available through the On-Screen Remote Control (OSRC).

### To access the OSRC

1. While you view content from a connected device, press **☰ OPTIONS**.
2. Select **[Show device keys]**, then press **OK**.
3. Select an onscreen button, then press **OK**.
4. Press **⏻** to exit.

---

## Select speaker output

If the connected device is HDMI Audio Return Channel (HDMI ARC) compliant, you can output TV audio through an HDMI cable. An additional audio cable is not required. See **Connect your TV > About cables > HDMI (Page 43)**.

### Configure TV speakers

1. Press **🏠**.
2. Select **[Setup] > [TV settings] > [EasyLink] > [TV speakers]**.
3. Select one of the following options, then press **OK**:
  - **[Off]**: Switch off TV speakers.
  - **[On]**: Switch on TV speakers.
  - **[EasyLink]**: Stream TV audio through the connected HDMI-CEC device. Switch the TV audio to the connected HDMI-CEC audio device through the adjust menu.
  - **[EasyLink autostart]**: Turn off TV speakers automatically and stream TV audio to the connected HDMI-CEC audio device.

### Select speaker output with Adjust menu

If **[EasyLink]** or **[EasyLink autostart]** are selected, access the adjust menu to switch the TV audio.

1. While you watch TV, press **≡ ADJUST**.
2. Select **[Speakers]**, then press **OK**.
3. Select one of the following, then press **OK**:

- **[TV]**: On by default. Stream TV audio through the TV and the connected HDMI-CEC audio device until the connected device switches to system audio control. TV audio is then streamed through the connected device.
- **[Amplifier]**: Stream audio through the connected HDMI-CEC device. If system audio mode is not enabled on the device, audio continues to stream from the TV speakers. If **[EasyLink autostart]** was enabled, the TV prompts the connected device to switch to system audio mode.

---

## Retain picture quality

If your TV picture quality is affected by the picture-processing features of other devices, switch on Pixel Plus Link.

### To switch on Pixel Plus Link

1. Press **🏠**.
2. Select **[Setup] > [TV settings] > [EasyLink]**.
3. Select **[Pixel Plus link] > [On]**, then press **OK**.

---

## Maximize video display

Some subtitles can create a separate subtitle bar under the video, which limits the video display area. After you switch on auto subtitle shift, the subtitles display over the video image, which maximizes the video display area.

### Switch on auto subtitle shift

1. Press **🏠**.
2. Select **[Setup] > [TV settings] > [EasyLink] > [Auto subtitle shift]**.
3. Select **[On]**, then press **OK** to activate.

Note: Make sure that the picture format of the TV is set to **[Auto format]** or **[Movie expand 16:9]**.

---

## Hear another device at TV standby

You can hear a connected HDMI-CEC compliant device through the TV speakers, even when the TV is in standby.

1. Press **III ADJUST** to receive audio from the connected Philips EasyLink device. If available, audio only mode is enabled.
2. Accept the prompt on the TV to turn off the TV screen.
3. Control the audio playback with the TV remote control.

# 4 Set up your TV

---

## Settings assistant

Use the settings assistant to guide you through the picture and sound settings.

1. While you watch TV, press **⏠**.
2. Select **[Setup]** > **[Quick picture and sound settings]**, then press **OK**.
3. Select **[Start]**, then press **OK**.
4. Follow the onscreen instructions to choose your preferred settings.

---

## Picture and sound

### More picture settings

1. Press **⏠**.
2. Select **[Setup]** > **[TV settings]** > **[Picture]**, then press **OK**.
3. Select a setting to adjust:
  - **[Smart picture]**: Access predefined smart picture settings.
  - **[Reset]**: Reset to default settings.
  - **[Contrast]**: Adjust the intensity of the bright areas, keeping dark areas unchanged.
  - **[Brightness]**: Adjust the intensity and details of the dark areas.
  - **[Colour]**: Adjust colour saturation.
  - **[Hue]**: Compensate colour variations in NTSC encoded transmissions.
  - **[Sharpness]**: Adjust sharpness in the image.
  - **[Noise reduction]**: Filter and reduce noise in the image.
  - **[Tint]**: Adjust the colour balance in the image.
  - **[Custom tint]**: Customise tint setting.

- **[Pixel Plus HD]/ [Pixel Precise HD]**: Access advanced settings, including **[HD Natural Motion]**, **\*[Perfect Natural Motion]**, **[100 Hz Clear LCD]**, **[Super resolution]**, **[Dynamic contrast]**, **[Dynamic backlight]**, **[MPEG artefact reduction]**, **[Colour enhancement]**, **[Gamma]**.  
\*Available on certain models only.
- **[PC mode]**: Allow picture settings to be changed when a PC is connected to the TV through HDMI. If enabled, you can select **[Picture format]** > **[Unscaled]** which provides maximum detail for display of PC content.
- **[Light sensor]**: Adjust settings dynamically to match lighting conditions.
- **[Picture format]**: Change the picture format.
- **[Screen edges]**: Change the picture size.
- **[Picture shift]**: Adjust the position of the picture. You cannot select this setting if the selected picture format is **Auto zoom** or **Wide screen**.

---

### More sound settings

1. Press **⏠**.
2. Select **[Setup]** > **[TV settings]** > **[Sound]**, then press **OK**.
3. Select a setting to adjust:
  - **[Smart sound]**: Access predefined smart sound settings.
  - **[Reset]**: Reset to factory default settings.
  - **[Bass]**: Adjust the bass level.
  - **[Treble]**: Adjust the treble level.
  - **[Surround]**: Enable spatial sound.
  - **[Headphones volume]**: Adjust headphone volume.
  - **[Auto volume leveling]**: Automatically reduce sudden volume changes, for example when switching channels.
  - **[Balance]**: Adjust the balance of the left and right speakers.

## Audio settings

### Select audio language

If the TV channel has multiple or dual sound broadcast, you can select the preferred audio language.

While you watch TV, press **≡** **OPTIONS**.

- **[Audio language]**: Select the audio language for digital channels.
- **[Dual I-II]**: Select the audio language for analogue channels.

Digital TV channels can stream several audio languages. If multiple languages are available, select the preferred language.

1. Press **⬆**.
2. Select **[Setup]** > **[Channel settings]** or **[Satellite settings]** > **[Language]**.
3. Select one of the following settings, then press **OK**:
  - **[Primary audio]** / **[Secondary audio]**: Select the available audio language. Set a secondary language in the same menu. If the primary language is unavailable, the TV receives this language.
  - **[Preferred audio format]**: Select to receive standard audio format (MPEG) or advanced audio formats (AAC, EAC-3 or AC-3 if available).
  - **[Mono/Stereo]**: Select mono or stereo audio if stereo broadcasting is available.
4. Press **↩** to exit.

### Reset to factory settings

You can restore default picture and sound settings, while the channel installation settings remain the same.

1. While you watch TV, press **⬆**.
2. Select **[Setup]** > **[TV settings]** > **[Factory settings]**, then press **OK**.  
TV settings are reset to default.

## Channels

### Reorder and rename

#### Reorder channels

After the channels are installed, you can reorder the channel list to your preference.

1. While you watch TV, press **Q** **FIND**. The channel list is displayed.
2. Select the channel to reorder and press **≡** **OPTIONS**.
3. Select **[Reorder]**, then press **OK**.
4. Press the **Navigation buttons** to move the highlighted channel to another location, then press **OK**.
5. Select one of the following options, then press **OK**.
  - **[Insert]**: Insert the channel into the desired location.
  - **[Swap]**: Swap location with another channel.
6. Once complete, press **≡** **OPTIONS** and select **[Exit]**.

#### Rename channels

After the channels are installed, you can rename them to your preference.

1. While you watch TV, press **Q** **FIND**. The channel list is displayed.
2. Select the channel to rename and press **≡** **OPTIONS**.
3. Select **[Rename]**, then press **OK**.
4. In the entry screen, press the **Navigation buttons** or **Numeric buttons** to edit the name, then press **OK**.

**Tip:** You can press **OK** in the entry screen to enable the **Onscreen Keyboard**.

5. Once complete, press the **Navigation buttons** to select **[Done]**.
  - To clear the entry, select **[Clear]**.
  - To cancel, select **[Cancel]**.
6. Press **OK** to confirm.
7. Press **↩** to exit.

---

## Hide or unhide

### Hide channels

To prevent unauthorised access to channels, hide them from the channel list.

1. While you watch TV, press **Q FIND**.
2. Select the channel to rename and press **☰ OPTIONS**.
3. Select **[Hide channel]**, then press **OK**.  
The channel is hidden.

### Unhide channels

1. While you watch TV, press **Q FIND**.
2. Press **☰ OPTIONS**.
3. Select **[Show hidden channels]**, then press **OK**.  
Hidden channels appear in the channel list, but the channel information is not displayed.
4. Select a radio channel, then press **☰ OPTIONS**.
5. Select **[Unhide all]**, then press **OK**. All hidden channels are displayed.

---

## Update channel list

When the TV was switched on for the first time, a full installation of channels was performed.

You can automatically add or remove digital channels or manually update channels.

**Note:** If you are prompted to enter a code, enter '8888'.

### Automatic update

To automatically add or remove digital channels, leave the TV in standby mode. The TV updates channels and stores new channels everyday. Empty channels are removed from the channel list.

If a channel update is performed, a message appears at startup.

**If you do not want this message to appear**

1. Press **🏠**.
2. Select **[Setup] > [Channel settings]** or **[Satellite settings]**.
3. Select **[Channel installation] > [Channel update message]**.
4. Select **[Off]**, then press **OK**.

### To disable automatic updates

In the **[Channel installation]** menu, select **[Automatic channel update] > [Off]**.

---

## Automatic install

When the TV was switched on for the first time, a full installation of channels was performed. You can run this full installation again to set your language, country and install all available TV channels.

### Select network

To install cable or antenna channels, you need to switch to the respective network.

1. While you watch TV, press **🏠**.
2. Select **[Setup] > [Channel settings]**.
3. Select **[Channel installation] > [Antenna or Cable DVB]**.
4. Select one of the following settings:
  - **[Antenna (DVB-T)]**: Access free-to-air antenna or digital DVB-T channels.
  - **[Cable]**: Access cable or digital DVB-C channels.
5. Press **OK** to confirm.
6. Press **↩** to exit.

### Start installation

1. Press **🏠**.
2. Select **[Setup] > [Search for channels]**, then press **OK**.
3. Follow the onscreen instructions to complete the channel installation.
4. Once complete, select **[Finish]**, then press **OK**.

**Tip:** Press **Q FIND** to see the channel list.

### Notes:

- During installation, leave settings unchanged unless your digital provider gives you the specific values to enter.
- When digital TV channels are found, the list of installed channels may display empty channel numbers. You can rename, reorder or uninstall these channels.

---

## Install analogue channels

You can search and store analogue TV channels manually.

### Step 1: Select your system

**Note:** Skip this step if your system settings are correct.

1. While you watch TV, press **⬆**.
2. Select **[Setup]** > **[Channel settings]** > **[Channel installation]**.
3. Select **[Analogue: Manual installation]** > **[System]**, then press **OK**.
4. Select the system for your country or region, then press **OK**.

### Step 2: Search and store new TV channels

1. In the **[Analogue: Manual installation]** menu, select **[Find channel]**, then press **OK**.
2. Select one of the following options:
  - Press the **Navigation buttons** or **Numeric buttons** to manually enter the channel frequency.
  - Select **[Search]** then press **OK** to search for the next channel automatically.
3. When the correct channel frequency is entered, select **[Done]**, then press **OK**.
4. Select **[Store as new channel]**, then press **OK** to store the new TV channel.

---

## Install digital and satellite channels

### Install digital channels

To improve TV reception, reposition the antenna. You need to know the correct frequency to tune. For best results, contact the service provider or get a professional installer.

1. Press **⬆**.
2. Select **[Setup]** > **[Channel settings]** > **[Channel installation]**.
3. Select **[Digital: Reception test]** > **[Search]**, then press **OK**.
4. Press the **Numeric buttons** to enter the channel frequency.
5. Select **[Search]**, then press **OK**.
6. When the correct channel is located, select **[Store]**, then press **OK**.
7. Press **⏪** to exit.

### Notes

- If the reception is poor, reposition your antenna and repeat the procedure.
- If you receive the channel with DVB-C, select **[Automatic]** in **[Symbol rate mode]** unless your cable provider supplies you with a specific symbol rate value.

### Install satellite channels

**Note:** Available on certain models only. **[Search for satellite]** is only available if the TV supports DVB-S.

If your satellite receiver is connected to the SAT connector, you can receive satellite channels.

1. While you watch TV, press **⬆**.
2. Select **[Setup]** > **[Search for satellite]** > **[Reinstall channels]**.
3. Follow the onscreen instructions to complete the installation.
4. Once complete, select **[Finish]**, and then press **OK**.

### View satellite channels

To watch satellite channels, press **⬆** > **[Watch satellite]**.

---

## Fine-tune channels

If the reception of an analogue TV channel is poor, fine-tune the TV channel.

1. Press **⬆**.
2. Select **[Setup]** > **[Channel settings]** > **[Channel installation]**.
3. Select **[Analogue: Manual installation]** > **[Fine tune]**, and then press **OK**.
4. Press **▲** or **▼** to fine-tune the channel.
5. When you have selected the correct channel frequency, select **[Done]**, and then press **OK**.
6. Select one of the following options, then press **OK**.
  - **[Store current channel]:** Store the channel as the current channel number.
  - **[Store as new channel]:** Store the channel as a new channel number.

---

## Reinstall channels

**ATTENTION:** This feature is intended for dealers and service personnel.

You can copy channel lists from one Philips TV to another through a USB storage device. You do not need to search for channels or install them again on the second TV. The channel list file is small enough to fit on any USB storage device.

### What you need

The two Philips TVs must have:

- the same country setting,
- the same year range,
- the same DVB type, as indicated by the suffix (H, K, T, or D/00) in the model name,
- the same settings for satellite channels, including the number of LNB satellites
- the same hardware type, as indicated by the sticker on the back of the TV, (for example Qxxx.xx.Lx), and
- compatible software versions.

An onscreen message will notify you if the channel list cannot be copied to the second TV.

**Note:** If you are prompted to enter a code, enter '8888'.

### Copy channel list to USB

1. Connect a USB storage device to the TV with the channels installed on it.
2. Press **⏠**.
3. Select **[Setup] > [TV settings] > [Preferences] > [Channel list copy] > [Copy to USB]**, then press **OK**. The channel list is copied to the USB storage device.
4. Unplug the USB storage device.

### Copy channel list to TV with no channels installed

1. Switch on the TV with no channels installed on it to start the initial installation. Select the language and country. The country setting must be the same as that of the TV whose channel list you want to copy. Skip the search for channels.

2. Connect the USB storage device containing the channel list to the TV.
3. Press **⏠**.
4. Select **[Setup] > [TV settings] > [Preferences] > [Channel list copy] > [Copy to TV]**, then press **OK**. The channel list is copied to the TV.
5. Unplug the USB storage device.

### Copy channel list to TV with no channels installed

1. Switch on the TV on which you want to copy the channel list.
2. Press **⏠**.
3. Select **[Setup] > [Search for channels] > [Reinstall channels]**, then press **OK**.

You will be prompted to select the country where the TV was installed. Make a note of the current setting and press **↩** followed by **[Cancel]** to exit.

4. If the country setting on the TV is different from that of the TV whose channel list you want to copy, reinstall the TV and select the country setting to match the first TV. See **Set up your TV > Reinstall the TV** (Page 42).
5. Connect the USB storage device containing the channel list to the TV where you want to copy the channel list.
6. Select **[Setup] > [TV settings] > [Preferences] > [Channel list copy] > [Copy to TV]**, then press **OK**. The channel list is copied to the TV storage device.
7. Unplug the USB storage device.

---

## Menu language

1. While you watch TV, press **⏠**.
2. Select **[Setup] > [TV settings] > [Preferences] > [Menu language]**.
3. Select a menu language from the list, then press **OK**.

---

## Other settings

### TV demo

Start a demo to find out more about your TV's features.



**Note:** Demos are not supported on MHEG channels.

1. While you watch TV, press **⏠**.
2. Select **[Setup]** > **[Watch demos]**, then press **OK**.
3. Select a demo, then press **OK**.
4. Press **↩** to exit.

---

## Update software

---

### TV software

#### Check software version

1. Press **⏠**.
2. Select **[Setup]** > **[Software settings]** > **[Current software info]**, then press **OK**.

The version of the current software is displayed.

**Caution:** Do not install a lower version of software than the current version installed on your product. Philips cannot be held liable or be made responsible for problems caused by a software downgrade.

Update the software through one of these options:

- update with USB flash drive
- update from digital broadcast
- update from the Internet

For more information, see the following pages.

#### Update with USB

Before performing this procedure, make sure that you have the following:

- Spare time to complete the entire update.
- A USB flash drive that has at least 256MB of storage space, is FAT or DOS formatted, and has its write protection disabled.
- Access to a computer with a USB port and internet access.

**Note:** Do not use a USB hard drive.

1. Press **⏠**.
2. Select **[Setup]** > **[Update software]**, then press **OK**.  
The update assistant starts.
3. Follow the onscreen instructions to start the update.

**Note:** The update assistant directs you to the Philips support website. Refer to the installation instructions on the website to complete the update.

#### Update from the Internet

To update the TV software directly from the Internet, connect the TV to the Internet through a router with a high-speed connection.

1. Press **⏠** > **[Setup]** > **[Update now]**, then press **OK**.
2. Select **[Internet]**, then press **OK**.
3. Follow the onscreen instructions to start the update.

When the update is complete, the TV switches off and back on again automatically. Wait for the TV to switch back on. Do not use the power switch on the TV or the remote control.

**Note:** If the TV is connected to the Internet, the TV displays the availability of new software at startup.

#### Update from digital broadcast

When available, your TV can receive software updates through digital broadcasts. A message appears prompting you to update the software. We strongly recommend that you update the software when prompted.

Follow the instructions on screen.

**Note:** If you choose to update the software at a later time, select > **[Setup]** > **[Software settings]** > **[Local updates]**.

---

## Onscreen Help

### What you need

Before you update the onscreen **[Help]**, make sure that you have the following:

- A USB storage device that is FAT or DOS-formatted.
- A PC with Internet access.

- An archive utility that supports the ZIP file format (for example, WinZip for Microsoft Windows or Stuffit for Macintosh).

Note: Do not use a USB hard drive.

### Download the latest file

1. Insert a USB storage device into the USB connector on your PC.
2. Create a folder named 'upgrades' in the root directory of the USB storage device.
3. In your web browser, navigate to [www.philips.com/support](http://www.philips.com/support).
4. At the Philips Support site, find your product and locate the **[Help]** file for your TV. The file (a \*.upg file) is compressed into a \*.zip archive.
5. If the **[Help]** file is a later version than the file in your TV, click it.
6. Save it to your PC.
7. Using an archive utility, extract the \*.upg file from the \*.zip file.
8. Save the \*.upg file to the 'upgrades' folder in the USB storage device.
9. Disconnect the USB storage device from the PC.

### Update **[Help]**

- Do not switch off the TV or remove the USB storage device during the update.
  - If a power failure occurs during the update, do not remove the USB storage device from the TV. The TV continues to update as soon as power is restored.
  - If an error occurs during the update, retry the procedure. If the error reoccurs, contact Philips Consumer Care.
1. Switch on the TV.
  2. Disconnect all other USB devices from the TV.
  3. Connect the USB storage device containing the \*.upg file to the USB connector on the TV.
  4. Press **⏠**.

5. Select **[Setup]** > **[Software settings]** > **[Local updates]**.

The updates screen appears.

6. Select the '\*.upg' file and press **OK**.

A message displays the update status.

7. Follow the onscreen instructions to complete the update and restart your TV.

---

## Reinstall the TV

Reinstall your TV to reset all picture and sound settings and reinstall all TV channels.

1. Press **⏠**.
2. Select **[Setup]** > **[TV settings]** > **[Reinstall TV]**, then press **OK**.
3. Follow the onscreen instructions.

# 5 Connect your TV

## About cables

### Cable quality

#### Overview

Before you connect devices to the TV, check the available connectors on the device. Connect the device to the TV with the highest quality connection available. Good quality cables ensure a good transfer of picture and sound.

The connections shown in this user manual are recommendations only. Other solutions are possible.

**Tip:** If your device only has composite or RCA connectors, use a SCART-cinch adapter to connect the device to a SCART connector on the TV.

### HDMI

An HDMI connection has the best picture and sound quality.

- An HDMI cable combines video and audio signals. Use HDMI for high-definition (HD) TV signals, and to enable EasyLink.
- An HDMI Audio Return Channel (ARC) connector allows output of TV audio to an HDMI ARC compliant device.

- Do not use an HDMI cable longer than 5 meters / 16.4 feet.

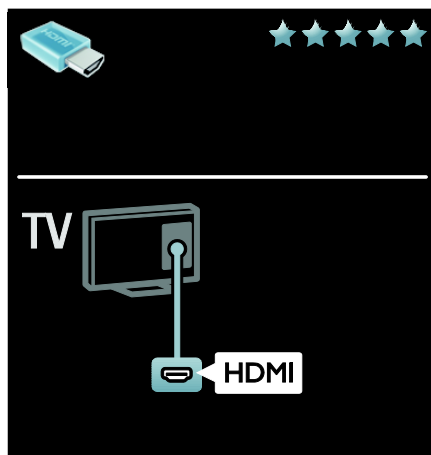

### Y Pb Pr

Use the Component Video (Y Pb Pr) connection together with an Audio Left and Right connection for sound.

Y Pb Pr can handle high-definition (HD) TV signals.

Match the Y Pb Pr connector colours to the cable plugs.

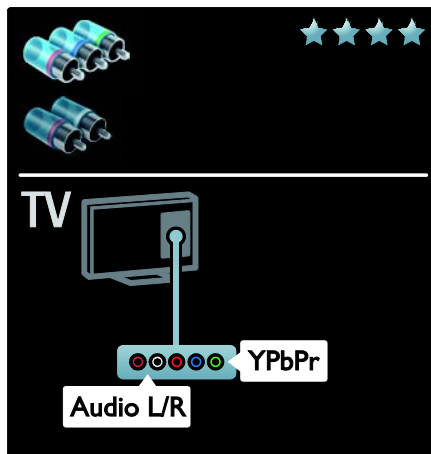

---

## SCART

A SCART cable combines video and audio signals.  
SCART connectors can handle RGB video signals but cannot handle high-definition (HD) TV signals.

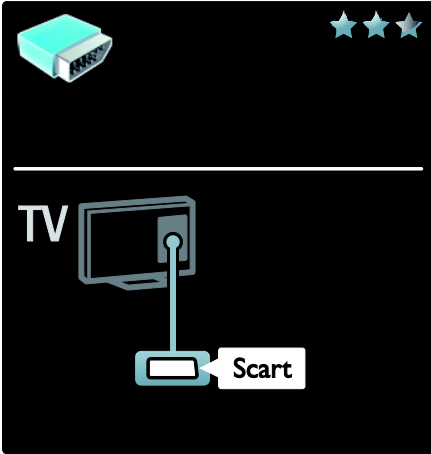

---

## VGA

Use this connection to display PC content on the TV.  
For video and sound, use the VGA and AUDIO IN connectors.

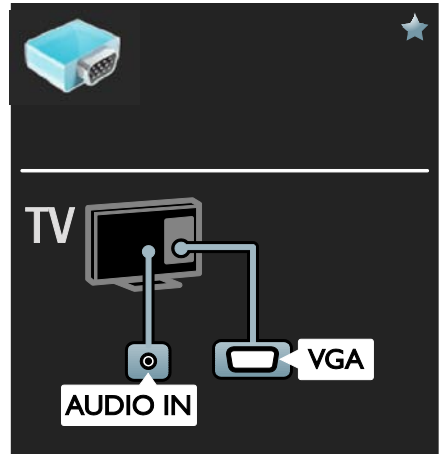

---

## Connect devices

---

### Overview

You can connect your devices to the TV with any of the following options. After connection, press **Home** > [Add your devices].

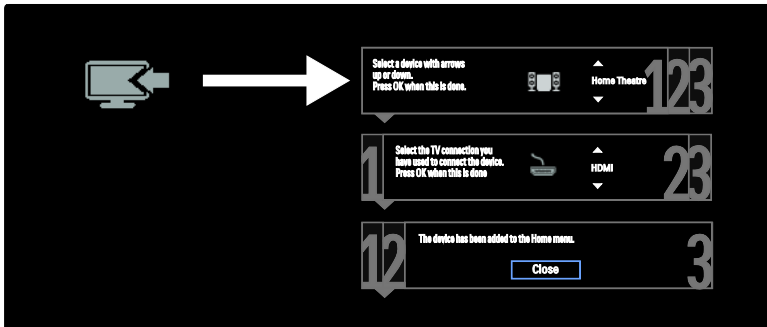

## Blu-ray or DVD disc player

Connect the disc player with an HDMI cable to the TV.

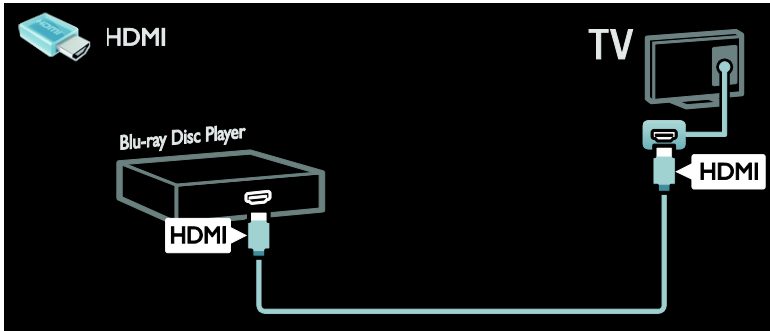

Connect the disc player with a component cable (Y Pb Pr) and an audio L/R cable to the TV.

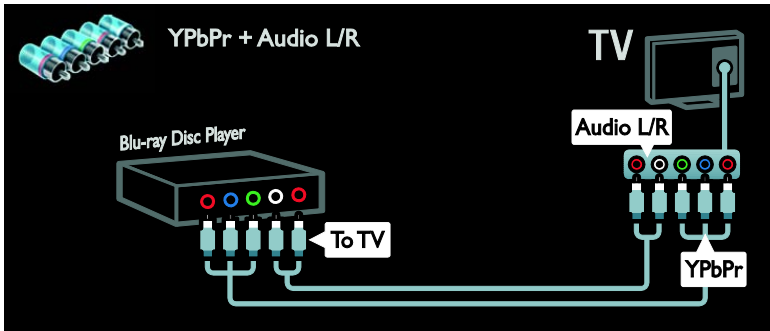

## TV receiver

Connect the satellite or digital TV receiver with an antenna cable to the TV. (SAT is available on certain models only.)

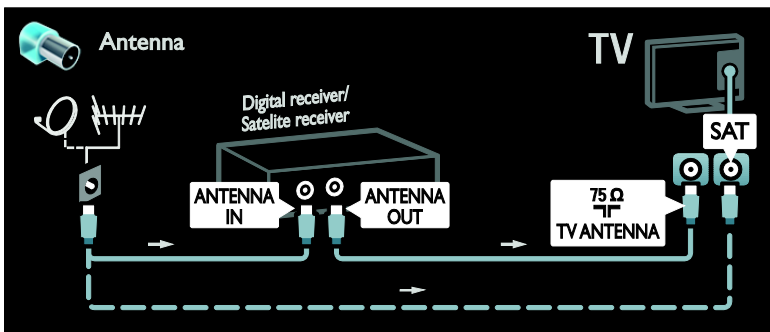

Connect the satellite or digital TV receiver with an HDMI cable to the TV.

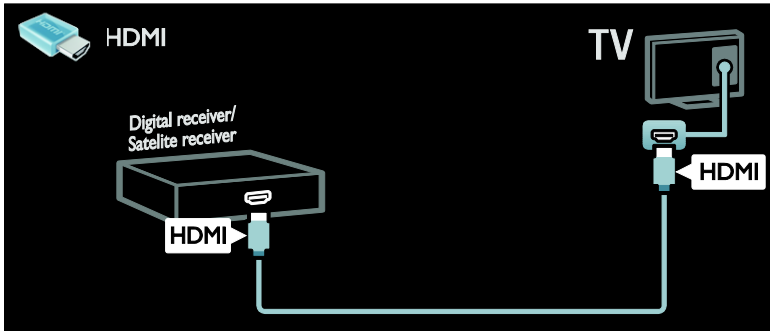

Connect the satellite or digital TV receiver with a SCART cable to the TV.

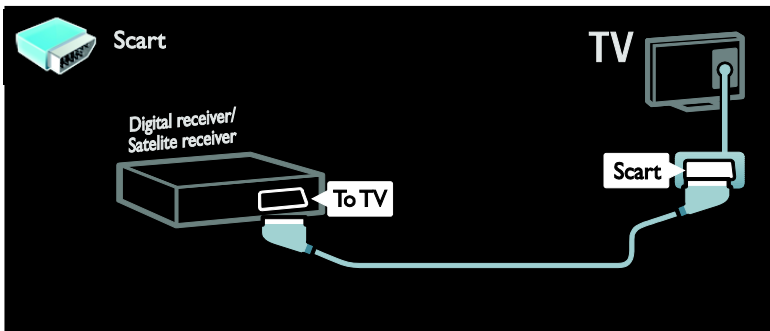

Connect the satellite or digital TV receiver with a component cable (Y Pb Pr) and an audio L/R cable to the TV.

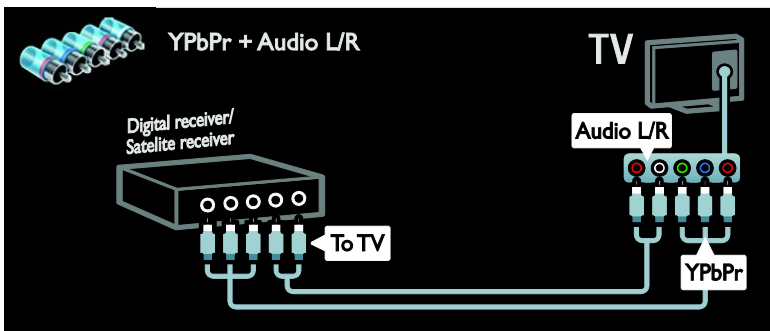

## Recorder

Connect the recorder with an antenna cable to the TV. (SAT is available on certain models only.)

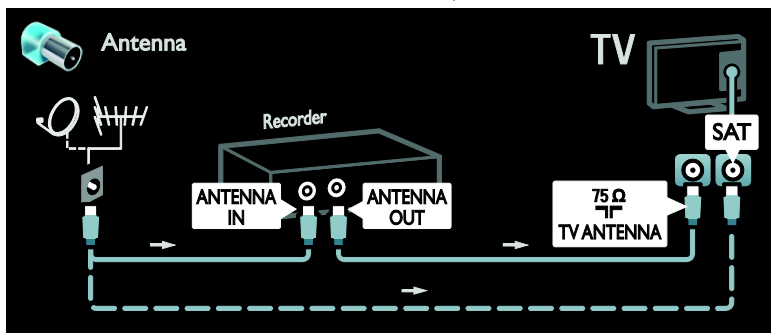

Connect the recorder with a SCART cable to the TV.

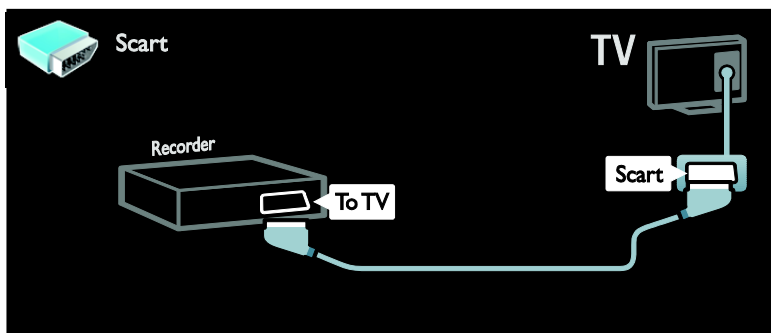

Connect the recorder with a component cable (Y Pb Pr) and an audio L/R cable to the TV.

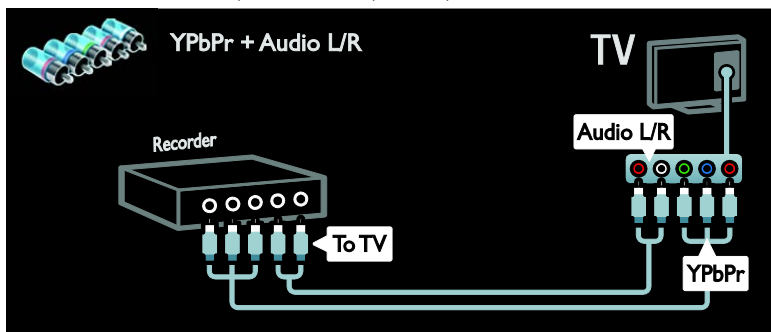

## Game console

The most practical connectors for a game console are on the side of the TV. However, you can also use the connectors at the back of the TV.

For the best gaming experience, set the TV to game mode.

1. Press **III** **ADJUST**.
2. Select **[Smart picture] > [Game]**, then press **OK**.
3. To exit, press **↶**.

Connect the game console with an HDMI cable to the TV.

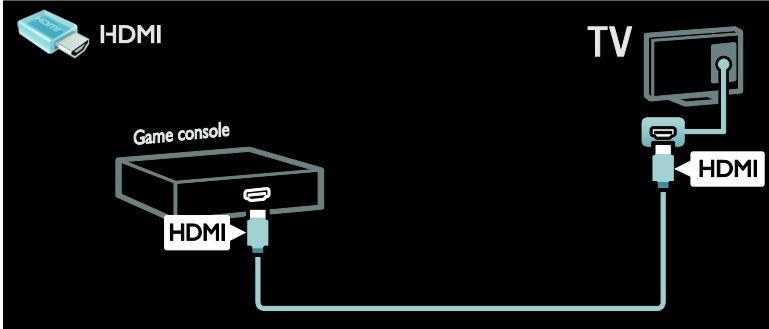

Connect the game console with a component cable (Y Pb Pr) and an audio L/R cable to the TV.

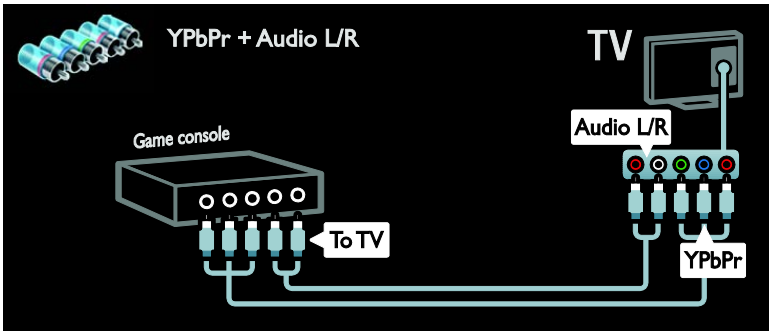

---

## Home theatre system

Connect the home theatre with an HDMI cable and an optical or coaxial audio cable to the TV.  
(Optical audio output is available on certain models only.)

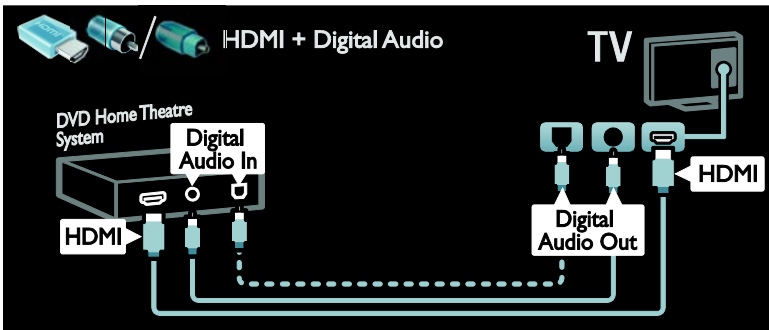



Connect the home theatre with a SCART cable to the TV.

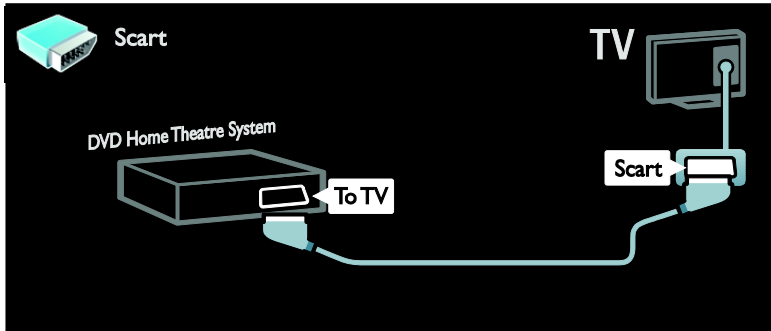

Connect the home theatre with a component cable (Y Pb Pr) and an audio L/R cable to the TV.

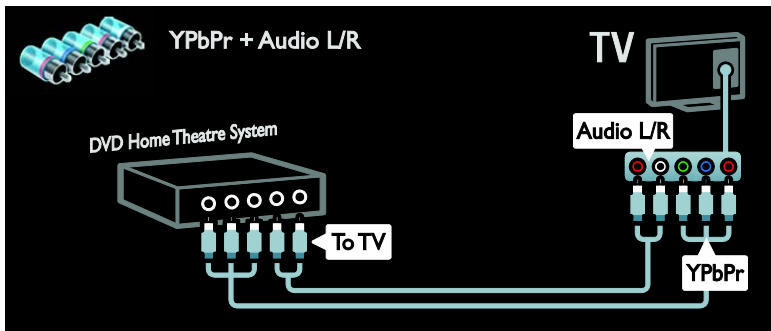

## Digital camera

Connect the digital camera with a USB cable to the TV.

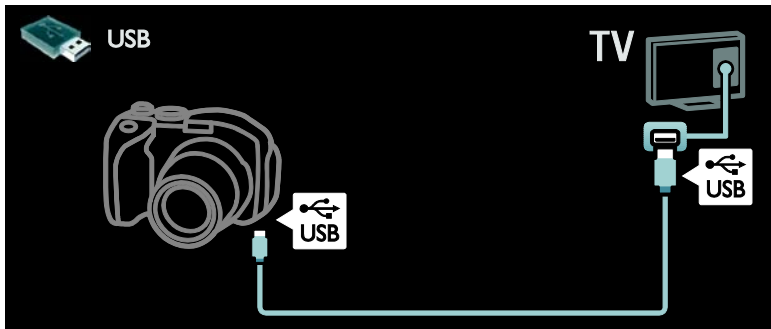

---

## Digital camcorder

Connect the digital camera with an HDMI cable to the TV.



Connect the digital camcorder with a component cable (Y Pb Pr) and an audio L/R cable to the TV.

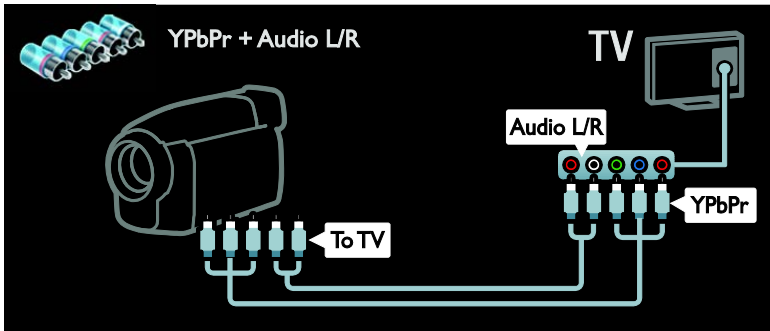

---

## Connect more devices

---

### External hard disk

Connect the external hard disk with a USB cable to the TV.

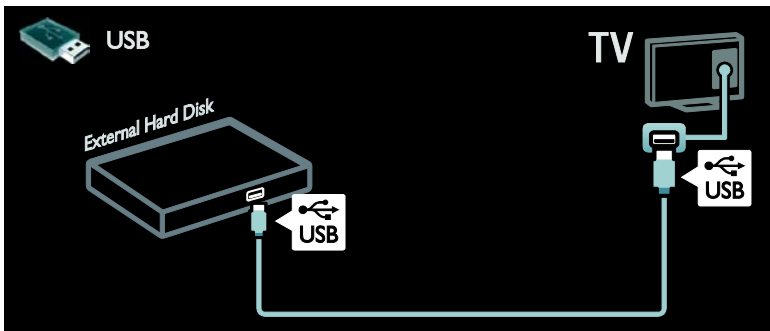

## Computer

Connect the computer with an HDMI cable to the TV.

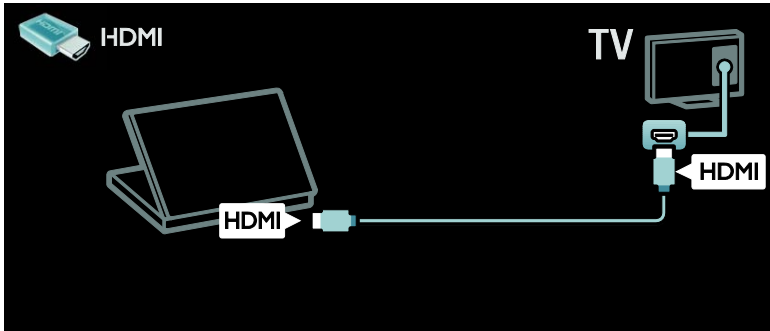

Connect the computer with a DVI-HDMI cable to the TV.

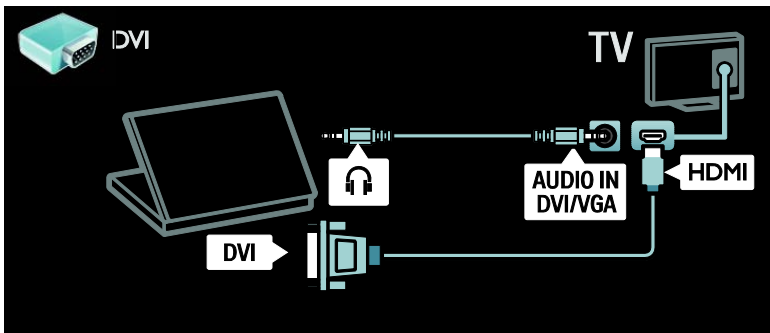

Connect the computer with a VGA cable and an audio cable to the TV.

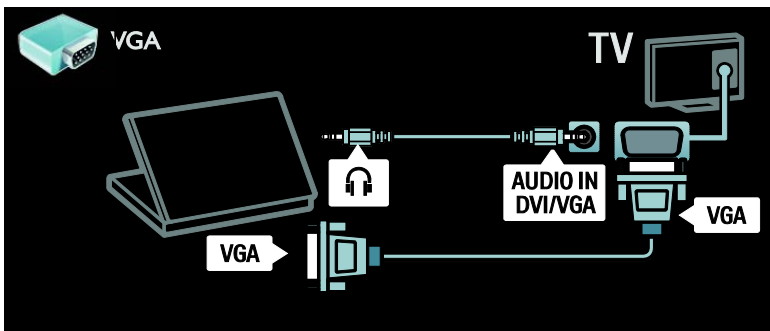

---

# Computers and the Internet

---

## What you can do

### Network benefits

If you connect your TV to a computer network with storage devices such as computers, you can play the photos, music and videos on your devices. See **Use your TV > Browse PC through DLNA** (Page 20).

If you connect your TV to a computer network with Internet access, you can access Net TV content. For more information about Net TV, see **Use your TV > Browse Net TV** (Page 21).

**Note:** If the apparatus does not recover in DLNA mode due to external electrical disturbances (e.g. electrostatic discharge), user intervention is required.

---

## What you need

**Warning:** This TV complies with the EMC directive only when you use a shielded Cat5 ethernet cable.

To connect your TV to computers, the Internet, or both, you need:

- An ethernet cable that is shorter than 3 metres.
- A computer network that includes:
  - a) A universal plug-and-play (UPnP) router and
  - b) A computer with one of these operating systems: Microsoft Windows XP, Microsoft Windows Vista, Mac OSX, or Linux.
- To connect your TV to computers, you also need media server software that is set to share files with your TV. See **Use your TV > Browse PC through DLNA** (Page 20).
- To connect your TV to the Internet, you also need a high-speed connection to the Internet.

**Note:** This DLNA1.5 network feature supports these computer operating systems: Microsoft Windows XP or Vista, Intel Mac OSX or Linux.

---

## Connect

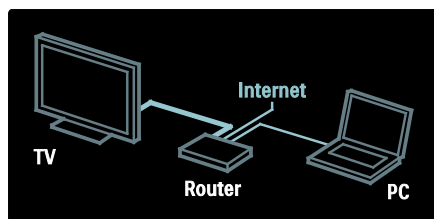

1. Switch on the router and switch on its DHCP setting.
2. With the ethernet cable, connect the router to the TV.

Alternatively, you can also connect the router to the TV wirelessly, through a wireless USB adaptor (not included). See **Connect your TV > Computers and the Internet > Wireless LAN ready** (Page 52).

3. Press **▲**, select **[Setup]** > **[Connect to network]**, then press **OK**.
4. Follow the onscreen instructions to install the network.
5. Wait for the TV to find the network connection.
6. If you are prompted, agree to the End User License Agreement.

---

## Wireless LAN ready

This TV is Wireless LAN ready. With the Wireless LAN adapter PTA01 accessory (sold separately), you can connect the TV to your home network wirelessly. You can enjoy the best of the web from Net TV services, and sharing of content between your devices connected to the home network using Wi-Fi MediaConnect or DLNA, seamlessly and hassle free.

**Note:**

- The wireless network operates in the same 2.4GHz frequency spectrum as common household devices, such as Dect phones, microwave ovens or Bluetooth devices, which can cause Wi-Fi interferences. Move these devices away from the TV with the connected Wireless USB adapter.
- You should turn off any unused network equipment in the home network as this increases network traffic.
- Reception quality is dependent on the location of the wireless router, as well as the quality of services provided by the local Internet Service Provider.
- When playing video over your wireless home network, we recommend that you use an IEEE 802.11 N router. The connection speed may differ according to the operating environment of your wireless home network.

### Make your TV wireless

1. Switch on your wireless network router.
2. Insert the USB adapter PTA01 into the USB connection at the side of the TV. The wireless installation starts automatically.
3. Follow the on screen instructions.

### WPS - Wi-Fi Protected Setup

If your router supports WPS (Wi-Fi Protected Setup), press the WPS button on the router. Return to the TV in 2 minutes, select **[WPS]** and press **OK**. The TV connects to your network. This takes about 2 minutes. Complete the installation.

Most new wireless routers have the WPS system and carry the WPS logo. The WPS system uses WPA security encryption and cannot be combined with devices on your network that use the WEP security encryption. If you still need this WEP device in your network, install with **[Scan]** > **[Custom]**.

### Scan for routers

If you have several routers in your network, you can select the network you need. To select a specific network router, press **[Scan]** on the first page of the installation.

The routers with WPS and the strongest signal are shown first in the list on screen.

Select the router you need. If you are connecting a WPS router, select **[WPS]** on the TV.

- If you have set the PIN code in your router software, select **[WPS pincode:]** and enter the code.
- To enter the encryption key manually, select **[Custom]** and enter the key.

### PIN code

To set the secured connection with a PIN code, select the PIN code and press **OK**. Write down the 8 digit PIN code shown on the TV and enter it in the router software on your PC. See the router manual for where to enter the PIN code.

### Custom

To enter the encryption key (the security key) manually, select **[Custom]** and press **OK**. If you have WPA security on your router, enter the passphrase with the remote control.

To access the on-screen keyboard, select the text entry field and press **OK**. If you have WEP security encryption, the TV asks for the WEP encryption key in hexadecimal numbers.

Find this hexadecimal key in the router software on your PC. Write down the first key of the WEP keys list and enter it on the TV with the remote control. If the security key is accepted, the TV is connected with the wireless router.

If asked, agree to the End User License Agreement.

If you are using the Wireless USB adapter, keep it connected to the USB connector on the TV.

---

## Wi-Fi MediaConnect

### What you can do

With Wi-Fi MediaConnect, you can project your PC screen on the TV wirelessly. With the \*Wi-Fi MediaConnect CD-ROM, you can download the software for free. Wi-Fi MediaConnect is only available for PC.

\*The Wi-Fi MediaConnect CD-ROM is supplied with the Wireless USB adapter, PTA01.

For Wi-Fi integrated models, the CD-ROM is supplied with the TV.

### What you need

To use **Wi-Fi MediaConnect**, you need the following:

- Connect the TV to your home network
- A wireless router
- A wireless USB adapter (only for TVs which are not Wi-Fi integrated).

For the availability of the wireless USB adapter, check with your local retailers or buy online at [www.philips.com/tv](http://www.philips.com/tv).

### Install Wi-Fi MediaConnect

1. Insert the Wi-Fi MediaConnect CD-ROM in your PC.
2. Your PC starts your Internet browser and opens the Wi-Fi MediaConnect download page - [www.philips.com/wifimediconnect](http://www.philips.com/wifimediconnect). On the website, you can check the necessary PC system requirements.
3. Enter the code printed on the CD-ROM envelope.
4. Click the 'Download now' button to download the free Wi-Fi MediaConnect software.
5. Once downloaded, start the file 'Wi-Fi MediaConnect\_setup.exe'. Follow the instructions on your PC.

### TV network name

If you have more than one TV in your home network, you can rename this TV. To rename this TV in the network, press **⬆ >** [**Setup**] > [**Network settings**] and select the TV network name.

To enter the name, press **OK** to open the on-screen keyboard or use the remote control keypad.

### Start projecting

To start projecting the PC screen on the TV, click on the small TV-like icon in the taskbar at the bottom right of the PC screen. Your PC screen appears on your TV screen.

### Stop projecting

To stop projecting, click on the TV icon again.

### Project your PC: Help

To read the Wi-Fi MediaConnect Help, right-click the program icon in the notification tray of the PC and select Help.

### Specifics

You can project high-definition (HD) or standard-definition (SD) video, depending on the processing power of your PC.

- Due to output content protection, certain commercial DVD or Blu-ray discs may not be projected.
- The TV shows PC media files with a small delay.
- Wi-Fi MediaConnect is available for PC only.

### Project your PC: PC requirements

Minimum specifications

- Windows XP, Vista, Windows 7 (PC only)
- Intel Pentium Core 2 Duo 1.8 GHz
- 512 MB RAM
- 200 MB free hard disk space
- Wi-Fi 802.11g
- Internet connection

### Project your PC: PC requirements

Recommended specifications

- Windows XP, Vista, Windows 7 (PC only)
- Intel Pentium Core 2 Duo 2.1 GHz
- 1 GB RAM
- 200 MB free hard disk space
- Wi-Fi 802.11n
- Internet connection

## Common interface

### What you can do

To watch some digital TV programmes, you need a Conditional Access Module (CAM).

If a CAM is inserted and subscription fees are paid, you can watch the channel. The applications, functions, the content and the onscreen messages vary for each CAM service.

### What you need

**Caution:** To protect the CAM from damage, insert the CAM according to these instructions.

#### Notes:

- This TV supports CI as well as CI+. CI+ allows service providers to offer premium HD digital programmes with a high level of copy protection.
- Refer to the documentation from your service operator on how to insert a smart card into the Conditional Access Module.

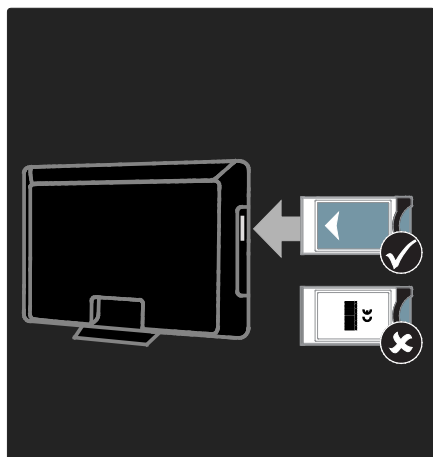

1. Switch off the TV.
2. Follow the directions printed on the CAM and insert the CAM into the Common Interface at the side of the TV.
3. Push the CAM in as far as it will go, then wait for the CAM to be activated. This takes a few minutes.

To prevent digital services from being deactivated, do not remove the CAM from the slot when it is in use.

### Watch CAM services

1. After inserting and activating the CAM, press **≡ OPTIONS**.
2. Select **[Common interface]**, then press **OK**.
3. Select the CAM provider and press **OK**.

# 6 Troubleshooting

---

## Contact Philips

**Warning:** Do not attempt to repair the TV yourself. This may cause severe injury, irreparable damage to your TV or void your warranty.

If you cannot resolve your problem, refer to the frequently asked questions (FAQs) for this TV at [www.philips.com/support](http://www.philips.com/support).

You can also contact Philips Consumer Care in your country for support. You can find the contact number in the leaflet that accompanies the TV.

Take a note of your TV model and serial number before you contact Philips. These numbers are printed on the back of the TV and on the packaging.

---

## General TV

**The TV does not switch on:**

- Disconnect the power cable from the power outlet. Wait for one minute then reconnect it.
- Make sure that the power cable is securely connected.
- Make sure that the **power switch** at the base or back of the TV is switched on.

**The TV does not respond to remote control or front controls when switched on**

The TV requires some time to start up. During this time, the TV does not respond to the remote control or front controls. This is normal behavior.

**The standby light on the TV blinks red:**

Disconnect the power cable from the power outlet. Wait until the TV cools down before you reconnect the power cable. If the blinking reoccurs, contact Philips Consumer Care.

You forgot the code to unlock the child lock feature:

Enter '8888'.

**The TV menu is in the wrong language:**

Change the TV menu to your preferred language.

For more information, see **Set up your TV > Menu language** (Page 40).

**When you are turning the TV on, off or to standby, you hear a creaking sound from the TV chassis:**

No action is required. The creaking sound is due to the normal expansion and contraction of the TV as it cools and warms up. This does not affect performance.

**When the TV is in standby, a startup splash screen is displayed, then returns to standby mode:**

This is normal behavior. When the TV is disconnected and reconnected to the power supply, the startup screen is displayed at the next startup.

To switch on the TV from standby, press  on the remote control or press any key on the front of the TV.

---

## TV channel

**Previously installed channels do not appear in the channel list:**

Make sure that the correct channel list is selected.

**No digital channels were found during the installation:**

- Make sure that the TV supports DVB-T, DVB-C or DVB-S in your country.
- Make sure that the antenna is properly connected and the correct network is selected.

---

## Picture

**The TV is on, but there is no picture or the picture is distorted:**

- Make sure that the antenna is properly connected to the TV.



- Make sure that the correct device is selected as the display source.
- Make sure that the external device or source is properly connected.

#### **There is sound but no picture:**

Make sure that the picture settings are set correctly.

#### **There is poor TV reception from an antenna connection:**

- Make sure that the antenna is properly connected to the TV.
- Loud speakers, unearthed audio devices, neon lights, high buildings and other large objects can influence reception quality. If possible, try to improve the reception quality by changing the antenna direction or moving devices away from the TV.
- If reception on only one channel is poor, fine-tune this channel.

#### **There is poor picture quality from connected devices:**

- Make sure that the devices are connected properly.
- Make sure that the picture settings are set correctly.

#### **The TV did not save your picture settings:**

Make sure that the TV location is set to **Home**. You can change and save settings in this mode.

#### **The picture does not fit the screen; it is too big or too small:**

Try a different picture format.

#### **The picture position is incorrect:**

Picture signals from some devices may not fit the screen correctly. Check the signal output of the device.

#### **The picture from broadcasts is scrambled:**

You may need a Conditional Access Module to access content. Check with your service operator.

#### **An "e-sticker" banner displaying information appears on the TV display:**

The TV is in **[Shop]** mode. To remove the e-sticker, set the TV to **[Home]** mode, then restart the TV. **Position the TV > Location** (Page 10).

#### **The computer display on the TV is not stable:**

- Make sure that your PC uses the supported resolution and refresh rate. See **Product specifications > Display resolutions** (Page 59).
- Set the TV picture format to **[Unscaled]**.

---

## Sound

#### **There is a picture but sound quality is poor:**

If no audio signal is detected, the TV automatically switches the audio output off — this does not indicate malfunction.

- Make sure that all cables are properly connected.
- Make sure that the volume is not muted or set to zero.
- Make sure that the TV speakers setting is selected. Press **III ADJUST**, select **[Speakers]**, and then select **TV**.
- Make sure that the TV audio output is connected to the audio input on the HDMI-CEC enabled or EasyLink compliant home theatre device. Sound should be heard from the home theatre speakers.

#### **There is a picture but the sound quality is poor:**

Make sure that the sound settings are correctly set.

#### **There is a picture but sound comes from one speaker only:**

Make sure that sound balance is set to the centre.

---

## HDMI

### There are problems with HDMI devices:

- Note that HDCP (High-bandwidth Digital Content Protection) support can delay the time taken for a TV to display content from a HDMI device.
- If the TV does not recognise the HDMI device and no picture is displayed, switch the source from one device to another and back again.
- If there are intermittent sound disruptions, make sure that output settings from the HDMI device are correct.
- If you use an HDMI-to-DVI adapter or HDMI to DVI cable, make sure that an additional audio cable is connected to AUDIO L/R or AUDIO IN (mini-jack only).

### You cannot use EasyLink features:

Make sure that your HDMI devices are HDMI-CEC compatible. EasyLink features only work with devices that are HDMI-CEC compatible.

### If an HDMI-CEC compliant audio device is connected to the TV and the TV does not display any mute or volume icon when the volume is muted, increased or decreased.

This behaviour is normal when an HDMI-CEC audio device is connected.

---

## USB

### USB device content is not displayed:

- Make sure that the USB storage device is set to **Mass Storage Class** compliant, as described in the storage device's documentation.
- Make sure that the USB storage device is compatible with the TV.
- Make sure that the audio and picture file formats are supported by the TV.

### Audio and picture files do not play or display smoothly:

The transfer performance of the USB storage device may limit the data transfer rate to the TV which causes poor playback.

---

## Network

### Net TV does not work

If the connection to the router is properly set up, check the router connection to the Internet.

### Browse PC or Net TV access is slow.

Refer to your router's user manual for information on transfer rate and other factors of signal quality.

You need a high-speed Internet connection for your router.

### Wireless network is distorted or not found.

- Make sure that the wireless network is not disturbed by microwave ovens, DECT phones or other neighbouring Wi-Fi devices.
- If the wireless network is not working, try a wired network connection.
- For DLNA connection, click on **How does sharing change firewall settings** in the **Media Sharing** window for the Help file.

# 7 Product specifications

## Power and reception

### Power

- Mains power : AC 220-240 V~, 50/60 Hz
- Standby power consumption : <0.15 W
- Ambient temperature: 5 to 40 degrees Celsius
- For power consumption, see the product specifications at [www.philips.com/support](http://www.philips.com/support).

### Reception

- Antenna input: 75 ohm coaxial (IEC75)
- TV system: DVB COFDM 2K/8 K,
- Video playback: NTSC, PAL, SECAM
- Digital TV: MPEG-4, DVB-T (Terrestrial), \*DVB-T2, DVB-C (Cable), \*DVB-S/S2 (Satellite).
- Tuner bands: VHF, UHF, S-Channel, Hyperband

\*Available on certain models only.

## Display and sound

### Picture/Display

- Display type: edge LED backlight
- Diagonal size:
  - 81 cm/32 inch
  - 94 cm/37 inch
  - 107 cm/42 inch
  - 119 cm / 47 inch
  - 140 cm / 55 inch
- Aspect ratio: 16:9 (widescreen)
- Panel resolution: 1920x1080p
- Picture enhancement: Pixel Precise HD/ 100 Hz Clear LCD

### Picture/Display

- HD Natural Motion - For PFL7x06 series, PFL7466 series and PFL7666 series

- Perfect Natural Motion - For PFL7xx6 series
- Ambilight: Ambilight Spectra 2
- 3D: 3D TV (PFL76x6 series only)

### Sound

- Output power (RMS):
  - For PFL7x06 series: 24 W
  - For PFL7xx6 series: 28 W
- Incredible Surround
- Clear Sound
- Dynamic Bass Enhancement
- Mono / Stereo / NICAM

## Display resolutions

### Computer formats - HDMI (Resolution - refresh rate)

640 × 480 - 60 Hz  
 800 × 600 - 60 Hz  
 1024 × 768 - 60 Hz  
 1280 × 1024 - 60 Hz  
 1360 × 768 - 60 Hz  
 1600 × 1200 - 60 Hz  
 1920 × 1080 - 60 Hz

### Computer formats - VGA (Resolution - refresh rate)

640 × 480 - 60 Hz  
 800 × 600 - 60 Hz  
 1024 × 768 - 60 Hz  
 1280 × 1024 - 60 Hz  
 1360 × 768 - 60 Hz  
 1600 × 1200 - 60 Hz  
 1920 × 1080 - 60 Hz

### Video formats (Resolution - refresh rate)

480i - 60 Hz  
 480p - 60 Hz  
 576i - 50 Hz  
 576p - 50 Hz  
 720p - 50Hz, 60 Hz  
 1080i - 50Hz, 60 Hz  
 1080p - 24Hz, 25Hz, 30Hz, 50Hz, 60 Hz

# Multimedia

- Ethernet LAN RJ-45

## Supported image files

- JPEG (\*.jpg)

## Supported multimedia connections

- USB (FAT or DOS-formatted; Mass Storage Class compliant with 500mA only)
- SD card (Videostore)

## Supported audio/video files

Multimedia file names must not exceed 128 characters.

File Extension	Container	Video Codec	Resolution	Frame Rate (fps)	Bit Rate (Mbps)	Audio Codec	USB	DLNA	Nas TV	Open Internet	Video Store
.avi	AVI	MPEG4 SP	640x480p	30	3	AAC	Yes	Yes	No	No	No
		MPEG4 ASP	720x576p	30	8	MPEG1 L2/AAC3	Yes	Yes	No	No	No
.mkv	MPV	H.264	1920x1080p	24	20	HE-AAC, AAC3, MP3, PCM	Yes	Yes	No	No	No
.asf .wmv	ASF	WMV9/VC1 SP	352x288p	15	0.384	WMA	Yes	Yes	Yes	No	Yes
		WMV9/VC1 MP	1920x1080p	25/30	20	WMA	Yes	Yes	Yes	No	Yes
		WMV9/VC1 AP	1920x1080p	24/30/60	20	WMA	Yes	Yes	Yes	No	Yes
.mp4	MP4	H.264 BP	720x576i	15/30	5	AAC/HE-AAC (v1.82)/AAC3	Yes	Yes	Yes	No	Yes
		H.264 MP	720x576i	15/30	10	AAC/HE-AAC (v1.82)/AAC3	Yes	Yes	Yes	No	Yes
		H.264 HP	1920x1080i	15/30	20	AAC/HE-AAC (v1.82)/AAC3	Yes	Yes	Yes	No	Yes
		MPEG4 SP	640x480p	30	3	AAC	Yes	Yes	Yes	No	Yes
		MPEG4 ASP	720x576i	30	8	AAC	Yes	Yes	Yes	No	Yes

File Extension	Container	Video Codec	Resolution	Frame Rate (fps)	Bit Rate (Mbps)	Audio Codec	USB	DLNA	Nas TV	Open Internet	Video Store
.ts	TS	MPEG2	1920x1080p	30	20	MPEG2 L2/MPEG1	Yes	Yes	No	No	No
.mpeg .mpeg .vob	PS	MPEG2	1920x1080p	30	20	MPEG2 L2/MPEG1 L2/AAC3 LPCM1	Yes	Yes	No	No	No
		MPEG1	352x288	30	1.5	MPEG1 L2	Yes	Yes	No	No	No

## Supported DLNA-compliant media server software

- Windows Media Player (for Microsoft Windows)
- Twonky Media (for Microsoft Windows and Mac OS X)
- Sony Vaio Media Server (for Microsoft Windows)
- TVersion (for Microsoft Windows)
- Nero MediaHome
- DiXiM (for Microsoft Windows XP)
- Macrovision Network Media Server (for Microsoft Windows)
- Fuppes (for Linux)

- uShare (for Linux)

# Connectivity

## Rear

- EXT 1: SCART (RGB/CVBS)
- Component and Audio: Y Pb Pr, Audio L/R
- Service port: SERV.U
- Headphones: stereo 3.5mm mini-jack
- SAT: F-pin (Satellite). Available on certain models only.

**Bottom**

- Ethernet LAN RJ-45
- DIGITAL AUDIO OUT: Optical
- HDMI 1 - 3
- AUDIO IN: DVI/VGA (stereo 3.5mm mini-jack)
- Antenna: 75 ohm coaxial
- VGA: PC input

**Side**

- Common Interface: CI
- SD card (Video stores)
- 2 × USB
- HDMI

**HDMI features**

- Audio Return Channel (HDMI 1 only)
- 3D

# Dimensions

**Note:** Dimensions and weights are approximate values only. Design and specifications are subject to change without notice.

## Legend for TV dimensions

The legends used to indicate the TV dimensions are as follows:

- ( ) : 81 cm / 32 inch TV
- { } : 94-cm/37-inch TV
- [ ] : 107-cm/42-inch TV
- (( )) : 119 cm / 47 inch TV
- {{ }} : 140 cm / 55 inch TV

Take a note of the legend that corresponds to your TV. Then, go to the next page to view the dimensions.

Use your TV legend to note the weight of the TV without the stand.

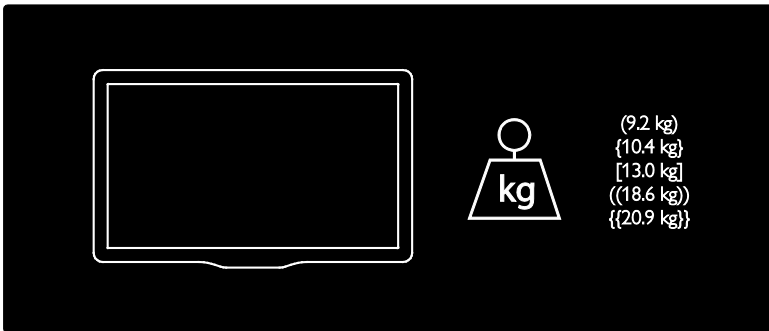

Use your TV legend to note the weight of the TV with stand.



Use your TV legend to note the dimensions of your TV (with and without the stand).

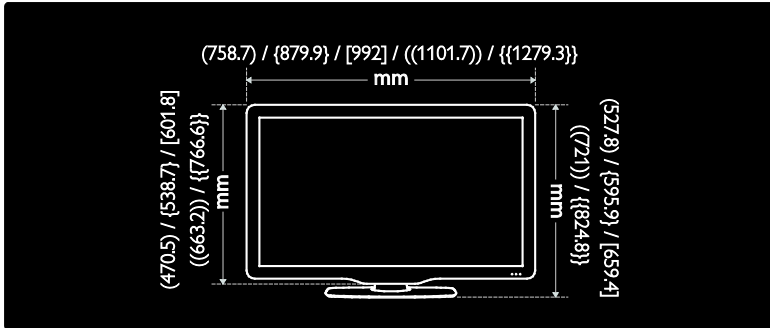

Use your TV legend to note the thickness of your TV (with and without the stand).

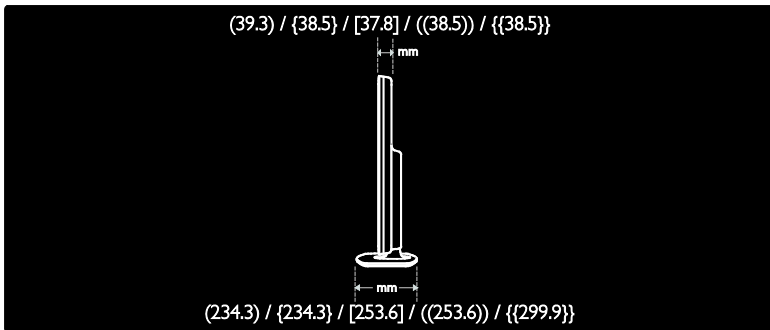

## Help version

UMv 3139 137 04521- 20110330

# 8 Index

---

## 3

3D - 17

3D glasses - 7

3D, health warning - 7

---

## A

age rating - 30

analogue channels, fine-tune - 39

analogue channels, subtitles - 30

audio language - 37

---

## C

CAM, enable - 55

CAM, insert - 55

CAM, see Conditional Access Module - 55

care - 7

channel list - 15

channels, favourites - 15

channels, fine-tune (analogue) - 39

channels, hide or unhide - 38

channels, install (automatic) - 38

channels, install (manual) - 39

channels, reinstall - 40

channels, rename - 37

channels, reorder - 37

channels, switch - 14

channels, update - 38

child lock - 30

clock - 29

common interface - 55

computer, play files - 21

computer, see PC - 52

Conditional Access Module - 55

connect device - 44

connect, PC - 51

connect, USB - 17

connectors - 4

contact information, on Internet - 10

contact Philips - 10

controls - 11

---

## D

demo - 40

devices, add - 16

devices, watch - 16

digital channels - 39

digital channels, subtitles - 30

digital radio - 15

dimensions - 62

display - 59

display resolution - 59

DLNA - 20

---

## E

EasyLink, controls - 33

EasyLink, enable - 33

EasyLink, features - 32

EasyLink, RC key forward - 33

EasyLink, TV speakers - 34

Electronic Programme Guide - 15

end of use - 8

environment efforts - 8

environment, recycle - 8

EPG, menu - 15

---

## F

factory settings - 37

favourites list, add - 15

---

## H

HbbTV - 25

HbbTV, block reception - 25

HDMI - 43



HDMI ARC - 43

hearing impaired - 31

help, onscreen - 10

high-definition (HD), content - 5

home menu - 3

home mode - 10

---

## I

install channels - 38

install channels (automatic) - 38

install channels (manual) - 39

---

## K

kensington lock - 10

---

## L

language, menu - 40

location, home or shop - 10

---

## M

multimedia - 60

multimedia, play files - 17

mute TV speakers - 34

---

## N

Net TV, browse - 21

---

## O

online video, rent - 23

---

## P

Pause live broadcast - 26

PC, connect - 51

PC, display resolutions - 59

picture format - 36

picture settings - 36

Pixel Plus link - 34

placement, stand or wall mount - 9

position the TV - 9

power - 59

---

## R

recycle - 8

register product - 10

reinstall TV - 42

remote control - 11

remote control, batteries - 12

remote control, onscreen - 33

remote control, overview - 11

rename channels - 37

reorder channels - 37

---

## S

safety - 6

Scenea, enable - 31

Scenea, see screen saver - 31

screen saver - 31

SD card, format - 23

SD card, memory size - 23

settings, assistant - 36

settings, picture - 36

settings, sound - 36

shop mode - 10

sleeptimer - 30

smart sound - 36

Smart USB - 25

software, Internet update - 41

software, version - 41

sound settings - 36

subtitle, analogue - 30

subtitle, digital - 30

subtitle, language - 31

---

## T

teletext 2.5 - 29

teletext, digital text - 29

teletext, dual screen - 28

teletext, enlarge - 28  
teletext, language - 29  
teletext, search - 29  
teletext, subpages - 29

---

## U

universal access, enable - 31  
universal access, hearing impaired - 31  
universal access, visually impaired - 32  
USB recording - 27

---

## V

visually impaired - 32  
volume - 11

---

## W

wall mount - 9  
wallpaper - 31  
Wi-Fi MediaConnect - 53  
Wireless LAN ready - 52



© 2011 Koninklijke Philips Electronics N.V.  
All rights reserved.  
Document order number 313913704521