

Register your product and get support at
www.philips.com/welcome

CINEOS

32PFL7403

42PFL5603

47PFL5603

42PFL5403



EN LCD television

310431527271



PHILIPS

Table of contents

1 Important 3

- 1.1 Safety 3
 - 1.2 Care of the screen 3
 - 1.3 Recycling 3
-

2 Your TV 4

- 2.1 Television overview 4
 - 2.2 Product highlights 5
-

3 Getting started 5

- 3.1 Position the TV 5
 - 3.2 Wall mounting - VESA 6
 - 3.3 Remote control batteries 7
 - 3.4 Antenna cable 7
 - 3.5 Power cable 7
-

4 Use your TV 8

- 4.1 Turn on or off - Standby 8
 - 4.2 Watch TV 8
 - 4.3 Watch channels from a digital receiver 9
 - 4.4 Watch connected devices 9
 - 4.5 Watch a DVD 9
 - 4.6 Select a Teletext page 9
-

5 Use more of your TV 10

- 5.1 Remote Control 10
 - 5.2 TV menus 11
 - 5.3 Picture and sound settings 13
 - 5.4 Teletext 16
 - 5.5 Create favourite channel lists 17
 - 5.6 Electronic Programme Guide 18
 - 5.7 Timers and locks 19
 - 5.8 Subtitles 20
 - 5.9 Watch and play photos, MP3... 21
 - 5.10 Listen to digital radio channels 22
 - 5.11 Software update 23
-

6 Channel installation 25

- 6.1 Automatic channel installation 25
 - 6.2 Manual channel installation 26
 - 6.3 Rearrange stored channels 26
 - 6.4 Channel management 27
 - 6.5 Digital reception test 27
 - 6.6 Factory settings 27
-

7 Connections (DVD, receiver, ...) 28

- 7.1 Connections overview 28
 - 7.2 About connections 29
 - 7.3 Connect your devices 31
 - 7.4 Setup devices 34
-

8 Technical data 36

9 Troubleshooting 37

10 Index 39

Register your product and get support at www.philips.com/welcome.

2008 © Koninklijke Philips Electronics N.V. All rights reserved. Specifications are subject to change without notice. Trademarks are the property of Koninklijke Philips Electronics N.V. or their respective owners.

Philips reserves the right to change products at any time without being obliged to adjust earlier supplies accordingly.

The material in this manual is believed adequate for the intended use of the system. If the product, or its individual modules or procedures, are used for purposes other than those specified herein, confirmation of their validity and suitability must be obtained. Philips warrants that the material itself does not infringe any United States patents. No further warranty is expressed or implied.

Warranty

No components are user-serviceable. Do not open or remove covers and do not insert objects in the ventilation slots or insert objects not suitable for the specific connectors. Repairs may only be done by Philips Service Centres and official repairshops. Failure to do so shall void any warranty, stated or implied.

Any operation expressly prohibited in this manual, any adjustments, or assembly procedures not recommended or authorised in this manual shall void the warranty.

Pixel characteristics

This LCD product has a high number of colour pixels. Although it has effective pixels of 99,999% or more, black dots or bright points of light (red, green or blue) may appear constantly on the screen. This is a structural property of the display (within common industry standards) and is not a malfunction.

Open source software

This television contains open source software. Philips hereby offers to deliver or make available, upon request, for a charge no more than the cost of physically performing source distribution, a complete machine-readable copy of the corresponding source code on a medium customarily used for software interchange. This offer is valid for a period of 3

years after the date of purchase of this product.

To obtain the source code, write to Philips Innovative Applications N.V. Ass. to the Development Manager Pathoekeweg 11 B-8000 Brugge Belgium

Compliance with EMF

Koninklijke Philips Electronics N.V. manufactures and sells many products targeted at consumers, which, like any electronic apparatus, in general have the ability to emit and receive electromagnetic signals.

One of Philips' leading Business Principles is to take all necessary health and safety measures for our products, to comply with all applicable legal requirements and to stay well within the EMF standards applicable at the time of producing the products.

Philips is committed to develop, produce and market products that cause no adverse health effects.

Philips confirms that if its products are handled properly for their intended use, they are safe to use according to scientific evidence available today.

Philips plays an active role in the development of international EMF and safety standards, enabling Philips to anticipate further developments in standardisation for early integration in its products.

Copyrights



VESA, FDMI and the VESA Mounting Compliant logo are trademarks of the Video Electronics Standards Association.



Manufactured under license from Dolby Laboratories. 'Dolby', 'Pro Logic' and the double D symbol **DD**, are trademarks of Dolby Laboratories.



Manufactured under license from BBE Sound, Inc. Licensed by BBE, Inc under one or more of the following US patents: 5510752, 5736897. BBE and BBE symbol are registered trademarks of BBE Sound Inc.



The "HD Tick" Logo is a trademark of AEEMA.

Windows Media is either a registered trademark or trademark of Microsoft Corporation in the United States and/or other countries

® Kensington and MicroSaver are registered US trademarks of ACCO World Corporation with issued registrations and pending applications in other countries throughout the world.

All other registered and unregistered trademarks are the property of their respective owners.

1 Important

Read this user manual before you start to use this product.

Pay attention to this section and closely follow the instructions. The warranty does not apply to damage caused by not taking into account the instructions.

1.1 Safety

- To avoid short circuit, do not expose the product to rain or water.
- To avoid a risk of fire or electric shock do not place naked flame sources (e.g. lighted candles) close to the TV.
- Leave a space of at least 10cm (4 inches) all around the TV for ventilation.
- Keep away from radiators or other heat sources.
- Do not install the TV in a confined space such as a book case. Make sure that curtains, cupboards and so on cannot obstruct the air flow through the ventilation slots.
- To prevent damage, do not insert any object into the ventilation slots.
- Make sure the TV cannot fall down. Place the TV on a solid and flat surface and only use the stand provided with the TV.
- To prevent damaging the mains cord, do not place the TV, or anything else, on the cord. Damage to the cord may cause a fire or electric shock.
- When mounted on a swivel stand or VESA wall bracket avoid force coming on the mains plugs. Mains plugs that are partly loosened can cause arcing or fire.

1.2 Care of the screen

- Unplug the TV before cleaning.
- Clean the surface with a soft damp cloth. Do not apply any other substance (chemical or household cleaning agent). This may damage the screen.
- Do not touch, push or rub or strike the screen with anything hard as this may scratch, mar or damage the screen permanently.
- To avoid deformations and colour fading, wipe off water drops as soon as possible.

- Stationary images
Avoid stationary images as much as possible. If you cannot, reduce screen contrast and brightness to prevent damage to the screen. Stationary images are images that remain on the screen for a long time. Examples of stationary images are: on screen menus, teletext pages, black bars, stock market information, TV channel logos, time displays, and so on.

1.3 Recycling

- Take the packaging to your local recycling centre.
- Dispose old batteries safely according local regulations.
- This product is designed and manufactured for material recycling and re-use.
- Do not dispose this product with other household waste. Inform yourself or ask your dealer about local environmentally safe recycling and local regulations. Uncontrolled waste disposal harms the environment and human health. (EEC 2002/96/EC)



2 Your TV

This section gives you an overview of the controls and functions of this TV.

2.1 Television overview

Control

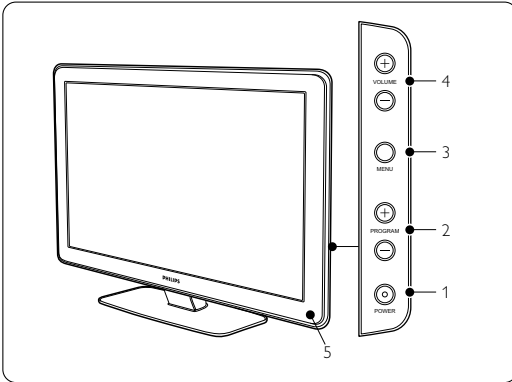

- 1 Power switch
- 2 Program/Channel up and down
- 3 Menu
- 4 Volume up and down
- 5 Remote control sensor

Connectors

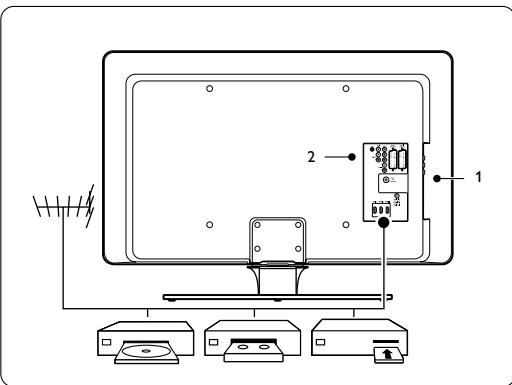

- 1 Back connectors
- 2 Side connectors

For more info see section **7 Connections**.

Remote control

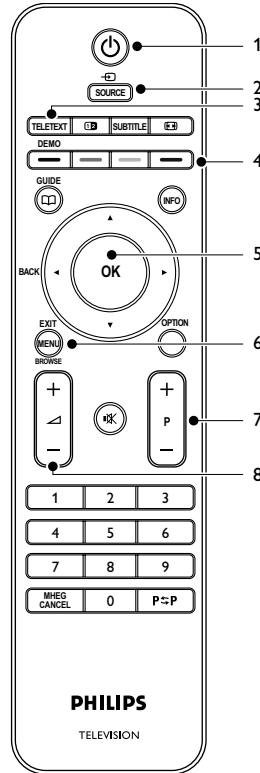

- 1 Turn On or switch to Standby
- 2 Source
- 3 Teletext
- 4 Colour keys
- 5 Navigation keys
- 6 Menu On or Off
- 7 Program/Channel up **+** and down **-**
- 8 Volume up **+** or down **-**

For more info see section **5.1 Remote control overview**.

2.2 Product highlights

Your new TV is equipped with some of the most modern audio or video innovations. Your TV offers the following advantages ...

Full High Definition LCD display (42-47PFL5603D only)

A full HD resolution of 1920x1080p, the highest resolution of HD sources. It offers a brilliant flicker-free progressive scan picture with optimum brightness and superb colours.

Pixel Plus

Offers perfect picture quality from any source.

100Hz Clear LCD

100Hz Clear LCD gives a superior motion sharpness, better black level, high contrast with a flicker-free, quiet image and a larger viewing angle.

DVB-T integrated tuner

Next to normal analogue TV broadcast your TV receives digital terrestrial TV and radio broadcasts. Digital broadcasting Australia : see www.dba.org.au

Electronic Programme Guide - EPG

The EPG shows the scheduled digital TV programmes on screen. The guide can remind you when programmes start, switch the TV on, etc.

HDMI connectors

HDMI connectors for highest quality high definition connectivity.

USB connection

Multimedia connection for instantly view or play your photos or music.

3 Get started

This section helps you with the positioning and the first time installation of the TV.

3.1 Position the TV

Carefully read the safety precautions in section 1.1 Safety before you position the TV.

- Large screen TVs are heavy. Carry and handle the TV with at least two persons.
- The ideal distance from which to watch TV is three times its diagonal screen size.
- Position the TV where light does not fall directly on the screen.
- Your TV is equipped with a Kensington Security Slot at the back of the TV for an anti-theft lock (not supplied).

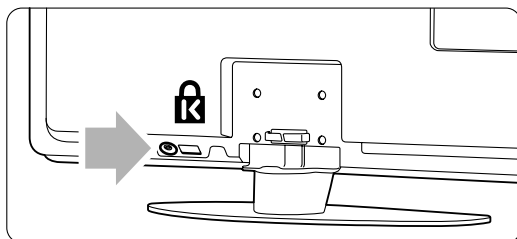

On 32" TV model.

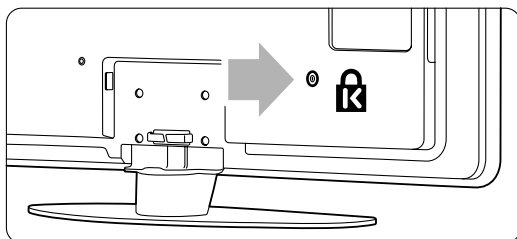

On 42" and 47" TV model.

3.2 Wall mounting - VESA

Warning

Wall mounting of the TV should only be performed by qualified installers. Koninklijke Philips Electronics N.V. bears no responsibility for improper mounting that results in accident or injury.

Step 1 Purchase a VESA-compatible wall bracket

Depending on the size of your TV screen, purchase one of the following wall brackets:

TV screen size (inches/cm)	VESA-compatible wall bracket type (millimeters)	Special instructions
32"/81cm	Adjustable 300 x 300	The VESA-compatible bracket must be adjusted to 200 x 300 before securing to the TV
42"/107cm or larger	Fixed 400 x 400	None

Step 2 Remove the TV stand

Note

These instructions are only applicable to TV models with mounted stands. If your TV stand is not mounted, skip to **Step 3 Secure the VESA-compatible wall bracket to the TV**.

- 1 Carefully place the TV face down on a flat, stable surface that is covered by soft cloth. The cloth should be thick enough to protect your screen.

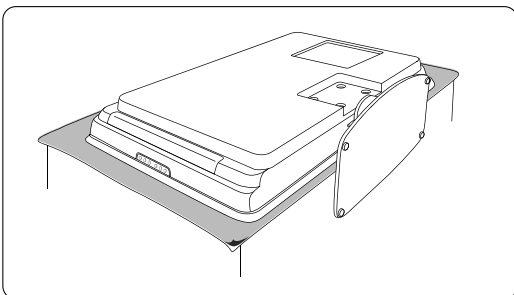

- 2 Using a cross-head screwdriver (not supplied), unscrew the four bolts that secure the stand to the TV.

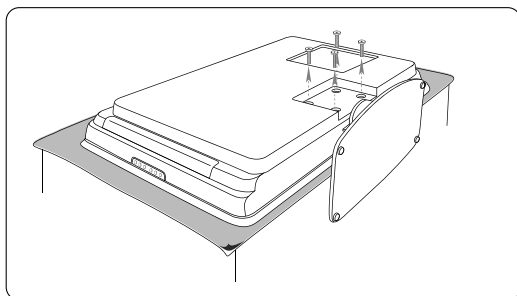

- 3 Firmly pull the stand from the bottom of the TV. Place both the stand and bolts in a secure location for future reinstallation.

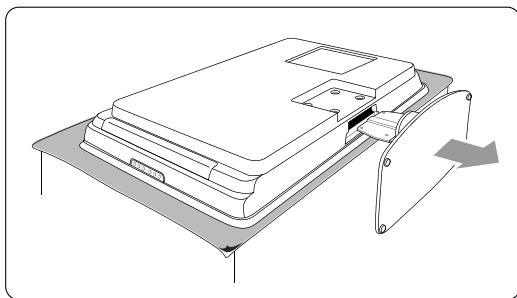

Step 3 Secure the VESA-compatible wall bracket to the TV

- 1 Locate the four mounting nuts at the back of the TV.

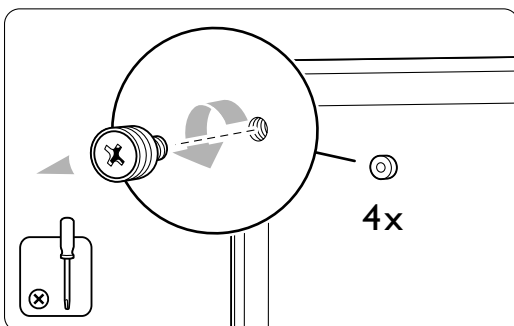

- 2 Continue with the instructions provided with your VESA-compatible wall bracket.

Note

When securing the VESA-compatible wall bracket to your TV, use M6 bolts for 32 inch models or M8 bolts for larger models (bolts not supplied).

3.3 Remote control batteries

- 1 Open the battery cover on the back of the remote control.
- 2 Insert the 2 batteries supplied (Type AAA-LR03-1,5V). Make sure the + and - ends of the batteries line up correctly (inside of case is marked.)
- 3 Close the cover.

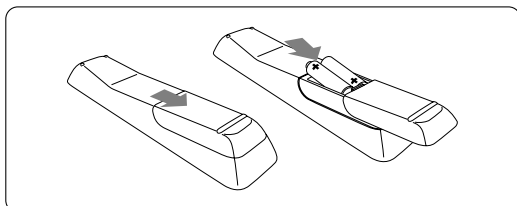

Note

Remove the batteries if not using the remote control for an extended period of time.

3.4 Antenna cable

- 1 Locate the antenna connection at the back of the TV.
- 2 Insert the antenna cable tightly into the Antenna socket.

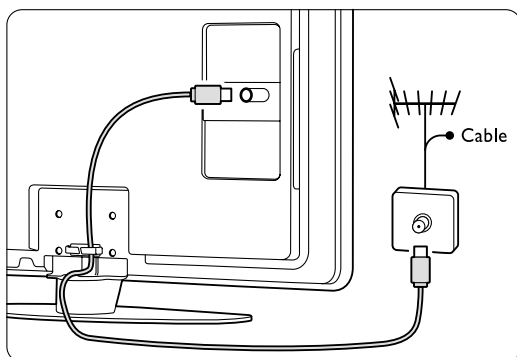

3.5 Power cable

Keep the mains plug at the wall socket accessible at all time.

The TV is never powered off completely and consumes energy unless the mains cord is physically unplugged.

Although this TV has a very low standby power consumption, unplug the mains cord if you do not use the TV for a long time to save energy.

- 1 Verify that your mains voltage corresponds with the voltage printed on the sticker at the back of the TV. Do not insert the mains cord if the voltage is different.
- 2 Insert the mains cord tightly.

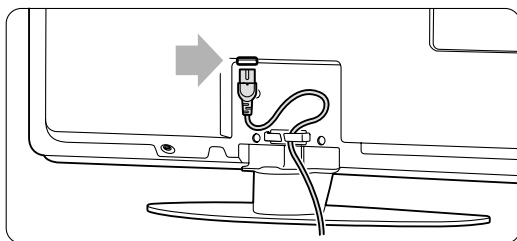

On 32" TV model.

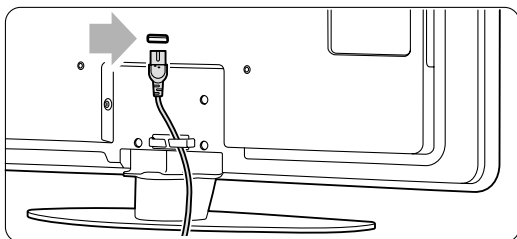

On 42" and 47" TV models.

Note

The location of the mains connector varies according to the TV model.

4 Use your TV

Learn how to operate your TV for daily use.

4.1 Turn on or off - Standby

Note

The TV may take up to 15 seconds to turn on.

To turn on the TV:

- Press **Power** at the right of the TV if the standby indicator is off.
- Press **Power** on the remote control if the standby indicator is on.

To switch to standby:

- Press **Power** on the remote control.

To turn off:

- Press **Power** at the side of the TV.

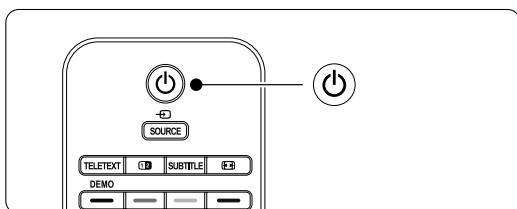
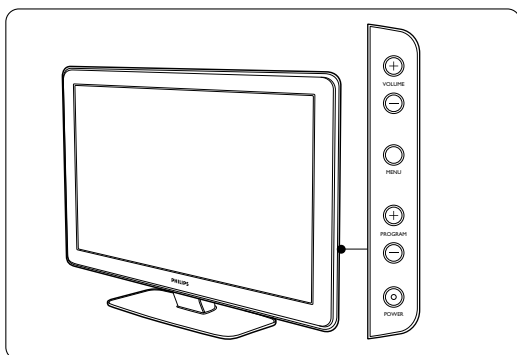

4.2 Watch TV

4.2.1 Switch channels

1 To switch TV channels:

- Press a number (1 to 999) or press **P+** or **P-** on your remote control.
- Press **Program/Channel -** or **+** on the side controls of the TV.

2 Press **P=P** to return to the previously viewed TV channel or connected device.

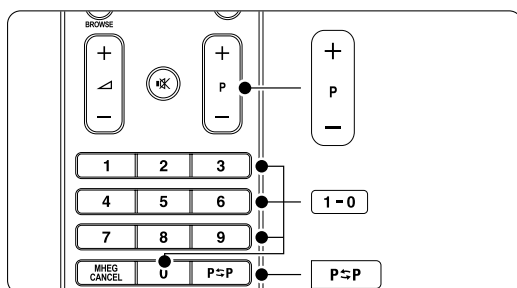

4.2.2 Adjust volume

1 To adjust the volume:

- Press **+ or -** on the remote control
- Press **Volume + or -** on the side controls of your TV.

2 To mute the sound:

- Press **Mute**.
- Press **Mute** again to restore the sound.

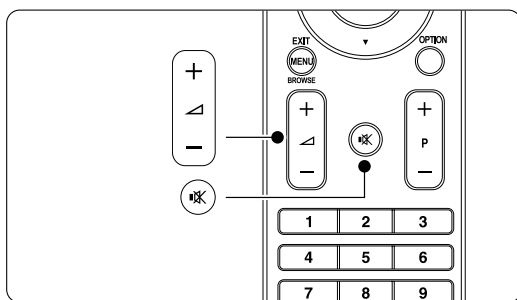

4.3 Watch channels from a digital receiver

- 1 Switch on the digital receiver.
The picture from your receiver automatically appears on the screen.
- 2 Use the remote control of your digital receiver to select TV channels.

If the picture does not appear:

- 1 Press the **Source**  key.

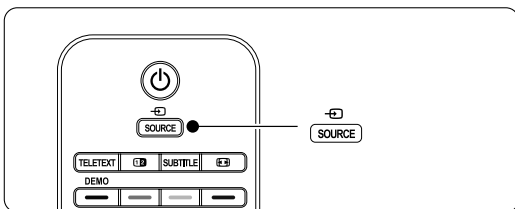

- 2 Press \blacktriangle or \blacktriangledown to select where you connected your digital receiver.
- 3 Press **OK**.

Note

When you did not connect your devices yet, go to section **7 Connections**.

4.4 Watch connected devices

- 1 Switch on the device.
The picture from your device automatically appears on the screen.

If the picture does not appear:

- 2 Press the **Source**  key.
- 3 Press \blacktriangle or \blacktriangledown to select where you connected your device.
- 4 Press **OK**.

Note

When you did not connect your devices yet, go to section **7 Connections**.

4.5 Watch a DVD

- 1 Switch on your DVD player.
- 2 Insert a DVD disc in your player.
The DVD picture automatically appears on the screen.
- 3 Press **Play** \blacktriangleright on the DVD player.

If the picture does not appear:

- 1 Press the **Source**  key.
- 2 Press \blacktriangle or \blacktriangledown to select where you connected your DVD player.
- 3 Press **OK**.
Wait a few seconds until the picture appears.
- 4 Press **Play** \blacktriangleright .

4.6 Select a Teletext page

Most TV channels broadcast information through Teletext.

To watch Teletext:

- 1 Press **Teletext**.
The main index page appears.

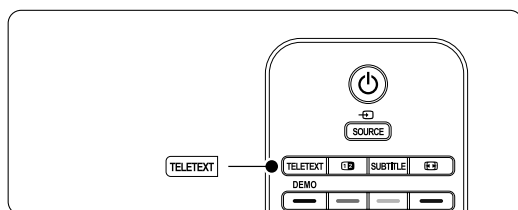

- 2 To select a page of your choice:
 - Enter the page number with the number keys.
 - Press **P-** or **P+** or \blacktriangle or \blacktriangledown or the \leftarrow key to view the next or the previous page.
 - Press a colour key to select one of the colour coded items at the bottom of the screen.
 - Press **P=P** to return to the previously viewed page.
- 3 Press **Teletext** again to switch Teletext off.

For more information on teletext, see section **5.4 Teletext**.

5 Use more of your TV

This section helps you perform advanced TV operations including how to:

- use the menus
- adjust picture and sound settings
- make use of Teletext
- create favourite channel lists

- make advantage of Electronic Programme Guide
- set locks and timers
- set subtitles and select a subtitle language
- view your photos or play your favourite music from a USB memory device.

5.1 Remote control

5.1.1 Remote control overview

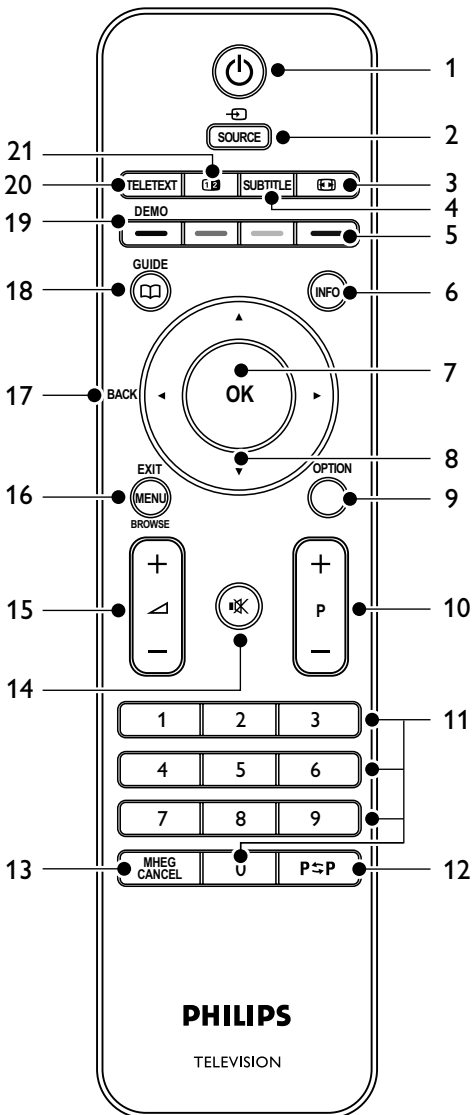

- 1 Standby** To switch the TV on or back to standby.
- 2 Source**
 - To switch the Source menu on or off.
 - To select a connected device or to return to TV.
- 3 Widescreen Picture format** To select a picture format
- 4 Subtitle** To activate or deactivate the subtitle mode.
- 5 Colour keys**
 - Easy selection of teletext pages.
 - Easy selection of tasks.
- 6 Info** To show channel or programme information if available.
- 7 OK**
 - To display the channel list.
 - To activate a setting.
- 8 Navigation key** To navigate (, , ,) or turn left or right to go through lists or settings.
- 9 Option** To switch the Quick access menu on or off.
- 10 +P- Channel up or down** To switch to the next or previous channel in the channel list.
- 11 Number keys** To select a TV channel.
- 12 Previous channel P-S-P** To return to the previously viewed channel
- 13 MHEG Cancel** no function
- 14 Mute** To mute the sound or restore it.
- 15 Volume** To adjust the volume.
- 16 Menu** To switch the menu on or off.

17 Back key

To select the previous programme or the previous TXT page.

To remove the channel list.

18 Guide 

To switch on or off the Electronic Programme Guide.

19 Demo

To switch the Demo menu on and to get a demonstration of the features of the TV.

20 Teletext

To switch teletext on or off.

21 Dual screen 

To show teletext on the right and the picture on the left of the screen.

See section **10 Index** to find the section in the manual about a specific remote control key.

5.2 TV menus

With the on screen menus you install your TV, adjust picture and sound settings and access features. This section gives an overview of the menus and describes how to navigate.

5.2.1 The menu

1 Press **Menu** to show the main menu.

2 Press **Menu** to quit the menu.

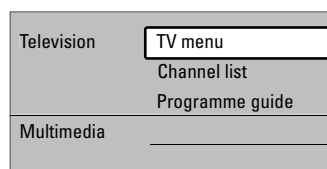
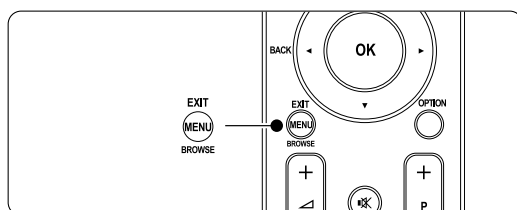

The main menu offers the following items:

- **TV menu**
Select this menu for installation, picture and sound settings and other feature settings.
- **Channel list**
Select this item to show the Channel list. Create your Favourite channel lists here.
- **Programme guide**
Available when digital channels are installed, this item shows information about the digital programmes.
According to the type of Electronic Programme Guide, you can also access the table of scheduled Digital TV programmes and easily select and tune to a desired programme. See section **5.6 Electronic Programme Guide**.
- **Multimedia**
Select this item to view photos or play music stored on a USB device. See section **5.9 View and play photos, MP3, ...**

5.2.2 Use of the menu

Learn to use the menus with this example.

1 Press **Menu**.

The main menu appears on the screen.

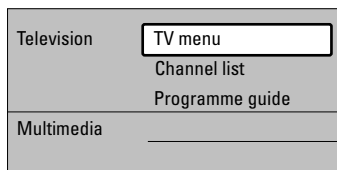

2 Press **▶** to enter the TV menu.

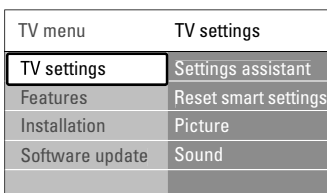

3 Press **▶** to enter the TV settings menu.

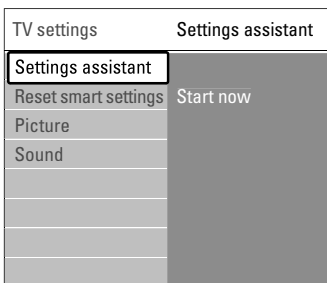

4 Press **▼** to select **Picture**.

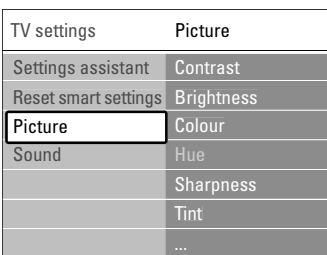

5 Press **▶** to enter the picture settings.

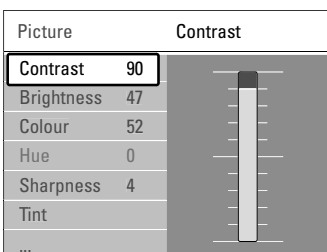

6 Press **▼** to select **Brightness**.

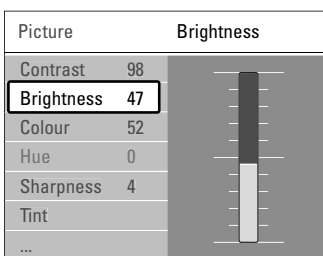

7 Press **▶** to enter the Brightness setting.

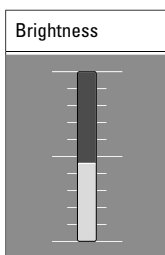

8 Press **▲** or **▼** to adjust the setting.

9 Press **◀** to return to the Picture settings or press **Menu** to quit the menu.

Note:

More choices come available when digital channels are installed and broadcasted.

5.2.3 Quick access menu

The Quick access menu gives direct access to some often needed menu items.

When digital channels are installed and broadcasted the relevant digital options are shown in the menu.

1 Press **Option** on the remote control.

2 Press **▲** or **▼** to select an option.

3 Press **OK** to show the selected option menu.

4 Press **▲**, **▼**, **◀**, **▶** to adjust the settings in the menu.

5 Press **Option** to quit the menu.

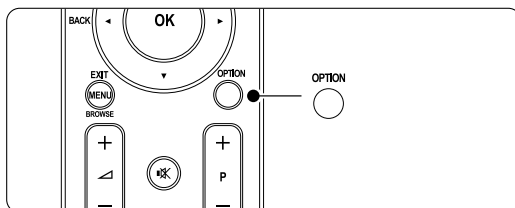

• **Audio language**

See section 5.3.5 Adjust sound settings.

- **Subtitle language**
See section 5.8.3 Select a digital subtitle language.
- **Subtitle**
See section 5.8 Subtitles.
- **Picture format**
See section 5.3.4 Widescreen picture format.
- **Equalizer**
See section 5.3.5 Sound settings.
- **Clock**

Display the clock

- 1 Press **OK** to display the clock permanently.
- 2 Press **Option** and press **▲** or **▼** to select Clock again.
- 3 Press **OK** to hide the clock.

Quick access
Audio language
Subtitle language
Subtitle
Picture format
Equalizer
Clock

5.3 Picture and Sound settings

This section describes how to adjust picture and sound in the menus.

5.3.1 Settings assistant

Use the Settings assistant to guide you through basic picture and sound settings in an easy way.

- 1 Press **Menu** on the remote control and select TV menu > TV settings > **Settings assistant** and press **▶** to enter.
- 2 Press **OK**.
- 3 Press the green key on the remote control to start the assistant.
- 4 Press **◀** or **▶** to select the left or right side to make your choice.
- 5 Press the green key to go to the next setting. You will go through several settings. When finished the TV will ask you to store these settings.
- 6 Press the green key to store all your settings.
- 7 Press **Menu** to quit the menu.

5.3.2 Reset smart settings

Sets the TV to one of the predefined settings. Each setting combines picture and sound.

- 1 Press **Menu** on the remote control and select TV menu > TV settings > **Reset smart settings** and press **▶** to enter the list.
 - 2 Press **▲** or **▼** to select a setting.
 - 3 Press the green key to store your selection.
 - 4 Press **Menu** to quit the menu.
- Standard settings: Current, Standard, Vivid, Movie

5.3.3 Picture settings

This section describes how to adjust all picture settings individually.

- 1 Press **Menu**.
- 2 Select **Picture** and press **▶** to enter the list.
- 3 Press **▲** or **▼** to select a setting.

ⓘ Note:

Not all menu items are available on all models. To verify availability, refer to the product leaflet at www.philips.com/support.

TV settings	Picture
Settings assistant	Contrast
Reset smart settings	Brightness
Picture	Colour
Sound	Hue
	Sharpness
	Tint
	Pixel Plus
	HD Natural Motion
	100Hz Clear LCD
	Dynamic contrast
	Noise reduction
	MPEG artefact red.
	Colour enhanc ...
	Active control
	Light sensor
	Picture format

- **Contrast**
Changes the level of bright parts in the picture but keeps the dark parts unchanged.
- **Brightness**
Changes the level of light of the total picture.
- **Colour**
Changes the level of saturation.
- **Hue**
If NTSC is broadcasted, this level compensates the colour variations.

- **Sharpness**
Changes the level of sharpness of fine details.
- **Tint**
Sets the colours to Normal, Warm (reddish) or Cool (bluish). Select Custom to make a setting of your own in the Custom menu.
 - **Custom**
Press the green key to select each bar to change the value of:
 - R-WP red whitepoint
 - G-WP green whitepoint
 - B-WP blue whitepoint
 - R-BL red blacklevel
 - G-BL green blacklevel
- **Pixel Plus**
Controls the advanced settings of the Pixel Plus Engine, resulting in best sharpness, contrast, colour and motion.
- **HD Natural Motion** (if present)
Removes motion judder and reproduces smooth movement especially in movies.
- **100 Hz Clear LCD** (if present)
Gives a superior motion sharpness, better black level, high contrast with a flicker-free, quiet image and a larger viewing angle.
- **Dynamic contrast**
Sets the level at which the TV automatically enhances the details in dark, middle and light areas of the picture.
- **Noise reduction**
Filters out and reduces the noise in the picture. Set the level to Minimum, Medium, Maximum or Off.
- **MPEG artefact reduction**
Smooths the digital transitions in the picture.
- **Colour enhancement**
Makes the colours more vivid and improves the resolution of details in bright colours
- **Active control**
Corrects all incoming signals in order to provide the best picture possible.
Switches Active control on or off.
- **Light sensor**
Adjusts the picture settings on the lighting conditions of the room. Switches Light sensor on or off.
- **Picture format / Auto format mode**
See section 5.3.4 Widescreen picture format.

5.3.4 Widescreen picture format

Avoid black bars on the sides or on top and bottom of the picture. Change the picture format to a format that fills the screen.

- 1 Press **Menu** on the remote control and select TV menu > TV settings > Picture > **Picture format** and press **▶** to enter the list.
- 2 Press **▲** or **▼** to select an available picture format.

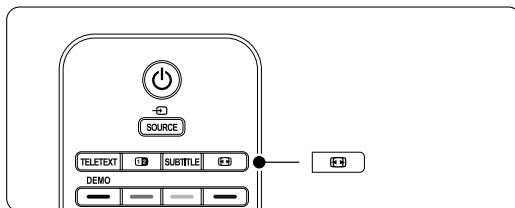

- 3 Press **▲** to shift the picture upwards to make partly covered subtitles visible.

Tip

The Auto format setting is recommended for minimal distortion .

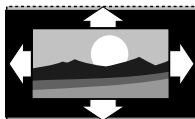

Auto format (Not for PC.)

Enlarges the picture automatically to fill the screen. Subtitles remain visible.

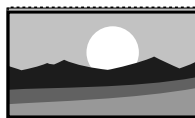

Super zoom (Not for HD.)

Removes the black bars on the side of 4:3 broadcasts. There is a minimal distortion.



4:3 (Not for HD.)

Shows the classical 4:3 format.



Movie expand 14:9

(Not for HD.)
Scales classical 4:3 format to 14:9.

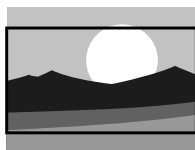

Movie expand 16:9

(Not for HD.)
Scales classical 4:3 format to 16:9.



Wide screen

Stretches 4:3 format to 16:9.

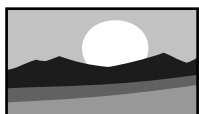

Unscaled

(Only for HD and PC.)

Maximum sharpness.

Distortion may appear on borders. Black bars may appear with pictures from your PC.

Note

Do not forget to name the connection in the Connection menu. See section **7.4.1 Assign devices to connectors**.

5.3.5 Sound settings

This section describes how to adjust all sound settings.

- 1 Press **Menu** on the remote control and select TV menu > TV settings > **Sound** and press ► to enter the list.
- 2 Press ▲ or ▼ to select a setting.

TV settings	Sound
Settings assistant	Equalizer
Reset smart settings	Volume
Picture	Balance
Sound	Audio language
	Dual I/II
	Mono/Stereo
	Surround mode
	Headphone volume
	Auto volume level...
	Delta volume
	Auto surround

• Equalizer

Changes the bass and treble of the sound. Select each bar to change the setting. See also section **5.2.3 Quick access menu**.

• Volume

Changes the volume.

When adjusting the volume with  a volume bar appears. If you don't want it to appear go to TV menu > Installation > **Preferences** and press ► to enter the list and select Volume bar off.

- 1 Press ▲ or ▼ to select **Volume bar**.
- 2 Press ► to enter.
- 3 Select **On** to activate the temporarily display of the volume bar when adjusting the volume.

• Balance

Sets the balance of the left and right loudspeakers to fit best your listening position.

• Audio language

A list of audio languages for the current programme may be available when digital channels are installed and broadcasted.

See also section **5.2.3 Quick access menu**.

To permanently change the audio language, see section **6 Channel installation**.

• Dual I/II

If broadcasted, you can choose between two different languages.

• Mono/stereo

If stereo broadcasting is available, you can select Mono or Stereo per TV channel.

• Surround mode

To select a more spatial sound if broadcasted or if available from a connected device.

• Headphone volume

Changes the volume of the headphone.

You can mute the TV speakers with  on the remote control.

• Automatic volume leveller

Reduces sudden volume differences like at the beginning of commercials or when switching from one channel to another.

Select on or off.

• Delta volume

Levels out volume differences between channels or connected devices.

- 1 Switch to the channel or device you want to level out the volume difference.
- 2 Select **Delta volume** in the Sound menu and change the volume level.

• Auto surround

Switches the TV automatically to the best surround sound mode broadcasted.

Select on or off.

5.4 Teletext

Your TV has a 1200 pages memory that stores broadcasted teletext pages and subpages to reduce waiting time.

To select a teletext page see section 4.6 Select a Teletext page.

5.4.1 Select a teletext language

Some digital TV broadcasters offer the possibility to select your preferred teletext language. See section 6.1 Automatic installation.

5.4.2 Select paganumber subpages

A teletext page number can hold several subpages. The pages are shown on a bar next to the main paganumber.

- 1 Press **Teletext**.
- 2 Select a teletext page.
- 3 Press **◀** or **▶** to select a subpage.

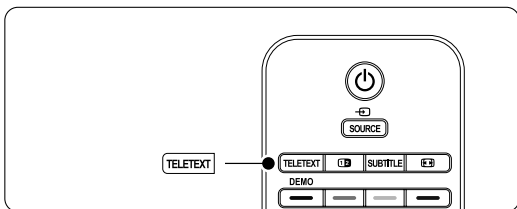

5.4.3 Select T.O.P. teletext broadcasts

T.O.P. teletext (Table of Pages) is not broadcast by all TV channels. You can easily jump from one subject to another without using paganumbers.

- 1 Press **Teletext**.
- 2 Press **Info**.
The T.O.P. overview appears.
- 3 Use **◀** or **▶**, **▲** or **▼** to select a subject.
- 4 Press **OK** to view the page.

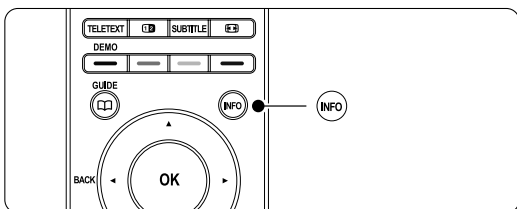

5.4.4 Dual screen teletext

View the TV channel and teletext next to each other.

- 1 Press **12** for Dual screen teletext.
- 2 Press **Teletext** again to show normal teletext.
- 3 Press **Teletext** to switch off teletext.

5.4.5 Search teletext

Quickly jump to a subject linked to a series of paganumbers or search for specific words in teletext pages.

- 1 Press **Teletext**.
- 2 Press **OK** to highlight the first word or number.
- 3 Press **◀** or **▶**, **▲** or **▼** to jump to the next word or number on the page.
- 4 Press **OK** to search a page which holds the highlighted word or number.
- 5 Press **▲** until no word or number is highlighted to quit Search.

5.4.6 Enlarge teletext pages

For a more comfortable reading, you can enlarge the teletext page.

- 1 Press **Teletext** and select a teletext page.
- 2 Press **Option** to enlarge the top part of the page.
- 3 Press **Option** again to view the enlarged lower part of the page.
- 4 Press **▲** or **▼** to scroll through the enlarged page.
- 5 Press **Option** again to return to the normal page size.

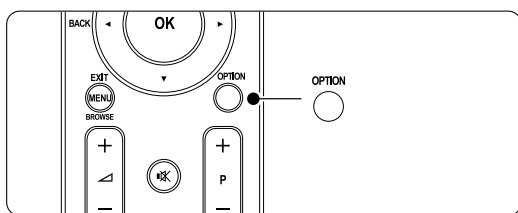

5.4.7 Teletext menu

With the options in the teletext menu you can reveal hidden info, let cycle subpages automatically and change the character setting.

- **Reveal**
Hide or unhide hidden information on a page, such as solutions to riddles or puzzles.
- **Cycle subpages**
If subpages are available for the selected page, you can make subpages cycle automatically.

- **Language**

Some languages use a different set of characters. Switch to the other group to show the text correctly.

- 1 Press **Teletext**.
- 2 Press **Menu**.

Teletext menu	
Reveal	Off
Cycle subpages	Off
Language	Gr. II

- 3 Press **▲** or **▼** to select an option.
- 4 Press **OK** to change a setting.
- 5 Press **Menu** to quit the teletext menu.
- 6 Press **Teletext** to switch off teletext.

5.4.8 Teletext 2.5

If broadcasted by the TV channel this teletext offers more colours and better graphics.

Teletext 2.5 is switched on as a factory setting.

- 1 Press **Menu** on the remote control and select Setup > Installation > Preferences > **Teletext 2.5** and press **▶** to enter the list.
- 2 Select on or off.

5.5 Create favourite channel lists

View the All channels list or set up a Favourite list of your own with your preferred TV channels and radio stations.

5.5.1 Select a favourite list

You can select one of the favourite channel lists.

- 1 Press **OK**.
The first time after you have finished the installation, the All channels list is shown. In other situations, it brings up the last selected favourite list.

All channels	
....	
EXT 3	
HDMI ...	
1 Analogue channel 1	
2 Digital channel 1	
3 Digital channel 2	
4 Radio channel 1	
....	
<input checked="" type="radio"/> Select list	<input type="radio"/>

- 2 Press the red key to show all favourite lists.
- 3 Press **▲** or **▼** to select a list.
- 4 Press **OK**.
The selected favourite list appears.
- 5 Press **OK** again to quit.

5.5.2 To set up a favourite list

Create or modify your own favourite list.

- 1 Press **OK**.
The last selected list appears.
- 2 Press the red key to show all favourite lists.
- 3 Press **▲** or **▼** to select a list.
- 4 Press **OK**.
- 5 Press the green key to enter the Edit mode.
The selected list brings up a full channel list.
- 6 Press **▲** or **▼** to highlight a channel.
- 7 Press **OK** to mark (or unmark) the highlighted channel. The channel is added to (or removed from) the selected list.
- 8 Press the green key again to leave the Edit mode.
The modified channel list appears again.

5.5.3 Select a channel from a favourite list

- 1 Press **OK**.
The last selected channel list appears.
- 2 Use **▲** or **▼** to highlight a channel.
- 3 Press **OK**.
The TV tunes to that channel.

Tip

- Use **-P+** to go through the TV channels of the selected favourite list.
- With the number keys you can still select channels which are not marked as favourite.

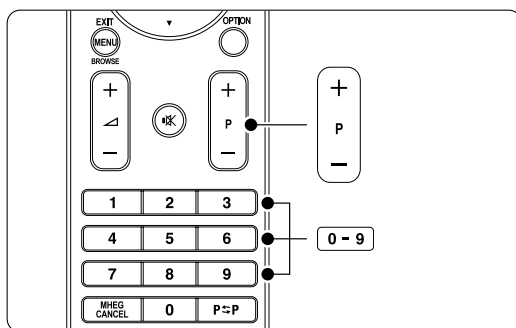

5.6 Electronic Programme Guide - EPG -

The Electronic Programme guide is an on screen guide to scheduled digital TV programmes. You can navigate, select and view programmes by time, title or genre. There are two types of EPG, 'Now and Next' and '7 or 8 day' EPG.

When digital channels are installed and broadcasted, EPG is available. 'Now and Next' is always available but the '7 or 8 day' EPG is only available in some countries.

With the EPG menu you can...

- see a list of current broadcasted programmes
- see the next programme
- group programmes by genre
- set reminders when programmes will start
- set up preferred EPG channels
- etc.

5.6.1 Switch on EPG

1 Press . The following type of EPG appears:

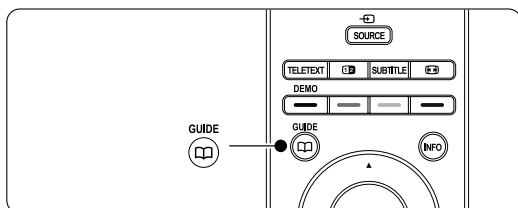

'Now and Next' EPG

Detailed information about the current programme is shown.

26 BBC1	Tue., 12 Sep	09:17
Title : Commonwealth Games		
Info: 7:50 - 12:30 : 280 min		
Exit	Next	
Press -P+ to change channel.		

Or

'7 or 8 day' EPG

It may take some time to receive the EPG data. The list of TV programmes will show.

Programme guide				Tue., 12 Sep
	Around	09:55	Next	
BBC ONE	07:50 Commonwealth	12:30	Commonwealth	
BBC TWO	09:50 Tweenies	10:15	Something Special	
five	09:00 The Wright Stuff	10:30	Trisha Goddard	
BBC THREE	05:32 This is BBC THREE	12:00	This is BBC THREE	
BBC FOUR	05:32 This is BBC FOUR	12:00	This is BBC FOUR	
abc1	09:20 Moonlighting	10:15	Daddio	
Remind 13:50 Anastasia Watch Jump to ... 0010 - EEN Info				

- Use the colour keys to activate the available actions at the bottom of the screen.
 - **Next:** to show information about the next programme.
 - **Remind:** to mark or unmark a programme as a reminder.
 - **Watch:** to watch or listen to a current programme.
 - **Jump to...:** to jump to the next or previous day.
 - **Info:** to display information on a selected programme (if available).
- Press to quit the EPG.

5.6.2 More on '7 or 8 day' EPG

Search by genre, scheduled reminders, etc. are managed in the Programme guide menu.

1 Press on the remote control.

2 Press **Menu**.

The Programme guide menu appears.

Programme guide	What's on
What's on	12:30 South Today
Search by genre	11:50 Working Lunch
Scheduled remind...	11:55 Melrose Place
Preferred EPG ch...	13:00 In aller Freund
Acquire EPG data	

- Press or to select a menu option.
- Press to enter.
- Press or to make a selection.
- Press **OK** to activate or press the green key to watch
- Press to quit the EPG.

Note

Only channels marked as Preferred EPG channels appear in the Programme guide menu

5.7 Timers and locks

This section describes how to switch the TV on or off at a specified time and to lock or unlock the TV.

5.7.1 Automatically switch to standby

Sleeptimer switches the TV to standby after a time.

- 1** Press **Menu** on the remote control and select **Features > Sleeptimer** and press **▶** to enter the sleeptimer bar.
- 2** Press **▲** or **▼** to set the time up to 180 minutes in steps of 5 minutes. If set to 0 minutes, the Sleeptimer is switched off.

You can always switch off your TV earlier or reset the time during countdown.

5.7.2 Automatically switch the TV on

On timer switches the TV on automatically to a specified channel at a specified time, from standby.

- 1** Press **Menu** on the remote control and select **Features > On timer** and press **▶** to enter the On timer menu.
- 2** Use **◀** or **▶**, **▲** or **▼** to select and enter the menu items one by one to set a channel, a day of the week or daily, and a starting time.
- 3** Press **OK** to confirm.
- 4** Press **Menu** to quit the menu.

⊕ Tip

To switch off the On timer, select **Off** in the On timer menu.

5.7.3 Lock TV channels and programmes

Lock TV channels and/or programmes from connected devices to prevent children from watching them. Lock and unlock with a four number code.

Set or change your code

- 1** Press **Menu** on the remote control and select **Features > Set or Change code** and press **▶** to enter your code.
- 2** Enter your code with the number keys.
The **Features** menu reappears with a message confirming that your code has been created or changed.

Did you forget your code ?

- 1** Select **Change code**.
- 2** Press **▶**.

- 3** Enter the overriding code 8-8-8-8.

- 4** Enter a new personal code.

- 5** Confirm your new entered code.

The previous code is erased and the new code is stored.

5.7.4 Activate or deactivate Child lock

Set your code and you can:

- Lock all channels and devices,
- Lock specific channels and devices,
- Set a time after which all channels and devices are locked,
- Set the maximum allowed parental rating for digital channels that are installed and broadcast.

- 1** Press **Menu**.
- 2** Select **Features > Child lock** and press **▶**.
- 3** Enter your code with the number keys.
- 4** Select one of the options.
- 5** Press **▶**.

Lock or unlock all channels and connected devices

- 1** Select **Lock** or **Unlock**.

Lock a certain programme or all channels from a certain time

Child lock	Custom lock
Lock	Lock after
Custom lock	Channel lock
Unlock	Parental rating

- 1** Select **Custom lock**.
- 2** Press **▶** to enter the Custom lock menu.
- 3** Press **▶** again to enter the Lock after menu.
- 4** Select **On** to switch on the Timer lock.
- 5** Press **◀**.
- 6** Select **Time**.
- 7** Press **▶**.
- 8** Enter the time with **▲** or **▼** and **▶**.
- 9** Press **OK**.

Lock one or more channels and connected devices

- 1** Select **Custom lock**.
- 2** Press **▶** to enter:
- 3** Press **▲** or **▼** to select **Channel lock**.
- 4** Press **▶**.
- 5** Press **▲** or **▼** to select the channel(s) you want to lock or unlock.
- 6** Each time press **OK** to lock or unlock the channel.

Set an age rating to a digital programme

Some digital broadcasters have their programmes rated (depending on your country). When the rating is higher than your child's age, the programme will be locked.

- 1 Select **Custom lock**.
- 2 Press **▶** to enter.
- 3 Press **▲** or **▼** to select **Parental rating**.
- 4 Press **▶**.
- 5 Press **▲** or **▼** to select an age rating.
- 6 Press **Menu** to quit the Child lock menu.

5.8 Subtitles

For each TV channel, subtitles can be set, coming from Teletext or DVB-T (digital) broadcasts. If digital channels are installed and broadcasted, you can select your preferred subtitle language.

5.8.1 Subtitling from analogue TV channels

- 1 Select an analogue TV channel.
- 2 Press **Teletext** to switch on Teletext.
- 3 Enter the three number pagenummer of the subtitle page.
- 4 Press **Teletext** to switch off Teletext.

Note

The Teletext subtitle page of analogue channels must be stored for each TV channel separately.

5.8.2 Activate or deactivate subtitling

- 1 Press **Menu** on the remote control and select **Features > Subtitle** and press **▶** to enter the list.
- 2 Press **▲** or **▼** to select **On** to show the subtitles always or **On during mute** to show the subtitles only when the sound is muted with the  key on the remote control.
- 3 Press **◀** to return to the Features menu.

TV menu	Features
TV settings	Subtitle
Features	Subtitle language
Installation	Sleeptimer
Software update	Child lock
	Set/Change code
	On timer
	Demo

5.8.3 Select a digital subtitle language

If subtitle broadcasting is available with digital channels, you can select a preferred subtitle language out of a list of broadcasted languages. The preferred subtitle languages set in the Installation menu are overruled temporarily.

- 1 Press **Menu** on the remote control and select **Features > Subtitle language** and press **▶** to enter the list of available languages.
- 2 Press **▲** or **▼** to select a subtitle language.
- 3 Press **OK**.

5.9 View and play: photos, MP3, ...

Watch pictures or listen to music stored on a USB device (not supplied with the TV). Watch your pictures as a slideshow or listen to a self made music playlist.

Note

Philips can not be held responsible if your USB device is not supported nor shall Philips accept any liability for damage or loss of stored data. See section **8 Technical data** for the playback formats supported.

5.9.1 Insert a USB device

Insert a device at the side of the TV while the TV is switched on.

The main menu appears automatically and the

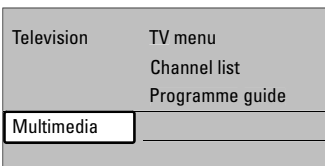

name of the USB device is highlighted next to **Multimedia**.

5.9.2 Remove the USB device

Caution

To avoid damaging the USB device always quit the menu on screen and wait five seconds before you remove the USB device.

- 1 Press **Menu** to quit the menu.
- 2 Remove the USB device.

5.9.3 View your pictures

The Multimedia menu shows the files you have stored on your USB device.

USB	Picture
Picture	Afrika_2001
Music	Paris_2006
	My_car.jpg
	Jean.jpg
	Mary.jpg

- 1 Press **▶** to enter the Multimedia menu. **Picture** is highlighted.
- 2 Press **▶** to enter the Picture folder.
- 3 Press **▲** or **▼** to select a picture or a picture

Picture	Afrika_2001
Afrika_2001	Kenya.jpg
Paris_2005	Congo.jpg
My_car.jpg	Victoria.jpg
Jean.jpg	Dakar.jpg
Mary.jpg	Cairo.jpg

Afrika_2001	Afrika_2001
Kenya.jpg	 Kenya.jpg
Congo.jpg	
Victoria.jpg	
Dakar.jpg	
Cairo.jpg	

album on the USB device.

- 4 Press **OK** to view the picture or to start a slideshow of the pictures in the album.
- 5 Press **OK** to pause the slideshow. Press again to restart.
- 6 Press one of the colour keys on the remote control to perform the corresponding function shown at the bottom of the screen. Press the blue key to stop the show and to see more functions. If the function bar at the bottom disappeared, press any colour key to let it reappear.
- 7 Press **◀** and select another picture or another album.

Slideshow settings

Details / More details

Shows the picture name, date, size and next picture in the slideshow.

Transitions

Shows the list of available transition styles of the pictures.

Press navigation key up or down to select and press **OK** to activate.

Slide time

Sets the time lag for the picture transitions: Short, Medium or Long.

Rotate

To rotate a picture.

Zoom

Show a list of available zoom magnifications to select.

Start/Show

To stop and restart the slideshow.

5.9.4 Thumbnails

View the pictures of a selected album in an overview.

- 1** Select a picture album.
- 2** Press **▶** to enter the picture list.
- 3** Press the green key.
- 4** Press **▲**, **▼**, **◀**, **▶** to highlight a picture.
- 5** Press **OK** to view the picture.
- 6** Press **◀** to return to the thumbnail overview.

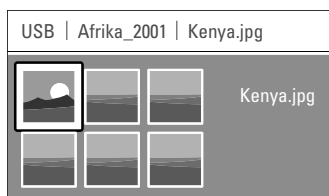

- 7** Press the green key again to go back to the picture list.

Listen to music

Find your songs in the Music album of the Multimedia menu.

- 1** Highlight **Music** in the Multimedia menu.
- 2** Press **▶** to enter the Music folder.
- 3** Press **▲** or **▼** to select a song or a music album.
- 4** Press **OK** to play the selected song or to play a song followed by the next song in the same album.

Music settings

- **Details**
Shows the file name.
- **Repeat one/all**
Repeat all songs in the album until you stop a song or only repeat the one song selected until you stop the song.
- **Shuffle**
Play songs in a random sequence.

Slideshow with background music

Watch a slideshow of your stored pictures accompanied with your stored background music.

- 1** Select an album of songs first and press **OK**.
- 2** Highlight the Picture folder and select an album of pictures and press **OK**.

5.10 Listen to digital radio channels

If digital broadcasting is available, digital radio channels are installed during installation.

To listen to a digital radio channel:

- 1** Press **OK** on the remote control.
The **All channels** menu is displayed.
- 2** Use the number keys to select a radio channel available from channel number 400 onwards.
To reorder see section **6.3.3 Reorder the channels**.
- 3** Press **OK**.

5.11 Software update

Philips continuously tries to improve its products. It may be recommended for you to update the TV's software. To update your TV software you need a USB Memory device (not supplied).

Note

The device must have at least 48Mb free space. Make sure the write protection is turned off. Some USB devices do not work with our TV. Contact your dealer.

5.11.1 Update assistant

The Update assistant helps you to update the TV's software.

TV identification

The TV will identify itself to your USB memory device.

- 1 Switch the TV on.
- 2 Press **Menu**.
- 3 Press **▶**.
- 4 Press **▲** or **▼** to select **Software update**.
- 5 Press **▶**.
- 6 Press **▲** or **▼** to select **Update assistant**.

TV menu	Software update
TV settings	Current software...
Features	Update assistant
Installation	Local updates
Software update	Announcement

- 7 Press **▶**.
- 8 Press **OK** to activate.
- 9 Insert a USB memory device to the USB connector at the side of the TV. The main menu appears.
- 10 Press the green key to proceed. A message appears the TV has successfully written the identification file to the USB memory device.
- 11 Press the green key again to finish.
- 12 Remove the USB memory device from the TV.

5.11.2 Software download from the PC to the USB device

- 1 Insert the USB memory device into a PC linked to the internet.
- 2 Locate and open the file "update.htm" on your USB device.
- 3 Read the instructions on screen and click on the **Send ID** button. The software update is downloaded on the USB memory device.
- 4 Remove the USB memory device from your PC.

5.11.3 Transfer of the downloaded software update to the TV

The downloaded software on the USB memory device must now be uploaded to your TV.

Caution

- Do not remove the USB memory device during the software update.
- If a power drop occurs during the update, do not remove the USB memory device from the TV. The TV will continue the update as soon as the power comes back.

- 1 Insert the USB memory device to the USB connector at the side of the TV.

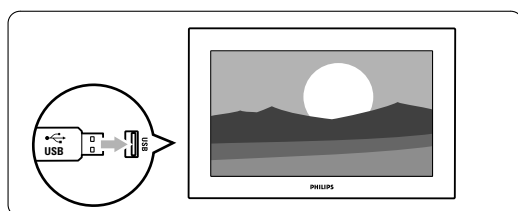

- 2 The TV switches off. The screen stays black for about 10 seconds. Wait and do not use the power switch  on the TV.

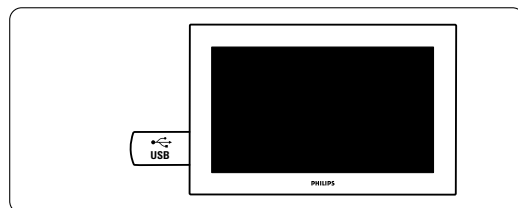

- 3** The update process starts automatically. Please wait.

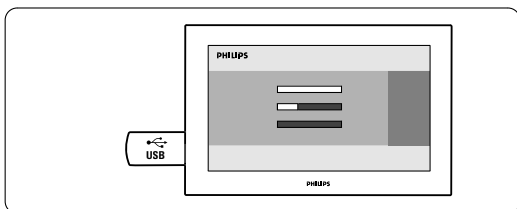

The update is finished when the message 'Operation successful' appears on the screen.

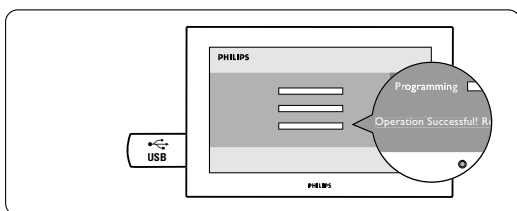

- 4** Remove the USB memory device from the TV.

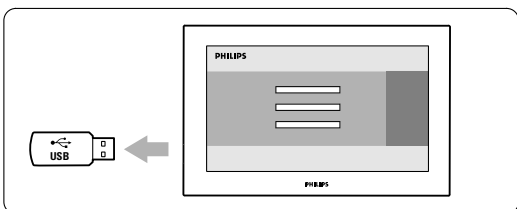

- 5** Press  on the remote control.

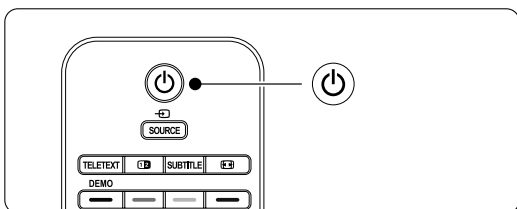

Note

Do not press more than once and do not use the Power  switch on the TV.

- 6** The TV switches off. The screen stays black for about 10 seconds. Please, wait.

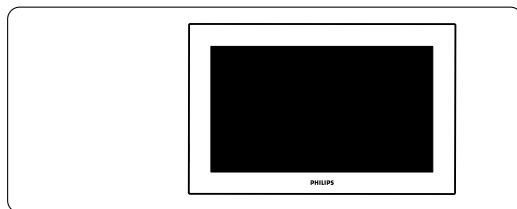

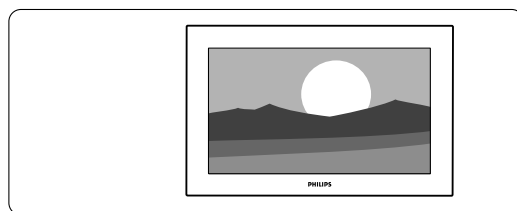

- 7** The TV switches back on again. The update is done.



5.11.4 Verify the current software version

Updating software is only possible if the version of the new available software is different from the current one. You can verify your current software version.

- 1** Select **Software update** in the TV menu.
- 2** Press .
- 3** Press  or  to select **Current software info**. The version and the description of the current software appears.

5.11.5 Software update by digital broadcast (DVB-T)

Your TV might receive new software from the digital broadcast system automatically.

If you receive an update message on screen it is strongly advised to update the software immediately - select **Now**.

Select **Later**, if you want to be reminded later on.

Select **Cancel** to quit the update (not recommended). If you cancelled the update you can still update yourself from the TV menu > Software update > Local update.

6 Channel installation

The first time you switched on your TV you've selected the language of the TV menus and all the available channels have been installed.

This chapter will help you if you find it necessary to re-do the initial installation or if you want to tune in a new analogue TV channel.

ⓘ Notes:

- You do not have to follow every step described if it is not necessary.
- Re-installation will modify the All channels list and new added channels will not be added to any favourite list.

6.1 Automatic installation

This section describes how to search for and store all available channels automatically.

Step 1 Menu language

Sets the language of the TV menus.

Go to a next step if your language settings are correct.

- 1** Press **Menu** on the remote control and select TV menu > Installation > **Languages** and press **▶** to enter **Menu language**.
- 2** Press **▲** or **▼** to select your language.
- 3** Press **OK** to confirm.
- 4** Press **◀** to return to the Installation menu.

Installation	Languages
Languages	Menu language
Time zone	Preferred audio
Channel install...	Preferred subtitles
Preferences	Hearing impaired
Connections	
Factory settings	

The Languages menu also offers the following language settings when digital channels are installed and broadcasted.

- **Preferred audio**

Select one of the available audio languages as preferred language.

- **Preferred subtitles**

Select one of the available subtitle languages as preferred language. See section **5.8 Subtitles**.

- **Hearing impaired**

Select **On** to display the hearing impaired subtitle version of your preferred audio or subtitle language when available.

Step 2 Time zone selection

- 1** Press **▼** to select **Time zone**.
- 2** Press **▶** to enter the list.

Installation	Time zone
Languages	New South Wales...
Time zone	Victoria
Channel install...	Queensland
Preferences	South Australia
Connections	Western Australia
Factory settings	Tasmania
	Northern Territory

- 3** Press **▲** or **▼** to select your time zone.
- 4** Press **◀** to return to the Installation menu.

Step 3 Install TV and radio channels

Your TV will search for and store all available digital and non-digital TV channels and all available digital radio channels.

- 1** Press **▼** to select **Channel installation**.
- 2** Press **▶** to enter the Channel installation menu. **Automatic installation** is highlighted.
- 3** Press **▶** to select **Start now**.
- 4** Press **OK**.
- 5** Press the green key to start. The installation may take a few minutes.
- 6** When the channel search is completed, press the red key to return to the Installation menu.
- 7** Press **Menu** to quit the TV menu.

ⓘ Tip

When digital TV channels are found, the list of installed channels may show some empty channel numbers.

If you want to rename, reorder or uninstall stored channels, see section **6.3 Rearrange channels**.

6.2 Analogue: Manual installation

You can tune-in analogue TV channels channel by channel manually with Manual installation.

6.2.1 Select the system

- 1 Press **Menu** on the remote control and select TV menu > Installation > Channel installation > **Analogue: Manual installation**.
- 2 Press **▶** to enter the Manual installation menu. **System** is highlighted.
- 3 Press **▶** to enter the System list.
- 4 Press **▲** or **▼** to select your TV system: PAL BG 5.5 MHz, PAL I 6.0 MHz, PAL DK 6.5 MHz or NTSC M 4.5 MHz.
- 5 Press **◀** to return to the Manual installation menu.

Channel install...	Analogue: Manual...
Automatic install...	System
Installation update	Search
Digital: Test recept...	Fine tune
Analogue: Manual...	Store current ch...
Rearrange	Store as new ch...

6.2.2 Search for and store a new channel

- 1 Press **Menu** on the remote control and select TV menu > Installation > Channel installation > Analogue: manual installation > **Search**.
- 2 Press **▶** to enter the Search menu.
- 3 Press the red key to enter the frequency yourself or press the green key to search for a next channel.

Tip

If you know the frequency, enter the three numbers of the frequency with the number keys of the remote control.

- 4 Press **◀** when the new channel has been found.
- 5 Select **Store as new channel** to store the new channel under a new channel number.
- 6 Press **▶** to enter.
- 7 Press **OK**. **Done** appears.
- 8 Press **Menu** to quit the channel installation menu.

6.2.3 Fine tune a channel

Fine tune a found channel when the reception is poor:

- 1 Press **Menu** on the remote control and select TV menu > Installation > Channel installation > Analogue: manual installation > **Fine tune**.
- 2 Press **▶** to enter the Fine tune menu.
- 3 Press **▲** or **▼** to adjust the frequency
- 4 Press **◀** when you finished fine tuning.
- 5 Select **Store current channel** to store the fine tuned channel under the current channel number.
- 6 Press **▶** to enter.
- 7 Press **OK**. **Done** appears.
- 8 Press **Menu** to quit the Channel installation menu.

6.3 Rearrange stored channels

To rename, reorder, uninstall or reinstall stored channels.

6.3.1 Rename a channel

Assign or change a channel name to a channel for which a name has not yet been entered.

- 1 Press **Menu** on the remote control and select TV menu > Installation > Channel installation > **Rearrange**.
- 2 Press **▶** to enter the channel list.
- 3 Press **▲** or **▼** in the channel list to select the channel you want to rename.
- 4 Press the red key.
- 5 Press navigation key **◀** or **▶** to select a character or **▲** or **▼** to change the characters. Space, numbers and other special characters are located between **z** and **A**.
- 6 Press the green key or **OK** to finish.

Tip

With the yellow key all characters can be deleted. With the blue key you can delete the character which is highlighted.

6.3.2 Uninstall or reinstall a channel

To uninstall a stored channel so that it is no longer possible to tune to.

Reinstall an earlier uninstalled channel.

- 1** Press **Menu** on the remote control and select TV menu > Installation > Channel installation > **Rearrange**.
- 2** Press **▶** to enter the channel list.
- 3** Press **▲** or **▶** in the channel list to select the channel you want to uninstall or reinstall.
- 4** Press the green key to uninstall or reinstall the channel.
- 5** Press **Menu** to quit the menu.

6.3.3 Reorder the channels

Change the order of the stored channels.

- 1** Press **Menu** on the remote control and select TV menu > Installation > Channel installation > **Rearrange**.
- 2** Press **▶** to enter the channel list.
- 3** Press **▲** or **▼** in the channel list to select the channel you want to reorder.
- 4** Press the yellow key to move up the highlighted channel in your channel list.
- 5** Press the blue key to move down the highlighted channel in your channel list.
- 6** Press **Menu** to quit the menu.

6.4 Automatic channel management

Once a day, at 5 AM, all available TV channels are updated automatically. The update is done if your TV is in standby.

Earlier stored channels not found by the update will be removed from the channel list.

You can do this update yourself anytime.

- 1** Press **Menu** on the remote control and select TV menu > Installation > Channel installation > **Installation update**.
- 2** Press **▶** to enter the Installation update menu.
- 3** Press **OK**.
- 4** Press the green key to start.
The update starts and may take a few minutes.
- 5** When the update is completed, press the red key to return to the Channel installation menu.
- 6** Press **Menu** to quit the menu.

6.5 Digital reception test

If you receive Digital TV broadcasting you can check the quality and signal strength of a specific channel.

- 1** Select a channel.
- 2** Press **Menu** on the remote control and select TV menu > Installation > Channel installation > **Digital: Test reception**.
- 3** Press **▶** to enter
- 4** Press **OK**.
The channel frequency, the network name, the signal quality and strength appear.
- 5** Press the green key to start or directly enter the frequency of the channel you want to test.
If the signal quality and strength are poor, reposition the antenna.
- 6** Press the yellow key to store the frequency if the signal quality and strength are good.
- 7** Press the red key to return to the Channel installation menu.
- 8** Press **Menu** to quit the menu.

Tip

To achieve the best results, contact a specialised antenna installer.

6.6 Factory settings

If you are lost in the picture and sound settings, you can reset the TV to the factory settings of picture and sound.

- 1** Press **Menu** on the remote control and select TV menu > Installation > **Factory settings**.
- 2** Press **▶** to enter the Factory settings menu.
- 3** Press **OK**.
- 4** Press **Menu** to quit the menu.

Note

The channel installation settings are not changed.

7 Connections

7.1 Connection overview

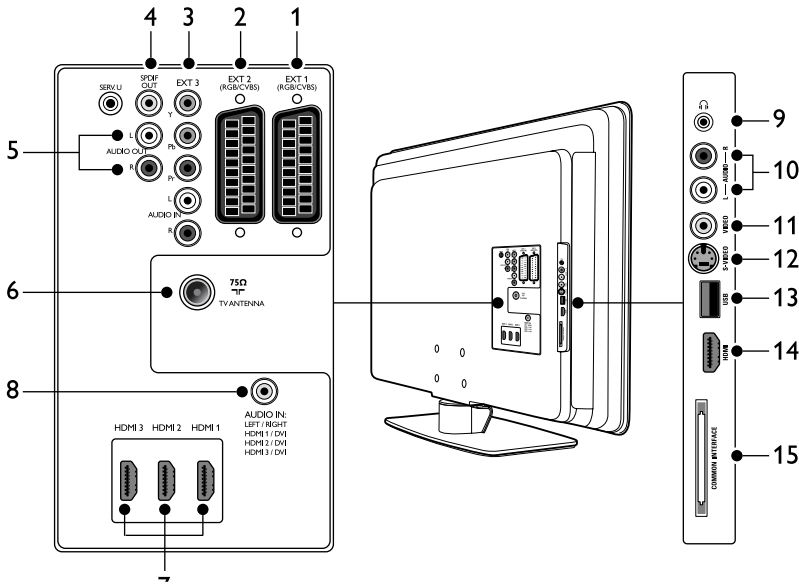

Back connectors

- EXT 1**
First SCART connector for DVD players, VCRs, digital receivers, game consoles and other SCART devices. Supports Audio L/R, CVBS in/out, RGB.
- EXT 2**
Second SCART connector. Supports Audio L/R, CVBS in/out, RGB.
- EXT 3**
Component video (Y Pb Pr) and Audio L/R input connectors for DVD players, digital receivers, game consoles and other component video devices.
- SPDIF OUT**
SPDIF sound output connector for home theatres and other audio systems.
- AUDIO OUT L/R**
Sound output cinch connectors for home theatres or other audio systems.
- TV ANTENNA**
- HDMI 1/2/3**
HDMI input connectors for Blu-ray Disc players, digital receivers, game consoles and other high-definition devices.

Note

The number of HDMI connectors available may vary according to your TV model.

8 AUDIO IN

Mini-jack connector for PC audio in (when connecting a PC via a DVI-HDMI adaptor).

Side connectors

- Headphones**
Stereo mini-jack.
- AUDIO L/R**
Audio L/R input connectors for composite and S-Video devices.
- VIDEO**
Video input cinch connector for composite devices.
- S-VIDEO**
S-Video input connector for S-Video devices.
- USB**
USB connector for storage devices.
- HDMI**
Additional HDMI connector for mobile high-definition devices.
- COMMON INTERFACE**
Slot for Conditional Access Modules. Not currently supported by service providers in Australia.

7.2 About connections

7.2.1 What you need to know

Connect your device with the highest possible quality connection.

Look for the highest quality connection on your device. Use that connection to your TV.

HDMI - Highest quality ★★★★★

An HDMI connection has the best picture and sound quality. One cable combines video and audio signals. Use HDMI for HD (High Definition) TV signals. HDMI with EasyLink offers easy operating of your connected devices when these have the HDMI CEC standard. See section 7.2.2 EasyLink. A device connected with HDMI to the TV can only send out audio and video signals to your TV. The device cannot receive or record audio and video from your TV.

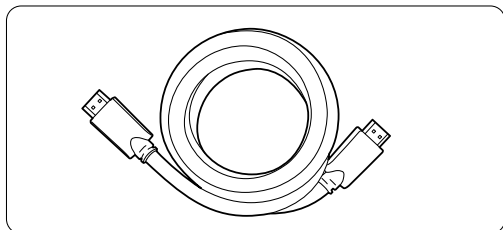

HDMI cable (max. 5m)

Tip

DVI to HDMI – Higher quality ★★★★★

Use a DVI to HDMI adaptor if your device has only a DVI connection.

Connect an Audio L/R cable to Audio In (HDMI to DVI) for sound.

You need to assign this Audio In (HDMI to DVI) connector to the HDMI 1, 2 or 3 connector you are using for this device. See section 7.4.2 Audio setup.

Note

HDMI supports HDCP (High-bandwidth Digital Contents Protection). HDCP is a copy protection signal that comes with HD content (DVD disc or Blu-ray Disc).

YPbPr – Higher quality ★★★★★

Use the Component Video YPbPr connections together with Audio Left and Right. Match the cable colours when you connect.

YPbPr can handle HD TV signals.

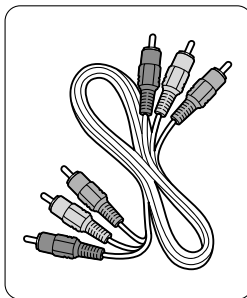

Component Video YPbPr cable
- Red, Green, Blue

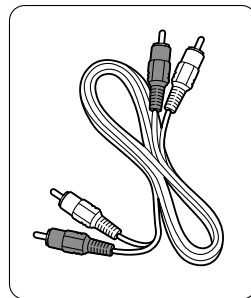

Audio L/R cable
- Red, White

Scart - Good quality ★★★

One cable combines video and audio signals.

Scart connectors can handle RGB video but no HD TV signals.

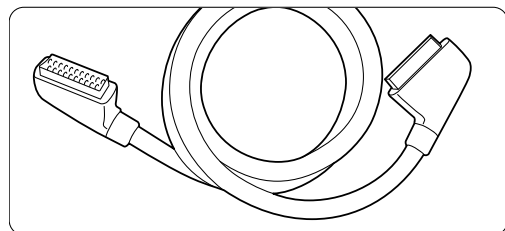

Scart cable

Use the supplied scart to cinch adaptor to connect devices to EXT 1 or 2.

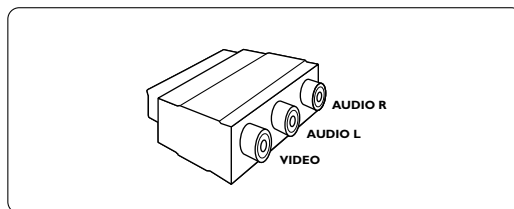

S-Video - Good quality ★★

Use an S-Video cable together with an Audio L/R (cinch) cable. Match the cable colours when you connect.

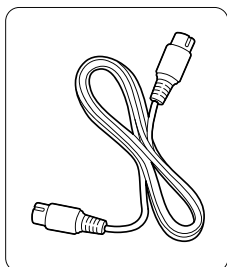

An S-Video cable

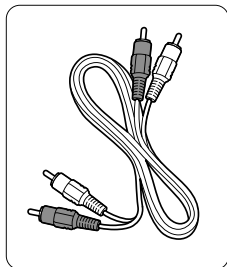

Audio L/R cable
- Red, White

Video - Basic quality ★

Use a Video (cinch) cable together with an Audio L/R (cinch) cable. Match the cable colours when you connect.

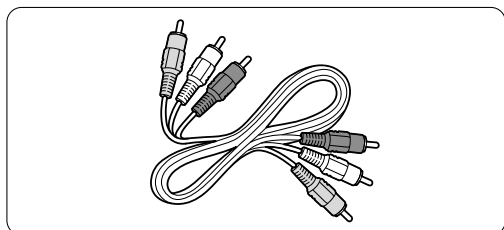

Combined Video - yellow and Audio L/R cable
- red and white

7.2.2 HDMI with EasyLink

Connected devices that are compliant with the HDMI CEC standard can work together.

- 1 Press **Menu** > TV menu > Installation > **Preferences** and press **▶** to enter the list.
- 2 Press **▲** or **▼** to select **EasyLink**.
- 3 Press **▶** to enter.
- 4 Press **▲** or **▼** to select **On** or **Off**.
- 5 Select **On** to activate EasyLink.

EasyLink might not work with devices from other brands.

One touch play

Insert a DVD disc and press Play. The TV switches on from standby and shows the DVD programme automatically.

System standby

Press the  key on the remote control for more than 2 seconds to switch the connected devices in standby.

7.2.3 Display synchronised audio out

For the best match of image and sound in speech on screen, connect a Home Theatre System to Audio Out L/R or SPDIF OUT. See diagram 7.3.7. Do not connect the audio signal of a DVD player, digital receiver or other audio/video device directly to the Home Theatre System.

7.3 Connect your devices

The connections shown in this section are recommendations for the most used cases. Other solutions are possible.

When a device is connected the TV needs to know what connection you made. See section **7.5 Setup devices**.

7.3.1 Blu-ray Disc player

For full high-definition video, connect a HDMI cable as illustrated:

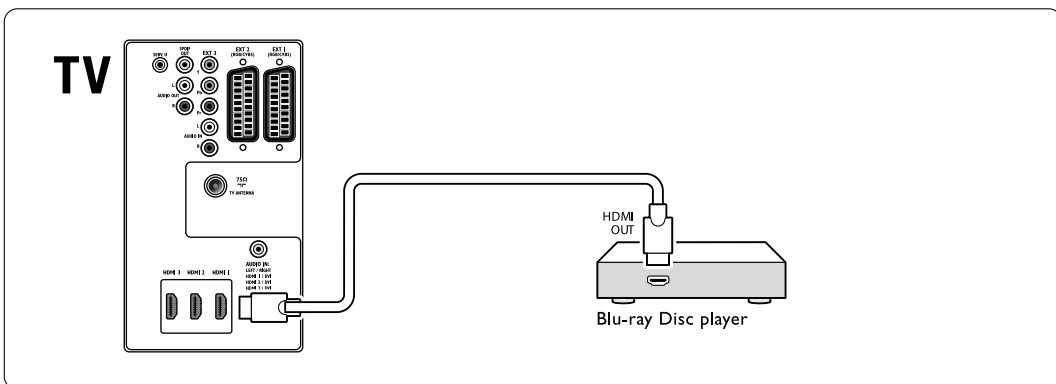

7.3.2 DVD player

For DVD video, connect a SCART cable as illustrated:

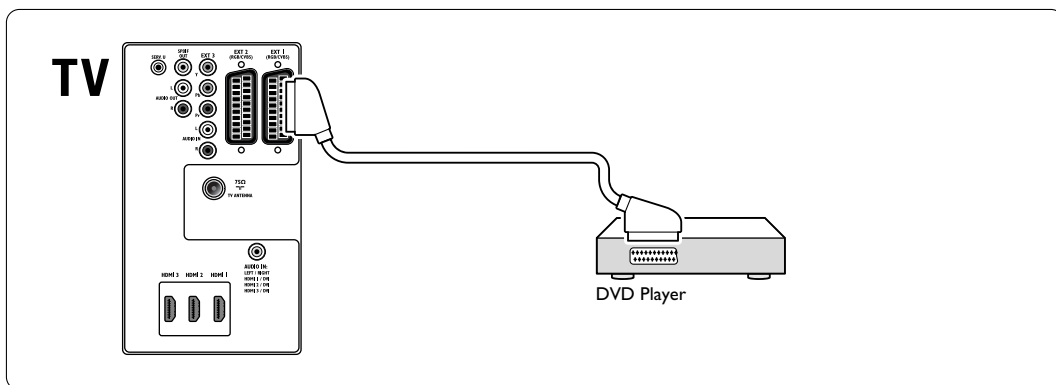

7.3.3 Satellite receiver

To receive analogue channels via antenna and digital channels via a satellite receiver; connect an antenna cable and SCART cable as illustrated:

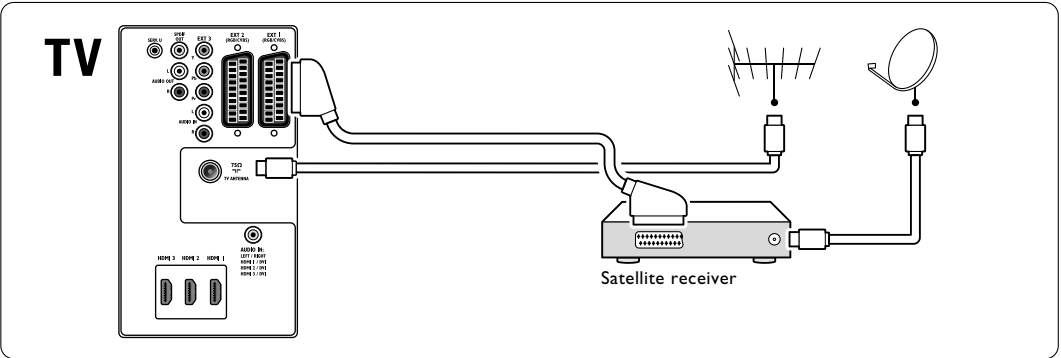

7.3.4 HD digital receiver

To receive analogue channels via antenna and digital channels via a HD digital receiver; connect two antenna cables and HDMI cable as illustrated:

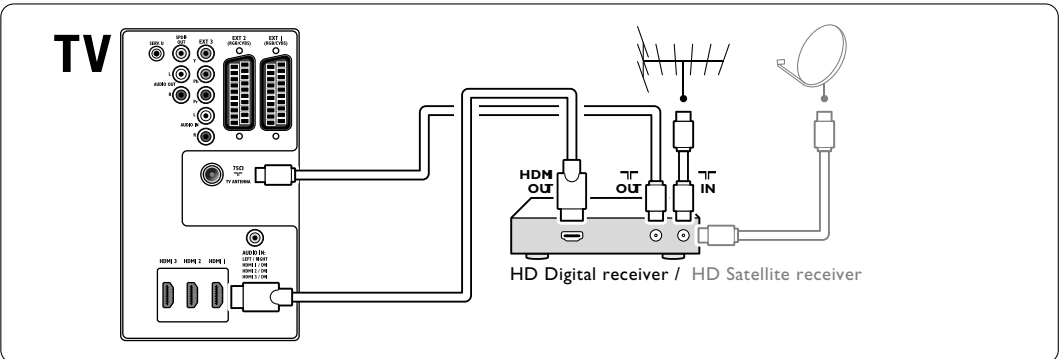

7.3.5 Combined DVD recorder and digital receiver

To receive analogue channels via antenna and record programs on a combined DVD recorder and digital receiver; connect two antenna cables and one SCART cable as illustrated:

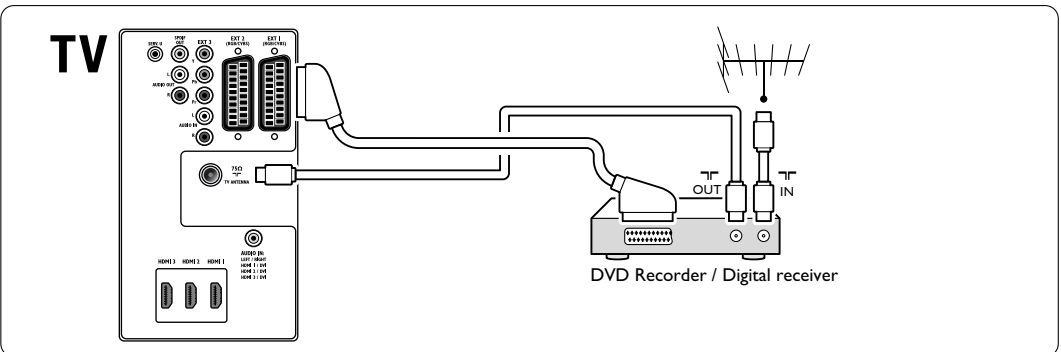

7.3.6 Separate DVD recorder and receiver

To receive analogue channels via antenna and record programmes on a separate DVD recorder and receiver; connect three antenna cables and three SCART cables as illustrated.

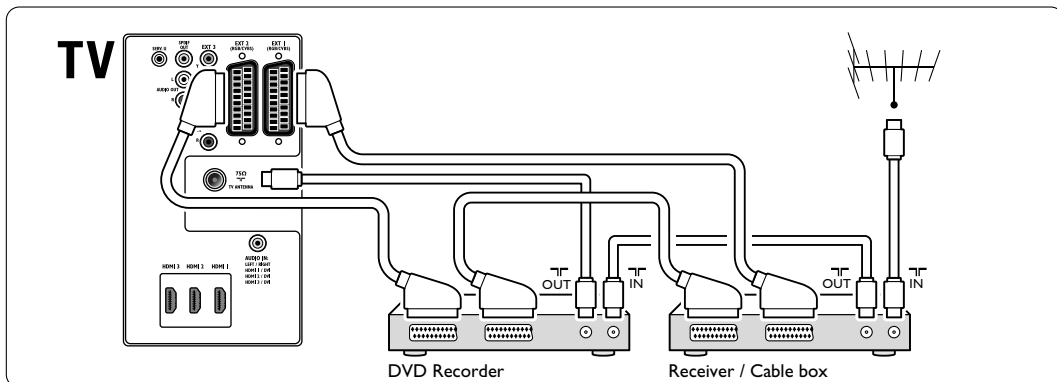

7.3.7 DVD recorder and home theatre system

To receive analogue channels via antenna, output sound to a home theatre system and record programmes on a DVD recorder; connect two antenna cables, one SCART cable and two digital audio cables as illustrated:

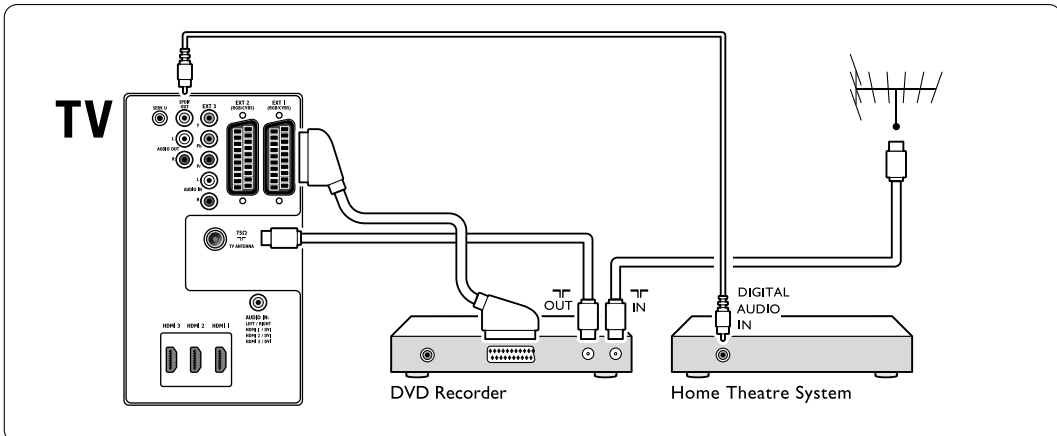

7.3.8 Game console or camcorder

The most practical connection for a mobile game console or camcorder may be at the side of the TV. You can, for example, connect the game console or camcorder to VIDEO/S-Video and AUDIO L/R connectors at the side of the TV. A HDMI connector is also available for high-definition devices.

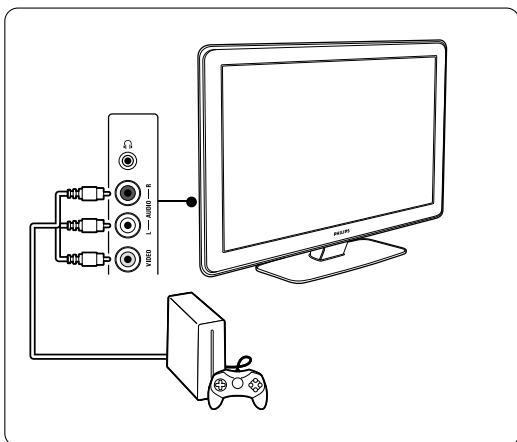

A permanent game console or camcorder can be connected to a HDMI connector or EXT 3 (component) connectors at the back of the TV.

7.3.9 Personal Computer

Before connecting the PC:

- Set the PC monitor refresh rate to 60Hz. See Section 8 **Technical specifications** for a list of computer resolutions.
- Change the TV picture format to **Unscaled** as described in Section 5.3.4. **Change picture format**.

To connect a PC to the back of the TV

- 1 Using a HDMI to DVI cable or a HDMI-to-DVI adaptor (attached to a HDMI cable), connect a HDMI connector on the back of your TV to the DVI connector on your PC.
- 2 Connect an audio cable from your PC to the AUDIO IN mini-jack connector at the back of the TV.

Note

You must assign the AUDIO IN mini-jack connector to the HDMI connector as described in Section 7.4.3 **Assign the AUDIO IN mini-jack connector**.

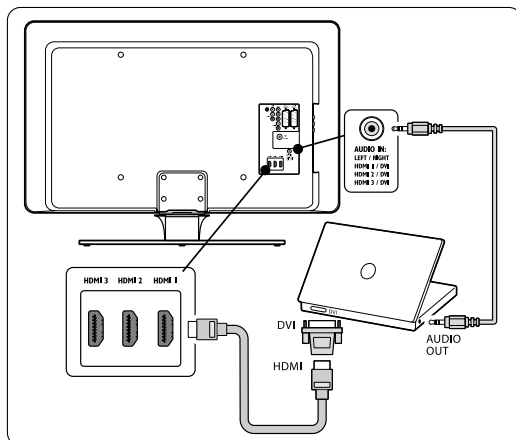

7.4 Setup devices

When all devices are connected, you must select the type of device attached to each connector.

7.4.1 Assign devices to connectors

For easy selection and best signal handling, assign the device connected to the connectors on your TV.

- 1 Press **Menu** and select TV menu > Installation > **Connections**.
- 2 Press **▶** to enter the list.
- 3 Press **▼** or **▲** to select a connector.
- 4 Press **▶** to enter the list.

Connections	EXT 1
EXT 1	None
EXT 2	DVD
EXT 3	Blu-ray
HDMI 1	HDD/DVDR
HDMI 2	HD rec.
HDMI 3	Game
Side	VCR
...	...

- 5 Press **▼** or **▲** to select the device attached to the connector.
- 6 Press **OK** to select the device.
- 7 Repeat the procedure until all devices are correctly assigned to connectors.
- 8 Press **Menu** to exit.

7.4.2 Assign the **AUDIO IN** mini-jack connector

If you connect audio from a PC to the AUDIO IN mini-jack connector at the back of the TV, you must associate it to the HDMI connector.

- 1 Press **Menu** and select TV menu > Installation > Connections > **Audio In L/R**.

Connections	AUDIO IN L/R
...	None
EXT 2	EXT 3
EXT 3	HDMI 1
HDMI 1	HDMI 2
HDMI 2	HDMI 3
HDMI 3	
Side	
AUDIO IN L/R	

- 2 Press **▶** to enter the list.
- 3 Press **▼** or **▲** to select the HDMI connector used by the PC.
- 4 Press **Menu** to exit.

8 Technical data

Supported display resolutions

- Computer formats

Resolution	Refresh rate
640 × 480	60Hz
800 × 600	60Hz
1024 × 768	60Hz
1920 × 1080i	60Hz (not for 32PFL7403D)
1920 × 1080p	60Hz (not for 32PFL7403D)
- Video formats (via HDMI/DVI input)

Resolution	Refresh rate
480i	60Hz
480p	60Hz
576i	50Hz
576p	50Hz
720p	50Hz, 60Hz
1080i	50Hz, 60Hz
1080p	24Hz, 25Hz, 30Hz
1080p	50Hz, 60Hz

Tuner / Reception / Transmission

- Antenna input: 75ohm coaxial (IEC75)
- TV system: DVB COFDM 2K/8K
- Video playback: NTSC, SECAM, PAL
- DVB Terrestrial
(see listed countries on the back of the TV)

Multimedia

- Connection: USB
- Playback formats: MP3, Linear PCM, slide show (.alb), JPEG

Remote control

- Type: RCYKF230-002B
RC2143604/01 (For 32PFL7403)
- Batteries: 2 × AAA size (LR03 type)

Connections (Rear)

- EXT 1 (SCART): Audio L/R, CVBS in/out, RGB
- EXT 2 (SCART): Audio L/R, CVBS in/out, RGB
- EXT 3: Component (Y Pb Pr), Audio L/R in
- HDMI 1/2/3

ⓘ Note

The number of HDMI connectors available may vary according to your TV model.

- SPDIF OUT: Digital audio out (coaxial-cinch-S/PDIF). Display synchronised.
- AUDIO OUT L/R: Analogue audio out.
- TV ANTENNA
- AUDIO IN: Mini-jack audio in for PC DVI-HDMI connections.

Connections (Side)

- Headphone out (stereo mini-jack)
- AUDIO L/R in
- Video (CVBS) in
- S-Video
- USB
- HDMI
- Common Interface (CAM slot)
Not currently supported by service providers in Australia.

Power

- Mains power: AC 220-240V (±10%)
- Power and standby power consumption: See technical specifications at www.philips.com
- Ambient temperature: 5°C - 35°C

Specifications are subject to change without notice.
For detailed specifications of this product go to www.philips.com/support.

9 Troubleshooting

Television and remote control

The TV does not switch on

- Verify the mains cord connection.
- Verify if the batteries of the remote control are flat or weak. Verify their + / - orientation.
You can use the keys on the TV to switch the TV on.
- Unplug the mains cord, wait for one minute and plug in the mains again.

The TV does not react on the remote control

- Verify if the batteries of the remote control are not empty or weak. Verify their + / - orientation.
 - Clean the remote control and TV sensor lens.
 - Use the side control keys to change some of the basic settings of picture and sound.
- 1** Press **Volume** - and + to adjust the volume.
 - 2** Press **Program/Channel** - and + to go through the channels marked as favourites.
 - 3** Press **Menu** to show the main menu.
Press **Program/Channel** - and + to select and adjust picture and sound menu items.

The red light on the TV blinks

- Unplug the mains cord for half a minute and insert it again. Verify if there is enough space for ventilation. Wait until the TV has cooled down. When the TV does not restart to standby and the blinking occurs again, call our Customer Support Centre.

You forgot your code to unlock Child lock

- See section **5.8.3 Set code / Change code**.

Wrong language in the TV menu ?

Follow these steps to change the language.

- 1** Press **Menu** on the remote control.
- 2** Press **▶**.
- 3** Use **▼** to highlight the third line.
- 4** Press **▶** three times.
- 5** Press **▼** or **▲** to select your language.
- 6** Press **OK**.
- 7** Press **Menu** to quit the menus.

TV channels

Some TV channels are gone

- Verify if the correct channel list is chosen.
- A channel could be uninstalled in the **Rearrange menu**.

Picture

The blue light is on, but there is no picture

- Verify if the antenna is connected properly.
- Verify if the correct device is selected.

The sound is on, but there is no picture

- Verify the contrast or brightness setting in the menu.

The TV picture is poor

- Verify if the antenna is connected properly.
- Loudspeakers, non-earthed audio devices, neon lights, high buildings or mountains can influence the picture quality. Try to improve the picture by changing the antenna direction or place devices away from the TV.
- Verify if the correct TV system is chosen in the Manual installation menu.
- If only a certain channel is poor, try to fine tune this channel in the **Fine tune** menu. See section **6.2.3**.

The picture has poor colour

- Verify the colour settings in the Picture menu.
Select any of the Reset to standard settings in the **Reset smart settings** menu. See section **5.3.2**.
- Verify the connections and cables of the connected devices.

The TV did not remember my settings when I switch back on

- Verify if the TV is set to **Home** in the TV menu > Installation > Preferences > **Location** menu.

The picture does not fit the screen, it is too big or too small

- Select a more fitting picture format in the Picture format menu.
See section **5.3.4 Widescreen picture format**.
- Name your connected device in the Connections menu to obtain the best signal handling.
See section **7.4.1 Assign devices to connectors**.

The picture position on screen is not correct

- Some picture signals from some devices do not fit the screen correctly. You can shift the picture

with the navigation key left, right or up,down on the remote control. Check the signal output of the device.

Sound

There is a picture but no sound

- Verify the volume is not set to 0.
- Verify the sound has not been muted with the  key.
- Verify if all cables are connected properly.
- If no sound signal is detected, the TV automatically switches off the sound. This is proper operation and does not indicate malfunction.

The sound is poor

- Verify if the sound is set to Stereo.
- Verify the Equalizer settings.
- Select any of the Reset to standards settings in the **Reset smart settings** menu. See section 5.3.2.

The sound comes from one speaker only

- Verify if the Balance is not set to extreme left or right.

HDMI connections

Trouble with devices connected with HDMI

- The HDMI - HDCP procedure might take a few seconds before the TV shows the picture from a device.
- If the TV does not recognise the device and the screen shows no picture, try switching from one device to another and back again to restart the HDCP procedure.
- If sound interruptions occur persistently, see the user manual of the device to verify the output settings. If that does not help, connect an additional audio cable.
- If a DVI to HDMI adaptor is used, verify if an additional audio connection is in place to complete the DVI connection.
- HDMI with EasyLink does not work
 - Verify if the connected device supports the HDMI CEC standard. See the user manual that comes with the device.
 - Verify if the HDMI cable is properly connected.
 - Verify if Easylink is activated in the TV menu, Installation, Preferences menu.
 - Ensure that the System audio control in your HDMI CEC audio devices is properly set up. See the user manual that comes with your audio device.

USB connection

The TV does not show the USB device content

- Set your device (camera) to 'Mass Storage Class' compliant.
- The USB device may need specific driver software. Unfortunately this software can not be downloaded to your TV.

I can not see my files in the Multimedia menu.

- Not all audio and picture files are supported. See section 8 **Technical data**.

Audio and picture files do not playback smoothly

- The transfer performance of the USB device limits the transfer rate.

Personal computer

The PC display on my TV is not stable or is not synchronised

- Verify if the correct resolution mode is selected on your PC. See section 8 **Technical data**.

If your problem is not solved

Switch your TV off and on again. If the problem is not solved, call the Customer Support Centre or consult our website www.philips.com/support.

See the Customer Support Centre telephone numbers on the last page of this user manual.

Please, have the TV Model and Product Number ready before you call.

You can find these numbers on the packaging label or on the typelabel on the back and bottom of the TV.

Warning

Never try to repair the TV yourself.

10 Index

100 Hz Clear LCD 5,14

A

Active Control 14
 All channels list 17
 Analogue
 Channel installation 26
 Fine tune channels 26
 Antenna
 Connect 7
 Assign
 Devices 35
 Audio language 15
 Automatic
 Channel installation 25
 Surround 15
 Volume leveling 15

B

Back connectors 4
 Balance
 Sound 15
 Brightness 13

C

Care
 Environment 3
 Screen 3
 Channels
 All channels list 17
 Change 8
 Favorite lists
 Select 17
 Setup 17
 Use 17
 Installation
 Automatic 25
 Manual 26
 Rearrange 26
 Rename 26
 Test digital reception 27
 Uninstall 27
 Update channel list 27
 Child lock
 Lock all channels/devices 19
 Lock from a certain time 19
 Lock one or more
 channel/device 19
 Set/change code 19
 Set parental rating 19

Clock 13
 Colour enhancement 14
 Component cable 29
 Composite 29
 Connections
 Back connectors 28
 Cable quality
 Component 29
 Composite 29
 HDMI 28
 SCART 29
 S-Video 29
 Devices
 Blu-ray Disc player 31
 DVD player 31
 DVD recorder/Digital
 receiver 32
 DVD recorder/Home
 theatre system 33
 DVD recorder/Receiver 32
 Game console/
 camcorder 34
 HD digital receiver 32
 PC 34
 Satellite receiver 32
 USB 21
 Philips Easylink
 Enable/disable 30
 Use 30
 Setup devices
 Assign channel decoder 30
 Assign to connectors 29
 Side connectors 28
 Contrast 13
 Custom tint 14

D

Delta volume 15
 Devices
 Watch 8
 Digital
 Radio 22
 Teletext 16
 Dual I/II 15
 Dual screen teletext 16
 Dynamic contrast 14

E

Electronic Programme Guide
 Use 18
 Environmental care 3
 Equalizer 15

F

Factory setting 27
 Favorite lists 17
 Fine tune channels 27

H

HDCP 28
 HDMI cable 28
 Hearing impaired 25
 Home mode 16
 Hue 13

K

Kensington lock 5

L

Language
 Audio 15
 Menus 25
 Subtitles 21
 Light sensor 14

M

Mains
 Connect 7
 Manual channel installation 27
 Menus
 Child lock 19
 Language 26
 Main
 Access 11
 Use 11
 Quick access 12
 Use 12
 Teletext menu 16
 Mono sound 15
 Mute 10

N

Noise reduction 12

O

On timer 19

P

- Parental rating 20
- Philips EasyLink 30
- Photos and music
 - Connect USB device 26
 - Listen to music 22
 - View photos 21
 - View slide show with music 22
- Picture
 - Adjust settings
 - Active Control 14
 - Brightness 13
 - Colour 13
 - Colour enhancement 14
 - Contrast 13
 - Custom tint 14
 - Dynamic contrast 14
 - Hue 13
 - Light sensor 14
 - Noise reduction 14
 - Sharpness 13
 - Tint 13
 - Change format 15
 - Use Settings assistant 13
 - Use smart settings
 - Current 13
 - Movie 13
 - Standard 13
 - Vivid 13
- Position TV 5
- Power
 - Connect 7

Q

- Quick access menu 12

R

- Radio channels 22
- Rearrange channels 27
- Recycling product 3
- Remote control
 - Advanced use 10
 - Basic use 4
 - Batteries 7
- Rename channels 27
- Reset to factory settings 28

S

- Safety information 3
- SCART cable 29
- Screen care 3

Settings

- Picture
 - Adjust settings 13
 - Change format 14
 - Use Settings assistant 13
 - Use smart settings 13
- Sound
 - Adjust settings 15
- Setup devices 34
- Sharpness 13
- Side
 - Connectors 4
 - Controls 4
- Sleeptimer 19
- Smart settings
 - Current 13
 - Movie 13
 - Standard 13
 - Vivid 13
- Software update
 - Check availability 23
 - Check version 24
 - Update (analogue) 24
 - Update (digital) 24
- Sound
 - Adjust settings
 - Audio language 15
 - Automatic volume leveling 15
 - Auto surround 15
 - Balance 15
 - Delta volume 15
 - Dual I/II 15
 - Equalizer 15
 - Headphone volume 15
 - Mono/Stereo 15
 - Surround mode 15
 - Volume 15
 - Stereo sound 15
- Subtitles
 - Analogue TV 20
 - Digital TV 20
 - Language 20
- Surround sound
 - Auto 15
 - Mode 15
- S-Video 29
- Switch TV
 - Off 8
 - On 8
 - On from standby 8
 - To standby 8
- System selection 26

T

- Technical specifications 36
- Teletext
 - Advanced use 16
 - Cycle subpages 16
 - Digital teletext 16
 - Dual screen 16
 - Enlarge 16
 - Language 16
 - Reveal 16
 - Search 16
 - Select subpages 16
 - Teletext 2.5 17
 - T.O.P broadcasts 16
- Timers
 - On timer 19
 - Sleeptimer 19
- Time zone 25
- Tint 13
- T.O.P. teletext 16
- Troubleshooting 37
- TV
 - Channel installation 25
 - Channels
 - Change 8
 - Favorite lists 17
 - Child lock 19
 - Connect
 - Antenna 7
 - Mains 7
 - Connections
 - Back 28
 - Devices 31
 - Quality 29
 - Side 28
 - Electronic Programme Guide 18
 - Get started 5
- Main menus
 - Access 11
 - Use 12
 - Overview 4
 - Photos and music 21
 - Position 5
 - Ideal distance 5
- Quick access menu
 - Use 12
- Remote control
 - Advanced use 10
 - Basic use 4
 - Batteries 7
 - Reset to factory setting 27
 - Side controls 4
 - Software update 23

- Stand 6
- Subtitles 20
- Switch
 - Off 8
 - On 8
 - On from standby 8
 - To standby 8
- Teletext
 - Advanced use 16
 - Basic use 9
- Timers
 - On timer 19
 - Sleeptimer 19
- Volume 8
- Wall mount 6
- Watch
 - Channels 9
 - Devices 9

U

- Uninstall channels 27
- USB device
 - Connect 21
 - Disconnect 21

V

- VESA wall bracket 6
- Video formats 36
- Volume
 - Adjust 8, 15
 - Automatic leveling 2115
 - Delta 15
 - Headphone 15

W

- Wall mount TV 6

Y

- Y Pb Pr 29



Contact information

Type no. _____

Product no. _____



Australia
1300 363 391



Specifications are subject to change without notice
Trademarks are the property of Koninklijke Philips Electronics N.V.
or their respective owners
2008 © Koninklijke Philips Electronics N.V. All rights reserved

www.philips.com



Printed in Belgium